



Approved For Use With

TRAVELLER™
Science-Fiction Adventure in
the Far Future

ACS-4

Adventure Class Ships, Volume 4 – Aslan Mercenary Ships

Warlord Quarter Deck
Warlord Command Deck
Warlord Battle Deck

Hero Class Engineering Deck
Hero Class Troop Decks
Hero Class Main Deck

Includes

Adventure Class Ships Volume III, Book 1-

Adventure Class Ships Volume III, Book 2-

Edited to include Deck Plan Images within the text.

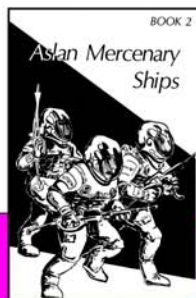
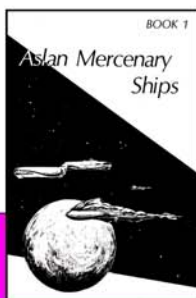

www.farfuture.net

BOOK 1

Aslan Mercenary Ships





ACS-4

Copyright © 2009 Far Future Enterprises

UPDATED AND RE-EDITED

The text of this book has been re-edited to correct obvious errors, and reformatted to include smaller deck plans for reference. The Deck Plans have been edited for clarity.

Copyright © 1982, by FASA
All Rights Reserved.
Printed in the United States of America

No part of this book or accompanying drawings may be reproduced in any form, or by any means without written permission from the publisher.

Traveller is Game Designers' Workshop's trademark for its role-playing game of science-fiction adventure in the far future. The Traveller trademark and selected materials contained in this adventure are used under license.

Published by FASA
P.O. Box 6930
Chicago IL 60680-6930

A catalogue of other FASA products may be obtained by mailing a self-addressed, stamped envelope to the address above.

Produced at Game Center Institute, Chicago.

Writing J. Andrew Keith
Aslan Development and General Assistance William H. Keith, Jr.
Frank Chadwick, John Hershman, Loren K. Wiseman

Intruder Transport Design and Conception Jordan Weisman
Battle Leader Design and Conception Ross Babcock
Intruder Transport Drawn by Jordan Weisman
Battle Leader Drawn by Ross Babcock
Art Work by William H. Keith Jr.

Material on the Aslan is taken from Supplement 8, Library Data and other sources published by Game Designers' Workshop. Copyright © 1981 by Game Designers' Workshop. This material is used with permission.

The Reaver's Deep sector in which adventure situations have been set has been assigned to Marischal Adventures for development and use, and appears here by permission.

INTRODUCTION

The shipyards of Roaa (Uhtaa 0706) are famous throughout the Reavers' Deep region as the source of some of the finest examples of shipbuilding found in the Aslan Hierate. Owned and operated by Larleaftea Hryawaowya, an Aslan commercial concern with interests in everything from shipbuilding to interstellar trade, Roaa's shipyards are an important place from which many Aslan clans and companies buy ships for a wide range of uses — local trade, exploration, military operations, and just about every other aspect of travel between stars.

The two ship types discussed in this booklet are vessels manufactured for sale to mercenary units and clan military forces. Shown here in one of four "standard" configurations, the ships can also be tailored to suit individual client needs (at a considerable extra cost). The standard formats, however, are designed for maximum flexibility, and have proven quite popular. Other models trade off vehicle space for additional low berths, provide weaponry tailored to combat in space, rather than ground support, or otherwise slightly alter facilities to adapt to various extra requirements.

Ships of this type have been acquired by the Teahleikhoi regiment discussed in "The Aslan at War" booklet which accompanies this set, and are typical of those that might be encountered by Traveller adventurers.

Hero Intruder Transport

Intruder Transport	IT-C1347G2-900500-45009-0	MCr2887.1	3000 tons
batteries bearing	64 2	Crew=55	
batteries	64 2	TL=14	

Passengers=0. Low Berths=190. Fuel=1110. EP=210. Agility=4. Marines=253.
Tonnage: 3,000 tons (standard). 42,000 cubic meters.

Crew: 12 officers, 43 enlisted personnel.

Performance: Jump-3. 4-G. Power Plant-7. 210 EP. Agility 4.

Electronics: Model/7fib computer.

Hardpoints: Two 50 ton bays. Ten hardpoints.

Armaments: Two 50-ton missile bays. Six triple beam laser turrets.

Four double fusion gun turrets. Turrets are separately controlled to allow independent fire.

Defenses: Nuclear Damper (factor-5). Armored Hull (factor-9).

Craft: Two 20-ton launches. 6 air/raft bays. Eight 10-ton vehicle bays.

Fuel Treatment: Ship is equipped with fuel scoops and on-board fuel purification plant.

Cost: MCr 2887.1 standard. MCr2309.68 in quantity.

Construction Time: 34 months singly. 23 months in quantity.

Comments: Designed to transport and support a full company of mercenary troops and their equipment, the Eiaikeiar (usually translated as "Hero"; also "Honored Warrior", "Valorous Conqueror", etc.) class Intruder Transport is an excellent example of Aslan ship-building at its' finest. The vessel is built not just to transport troops to the field of battle, but also to give them support once they arrive. Intended for a broad range of mercenary duties, the ship is completely self-sufficient. It is not, however, well-suited for deep space combat situations. Against well-coordinated orbital or planetary defenses, or a fighting ship of the same size, the Intruder Transport fares very poorly indeed.

In its role as a mercenary transport, however, delivering troops and supporting them in action, the ship performs quite well. It is often employed singly, but can be encountered in the company of other ships where more force is deemed necessary.

The Intruder Transport can carry 63 troops in cabins and bunkrooms, plus 190 individuals in low berth, for a total of 253. Mercenary troops carried on board vary from one unit to another. If using the company outlined in the other booklet, "The Aslan at War", an Intruder Transport will carry the following personnel.

One platoon (41 individuals) is kept out of low berth for shipboard security duties, so one unit is always combat-ready. Three other combat platoons are kept in low berth. An additional unit — attached for support or additional firepower as needed — may also be present.

All officers in the unit — from the company commander down to the leaders of each platoon — remain awake at all times, as does the company NCO. Four medical people and ten mechanics are also kept on standby. All other troops, including additional non-combatant personnel, are kept in low berths until the ship arrives at a new destination.

The presence of an owner's agent on board will displace one of the ship's senior officers, causing a doubling up somewhere in the accommodations. Such an agent will be present any time the ship is operating away from the main unit.

INTERIOR LAYOUT

The deck plans for the Intruder Transport are included on the accompanying set of 22 x 34 inch sheets. A square grid has been overlaid on the ship plans to allow use with **GDW's** *Snapshot* and *Azhanti High Lightning* games. The scale is the standard *Traveller* 1.5 meter square. Other important symbols and codes are shown on the map key.

COMMAND DECK

The uppermost deck of the Intruder Transport is the Command Deck. The Bridge is the main feature of this level. Forward, a large window dominates the compartment, while control consoles ring the remainder. The positions are as follows:

1. Captain. All command functions can be monitored and controlled from here.
2. Executive Officer: This position is used by the female in charge of ship's administration. It monitors most of the same functions as the command console, and has provisions for coordinating non-combat ship functions.
3. Helm. Occupied by one of the pilots.
4. Navigation. Occupied by one of the pilots.
5. Communications. Occupied by the Commo Officer as required.
6. Computer. Occupied by the Computer Officer as required.
7. Engineering. Occupied by the Engineering Officer as required.
8. Battlefield Liaison. Occupied by a female staff officer from the ship's mercenary contingent during combat. The console is used to coordinate ship and ground activities, and, when engaged in combined operations, also links to other vessels in a squadron.

The Bridge is fully crewed only during combat. Normal watchkeeping in Deep Space requires Helm, Navigation, and Computer stations to be manned. In jump, only the latter two are required. Other positions may be occupied, or not, as dictated by the situation.

Aft of the Bridge are two single cabins, one for the captain, the other for the Executive Officer. The Captain's cabin contains sleeping quarters, a dayroom, and a meditation chamber, plus the usual amenities and facilities. The female Exec has a similar cabin layout, but the meditation room is replaced by an office from which she directs routine administrative chores. This office area includes a computer terminal and intercom links to keep the Exec in contact with various parts of the ship.

Running between the two cabins, and abaft the elevator leading below, a small alcove contains the ship's Shrine of Heroes. Memorials to the ship, its crew (past and present), and troops carried on board who have distinguished themselves are all contained here. It is a place of meditation and reverence, open to anyone aboard the ship; the small chamber plays an important part in Aslan tradition by keeping alive the memory of past heroes. Computer records can produce holographic sound-and-sight recordings of distinguished individuals or even famous battles, which occupants of the chamber can then study and contemplate. Individuals within this alcove are never disturbed; to do so is a great outrage to Aslan tradition.

CREW DECK

The second deck is given over almost entirely to quarters for the ship's officers and crew. Officers are quartered aft, petty officers and ratings forward; there is, however, very little distinction of class between the two groups. Only the most senior officers (the Department heads) have single cabins. Other officers, as well as enlisted personnel, have doubles. Officers and crew share the common area in the after section of the deck, which is used as a mess hall and relaxation area open to all. Aslan traditions tend to minimize differences in rank, stressing the idea of shared danger and shared rewards for all. This attitude promotes a healthy morale and feeling of camaraderie that unites all on board into a smooth, well-oiled unit.

Also located on this deck are the ship's six triple laser turrets.

TROOP DECK

This deck is largely devoted to transport of the contingent of mercenary troops carried on board the Intruder Transport. While most of the company is kept in low berth between active operations, one full platoon is kept awake during transit, ready to function if needed as ship's troops for offensive or defensive boarding actions, or in any situation where military personnel are needed more quickly than low berth transportees can be revived, equipped, and briefed.

The use of low berth transport for the majority of the company is an essential economic factor in the operation of the ship. The need to carry the maximum number of fighting soldiers with the least possible investment in supplies, life support, and overall space makes it impractical to carry a large force in any other fashion. Smaller units would be far less desirable, as such forces cannot accomplish as much. Thus the need to commit a large portion of the unit to low berth for each voyage.

During transit, all officers are kept awake, including platoon leaders whose platoons are not on security duty. This is done so that the unit's leadership can be kept fully aware of developing situations, thus cutting down considerably on briefing times once action is underway. The entire company can function with maximum efficiency as a battle develops as a result of this practice. Medical and support personnel stay active to look after the unit's health and equipment.

The largest single area on the Troop Deck is a platoon bunkroom holding the individuals currently performing shipboard security duty. Thirty-nine soldiers bunk in the area. Offices, locker space, and other small compartments open off the main bunkroom. A number of double cabins surround the bunkroom proper, for use by various other individuals kept awake during voyages.

A block of three cabins is set aside for the company's leadership. The Company Commander — a male — has a single cabin. An adjacent cabin houses the female Company Adjutant, while a third holds two junior female staff officers.

Also present on the Troop Deck is the ship's Sick Bay, a briefing area and wardroom for company officers, a galley, and a gymnasium used by bored warriors during the long periods in space to keep fit and active. The active duty platoon spends a great deal of time working out here.

In addition to troop quarters, the deck contains the uppermost of the engineering spaces on board. Jump Drive and Power Plant machinery predominate. Very little of the area is actually accessible, except through crawl spaces and access panels. Monitor consoles are present in several locations, however. Engineering watchstanders are usually females or males of low social level.

Finally, the forward section of the troop deck holds the upper missile bay. In combat, the Chief Gunnery Officer is stationed here. Overall coordination of firepower is relayed from the Bridge (where the captain and the Battlefield liaison operator are responsible for responding to ground and squadron orders concerning application of ship's weaponry). Actual operation of the two missile bays — plus communication with the various gun turrets) is run from here, however.

Four double fusion gun turrets are also located on this deck, two to port and two to starboard. They are independently directed as required.

ENGINEERING DECK

The Engineering Deck — actually only one of the three decks containing engineering equipment — is the largest single deck of the Intruder Transport. Much of the deck is set aside for the ship's Manuever Drives, with additional space devoted to power plant and jump drive machinery. Fuel scoops, fuel purification plants, and fuel tankage are also present. As with other decks containing engine spaces, access is mostly by crawl spaces: there are, though, several monitor consoles at various points.

Forward of this area are two low berth sections, each able to hold 78 troopers stacked four-high. This allows the equivalent of four platoons — the majority of the troops carried on board — to be housed here. A ready room and general storage compartment are also provided here to allow rapid mustering and equipping of troops as they are revived. The ready room doubles as a common area for the duty platoon during interstellar voyages, and has galley space available.

Airlocks and ship's lockers for EVA operations are located forward of this ready room area. They are used strictly for space operations; exit on planetary surfaces is through the various ramps on the Vehicle Deck.

HERO IT - C1347G2 - 900500 - 45009 - 0 MCr 2879.35 3000 tons
 batteries bearing 64 2 Crew - 55.
 batteries 64 2 TL - 14.
 Passengers - 0. Low Berths - 190. Fuel - 1110. E.P. - 210. Agility - 4.
 Marines - 253. Launches - 2. Vehicle Bays - 8. Air Rafts - 6.

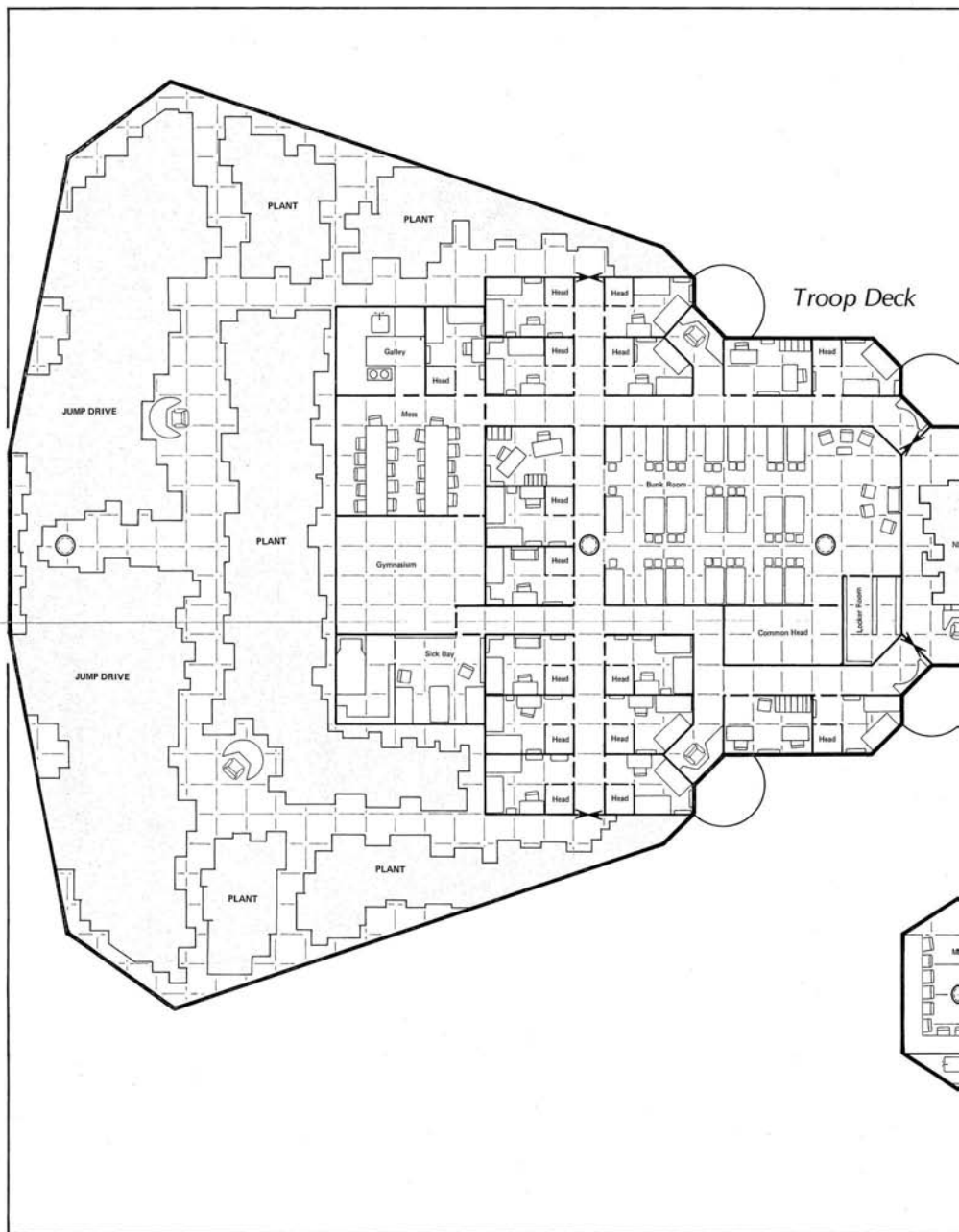

Crew, Troop, Command Decks

Hero Class Intruder Transport

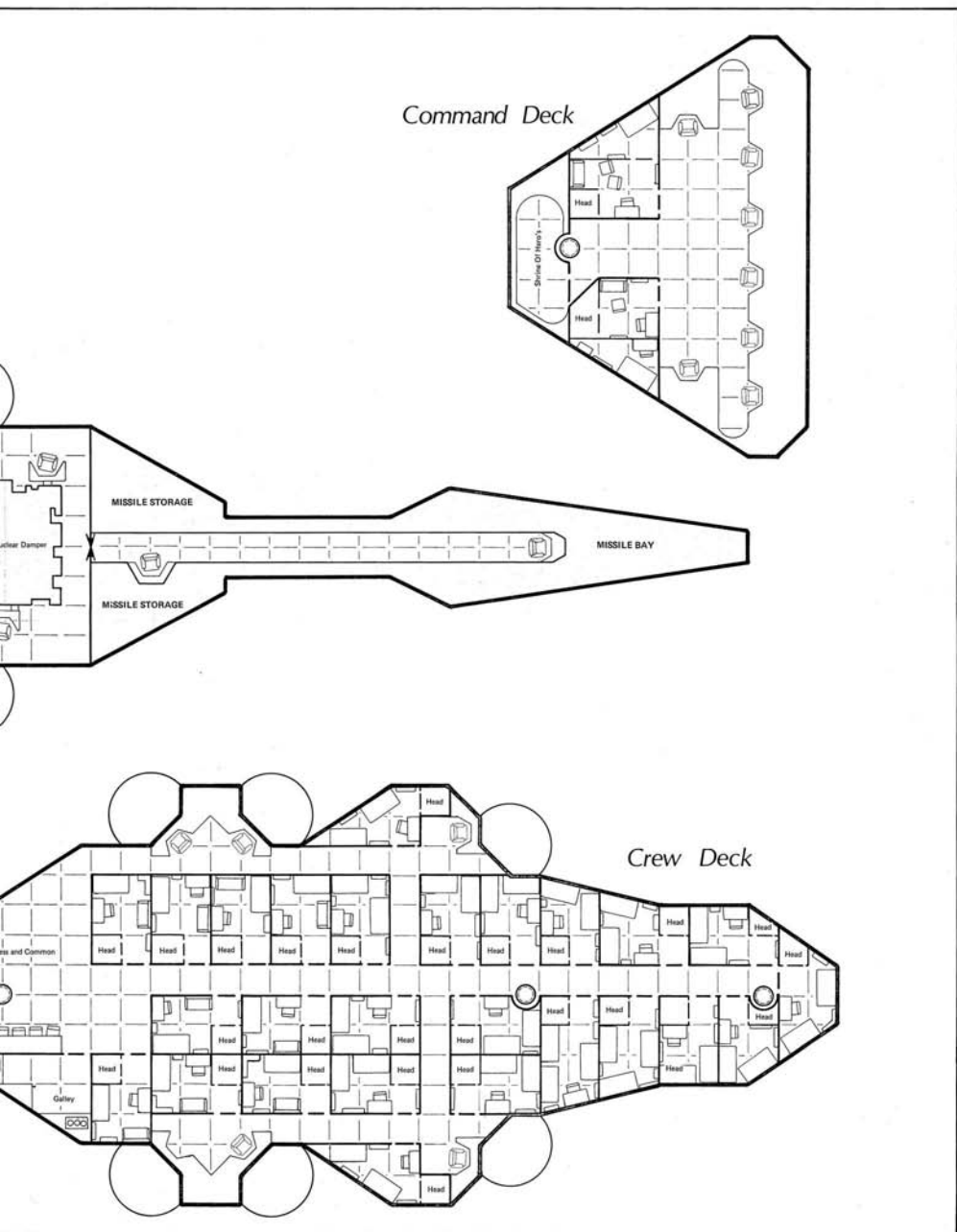

HERO IT - C1347G2 - 900500 - 45009 - 0 MCr 2879.35 3000 tons
 batteries bearing 64 2 Crew - 55.
 batteries 64 2 TL - 14.
 Passengers - 0. Low Berths - 190. Fuel - 1110. E.P. - 210. Agility - 4.
 Marines - 253. Launches - 2. Vehicle Bays - 8. Air Rafts - 6.

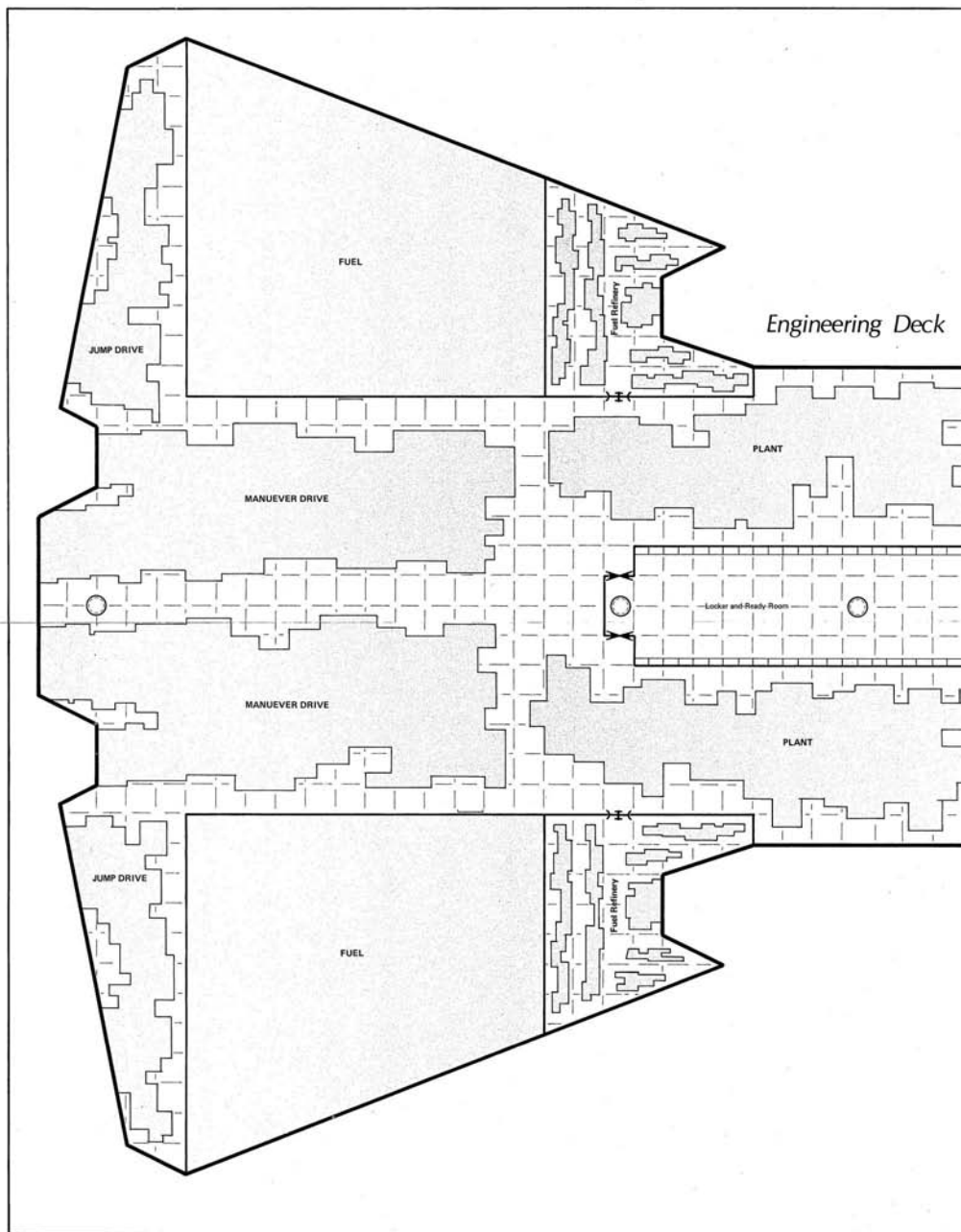

Engineering Deck

Hero Class Intruder Transport

Hero Class Intruder Transport

HERO IT - C1347G2 - 900500 - 45009 - 0 MC: 2879.35 3000 tons
 batteries bearing 64 2 Crew - 55, TL - 14,
 batteries 64 2
 Passengers - 0, Low Berths - 190, Fuel - 1110, E.P. - 210, Agility - 4,
 Marines - 253, Launches - 2, Vehicle Bays - 8, Air Rafs - 6.

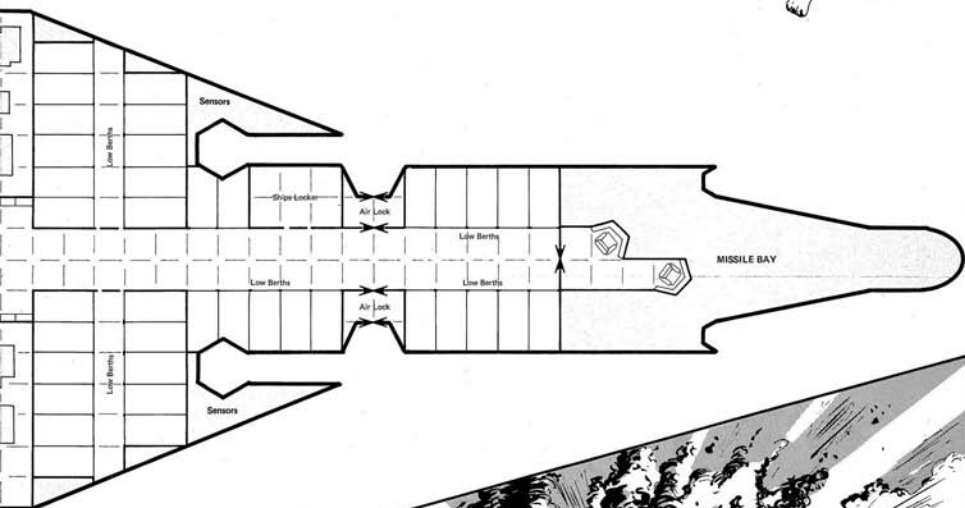

HERO IT - C1347G2 - 900500 - 45009 - 0 MCr 2879.35 3000 tons
 batteries bearing 64 2 Crew - 55.
 batteries 64 2 TL - 14.
 Passengers - 0. Low Berths - 190. Fuel - 1110. E.P. - 210. Agility - 4.
 Marines - 253. Launches - 2. Vehicle Bays - 8. Air Rafts - 6.

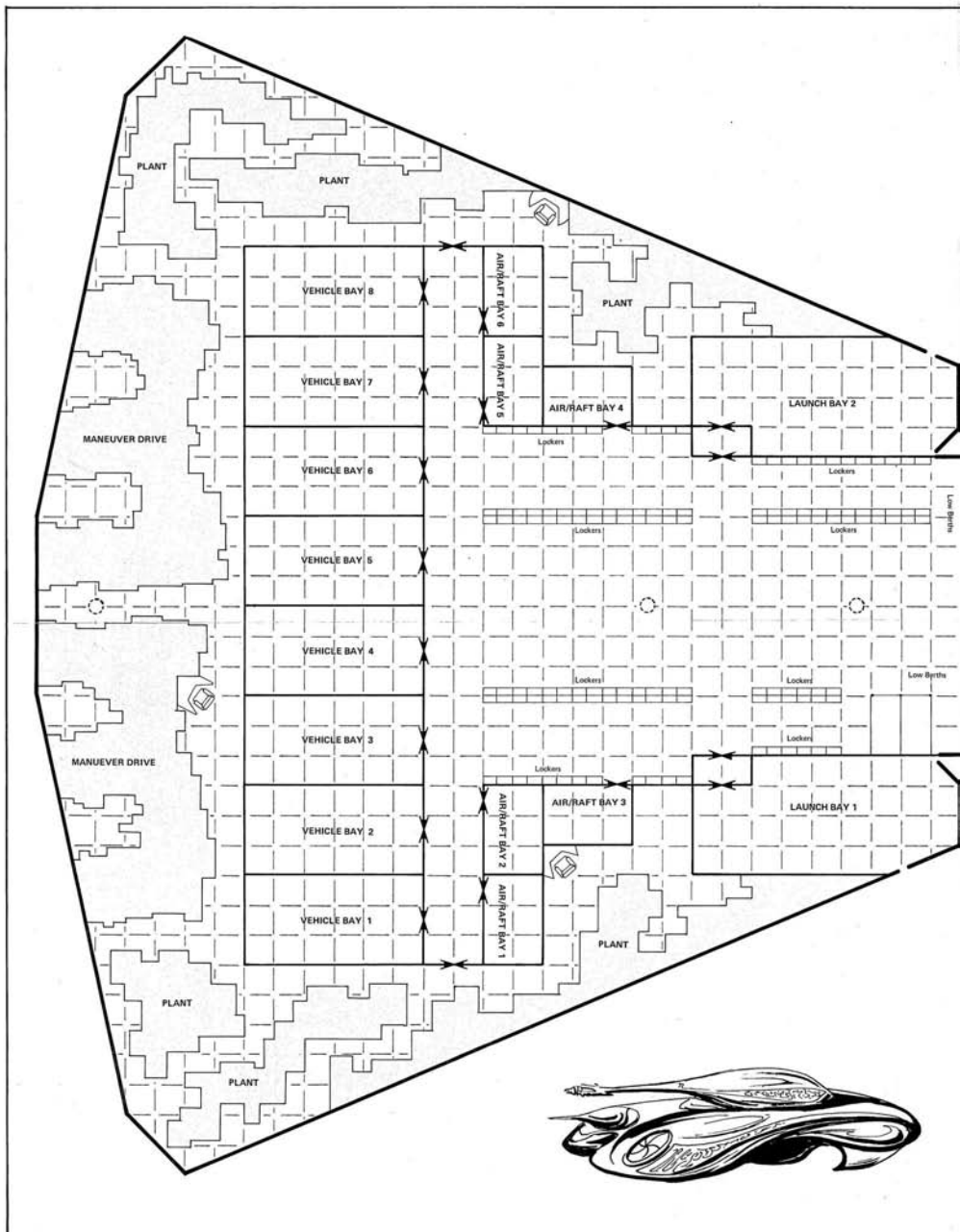

Vehicle Deck

Hero Class Intruder Transport

Hero Class Intruder Transport

HERO IT - C1347G2 - 900500 - 45009 - 0 MCr 2879.35 3000 tons
 batteries bearing 64 2 Crew-55
 batteries 64 2 TL-14
 Passengers 0 Low Berths-150 Fuel-1110 E.P.-210 Agility-4
 Marines-263 Launches-2 Vehicle Bays-8 Air Rafts-6



INDIRECT FIRE SUPPORT VEHICLE THUNDERER

The vehicle has a crew of 3 (commander, driver, gunner); no passengers are carried. It holds twin MRL in remote mounts on the chassis deck, plus a VRF gauss gun for anti-personnel purposes. It has tech 14 indirect fire control. Height: 3m. Width: 4m. Length: 10m. Total volume: 120 m³. Weight: 200 tons. Price: Cr 2,871,720 (with out extra equipment).

Movement: Maximum, 600 kph/500 cm; cruise, 450 kph/375 cm NOE, 190/120 cm.
 Movement Effects on Fire: None.
 Armor: Chassis front, 56. Chassis sides and rear, 45. Belly and deck, 40.

Target Size DM: +4 low.
 Equipment: Basic equipment includes Tech 14 avionics, sealed environment with life support for 3, and 10 tons cargo capacity. Additional space can house up to 3 cubic meters of additional electronic equipment and other gear.

Power: 21.5 megawatt fusion power plant consumes 47.25 liters of fuel per hour; fuel capacity is 5875 liters, enough for five days (120 hours).

Weapons: Characteristics of the VRF gauss gun are given on the crewed weapons: slug throwers table. The vehicle carries 20 loaded hoppers for the weapon. The twin MRLs, 25-tube MRLs fire 8 kg rockets with an IOP of 25 miles. Range characteristics are as follows:

Short Range Rocket	Medium Range Rocket	Long Range Rocket
5.25	9.5	14.0

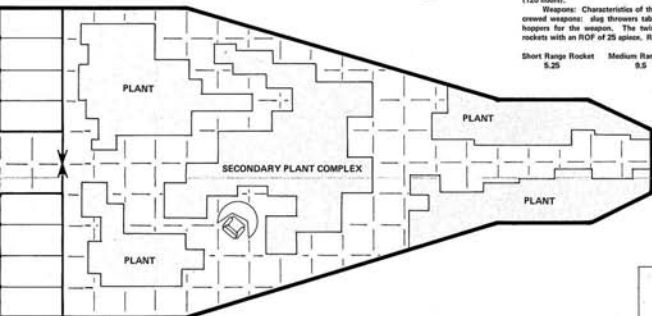

ASLAN 20 TON LAUNCH

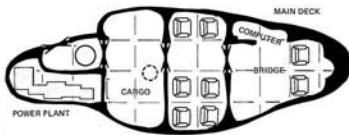

DIRECT FIRE SUPPORT VEHICLE LIGHTNING

The vehicle has a crew of 3 (commander, driver, gunner); no passengers are carried. The turret mounts a 40 mm input beam laser. Two VRF gauss guns are also carried on board. It has tech level 14 direct fire control. Height: 3 m (1 turret, 1 rail). Width: 4 m. Length: 10 m. Total volume: 98 m³. Weight: 185 tons. Price: Cr 3,274,500 (without extra equipment).

Movement: Maximum, 720 kph/600 cm; cruise, 540 kph/450 cm NOE, 190 kph/150 cm.
 Movement Effects on Fire: None.
 Armor: Chassis front and sides, 47. Chassis rear, 46. Deck and Belly, 45. Turret (all round), 55.

Target Size DM: +3 low, +1 high.
 Equipment: Basic equipment includes Tech 14 avionics, sealed environment with life support for 3, and 15 tons cargo capacity. Additional space can house up to 4 cubic meters in additional electronics and other gear.

Power: 72 megawatt fusion power plant consumes 108 liters fuel per hour; fuel capacity is 13,050 liters, enough for five days (120 hours).

Weapons: Characteristics of the VRF gauss gun are given on the crewed weapons: slug throwers table. The vehicle carries 20 loaded hoppers for each weapon. The 40 megawatt input beam laser may engage 2 targets, and is automatically spotted when it fires. Range and penetration are given below.

Effective	Long	Extreme
7.75(54)-1-2	15.5(54)-1-2	31.4(40)-2

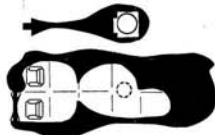

The forward portion of the deck holds the lower missile bay, plus the ship's nuclear damper. These are under the command of the junior Gunnery Officer, who is also ready to take command of the ship's firepower if circumstances warrant.

VEHICLE DECK

The lowermost deck of the Intruder Transport contains the storage bays for eight ten-ton vehicles used by the mercenary contingent. These vehicles are designed along various lines, according to the needs of the unit. The basic requirements for the Teahleikhoi regiment's vehicles are described in "The Aslan at War", and can be considered typical. Among the vehicles carried aboard, in addition to regular fighting vehicles, it is possible to find medical, supply, or engineering vehicles; other possibilities, too, exist. It is recommended that interested referees or players design such vehicles according to the rules given in GDW's Striker. The limit of 10 tons (displacement) means that such vehicles will be no more than 140 cubic meters in volume, and will frequently be smaller.

The vehicle bays open to the outside directly and individually. Ramps lower from the bottom of each bay separately. Wheeled and tracked vehicles drive down these ramps, while grav vehicles leave by flying. The bays serve as additional exits for troops once vehicles have unloaded.

Six air/rafts are always carried aboard the Intruder Transport, regardless of other vehicles carried. These are used as described in "The Aslan at War" by the mercenary force. Air/rafts are kept in separate compartment, and can be dropped directly from the underside of the ship. As they are grav vehicles, no ramps are provided, and air/raft bays cannot be used for debarking troops or other equipment.

Thirty-four individuals are kept in low berth on the Vehicle Deck; these are usually noncombatant personnel. A ready room for combat troops is also present on the deck. Twin ramps drop down from either side of the ready room area to allow troops to debark onto a planetary surface. There is enough room in this area to muster four platoons at any one time prior to unloading.

Two 20-ton launches are docked forward of this area, one on each side of the deck. During planetary combat these launches are often out of the ship, operating as recon craft, providing close support, and most often, transferring supplies and occasional personnel from the ship to the ground.

Most of the remainder of the deck, aft of the vehicle bays, holds maneuver drive and power plant machinery.

Launch GG-0204411-000000-20000-0 MCr10.85 20 tons
Crew=2. Passengers=6. Cargo=6. Fuel=1. Agility=0. TL=14. One battery.

CONDITIONS ON BOARD

Standard conditions aboard the Intruder Transport are not very different from those aboard any other starship. Internal gravity, climate, lighting, and other factors are very close to the human norm.

Controls, consoles, and notices posted throughout the ship are, of course, written in Aslan. Humans are unlikely to be able to puzzle out the meaning of such written messages without prior knowledge of the language. The referee should establish this fact before such a situation comes up.

KAIHEIAR DOWN

Background: Ildrissar (Drexilthar 0706 C995836-7), a planet of the Carilian Assembly, was a quiet frontier world not unlike dozens of others in 'Reavers Deep. When High Justice Daldreem assumed power in violation of the Articles of Assembly, however, the people of Ildrissar staged a planet-wide uprising in protest. Daldreem sent in troops stiffened by a crack Aslan mercenary regiment. The provisional government on Ildrissar also brought in mercenaries, two battalions of the Caledon Highlanders, a famous human mercenary unit.

The Aslan-backed Assembly forces seemed unstoppable. Securing landing areas in the isolated wilderness northwest of the main settled region on Ildrissar's largest continent, the invaders launched a drive towards the heart of the colony. They were held up for a few days at Deathgorge Pass, but the outnumbered defenders were soon overwhelmed; the Aslan forces were largely responsible for the rebel defeat.

After Deathgorge Pass, the campaign hinged around the control of a number of strongpoints guarding the approaches to the capital. The Aslan assigned one company to each of the key stongholds. The unit attached to the Intruder transport Kaiheiar was dispatched against Duracenday, with the ship filling a ground support role. Opposing the Aslan and the Assemble troops cooperating with them was a small rebel force augmented by a portion of Third Platoon, Recon Company of the Caledon Highlanders, commanded by Lieutenant James Hamilton.

During the early portions of the battle for Duracenday, fortune seemed to smile on the rebel cause. The rebel defenses were strong, although the troops available were outnumbered. The balance shifted in favor of the defenders when a tac missile scored a lucky hit on Kaiheiar's maneuver drive as it made a pass over the town. Radar tracked the ship to a landing some 30 kilometers away; it was soon plain that the hit had taken the ship out of action for at least a short time, while repairs were made.

Hamilton's unit was equipped as a recon platoon with grav belts, chameleon combat armor, and advanced combat rifles. The rebel commander at Druacenday ordered Hamilton to go out and investigate the downed transport, and, if possible, to see to it that the ship stayed out of action for a while longer. A relief column was on its way, and other invading troops were, for a time, too heavily engaged to support the Assembly forces around the town. If the ship could be kept out of the upcoming battle, there was a good chance that Duracenday would hold.

Slipping out of the city at night on silent grav belts, Hamilton's men moved to take up a position on a ridge overlooking the damaged ship. She was lightly defended, for the moment, and a planned rebel sortie towards dawn would hopefully keep the forces around town tied down while Hamilton did his work.

Hamilton must get his men on board and cause as much damage as possible, crippling the grounded transport to keep it from escaping as the relief force advanced. The humans are outnumbered, but have the advantages of surprise, coordination, and high morale. With a final scan of the site through LI goggles, Hamilton orders his men to make their move . . .

REFEREE'S NOTES

The Raiding Party: Adventurers in the human force should be drawn from Army or Marine backgrounds; use of Traveller Book 4, Mercenary, is strongly encouraged for character creation as well as equipment and weapons. The team may number up to twenty men, with the referee controlling non-player characters as needed. One player-character should be Lieutenant Hamilton, commander of the force.

James Hamilton (Army 1st Lieutenant) 9B8AA9 Age 30 3 terms (elite)
Tactics-3, Leader-3, Recon-2, Combat Rifle-2, Pistol-2, Grav Vehicle-1, Domoli-
tions-1.

If using Striker, members of Hamilton's force should be considered Picked Troops (Hamilton is elite, with a morale of 13). The unit may be organized as desired by the players or designated by the referee. Equipment should be, basically, what was mentioned in the background notes, although some additional equipment may be allowed.

The Aslan: The referee should set up the Aslan crew aboard the Kaiheiar secretly, determining locations of everyone present prior to the start of the attack. The entire crew, plus seventeen troops, are on board. ¹ Crew members may be set up according to the guidelines listed on the crew roster, though variations are allowed. The referee is allowed discretion on placement of those for whom no specific station is given, but all should be set up in logical positions for a group not expecting a raid. The engineering crews should be set up either in appropriate engine spaces or outside the ship, working on the damaged maneuver drive.

Entry: The raiders may attempt to force entry at one of the ship's airlocks or the ramp doors on the lower deck. These are closed at the start of the situation, but each half hour one will open for technicians or troops to enter or leave the ship on a roll of 9+. The referee should designate which door opens at any particular time. A third alternative is to use explosives, which the party should be carrying, to open a suitable hole. The referee should handle the use of explosives; the rules in Mercenary and in Striker are also helpful. Once entry is achieved, use the deck plans to resolve the course of combat inside the ship.

The Raid: Combat aboard should be conducted in accordance with rules from *Snapshot*, *Azhanti High Lightning*, or, if the referee is willing to make necessary conversions of scale, *Striker*. The counters provided in this package are suitable for use as the defenders in this scenario; attackers may be represented by unused counters or by extras gleaned from other games (*Azhanti High Lightning* is a good source), Martian Metals TRAVELLER miniatures may be substituted.

The adventurers must attempt to reach the bridge or one of the power plant or maneuver drive engineering areas and destroy as many control consoles as possible. Demolitions or the collateral damage rules outlined in Azhanti High Lightning are both feasible ways to render controls inoperative. Failing either of these accomplishments, damage to gun turrets and the gunnery control area will, at least, render the ship useless for supporting ground forces.

Aslan Reactions: The Aslan crew is attempting to make their ship functional again. Unless the humans cause damage as outlined above, the technicians will be successful during any period of ½ hour in which the referee rolls a 10+. Once repairs are made, the ship will lift off, unless prevented by destruction of controls or sole human occupation of the Bridge.

Aslan morale is treated in accordance with Striker and the information presented in these two booklets.

Reinforcements: When the element of surprise is lost, either through explosions or gunfire being heard, a crew member sighting raiders and escaping, or a sentry or other individual being attacked but not silenced, the Aslan will attempt to summon reinforcements. These will be free to rally to the ship on a roll of 9+; they will appear in 1D x 10 minutes. The number of reinforcements is left to the referee who must balance excitement against fair play.

Prior to a distress call, extra Aslan troops — a grav vehicle, an air/raft, or, perhaps, a foot patrol — may arrive on the scene anyway. This occurs on a roll of 11+, made once each half hour.

Resolving the Situation: The scenario is completed whenever one of the following conditions is fulfilled:

1. The human force is wiped out or captured.
2. All Aslan on board are wiped out or captured.
3. 100 damage points are inflicted to bridge control consoles or any one console in the maneuver drive or power plant areas of the ship, and the humans escape.
4. All 10 gun turrets and the controls to the missile bays are rendered inoperable (100 damage points inflicted), and the humans escape.

Should the adventurers accomplish their mission, but then be killed or captured, they will have the knowledge that they have sacrificed themselves for the greater glory of the unit.

Variations: The situation can make an exciting two-player situation, with or without a referee, in the manner of Snapshot or Azhanti High Lightning scenarios. Another alternative would be to allow players to control the Aslan side, defending against human raiders. Other situations will, no doubt, present themselves to the fertile imaginations of players and referees.

Striker: The situation on Ildrissar makes for an interesting backdrop to individual Striker battles or a whole campaign fought according to Striker rules. Use the background presented above to generate the basic situation: then add whatever additional wrinkles seem best for an exciting situation. Imagination, creativity, and the strategy of participating players will carry the situation on from there.

Warlord Battle Leader

Battle Leader BL-C1346G2-900000-40009-0 MCr2786.832 3 ktons
batteries bearing A 2 Crew=63
batteries A 2 TL=14
Passengers=20. Low Berths=42. Fuel=1080. EP=180. Agility=4.
Marines=42(low). Two pinnaces. Ten air/rafts.

Tonnage: 3,000 tons (standard). 42,000 cubic meters.

Crew: 14 officers, 49 enlisted personnel.

Performance: Jump-3. 4-G. Power Plant-6. 180 EP. Agility - 4.

Electronics: Two model/7 fib computers.

Hardpoints: Two 50-ton bays. Ten hardpoints.

Armament: Two 50-ton missile bays. Ten triple beam laser turrets in ten batteries.

Defenses: Armored hull (factor-9).

Craft: Two 60-ton pinnaces. Ten air/rafts.

Fuel treatment: Ship is equipped with fuel scoops and on-board fuel purification plant.

Cost: MCr2786.832 standard. MCr2229.4656 in quantity.

Construction Time: 34 months singly; 23 months in quantity.

Comments: Developed as a coordination and control vessel for military operations, the Tleiatre (often translated roughly as "Warlord" or "Leader of Hosts") class of Battle Leaders is often employed as a headquarters vessel for campaigns involving units of Battle Group (battalion) level or higher. Primarily a coordination ship, the Warlord class mounts enough weaponry for most routine encounters, but it is not intended for strictly ship-to-ship actions, and fares poorly against opponents of equal size designed for combat purposes.

The ship is designed to carry headquarters forces to battle, and from there, to coordinate the activities of ground forces and ships of a small squadron. It is equipped with extra sensor gear, communications facilities, and a second computer, which can be used for setting up complex battle simulations or to solve military problems without interfering with ship operations.

As used by the Teahleikhoi regiment, the Battle Leader carried headquarters staff for ad hoc Battle Groups, as well as serving a number of other useful purposes as required. An HQ platoon of forty-two individuals is kept in low berth on board, organized very much like a standard combat platoon (though lacking heavy vehicular fire support). The ten air/rafts carried on board serve to make these headquarters forces fully mobile.

Space is also provided for twenty passengers. A battle group commander and executive officer, a squadron commodore and exec (if the ship is to serve as flagship for an independent force), a variety of staff officers, an owner's representative, and six medical officers serving in the battalion aid station carried on board can all be accommodated in the passenger space on board.

The ship has been used in other functions as well. Heavy armor has made it an excellent choice as a landing craft for troops taken from other ships, though it is only occasionally used in this fashion. The presence of extensive medical facilities and the use of a Medevac pinnace has also tended to make Battle Leaders into mobile Aid Stations. Both of these, and other jobs which have been assigned to these versatile ships, have tended to remain secondary to the prime job of coordination and command control, however.

INTERIOR LAYOUT

The deck plans for the Battle Leader are included on the accompanying set of 22 x 34 inch sheets. A square grid has been overlaid on the ship plans to allow use with GDW's *Snapshot* and *Azhanti High Lighting* games. The scale is the standard *Traveller* 1.5 meter square. Other important symbols and codes are shown on the map key.

COMMAND DECK

The forward portion of this deck is given over to the Maneuver Bridge, from which the ship is controlled. There are eight stations on the Bridge which may be crewed.

1. Captain. All command functions can be monitored and controlled from here.
2. Helm. Occupied by one of the pilots.
3. Navigation. Occupied by one of the pilots.
4. Computer. Occupied by a computer officer as required.
5. Communications. Occupied by a communications officer as required.
6. Gunnery Control. Occupied by the Gunnery Officer in combat situations.
7. Engineering. Occupied by one of the Engineering Officers as required.
8. Squadron Commodore. Occupied by the Squadron Commodore in combat situations or as required.

The Bridge is fully crewed only during combat situations. Normal watch-keeping in Deep Space requires Helm, Navigation, and Computer stations to be manned. In jump, only the latter two need be crewed. Other positions may be occupied, or not, as dictated by the specific situation.

Aft of the computer, a circular walkway overlooks the Pit, enabling observers on this level to monitor activities on the deck below. Two office areas are also present here, used for squadron briefings and planning meetings. They are also used as wardrooms by officers quartered on this deck.

Eight staterooms are set aside for use by ship's officers on this deck. Only two of these, those belonging to the Captain and the Executive Officer, are singles. All others are shared.

The after portion of the command deck is taken up by the ship's two pinnace bays, plus equipment lockers and storage areas. Two triple laser turrets here provide the ship's upper arc of fire, and protection for the pinnaces during close combat.

QUARTERS DECK

The middle deck of the Battle Leader is almost entirely devoted to accommodations. The forward portion of the deck is occupied by the various passengers who are carried on board — members of the regimental command of a particular mercenary unit. The Briefing Room, a large compartment with panoramic windows looking through the bow, is flanked by large single cabins used by the Regimental Commander and his adjutant.

Immediately aft, four staff offices surround the lower level of The Pit. These offices are set up as Battle Simulators; consoles within duplicate the facilities of the Battle Control Center. Windows from these rooms look into the open area of the Pit, where 3D holographic projections can be set up to simulate a

WARLORD BL - C1346G2 - 900000 - 40009 - 0 MCr 2770.56 3000 tons
 batteries bearing A 2 Crew - 63.
 batteries A 2 TL - 14.
 Passengers - 20. Low Berths - 42. Fuel - 1080. E.P. - 180. Agility - 4.
 Marines - 42. Pinnaces - 2. Air Rafts - 10.
 Note: Ship has 2 Model/7 fib computers.

WARLORD Class Battle Leader

WARLORD BL - C1346G2 - 900000 - 40009 - 0 MCr 2770.56 3000 tons
 batteries bearing A 2 Crew - 63.
 batteries A 2 TL - 14.
 Passengers - 20. Low Berths - 42. Fuel - 1080. E.P. - 180. Agility - 4.
 Marines - 42. Pinnaces - 2. Air Rafts - 10.
 Note: Ship has 2 Model/7 fib computers.

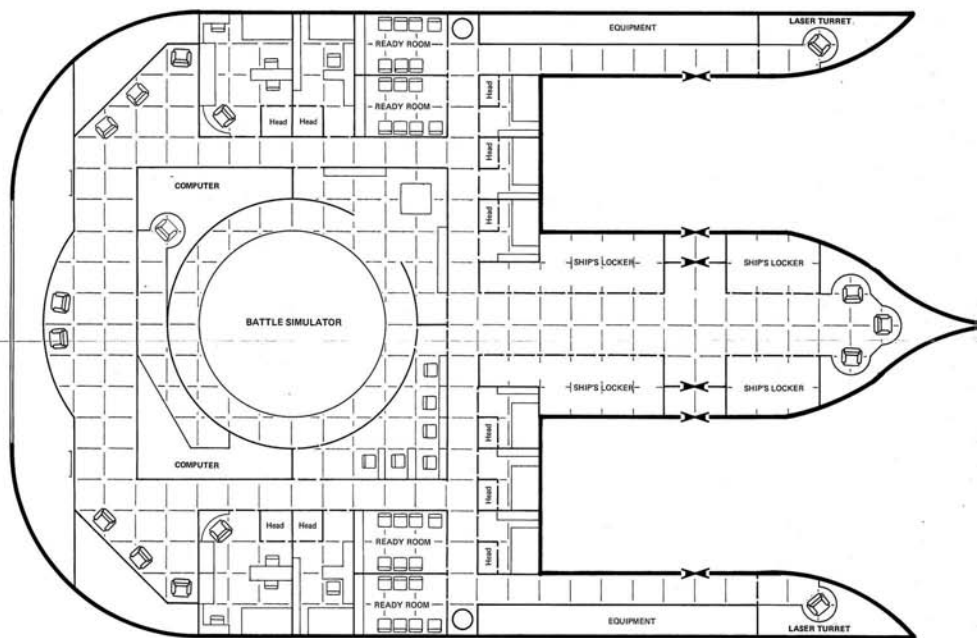

Command Deck

Command Deck Landing Legs

WARLORD Class Battle Leader

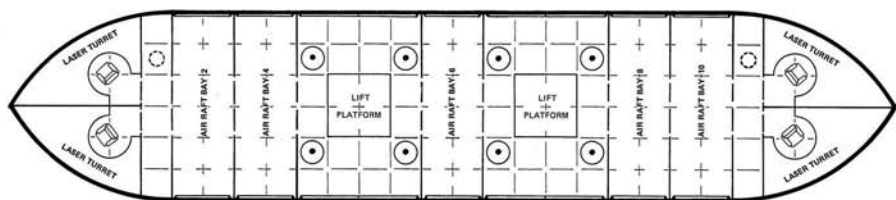

Starboard Landing Leg



Medevac Pinnace

Recon Pinnace

Port Landing Leg

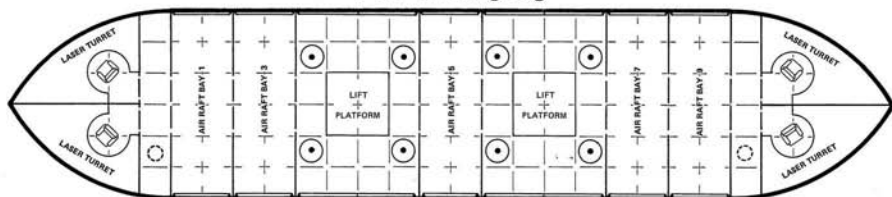

WARLORD BL - C1346G2 - 900000 - 40009 - 0 MCr 2770.56 3000 tons
 batteries bearing A 2 Crew - 63.
 batteries A 2 TL - 14.
 Passengers - 20. Low Berths - 42. Fuel - 1080. E.P. - 180. Agility - 4.
 Marines - 42. Pinnaces - 2. Air Rafts - 10.
 Note: Ship has 2 Model/7 fib computers.

WARLORD Class Battle Leader

WARLORD BL - C1346G2 - 900000 - 40009 - 0 MCr 2770.56 3000 tons
 batteries bearing A 2 Crew - 63.
 batteries A 2 TL - 14.
 Passengers - 20. Low Berths - 42. Fuel - 1080. E.P. - 180. Agility - 4.
 Marines - 42. Pinnaces - 2. Air Rafts - 10.
 Note: Ship has 2 Model/7 fib computers.

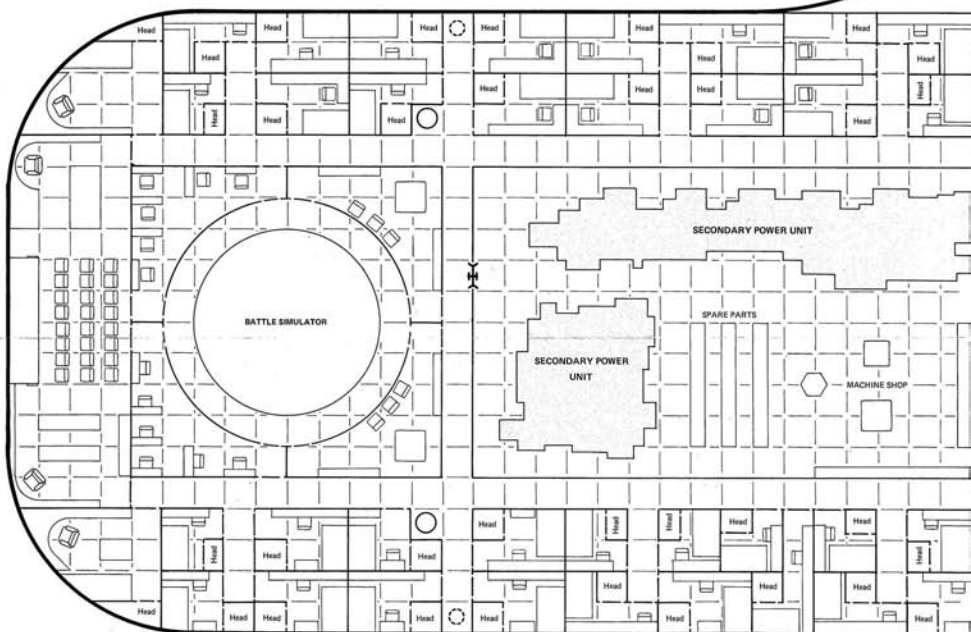

Quarters Deck

Quarters Deck

WARLORD Class Battle Leader

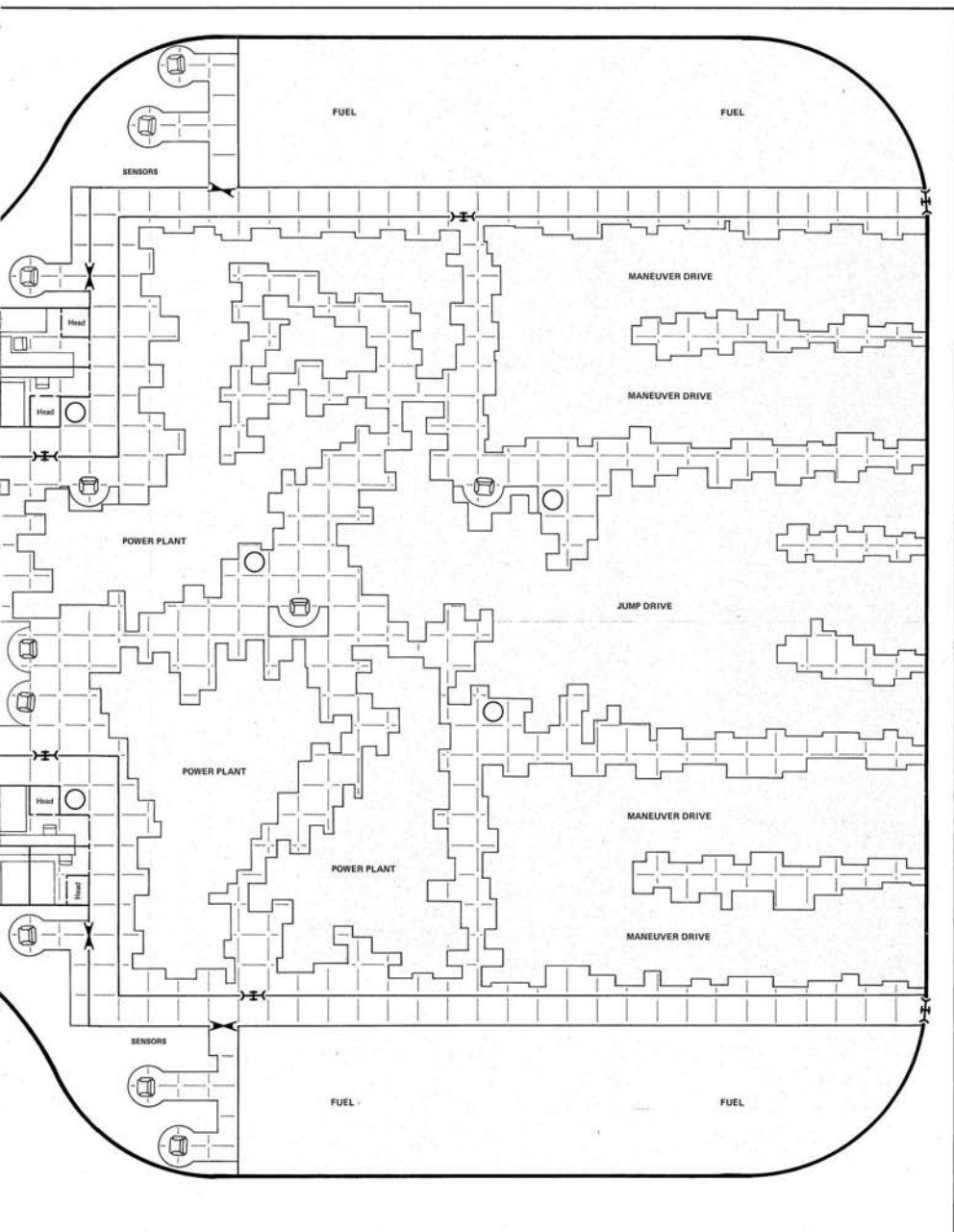

WARLORD BL - C1346G2 - 900000 - 40009 - 0 MCr 2770.56 3000 tons
 batteries bearing A 2 Crew - 63.
 batteries A 2 TL - 14.
 Passengers - 20. Low Berths - 42. Fuel - 1080. E.P. - 180. Agility - 4.
 Marines - 42. Pinnaces - 2. Air Rafts - 10.
 Note: Ship has 2 Model/7 fib computers.

WARLORD Class Battle Leader

WARLORD BL - C1346G2 - 900000 - 40009 - 0 MCr 2770.56 3000 tons
 batteries bearing A 2 Crew - 63.
 batteries A 2 TL - 14.
 Passengers - 20. Low Berths - 42. Fuel - 1080. E.P. - 180. Agility - 4.
 Marines - 42. Pinnaces - 2. Air Rafts - 10.
 Note: Ship has 2 Model/7 fib computers.

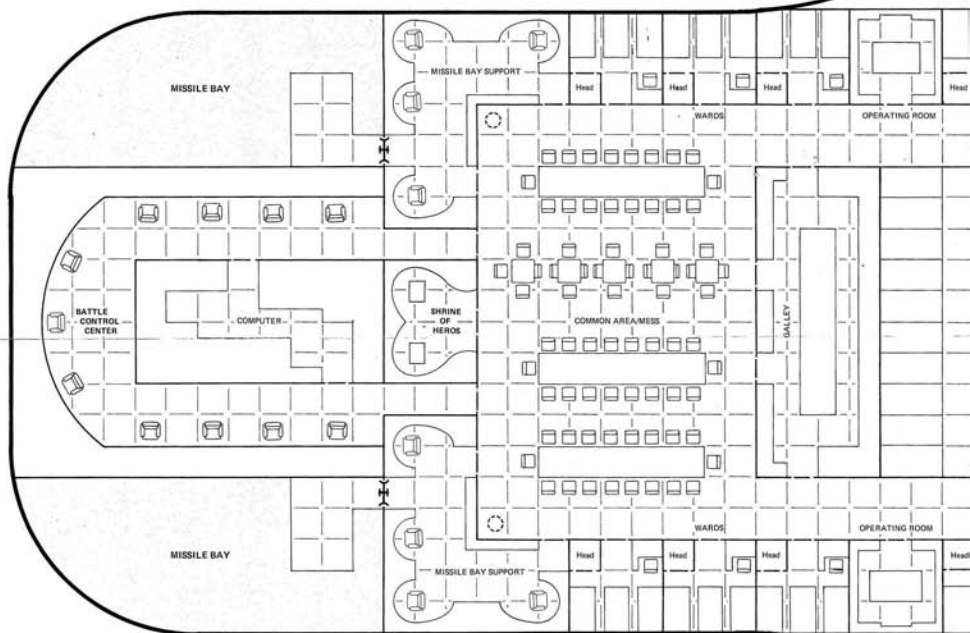

Battle Deck

Battle Deck

WARLORD Class Battle Leader

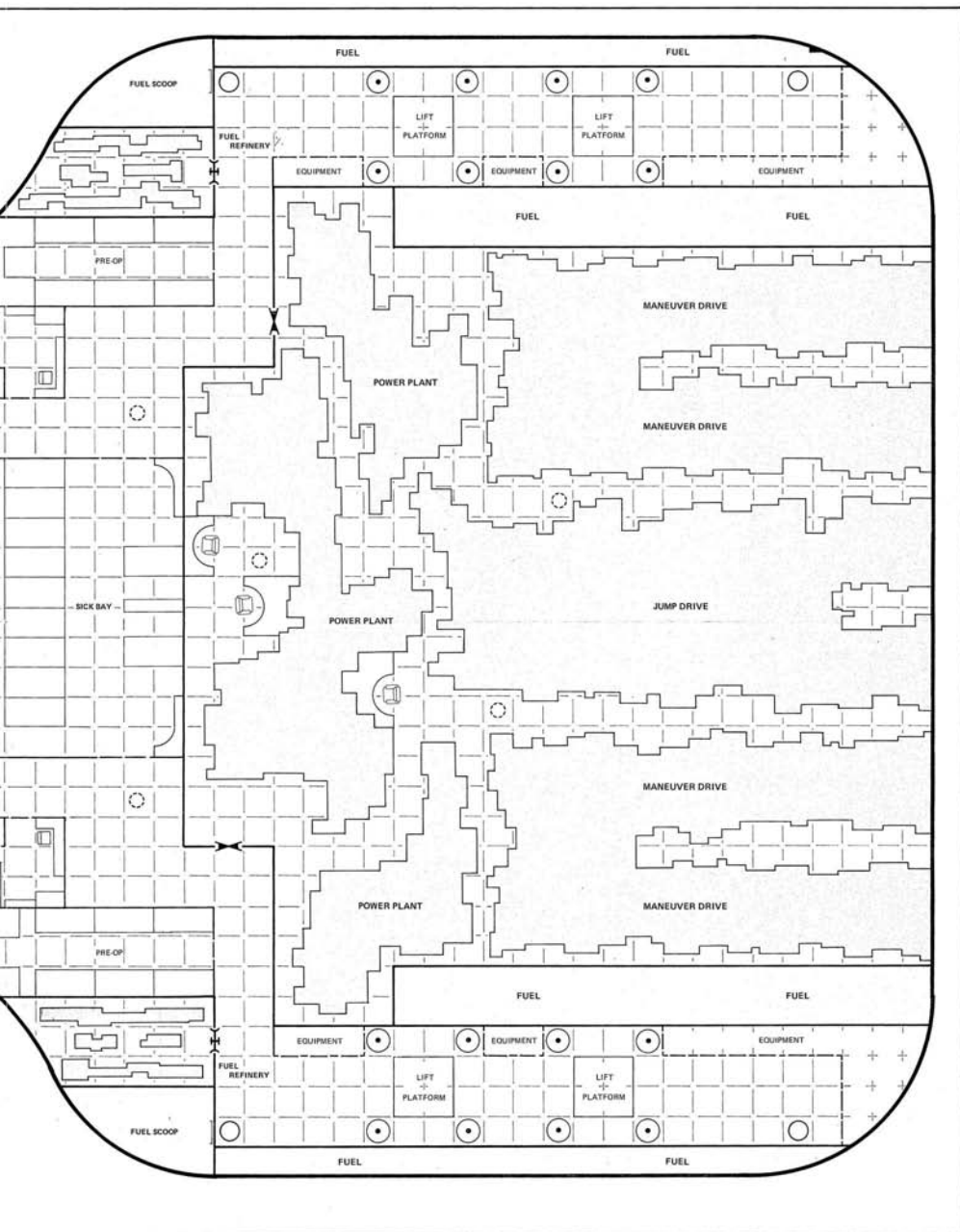

variety of situations. Officers are run through problem-solving sessions and drills here (controlled by the ship's secondary computer). During actual combat situations, the facilities can be meshed with those on the Battle Deck to allow senior regimental staff to review problems and plan operations as needed.

Cabins on either side of this area house a total of eighteen officers attached to the Regiment command and staff. Crew quarters and engineering spaces are aft of this. Twenty double-occupancy cabins, plus a handful of other compartments set aside for storage and office space, run along each side of the deck. Power plant machinery, maneuver drives, and fuel tankage fills most of the remaining space.

BATTLE DECK

The lowest full deck of the Warlord is the most important one in terms of allowing the ship to fulfill its role in combat. It is the Battle Deck, where the mercenary unit is employed in combat.

The forward portion of the deck holds two Missile Bays, plus the fire control centers needed for each. Between these, in the bow of the ship, is the Battle Control Center. This area has consoles for nine individuals; they are crewed in combat by various staff officers (all female), coordinating the activities of a mercenary regiment in the field. Three battalion staff officers, and six company liaison officers, are posted here. The section on page explains more on how the Aslan regiment is organized, and the role taken by these individuals.

A second computer is installed on this deck, just abaft the BCC. It is used to set up battle simulations and drills in space; during combat, it controls the operations of the Battle Control Center to free up computer time for the ship's operations on the main computer. In case of damage, either computer can fill the functions of the other (though one computer doing both ship and field duties will be sharply curtailed in capacity and efficiency).

Aft of these sections is a large common area, surrounded by a number of compartments and cabins. Three cabins house the ship's medical staff. (Other surrounding cabins are used as operating rooms, supply and storage compartments, and two large wards for sorting and prepping incoming casualties. Additional cabin space is used as needed — to house prisoners, extra supplies, or even additional passengers in special situations.

Immediately forward of the common area, and right abaft the computer, is the ship's Shrine of Heroes. This small area is a place of meditation and devotion, set aside in memory of past accomplishments and deeds by Aslan heroes — especially those from the ship itself. Holographic sight-and-sound recordings of individuals and events can be played by those seeking inspiration.

The common area itself is the ship's mess hall, and a galley area services it. Sick Bay is also located on the deck, along with 42 low berths. These low berths hold troops in transit — personnel attached to the headquarters platoon of the regiment. In combat, these troops are rivied and fielded, while the low berths are used by the medical staff for temporary confinement of seriously injured patients. These patients will later be transferred to their regular ships, to free up the low berth space as it is needed.

The aftermost part of the deck is filled by additional engineering space. Fuel scoopes, purification plants, and tankage are located on the deck, as well as heavy machinery for the jump drive, maneuver drive, and ship's power plant.

In some cases where a lightning raid with picked troops is contemplated, the ship will take on soldiers from other vessels in the squadron, mustering them in the Common Area. Equipment lockers on the deck store weaponry and other gear, and stand opposite the elevators leading to the ship's landing legs. Troops may descend through these to leave the ship as a battle begins.

LANDING LEGS

The two lowest levels of the ship, the landing legs, contain two large debarkation areas. These are connected by elevator to the Battle Deck. Ten air/rafts are also stored here. Eight of the ship's laser turrets are present as well, and can lay down heavy fire during landing operations.

CONDITIONS ON BOARD

Standard conditions aboard the Battle Leader are not very different from those found aboard any starship. Internal gravity, climate, lighting and other factors are very close to the human norm.

Controls, consoles, and the like are, of course, labelled in Aslan; humans are unlikely to be able to puzzle out any specific controls unless they understand the language (the referee should designate this in advance of any encounter).



Medevac Pinnace

Recon Pinnace

RECON PINNACE

KS - 0606A21-0000-0-30000-0 MCr57.7 60 tons
Crew=2. Passengers=20. Cargo=6. Fuel=6. EP=6. Agility=6. TL=14.

A 60-ton small craft used for scouting and close support purposes, the recon pinnace can function as a transport for up to 20 troops. Dual lasers can be used for everything from target designation to aerial fire support missions.

MEDEVAC PINNACE

KQ - 0606811-030000-20000-0 MCr43.65 60 tons
Crew=2. Passengers=7. Low Berth=30. Casualty Deck=2.4. Fuel=5.
EP=48. Agility=6. TL=14.

A variant of the recon pinnace, this model is equipped with space for passengers (including a small medical team), low berths for recovered casualties, and a Casualty Deck area devoted to treatment of individuals too seriously wounded to await transportation back to the Battle Leader. The Medevac pinnace is armed, carrying a single fixed-mount laser and a sandcaster for defense.



COMPANY ORGANIZATION

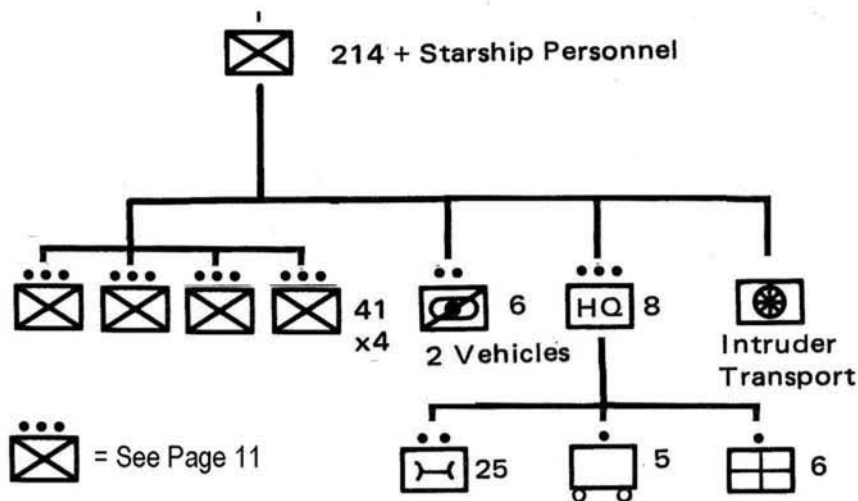

1 Company

Platoon

Section

Squad

Infantry

Fire Support

Headquarters

Transport (Starship)

First Aid

Logistics

Repair

The heart of the regiment is composed of nine companies, each designed to function equally well as independent entities, or melded together into a force of Battle Group or regimental size. Each company numbers 214 individuals, organized into four combat platoons plus support personnel.

Company Command: The company is headed up by a Company Commander (rank O3), a male Aslan who directs the unit in combat. He is assisted by a female staff (generally an Exec of rank O3 and two assistants of lower rank). The female officers run the unit at all times except during combat, while the commander takes charge during battle situations.

The company commander is backed up in the field by a senior NCO, plus two other soldiers (driver and radioman). A driver is also assigned to the female staff officers. Two of the six air/rafts on board the Intruder Transport are assigned to the headquarters personnel.

In combat, the male commander and his team will be found in the forefront of the fighting; the female staff is employed at a headquarters in the rear. The Intruder Transport carries no troops at all during these times: it fills the role of heavy fire support, called in as needed by the HQ staff to break a stubborn position.

RESCUE MISSION

Background: The campaigns on Ildrissar (Drexilthar 0706 C995836-7) was notable for the sudden changes in fortune for both sides, with kept the issue of the war long in doubt. The Aslan mercenary forces hired to support the troops of the Carrillian Assembly were powerful; they swept aside the feeble resistance of rebel defenders with little difficulty time and time again.

The best hop of the rebel army had been the defensive position of Deathgorge Pass, a high mountain road easily held by ground forces. Although faced by superior numbers, the rebels had the defensive advantage at the pass, with fire support to prevent breakthroughs by grav vehicles and well-placed infantry to guard against the Carrillian regulars. But the Assembly, spearheaded by Aslan forces, stormed the defenses and overcame the rebels in a matter of days, breaking through into the settled plains beyond like a torrent.

As they advanced, the attackers cut the line of retreat for Ildrissar's main field army. Trapped in the wilderness, far from supply and hemmed in by mounting pressures from several directions, most of the main body was forced to surrender. Among the prisoners taken was General Willairn Tallas, Chief of Staff of the rebel army. A key spokesman of the rebel cause, and the originator of the planet's defensive plans, Tallas was an important prize. Without him, Ildrissar's cause would soon sounder. With him, the Assembly could easily extract enough information to render impotent all rebel operations and plans.

It was an Aslan unit which accepted the General's surrender — fortunately for Tallas, since the Assembly would probably have executed him as an agitator. The mercenaries, however, conveyed Tallas to the Battle Leader Hrahafuh, the vessel coordinating the battle group's operations from orbit. Confined on board, Tallas was the focus of intensive interrogations by the Aslan staff.

Despite the seeming disaster of Deathgorge Pass and its aftermath, however, not everything was black for the rebel cause. Their own mercenary hirelings, the Caledon Highlanders, helped even the odds somewhat. A patrol commanded by one Lieutenant Hamilton captured, intact and without time for warnings to be issued, a pinnacle belonging to the Assembly forces as it attempted to land a small commando team deep behind rebel lines. Hamilton showed great initiative in keeping the lid on the situation; no word of the craft's capture leaked out. It also attracted the attention of Hamilton's superiors, who formulated a hasty plan that offered the only chance of saving General Tallas.

Hamilton and a portion of his platoon — 22 men in all — were ordered to use the captured pinnacle to reach and board the Battle Leader in orbit. There they were to find the General, liberate him, and try to get him back to the surface of Ildrissar alive. It was a risky venture, relying on speed, surprise and no small amount of luck. But, if it paid off, the impact on rebel morale would far outweigh the actual importance of the victory itself. And, if it failed, things would be no worse— except for Hamilton and his platoon.

Thanks to an ex-Marine in the platoon with skill in handling small craft, Hamilton's Trojan Horse was able to make orbit and approach the Battle Leader. Captured Assembly uniforms helped the daring band of humans lull the Aslan into a false sense of security. Granted clearance from a bored Bridge crew, the intruders docked.

Now Hamilton and his men must penetrate to the heart of the enemy defenses, and then escape again. If they fail, it will cost them their lives, and the campaign on Ildrissar as well . . .

REFEREE'S NOTES

The rating Party: Adventurers in the human force should be drawn from Army or Marine backgrounds; use of *Traveller Book 4, Mercenary*, is strongly encouraged both for character creation and for weaponry and equipment available. The team numbers twenty-two men, with the referee controlling NPC actions as required. One player-character should be Lt. Hamilton, the leader of the force. Stats for Hamilton are:

James Hamilton (Army 1st Lieutenant) 9B8AA9 Age 30 3 terms (elite)
Tactics-3, Leader-3, Recon-2, Combat Rifle-2, Pistol-2, Grav Vehicle-1,
Demolitions-1

If using *Striker*, members of Hamilton's force should be considered Picked Troops (Hamilton himself is elite, with a morale of 13). The unit may be organized as desired by the players or as designated at the start of the situation by the referee. Equipment available should include combat armor, ACRs, and such other gear as the players may choose (subject to referee approval).

One character in the party should be designated as the character with Ship's Boat skill; he will be essential to the escape of the party. Of course, in generating characters more than one small craft pilot may appear, lessening the danger of losing this key individual.

Aboard the Hrahafuh: The referee should set up the Aslan crew aboard the Hrahafuh secretly prior to the start of the scenario. Crew should be set up roughly referee should deploy the Aslan defenders in a reasonable fashion. They are not expecting an attack; many will not even be armed. The nature of armaments available should be determined to balance the scenario most effectively.

Entry: Raiders begin by attacking out of one of the two pinnace bays, where they have docked their vessel. From this point on, it is up to the party's decisions to determine whether or not they can locate the General, free him, and escape. While doing this, some troops should be left behind to guard the ship (lest their escape be cut off). Finally, some team members may want to consider taking some of the ship's weaponry out of action, to help them in escaping later on. This can be done according to the rules on damaging consoles given in the adventure in the Intruder Transport booklet.

Combat: Rules from *Snapshot* or *Azhanti High Lightning* should be used to resolve combat. The referee may also choose to adapt the miniatures rules presented in *Striker*. The counters provided in this package are sufficient to represent the raiding party (substitute weapons and armor appropriate to the scenario for ratings given on these). **Martian Metals** *Traveller* miniatures may be substituted for counters, if desired.

Aslan Reactions: Aslan morale is covered in *Striker* and in the information presented in these two booklets. If a female staff officer is confronted with a combat situation in this scenario, she will fight, but morale and initiative of such officers will tend to be lower than is normal for fighting males.

Escape: Should the human party rescue the General and win free to the pinnace, it will be necessary to escape from under the guns of the Battle Leader, as well. The situation is ideally resolved using starship combat rules from Book 2, Book 5, or Mayday (or combining such rules in some fashion). If the human force has rendered any of the Battle Leader's guns inoperable, this damage should be

BOOK 2

Aslan Mercenary Ships



INTRODUCTION

This booklet is designed to give *Traveller* players and referees a grounding in the organization and operation of mercenary units which might be encountered on board the Aslan Mercenary Ships described elsewhere in this package. In addition, it provides further information on the Aslan themselves, one of the six Major Races known to the Third Imperium.

The booklet leads off with a recap of material already provided elsewhere on the race, plus some new additions which fill in previously undisclosed facts on the attitudes and behaviour of the Aslan, especially as relates to warfare and mercenary activities. The composition and organization of a particular Aslan mercenary unit is also discussed at some length, providing an example of a typical force that might be encountered. Naturally, though, there is great variance from one unit to another (probably even more than between one human unit and another, given the fragmented nature of Aslan society). The information provided should, however, assist in creating forces to meet in *Traveller* or *Striker* situations where Aslan encounters are called for.

A complete unit organization is provided for a typical platoon from the regiment. This is given in terms of *Striker* rules. It can be used in conjunction with *Striker* miniatures (a set of Aslan figures are available from **Martian Metals**). In addition, counters provided with this package include a set of troops keyed in to this platoon organization. This can be useful if counters are to be substituted for regular miniatures in a *Striker* situation, or when used in conjunction with the deck plans in this package and rules from *Snapshot* or *Azhanti High Lightning*.

Referees are advised that the material presented in this booklet is, on the whole, intended as a sourcebook for *Traveller* information. Descriptions of unit organizations, equipment, and the like are not meant to be taken as gospel; they are intended as guidelines only, from which adventure situations and encounters suitable to a specific game or campaign can be tailored at need.

THE ASLAN AT WAR

Fiercely competitive to a point far beyond any human understanding, Aslan clans vie with one another over land, resources, and position within the Hierate almost constantly. Though they present a greater unity of purpose as a race than do the fragmented Vargr states, the nature of Aslan competitiveness makes war virtually a full-time occupation in almost any area where Aslan clans dwell. Though in some ways this has weakened the Hierate, turmoil and strife have proven useful. Centuries of warfare on various levels have kept the Aslan fighting spirit strong, and made the individual Aslan warrior the fierce fighter that he is today.

Warfare between Aslan clans, though intense, is also limited and controlled by the force of tradition. The nature and scope of a war is usually set in advance — including weapons to be allowed, numbers of troops to take part, area of the fighting, tech level of equipment permitted, and many other factors. These restrictions are enforced, first, by the innate sense of honor which predominates in Aslan society, and, secondly, by members of neutral clans who are called in to inspect and "referee" such conflicts. To be selected as a refereeing clan in such a dispute is a great honor; when chosen, referees are scrupulously fair and honest under any and all conditions (even if one or both participants are particularly friendly or hostile to the referees). Bribery, of course, is never a factor in such supervised wars; even if the participants had so little honor as to propose such a thing, no refereeing clan would ever consider accepting a bribe. This is particularly true when it is remembered that the actual referees are males with vast combat experience, who would never understand the concept of ignoring the dictates of honor in exchange for mere money.

Aslan wars are highly formal, totally bound by these rigid rules and customs. The concept of an interclan war is not strictly confined to the settlement for disputes on a battlefield, though this is, indeed, a popular recourse. There are other modes of "warfare", though, that include wars of assassins (in which rules are set down to attempt to overcome a rival clan through attacks on clan leaders) and many other interesting variations. Some interclan wars are even bloodless; a process of "counting coup" is substituted for actual killing of opponents in these situations. There are Aslan mercenaries versed in many different modes of war, but, for the purposes of this booklet, the strictly military aspects of Aslan mercenary units and operations will be the center of attention.

When fighting outside opponents, the traditional limitations of the interclan dispute are, of course, ignored. The Aslan do not observe the same niceties in these conflicts. But, though they certainly fight to win, a certain amount of chivalry and honor do spill over into their conduct of such conflicts. The Aslan tend to prefer confrontations in which they can kill their opponents face-to-face or, at the least, through their individual, personal skill and expertise. War, for the Aslan, has remained a far more personal profession than it has for other technologically sophisticated races.

Contingents of Aslan often hire out as mercenaries. Organized by females who see war as just another way to turn a profit, the units are usually composed of clanmates and Ihatei looking for a stake of land, or for personal honor and glory. They are hired out to assist in interclan warfare, in support of Aslan corporations, or, occasionally, by one or another of the 29 when forces are required for warfare beyond the borders of the Hierate. Mercenaries are often needed to conduct these

"foreign wars"; the Hierate has nothing like a standing army, or even concerted government planning or action.

Aslan mercenaries are also popular outside the Heirate. Units hired by foreign governments are directed by agents of the employer, enjoying the same status as the unit's owner (or her representative). This can lead to tension when foreigners actually attempt to direct the activities of the unit in person, as friction between the employer and the owner over unit operations can frequently develop. Another problem arises when the employer fails to understand Aslan unit procedures. A common mistake is for a non-Aslan to attempt to interfere in unit operation, something which the owner does only on very rare occasions.

To avoid this kind of friction, the Aslan prefer it if the employer's people do their work from a separate ship or planetary base. A female staff officer can be assigned to the employer for liaison purposes. In this case, many of the problems that can arise from working with non-Aslan can be, if not avoided, at least lessened.

It is, of course, extremely rare to find a non-Aslan leading, or even fighting beside, Aslan troops on the field of battle. Differences in physiology and psychology make such a situation virtually unthinkable.

TEAHLEIKHOI

Organized and operated as a regiment based in the U htaa subsector of Reavers' Deep, the Teahleikhoi regiment (loosely translatable as "Soldiers of the Falling Night" or "Knights of the Setting Sun") is fairly typical of mercenary units that are found in the Hierate. The corporation controlling the unit was organized some 150 years ago by an unmarried female of the Iyhlua clan, and has maintained continuity through a series of handpicked successors to this day. The current owner, Iyhli, is a distant relative of the founder. Like all of the corporation's senior executives, she will hold her post until she dies or marries; at that time, her chosen successor will take charge of the business.

The regiment proper is set up to handle a variety of situations and circumstances, from formal clan wars within the Hierate to operations without rules outside the Aslan sphere of influence. Ships supplied by Larleaftea Hryawaorwya, the prominent shipbuilding firm, are essential to the unit's operations, giving the regiment interstellar mobility, and control and support at the scene of battle.

The regiment can mount operations of any size that may be required, from actions involving a single company up to the commitment of the entire regiment. There are thirteen ships available to the unit — nine Intruder Transports for company-level transportation, three Battle Leaders for command and control purposes, and a large regimental command ship of 5,000 tons equipped to coordinate large-scale operations. This last ship can carry a small fighter squadron, and transports various other support units as required when the regiment as a whole is committed in combat.

In the discussions that follow, this regiment will be examined in greater detail. It is typical of any regiment-sized mercenary forces employed by the Aslan, though there are many variations from one unit to the next. Even the composition of the Teahleikhoi regiment itself has varied in the past, as it has adapted to a variety of changing circumstances. Through it all, though, one essential fact has remained unchanged. The regiment is still Teahleikhoi, with history, traditions, and honor unchanged over a century and a half of warfare in and out of the Hierate. That fact is a proud tradition for the soldiers of the regiment to bear.

TEAHLEIKHOI REGIMENTAL ORGANIZATION

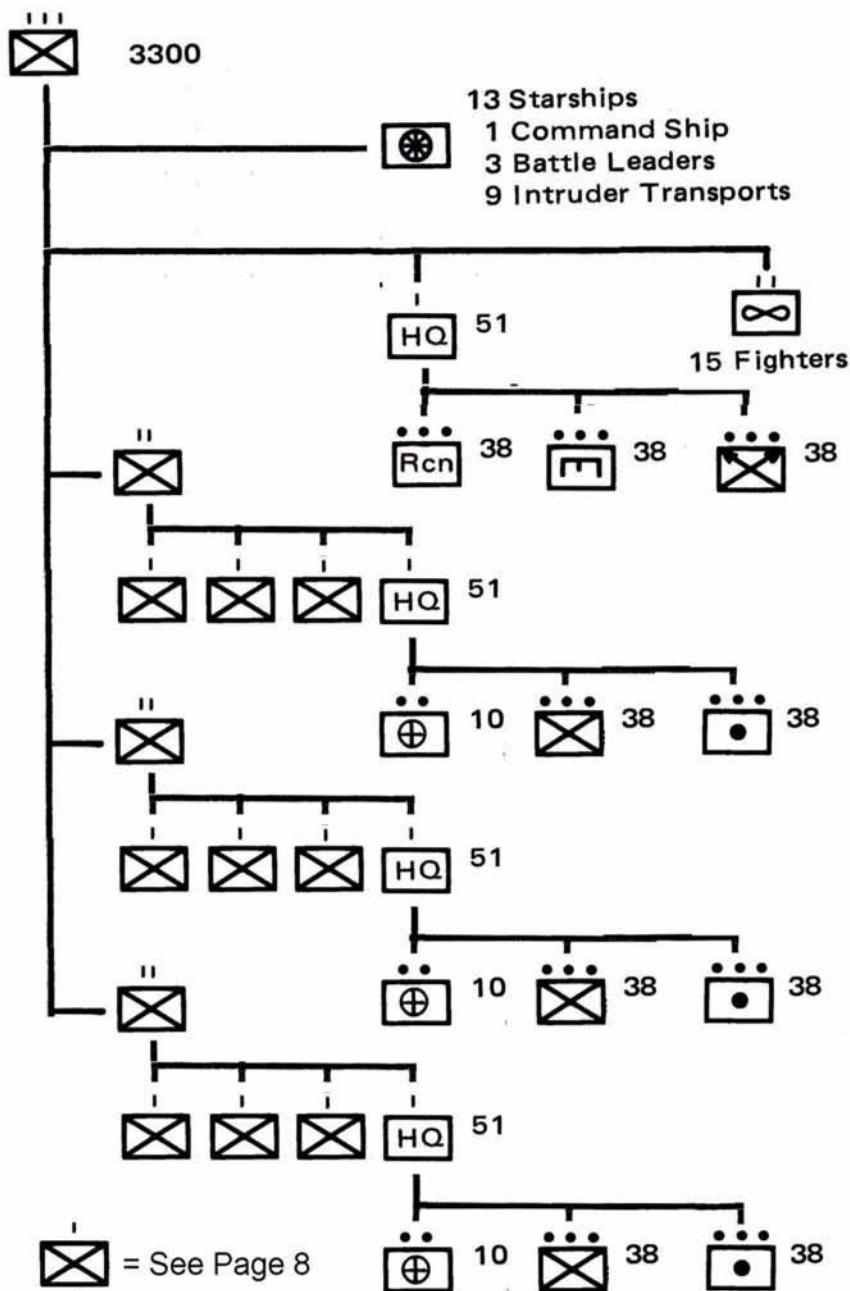

The regiment is responsible to the owner and her assistants. She normally travels with regimental headquarters (along with a small retinue); when the full regiment is not employed, the owner appoints agents to travel with and supervise each smaller unit which is being employed independently. The owner or her agent, by and large, do not interfere in the workings of the unit being accompanied. However, they provide the ultimate authority in all business decisions, and sometimes will intervene in operations when they feel that the owner's best interests are threatened by a proposed action. It is the owner and her staff who deal with negotiating contracts and tickets, and otherwise supervising business and financial matters for the mercenary unit.

Regimental headquarters, including not only the senior officers of the unit but also the fighter squadron, regimental artillery, and other supporting units, are carried on board a 5,000 ton regimental transport. This ship is rarely encountered; when it is employed, it remains in a position of relative safety to coordinate regimental activities. Since it is so infrequently met, further details of this ship are not important in this discussion. If referees are interested in the ship, they should feel free to develop it on their own, using the rules from High Guard.

The regiment is commanded by a Colonel, an Aslan male of high social level. The colonel leads the unit in combat, making tactical decisions and fighting alongside his troops on the field. He is backed up by a large staff of female officers, who handle various aspects of supply, intelligence, administration, strategic and operational planning, and other work for which the males are temperamentally unsuited. Between battles, it is the female Regimental Executive Officer who actually runs the unit on a day-to-day basis. She has considerable authority, practically equal to that exercised by the colonel himself.

Regimental headquarters also includes a Fleet Commodore (male) and Fleet Exec (female), officers with naval experience who coordinate the movements of the starships attached to the unit. The Fleet Commodore is subordinate to the Colonel in rank, but may appeal to the Owner for release from ground control on certain rare occasions -- when, in his view, the ships are threatened if they remain under orders from ground-based personnel. His Exec is in charge of all non-combat squadron procedures and operations.

The regiment is employed as a whole only on infrequent missions. In most cases, a Battle Group (two or more companies under a Group Commander on board one of the unit's Battle Leaders), or even a single Intruder Transport carrying a reinforced company, will operate independently. When this is done, the owner appoints a representative to oversee the detachments activities. This individual is an addition to the personnel normally serving on board the ship; her presence may displace the ship's officers in order to provide extra cabin space. When this happens, it usually causes the ship's Exec to share quarters with one of the other female officers aboard.

INDEPENDENT OPERATIONS

For the most part, the regiment tends to conduct several different operations at the same time, hiring out smaller units for a variety of individual missions. This is done largely because of the need for smaller units; in addition, separate employment of several units can, generally, bring in more money than the single regiment does. Because of this need for self-containment, each unit of the regiment is organized and equipped for independent operations. Provisions are also made for coordination of forces larger than a single company, but smaller than a regiment.

Individual companies can be sent on independent missions, with or without the addition of one of the regiment's specialty platoons. Each company is wholly contained aboard an Intruder Transport type starship. An owner's agent will join the vessel; ground control is exercised by the company commander while the ship's captain is in command in space. Single company missions are perhaps the most frequently required of all the regiment's operations.

When a company operates on its own, and a specialty platoon is also present, this unit will almost always be a combat or recon platoon. The extra unit will be directly integrated into the company.

Some tickets require more than this, but still do not need the presence of the entire regiment. In such cases, a Battle Group is formed. A Battle Group is an ad hoc battalion created for a specific mission or task. Two to five companies are generally assigned to a Battle Group (the usual number is three). Special platoons carried on each of the Intruder Transports in the force are assigned according to need. One mission might require engineers, while another might be better off with artillery or recon units instead.

The Battle Group is coordinated from the decks of a Battle Leader type starship. The ship carries the unit headquarters (an HQ platoon, command and staff officers, a battalion aid station, and the faculties of the ship itself). With an array of sensor gear, communications equipment, and other electronics, the Battle Leader makes an excellent control and coordination vessel in the absence of the regimental command ship.

A male officer of rank O4 or O5, drawn from a pool of such fighting officers with regimental headquarters, commands the Battle Group. A female Exec assists him. Other officers are mostly females, in charge of all manner of staff duties and liaison operations. The commander, of course, fights on the ground with the troops, leaving it to the staff to actually coordinate the unit in battle.

Subordinate to the Group Commander is the Squadron Commodore, who commands the ships of the Battle Group. He is also assisted by an Exec. As with the Fleet Commodore aboard the regimental command ship, the Squadron Commodore can ask for release from the ground force's control, if circumstances warrant it and the owner's representative agrees. Aside from this and other special cases, the owner's agent rarely becomes involved in the unit's active operations.

Independent companies or Battle Groups can operate on their own for extended lengths of time, though it is often necessary for them to rely on their employers for logistical support in a prolonged campaign. Battle Groups are strictly temporary formations, having no permanent existence in the unit's command structure: they may, however, be formed during the course of a full regimental operation as well as being employed on their own. In all cases, flexibility is the keynote, for the unit must be able to perform under a variety of circumstances, and meet all with equal ease.



COMPANY ORGANIZATION

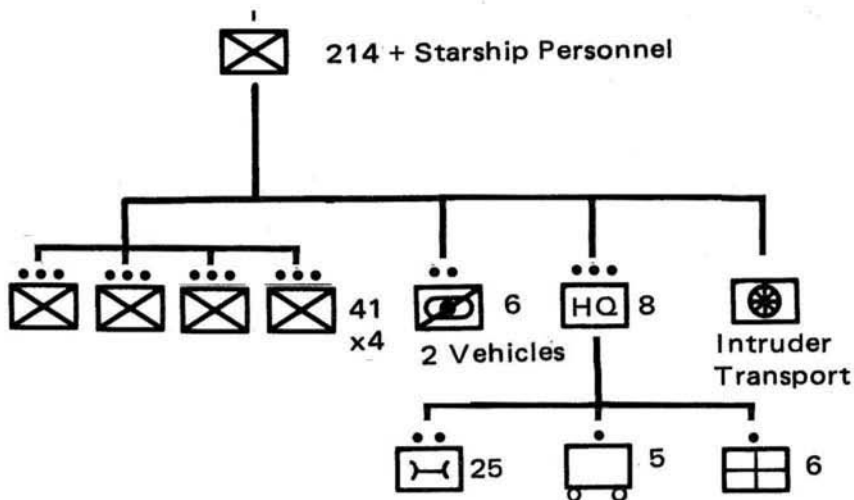

Company



Platoon

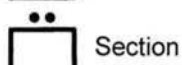

Section

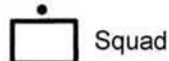

Squad



Infantry



Fire Support



Headquarters



Transport (Starship)



First Aid



Logistics



Repair

The heart of the regiment is composed of nine companies, each designed to function equally well as independent entities, or melded together into a force of Battle Group or regimental size. Each company numbers 214 individuals, organized into four combat platoons plus support personnel.

Company Command: The company is headed up by a Company Commander (rank O3), a male Aslan who directs the unit in combat. He is assisted by a female staff (generally an Exec of rank O3 and two assistants of lower rank). The female officers run the unit at all times except during combat, while the commander takes charge during battle situations.

The company commander is backed up in the field by a senior NCO, plus two other soldiers (driver and radioman). A driver is also assigned to the female staff officers. Two of the six air/rafts on board the Intruder Transport are assigned to the headquarters personnel.

In combat, the male commander and his team will be found in the forefront of the fighting; the female staff is employed at a headquarters in the rear. The Intruder Transport carries no troops at all during these times: it fills the role of heavy fire support, called in as needed by the HQ staff to break a stubborn position.

Company Casualty Station: Six medics are required to run the Company Casualty Clearing station, which is set up on the ground in the rear of the company. Three drivers, each controlling an air/raft from the Intruder Transport, are also part of this group. They are used to help retrieve casualties from the front. The company casualty clearing station provides good front-line medical support. In combined operations, the battalion aid station carried on board each Battle Leader effectively backs up the company-level medical unit; use of the Battle Leader's Medevac pinnace enables serious casualties to be transported from the ground to the orbiting Battle Leader for treatment.

Logistics: Two individuals from the company are required as logistics personnel and cooks. An air/raft is available to them; in addition, launches from the Intruder Transport (or sometimes, if space is available, an extra transport vehicle) are used to ferry supplies from the ship. Crewmen assigned to the launches are part of the ship's crew, not the logistics staff. Troopers assigned to logistics are generally females or low-caste males; the role is never filled by combat soldiers.

In the field, Aslan soldiers eat prepared rations, getting hot meals only on occasion from the ship. They do not, however, suffer adverse morale effects for the lack of such meals, as per Striker rules.

Mechanics: Aslan vehicles and equipment must be maintained by specialists, females and low-caste males with a technical background. Fighting troops are incapable of performing maintenance chores — they lack the knowledge, even if they had the temperament — to permit them to take part in such tasks. Thus the need for mechanics is even larger in Aslan units than in those of human armies, since there is no possibility of preventive maintenance by those who operate the equipment. A total of 25 individuals are required in this company organization.

A maintenance van with an installed workshop is often available to the unit; if it is not, the workshop is set up on the ground, ferried down by one of the launches and set up in a convenient rear-area position.

Company Fire Support: Two of the eight vehicles carried on board the Intruder Transport are indirect fire support vehicles. These vehicles are normally given a crew of three (commander, driver, and gunner), and mount MRLs as their primary indirect fire weapon. Exact designs will vary according to the unit's employment and requirements. These basic notes should serve, however, as a guideline.

Combat Platoons: Four platoons make up the front-line fighting force of the company. These are discussed in greater detail further on in this booklet. Each consists of forty-one individuals and one vehicle.

The Intruder Transport: The Intruder Transport vessel described in the Aslan Mercenary Ships booklet is used as the company's transportation between worlds. It also provides fire support as needed in combat.

The ship carries a single company. Eight vehicle bays are provided, four for the vehicles used for platoon fire support, two carrying indirect fire vehicles, and two others holding vehicles are required by the mission and special needs of the unit. This usually means that one vehicle bay is used to carry a vehicle required by a specialty platoon (if present on board), while the other vehicle may be used by the medical unit, the logistics team or to transport a mechanical workshop. There are many different possibilities: the exact types of vehicles carried on board will differ from one to another.

In combat, the Intruder Transport is commanded by its captain, but this officer is subordinate to any squadron or fleet commodores present in the system. In the absence of these individuals, he takes orders from the company commander.

When the ship is functioning independently, a representative of the owner will be assigned to oversee unit operations. She remains on board, and for the most part does not interfere in the operations of the ship or the mercenary unit.

THE PLATOON

The basic building block of the fighting force is the Combat Platoon, a unit containing forty-one individuals mixing light infantry and low-level vehicular fire support. Four combat platoons form the fighting core of each company. Similar units are also maintained as special units, outside the bounds of regular company organization, and are assigned as needed to strengthen various units in the field.

The platoon is led by an officer of rank 01 or 02; he is assisted by a platoon NCO. For purposes of Striker, each is elite, and mounted separately. The remaining 39 soldiers are divided into four infantry squads and one vehicle squad.

The support vehicle has a crew of three (commander, driver, and one gunner). It mounts a fusion-Y gun for anti-tank work, with a VRF Gauss gun for anti-personnel and point defense combat. This vehicle is employed in the field in support of the platoon. Exact vehicle designs vary according to circumstances.

A squad contains a squad leader (elite, mounted separately,) plus two fire teams of four men each.

Troops in the platoon are generally armed with gauss rifles, and carry RAM grenades as well. Each squad (except for the vehicle squad) has one PGMP-14 for support fire. Each section also has one medic assigned; this individual is a lower-class male who is not armed. Some details in the organization will vary from unit to unit; equipment is often varied according to special restrictions for inter-clan wars. This, however, is a good basic picture of the way an individual platoon is set up.



the Combat Platoon

Platoon Leaders; elite; gauss pistol; morale 15, high initiative
Platoon NCO; elite gauss rifle; morale 15, high initiative

1st Squad Morale 15, high initiative
Squad NCO; elite; gauss rifle

A Fire Team;

morale 9; average initiative
Veteran; gauss rifle
Regular; gauss rifle
Regular; PGMP-14
Regular; gauss rifle

B Fire Team;

morale 9; average initiative
Veteran; gauss rifle
Regular; gauss rifle
Regular; PGMP-14
Recruit; gauss rifle

2nd Squad Moral 12, average initiative
Squad NCO; veteran; gauss rifle

C Fire Team;

morale 9; average initiative
Veteran; gauss rifle
Regular; gauss rifle
Regular; PGMP-14
Recruit; gauss rifle

D Fire Team;

morale 9; average initiative
Veteran; gauss rifle
Regular; gauss rifle
Recruit; gauss rifle
Recruit; medic

3rd Squad Morale 12, average initiative
Squad NCO; veteran; gauss rifle

E Fire Team;

morale 9, average initiative
Veteran; gauss rifle
Regular; gauss rifle
Regular; PGMP-14
Recruit; gauss rifle

F Fire Team;

morale 8, average initiative
Veteran; gauss rifle
Regular; gauss rifle
Regular; gauss rifle
Recruit; gauss rifle

4th Squad Morale 12, average initiative
Squad NCO; veteran; gauss rifle

G Fire Team;

morale 9, average initiative
Regular; gauss rifle
Regular; PGMP-14
Recruit; gauss rifle

H Fire Team;

morale 7, low initiative
Regular; gauss rifle
Regular; gauss rifle
Recruit; gauss rifle
Recruit; medic

Vehicle Squad Morale 15, high initiative
Vehicle Commander; elite
Drivers; Veteran
Gunners; Regular

A complete unit organization is provided for a typical platoon from the regiment. This is given in terms of *Striker* rules. It can be used in conjunction with *Striker* miniatures (a set of Aslan figures are available from **Martian Metals**). In addition, counters provided with this package include a set of troops keyed in to this platoon organization. This can be useful if counters are to be substituted for regular miniatures in a *Striker* situation, or when used in conjunction with the deck plans in this package and rules from *Snapshot* or *Azhanti High Lightning*.

Aslan Mercenary Ships Counter Sheet 1

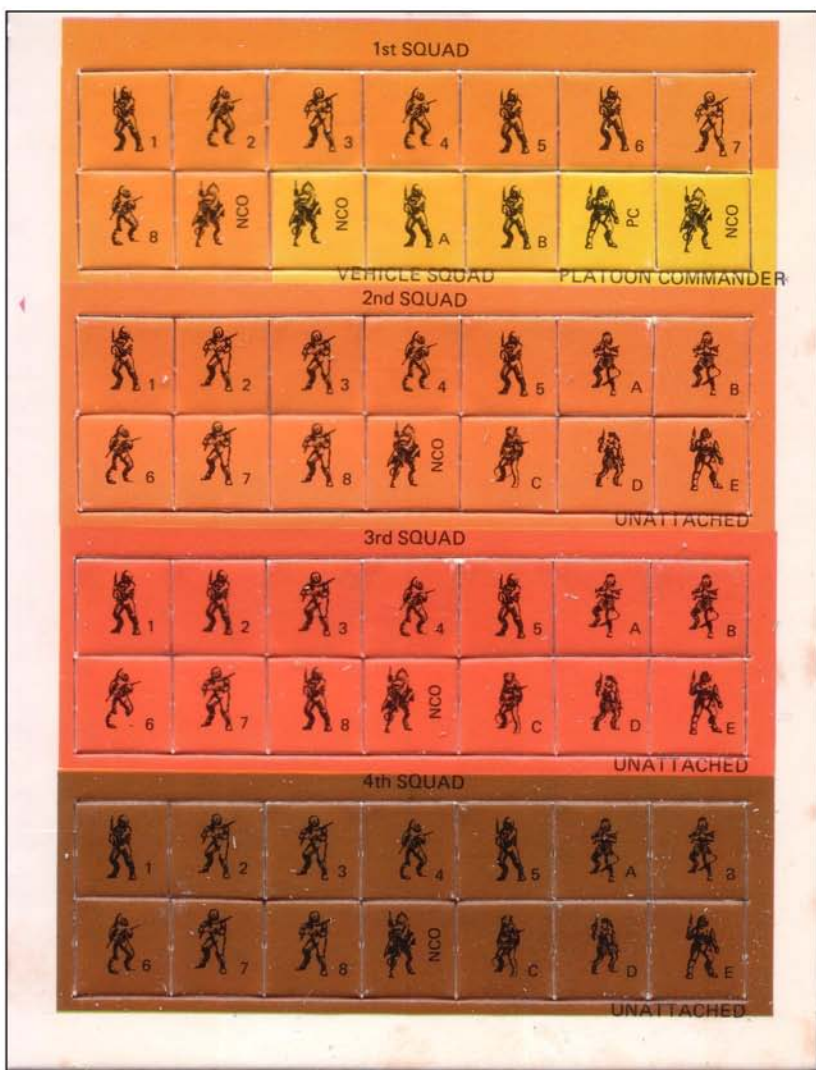

A complete unit organization is provided for a typical platoon from the regiment. This is given in terms of *Striker* rules. It can be used in conjunction with *Striker* miniatures (a set of Aslan figures are available from **Martian Metals**). In addition, counters provided with this package include a set of troops keyed in to this platoon organization. This can be useful if counters are to be substituted for regular miniatures in a *Striker* situation, or when used in conjunction with the deck plans in this package and rules from *Snapshot* or *Azhanti High Lightning*.

Aslan Mercenary Ships Counter Sheet 2

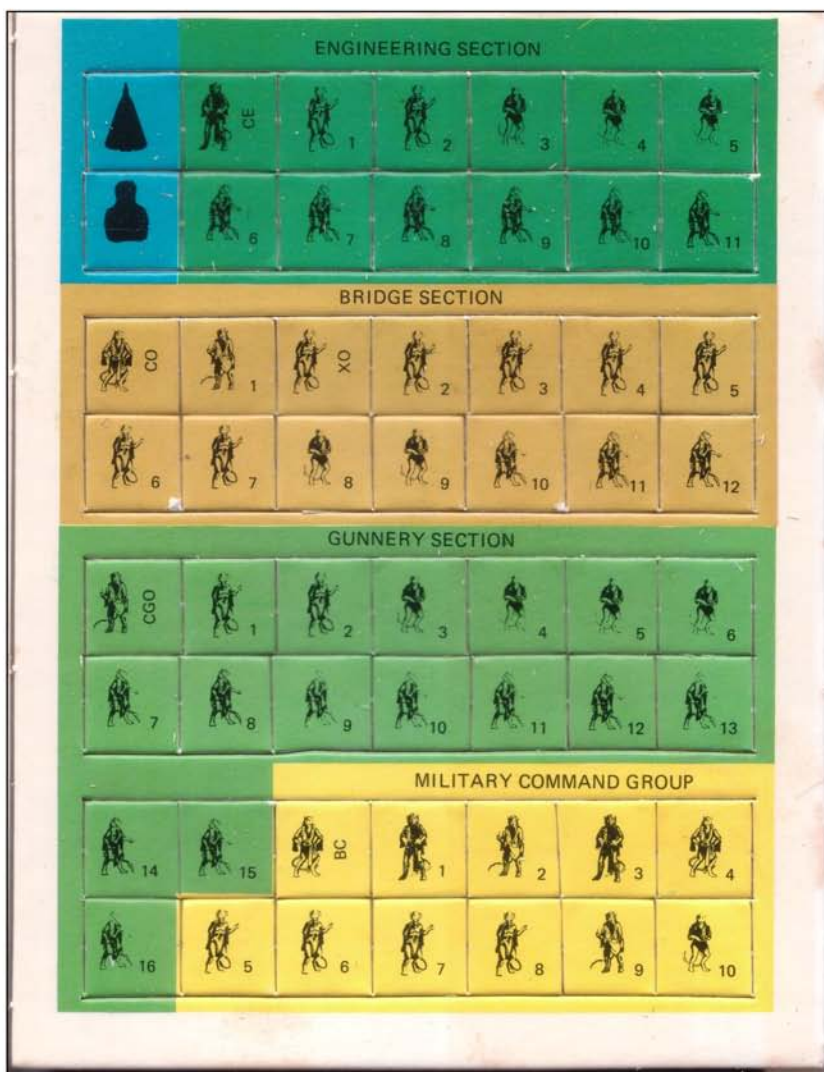

SPECIALTY PLATOONS

A variety of additional platoon-sized units, not integral to any particular company, are also available to the regiment for special assignments and operations. Room to carry one such special platoon is provided aboard each company transport. These positions may be left vacant on independent missions, or may be filled by a specialty platoon deemed useful for the operation in question.

Combat Platoons: These platoons are essentially identical to those which are assigned to each company. They are often added to a regular company to provide additional firepower to a standard unit. There are three such platoons in the regiment at this time.

Commando Platoon: One platoon of elite troops, heavily trained in special operations (recon, demolitions, and other tasks) is available to the regiment. Members of the unit are equipped with grav belts for mobility. Unlike other fighting units, the commando platoon does not have a fire support vehicle present.

Engineering Platoon: One platoon available to the regiment consists of females and low-caste males trained in combat engineering. The unit is built around one (sometimes two) vehicles fitted for engineering work, equipped with a bulldozer blade, special detection devices, demolitions gear, and other engineer's tools. Thin engineering APC can carry one section (nineteen men): this includes the vehicle's driver.

Recon Platoons: The regiment has two recon platoons available for scouting purposes. Recon platoons are very lightly equipped. No fire support vehicles are provided for them. The well-trained picked troops in these units are all equipped with grav belts for individual mobility; at times, though, gravcycles (individual anti-grav vehicles) are substituted instead. The unit acts as a scouting force, and as a mobile screen probing ahead of an advancing force. In combat, harrassment tactics are heavily employed by such platoons.

Regimental Artillery: Two artillery support units are available to the regiment, in addition to the battery-sized force attached to the headquarters ship. These smaller units consist of a commander — male — who controls the unit's command observation post. He is supported by a small female staff and a squad of combat troops, and acts as the forward observer for the actual artillery. The remainder of the unit — the artillery itself — is composed of females and lowerclass males who actually control the guns. These guns are, usually, mass drivers or MRLs.

A female officer skilled in forward observation techniques is used to call in fire by these vehicles. The company commander assigns her to individual platoons which will be in need of support.

Headquarters Platoons: Each Battle Group includes a headquarters platoon. This unit is basically similar to the standard combat platoon, but lacks a direct fire support vehicle. Eight of the ten air/rafts on board a Battle Leader are used by the HQ platoon (which has sufficient drivers) to give the force a great deal of mobility on the field of battle.



LIBRARY DATA

Aslan: The Aslan are a race of intelligent beings with an established empire spinward and rimward of the Imperium; in addition, large numbers have settled within the Imperium. Aslan stand roughly human-sized, averaging 2.0 meters in height and weighing about 100 kg. They are descended from four-limbed upright, bipedal carnivore/pouncer stock, originally adapted to a solitary arboreal existence. The earliest Terran explorers saw in them a vague resemblance to the Terran lion, and they have been described (by Terrans) as lion-like ever since, although there is very little true similarity. The derivation of the word Aslan is unknown. There are two sexes, male and female. The most notable external difference is the increased size and mane of the former. Females outnumber males by 3:1.

Aslan have a single highly specialized claw under each thumb which folds back jackknife fashion into a horny covering in the base of the thumb and palm.

A vast Aslan-dominated empire (the Aslan Hierate) lies far to rimward; but Aslan themselves have ranged far beyond its borders, with many settling within the Imperium and attaining full status as citizens. As citizens, they subordinate themselves to Imperial authority, although they have remained culturally apart from human society. Aslan serve in the Imperial armed forces; they achieve noble positions; they pay taxes; they run businesses.

Aslan Society: The Aslan are a warrior race, proud and noble, devoted to those in authority above them. An individual Aslan is usually a member of a family of from 2 to 12 individuals under a patriarchal leader. Several families will combine into a pride with one family dominant. A number of prides form a clan again with a top pride. Aside from military organizations and the ruling council (within the Hierate), the clan is the highest socio-political organization among the Aslan.

A deep-seated territorial instinct causes the Aslan to have an inordinate (from a human standpoint) concern with land. For male Aslan, owning land is a major goal in life. An Aslan's stature is determined by the amount of land he (or her husband) controls, and the amount of land controlled by any higher lord under whom he may be vassal. The lowest classes of Aslan are landless, and provide the farmers, laborers, craftsmen, and factory workers. A holder of large territory will often grant authority over it to vassals (usually sons, brothers, or male relatives by marriage) who administer the land in his name.

The sexes have very different roles in Aslan society. Males (in all but the lowest classes) are concerned mostly with military operations, acquisition of territory, and political affairs. Females are concerned with trade, industry, and the accumulation of knowledge. Upper class males have little conception of money and are literally incapable of functioning in a technological society without aid, and are thus seldom encountered without the supervision of a wife, mother, or other female relative or employer. For instance, a typical Aslan mercenary unit will be organized by a wealthy married female, who will then assign its operation, for a share of the proceeds, to an unmarried female relative. The battle commander and most of the troops will be unmarried males (many of them also relatives), hired with the promise of land grants (and the opportunity to gain honor and reputation in combat); however, staff, operations, supply, and intelligence officers will generally be female.

Aslan Hierate: Interstellar, multi-sector government of the many Aslan clans. Aslan society centers on the clan. Within the Hierate, the family structure of the Aslan and the governmental structure are the same. The highest governmental

functions are performed by a council of twenty-nine clan leaders chosen from amongst the most powerful clans. "The 29" (as they are called) have quasireligious status and represent the essential unity of the Aslan race. To be chosen on of "The 29" is the highest honor to which any Aslan can aspire. The 29 meet continuously on Kuzu to adjudicate inter-clan disputes and decide matters of group policy. No member of the 29 speaks for the Hierate as a whole, nor does the whole 29.

There are no Hierate military forces; each clan is its own, and they rarely act in concert with those of other clans. The Hierate itself can call upon military forces only insofar as the clans themselves agree to provide such forces. Even the minor forces conveying the 29's decisions are actually under the control of individual clan leaders.

The Military: There are no Hierate military forces; each clan retains its own, and they rarely act in concert with other armies. For the lower classes and the second sons of most classes, service in the military is the quickest way to gain a landhold. In addition to medals, Aslan warriors are often granted estates for acts of extreme gallantry, and officers are sometimes given conquered territory along the frontiers to administer.

The military is the segment of the Aslan culture which is the least family oriented, since soldiers are drawn from all social classes (mostly lower class and second sons).

Aslan in the Imperium: Large numbers of Aslan have settled outside the Hierate borders. Entire planets of Aslan lie within the Imperium, swearing fealty to the emperor and holding land from him personally. Aslan mercenary units are in great demand (even though they must be employed in all-Aslan units because of their equipment requirements) and Aslan merchants ply trade routes throughout most of known space.

PLAYING THE ASLAN

The player who chooses to be an Aslan should bear in mind that while they have many similarities to humans, they are not human, and should not be played as such. Two hints for the prospective Aslan:

1. The underlying characteristics of Aslan society (pride and loyalty) make behavior much like samurai of the "Age of War".
2. Avoid actions that are out of character. Aslan, for example, are very loyal to their friends, and it is inconceivable for an Aslan to desert a friend in danger if there is a chance of rescue.

The six basic characteristics are determined as per book 1, page 4, with the following exceptions: Add 1 to the strength and endurance throws: subtract 1 from the dexterity throw. Social standing applies only to inter-Aslan relations.

Skills may be acquired as per books 1, 4, or 5. Brawling and blade skills automatically become dewclaw skill. In combat, treat the dewclaw as a knife. Aslan receive +1 to their morale throws if using Book 1, +2 if determining morale for a unit of Aslan per Book 4.

The Unit Symbol



UNIT TYPES

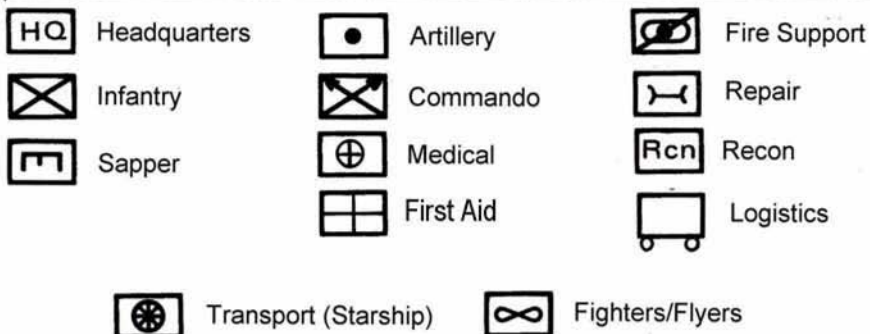

UNIT SIZES

