

# STAR FLEET BATTLES

## CAPTAIN'S EDITION BASIC SET



**TASK  
FORCE  
GAMES™**

M. WINTERBAUER

# STAR FLEET BATTLES

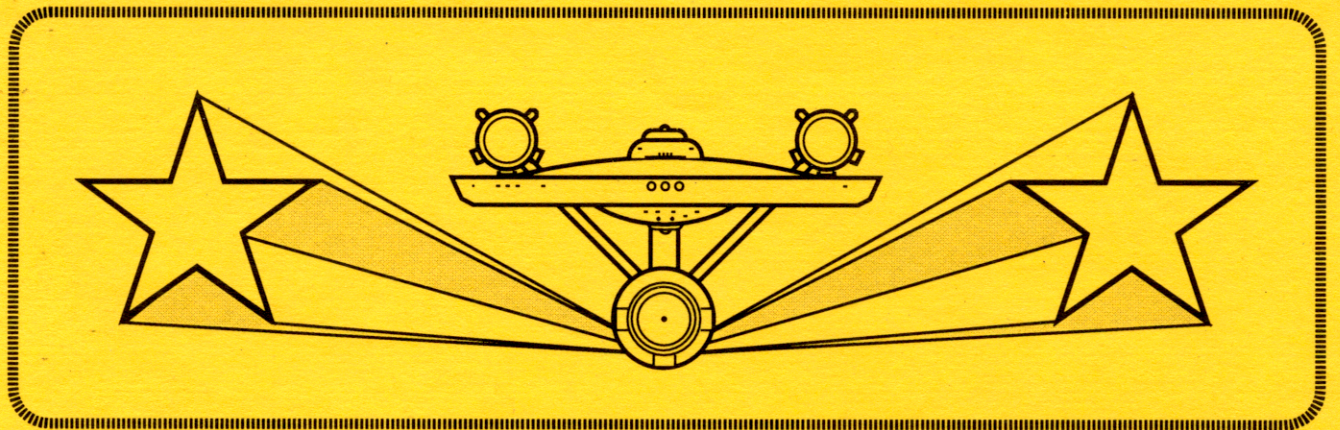

## CAPTAIN'S BASIC RULEBOOK

BASIC GAME RULES

NAVIGATION & MANEUVER

WEAPON SPECIFICATIONS

SYSTEM PARAMETERS

STARSHIP DESCRIPTIONS

MISSION ASSIGNMENTS

DATA TABLES AND ANNEXES



1999

ADB  
INC.

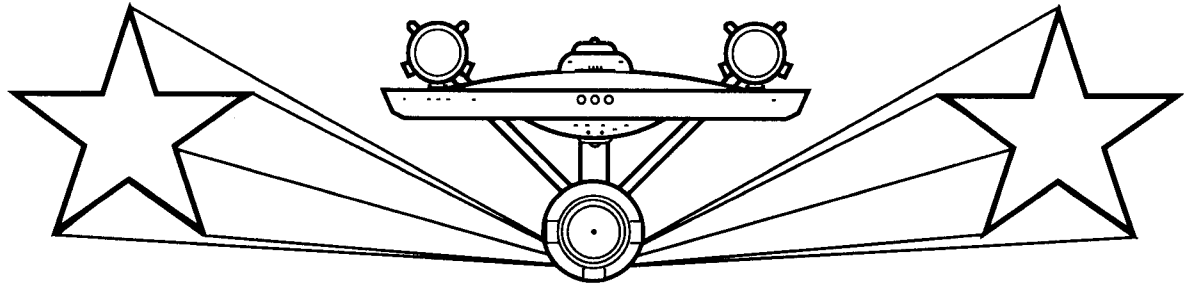

# STAR FLEET BATTLES THE CAPTAIN'S EDITION

is dedicated to

THE CAPTAINS

from all nations, creeds, and eras;  
of the hundreds, the thousands, and the millions;  
of the land, the sea, and the sky;

who led men into battle  
to fight for what they believed in.

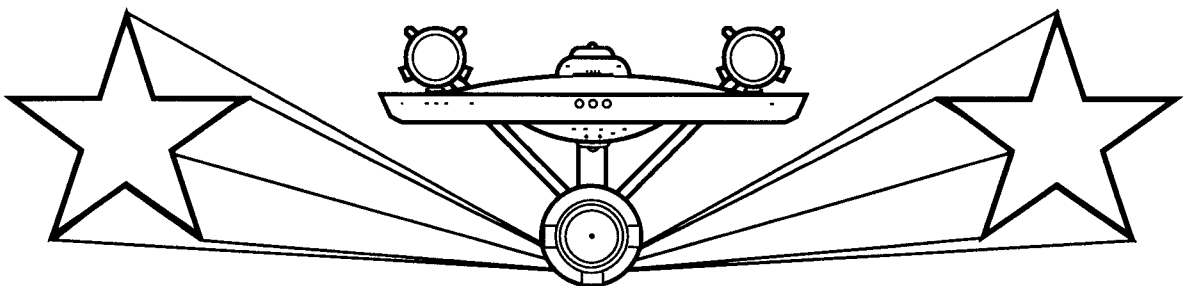

THIRD EDITION, MAY 1999

**A0.0 GENERAL RULES**

- A1.0 INTRODUCTION
- A2.0 GENERAL COURSE OF PLAY
- A3.0 GENERAL INFORMATION
  - A3.1 RULES ORGANIZATION
  - A3.2 GAME EQUIPMENT
  - A3.3 BACKGROUND
  - A3.4 SCALE
- A4.0 CADET'S GAME
- A5.0 SAMPLE GAME

**B0.0 HOW TO PLAY**

- B1.0 GENERAL INSTRUCTIONS
- B2.0 SEQUENCE OF PLAY
- B3.0 ENERGY ALLOCATION

**C0.0 MOVEMENT**

- C1.0 GENERAL RULES
  - C1.1 PROCEDURE
  - C1.2 FACING
  - C1.3 PLOTTING
    - C1.31 FREE MOVEMENT
    - C1.32 PLOTTED MOVEMENT
  - C1.4 PERFORMING MOVEMENT
- C2.0 ENERGY COST OF MOVEMENT
  - C2.1 GENERAL PROCEDURE
  - C2.2 ACCELERATION
- C3.0 TURNING AND TURN MODES
  - C3.1 TURNING
  - C3.2 DEFINITION OF TURN MODE
  - C3.3 ASSIGNMENT
  - C3.4 RESTRICTIONS
  - C3.5 REVERSING DIRECTION
  - C3.6 QUICK REVERSE
  - C3.7 BASE ROTATION
  - C3.8 DIRECTED TURN MODES
- C4.0 SIDESLIP
- C5.0 TACTICAL MANEUVERS
- C6.0 HIGH ENERGY TURNS
  - C6.5 BREAKDOWN
- C7.0 DISENGAGEMENT
  - C7.1 ACCELERATION
  - C7.2 SEPARATION
  - C7.3 SUBLIGHT EVASION
  - C7.4 AUTOMATIC DISENGAGEMENT
- C8.0 EMERGENCY DECELERATION
- C9.0 POSITRON FLYWHEEL

**D0.0 COMBAT**

- D1.0 GENERAL RULES
- D2.0 FIRING ARCS
- D3.0 SHIELDS
- D4.0 DAMAGE ALLOCATION
- D5.0 SELF-DESTRUCTION
- D6.0 FIRE CONTROL SYSTEMS
  - D6.1 SENSORS
  - D6.2 SCANNERS
  - D6.3 ELECTRONIC WARFARE
  - D6.4 NON-VIOLENT COMBAT
  - D6.5 UIMs
  - D6.6 ACTIVE FIRE CONTROL
  - D6.7 LOW-POWER FIRE CONTROL
- D7.0 SPACE MARINE BOARDING PARTIES
- D8.0 CRITICAL HITS
- D9.0 DAMAGE CONTROL

**E0.0 DIRECT-FIRE WEAPONS**

- E1.0 GENERAL RULES
- E2.0 PHASERS
- E3.0 DISRUPTOR BOLTS
- E4.0 PHOTON TORPEDOES
- E5.0 ANTI-DRONES
- E6.0 MONSTER CLOSE-IN DEFENSE

**F0.0 SEEKING WEAPONS**

- F1.0 GENERAL RULES
- F2.0 SEEKING WEAPON MOVEMENT
- F3.0 SEEKING WEAPON GUIDANCE
- F4.0 BALLISTIC TARGETING

**FD0.0 DRONES**

- FD1.0 GENERAL RULES
- FD2.0 TYPES OF DRONES
- FD3.0 TYPES OF DRONE RACKS
- FD4.0 FIRING RATES
- FD5.0 METHODS OF CONTROL

**FP0.0 PLASMA TORPEDOES**

- FP1.0 GENERAL RULES
- FP2.0 TYPES OF PLASMA TORPEDOES
- FP3.0 FIRING ARCS AND LAUNCHERS
- FP4.0 PLASMA TORPEDO GUIDANCE
- FP5.0 ENVELOPING PLASMA TORPEDOES
- FP6.0 PSEUDO-PLASMA TORPEDOES
- FP7.0 PLASMA SHOTGUN
- FP8.0 PLASMA BOLTS

**G0.0 SHIP'S SYSTEMS**

- G1.0 GENERAL RULES
- G2.0 CONTROL SYSTEMS
- G3.0 HULL
- G4.0 LAB
- G5.0 PROBES
- G6.0 SECURITY STATIONS AND KLINGON MUTINY
- G7.0 TRACTOR BEAMS
- G8.0 TRANSPORTERS
- G9.0 CREW UNITS
- G10.0 THE THOLIAN WEB DEVICE
- G13.0 CLOAKING DEVICES
- G14.0 TUGS AND PODS
- G15.0 ORION PIRATES SPECIAL RULES

**H0.0 POWER SYSTEMS**

- H1.0 GENERAL RULES
- H2.0 WARP ENGINES
- H3.0 IMPULSE ENGINES
- H4.0 AUXILIARY POWER REACTORS
- H5.0 BATTERIES
- H6.0 PHASER CAPACITORS
- H7.0 RESERVE POWER

**J0.0 SHUTTLECRAFT**

- J1.0 GENERAL RULES
- J2.0 ADMINISTRATIVE SHUTTLES
- J3.0 WILD WEASELS
- J4.0 FIGHTERS

**M0.0 MINE WARFARE**

- M1.0 GENERAL RULES
- M2.0 ROMULAN SPACE MINES
- M3.0 TRANSPORTER BOMBS

**P0.0 TERRAIN**

- P1.0 GENERAL RULES
- P2.0 PLANETS
  - P2.1 GENERAL RULES
  - P2.2 TYPES OF PLANETS
    - P2.21 CLASS M
    - P2.22 GAS GIANTS
    - P2.23 SMALL MOONS
- P2.3 EFFECTS OF PLANETS ON COMBAT
- P2.4 LANDING ON PLANETS

- P2.5 EFFECTS OF ATMOSPHERE ON COMBAT

- P2.6 STRUCTURE OF PLANETS AND ATMOSPHERES

- P3.0 ASTEROIDS
- P4.0 BLACK HOLE
- P5.0 VARIABLE PULSAR
- P6.0 NEBULA

**R0.0 RACES, BACKGROUND, AND STARSHIP DATA**

- R1.0 GENERAL
- R2.0 UNITED FEDERATION OF PLANETS
- R3.0 THE KLINGON EMPIRE
- R4.0 THE ROMULAN STAR EMPIRE
- R5.0 THE KZINTI HEGEMONY
- R6.0 THE GORN CONFEDERATION
- R7.0 THE THOLIAN HOLDFAST
- R8.0 THE ORION PIRATES

**S0.0 SCENARIOS**

- S1.0 GENERAL RULES
- S2.0 VICTORY CONDITIONS
- S3.0 PLAY BALANCE
- S4.0 WEAPONS ARMED STATUS
- S5.0 LOCAL CONDITIONS
- S6.0 DEFEATING MONSTERS

**SG0.0 GENERAL SCENARIOS**

- SG1.0 THE DUEL
- SG2.0 FLEET ACTION
- SG3.0 BASE DEFENSE
- SG4.0 BASIC PIRACY
- SG5.0 DUEL WITH A PIRATE
- SG6.0 PURSUIT INTO THE ASTEROIDS
- SG7.0 PIRATES GO FOR BIG GAME
- SG8.0 ASSAULT ON A STARBASE
- SG9.0 A VERY SPECIAL ALLY

**SH0.0 HISTORICAL SCENARIOS**

- SH1.0 SABOTAGE!
- SH2.0 THE SURPRISE REVERSED
- SH3.0 THE COMING OF THE METEOR
- SH4.0 CRUISE DRONES
- SH5.0 ATTACK SHUTTLE GROUP #26

**SM0.0 MONSTER SCENARIOS**

- SM1.0 THE PLANET CRUSHER
- SM2.0 THE SPACE AMOEBIA
- SM3.0 THE MORAY EEL OF SPACE
- SM4.0 THE COSMIC CLOUD

**T0.0 MINI-CAMPAIGNS**

- T1.0 GENERAL RULES
- T2.0 ECONOMY OF FORCE

**U0.0 CAMPAIGN GAMES**

- U1.0 GENERAL RULES
- U2.0 THE CAPTAIN'S GAME

**Z0.0 DESIGNER'S NOTES, PUBLISHER'S INFORMATION**

- Z1.0 DESIGNER'S NOTES
- Z2.0 ADVICE ON TACTICS
- Z3.0 NOTICE TO NEW PLAYERS OF SIMULATION GAMES
- Z4.0 DESIGN CREDITS
- Z5.0 THE STAR FLEET UNIVERSE
- Z6.0 COPYRIGHT AND PUBLISHER'S INFO

**(A0.0) GENERAL RULES****(A1.0) INTRODUCTION**

*STAR FLEET BATTLES* (SFB) is a game of starships. Each player in the game will personally command one starship (or sometimes more) which he will use in various scenarios to perform assigned missions.

Starships in this game are portrayed at a level of detail and accuracy which had never been achieved when *STAR FLEET BATTLES* first appeared in 1979. Many games have imitated this level of detail in the last decade, but *STAR FLEET BATTLES* has continued to evolve and grow.

*STAR FLEET BATTLES* is, at the same time, both complex in its mechanics and simple in its execution. Many things that sound difficult upon first reading the rules will become clear as the players attempt them. Starship captains undergo years of training for their jobs; don't expect to master this game in a day. But conversely, you need not concern yourself with the thousands of details faced by a starship captain, who spends over half his time on administrative problems (something that you, the game player, will not have to bother with).

**(A1.1) INTRODUCTION TO THE CAPTAIN'S EDITION**

**(A1.11) PREVIOUS EDITIONS:** The Captain's Edition is the fourth edition of *STAR FLEET BATTLES* to appear in print. This section (A1.1) explains the various editions; you need not read it immediately.

*STAR FLEET BATTLES* was designed in 1975 and published in 1979 as a 28-page "Pocket Edition" game with 14 starships, 7 scenarios, and 108 counters.

The instant popularity of the game resulted in the 1980 boxed Designer's Edition (roughly twice as large) and three expansions (each the size of the original pocket game). The combined Designer's Edition included a total of 174 pages, 540 counters, 41 scenarios, 5 campaigns, and about 180 different starships.

In 1983-5, the Commander's Edition appeared and replaced the two earlier versions of the game. Many rules were overhauled, and many more were added. During 1986-9, many products were added to the game system, most of which will eventually be revised and re-issued as part of the Captain's Edition.

**(A1.12) NOTES TO NEW PLAYERS:** If this is your first experience in *STAR FLEET BATTLES*, or your first in some time, you will have the advantage of a completed rules set without having to wade through years of rules changes and additions, but you will run into a few "ghosts" and curiosities.

It may appear to new gamers that a lot of the game is missing, but this is not really the case. For example, rule (G13.57) in the Cloaking Device section refers to rule (G23.0) Expanding Sphere Generators. Going to the end of the G section in Basic Set [which ends with (G15.0)], you find a note that (G23.0) is in Module C1, which you don't have. (At the end of each section of Basic Set you will find a synopsis of the other rules.) You will find many similar rules references in Basic Set to rules in other products. This does not mean that you are forced to buy Module C1; it does mean that if you do choose to buy C1 your Basic Set has already been designed to work with it.

In all such cases where a rule you do not have provides a penalty, an exception, a condition, an opportunity, or whatever, simply ignore it. Consider it in the spirit of a baseball rulebook that includes a note saying "if playing in snow, see the rules in a separate book on sliding into bases while wearing snowshoes." Unless and until you decide to play baseball in the snow, you simply do not need the snowshoe rules.

The greatest oddity for a new player is in the rule sequencing. The rule numbers (also used for ships and scenarios) are those assigned when any given rule first appeared in the Commander's Edition. (These were kept unchanged so those players with some Commander's products and some Captain's products could look up cross-references to various rules.) Thus, you will find rule (E6.0) in Basic Set, (E7.0) in Module C1, (E8.0) in Advanced Missions, (E9.0) in Module C2, (E10.0) back in Module C1, and finally (E11.0)-(13.0)

back in Module C2. Since these are all printed on separate pages, you can put them together in order in your own binder, but even so it may seem a bit curious. If we were doing *STAR FLEET BATTLES* from scratch, doubtless each sequence would be in one product.

Another example is rules (G11.0) and (G12.0) which are "missing" from Basic Set [which includes (G1.0)-(G10.0) and (G13.0-G15.0)]. These are complicated optional rules that were moved to Advanced Missions in order to avoid burdening novice players with them until they were ready.

The fact that there are references to other products does *not* in any way mean that you have to buy them, or that you won't get full enjoyment out of this product without them, or that you are less worthy of sitting in the captain's chair than someone who does. The Basic Set is a complete starship combat game in its own right.

Two curiosities are found in the ship section for Basic Set. Each ship in the game (in all current products there are almost 800) has a unique number. These numbers were assigned in sequence as the game grew through the decade of the 80s. This volume includes Kzinti ships (R5.2) through (R5.8), but also includes (R5.20). This happened because (R5.20) is needed as an escort for (R5.6), but when (R5.6) was first published in 1980, we did not assign it formal escorts. The escorts [i.e., (R5.20)] were created in 1984, by which time the intervening numbers had been used for other ships. We could not give you Kzinti ships (R5.9) through (R5.19) in this volume without adding a considerable quantity of advanced rules and SSDs that a beginning player should not have to deal with.

The other curious ship is (R1.13), the small auxiliary carrier. When scenario (SH5.0) was first published in 1980, we told the players to use a small freighter (R1.5), which was employed by the Kzintis to bring fighters to the front lines. By 1984 this seemed to be such a useful function that a formal ship [the small auxiliary carrier in (R1.13)] was invented to fulfill it, but again, the intervening numbers had already been used and (you guessed it) we can't give you general ships (R1.8) through (R1.12) without involving you in a lot of rules that you can go looking for when you are ready.

**(A1.13) NOTES TO VETERAN PLAYERS:** Veterans of SFB (who have awaited the "Doomsday" edition with considerable excitement and a measure of skepticism) will find what they have long wanted.

All of the addenda has been absorbed into the rules.

All of the quirks, loopholes, imbalances, and undefined areas have been eliminated, but nothing was changed just for the sake of making a change.

All of the new concepts (such as active fire control) that were added to the game later have been fully integrated into the basic rules, and some new sections have been added (and fully integrated).

*BASIC SET* is roughly equivalent to the old Volume I. *Module K* is roughly equivalent to the old Supplement #3. Everything else has been shuffled around into new products, not simply to do something different or to drive you to distraction, but to put things into a more logical sequence of products with which to build your game system. See (Z5.0) for a list of all products in the Star Fleet Universe of games.

**(A1.2) STAR FLEET 2300 MINIATURES**

The game as presented in this package uses die-cut playing pieces to represent the starships, planets, asteroids, shuttlecraft, drones, monsters, etc. used in the game. There is an alternative, however, that will dramatically increase the visual imagery of the game: miniature starships. As this edition goes to press, ADB Inc. is preparing to release a new range of scale starship miniatures. Ask your game retailer for the latest information on these.

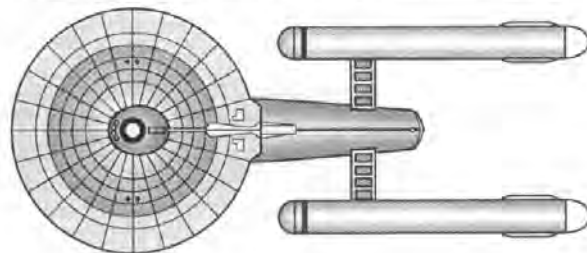

**(A1.3) SOURCE DATA**

At some point prior to 1970, the master computer at U.S. Air Force Security Control in Omaha, Nebraska, received a transmission, apparently via a time warp, from Star Fleet Headquarters some 250 years in the future. The Air Force discovered this information during 1970, and turned it over to Franz Joseph Designs, an aerospace-consulting firm, in 1973 for analysis.

The memory files, which comprise several thousand printed pages and were badly garbled in transmission and translation, appear to be a history of the United Federation of Planets, its Star Fleet, and nearby regions of the galaxy, including a considerable amount of technical data.

Through the cooperation between Franz Joseph Designs and Amarillo Design Bureau, this data (a very small portion of which was published earlier as the Star Fleet Technical Manual) has been used as a basis for this game. Changes made in the rules and history reflect additional information obtained from the tapes. At present, about 65% of the material has yet to be translated or analyzed. As more data is translated (by our dedicated staff), it will be used as the basis for additional games and supplements.

**(A2.0) GENERAL COURSE OF PLAY**

The game is divided into scenarios, which are specific missions (usually combat against enemy starships or other units). Each scenario is played in turns, and each turn is divided into several phases and a number of "impulses."

During each turn, the players will determine the amount of energy that is available from engines, reactors, and batteries and will allocate this power to move, fire weapons, operate shields, and use other instruments and equipment.

Then the starships in the scenario will actually be moved (using a proportional movement system to reflect relative speed) and will fire their weapons during movement as the "enemy" starships come within optimum range.

Damage is recorded on ship systems displays. These are a stylized layout of the ship with small boxes labeled for each of the various systems. As the ship takes damage in combat, the boxes are checked off. The ship's systems display is used to determine just what systems are still operating.

Play generally continues until one player has taken so much damage that his ship no longer has a chance of winning, and attempts to escape at high trans-light speed or other means. The player who managed to keep his ship relatively undamaged while damaging the enemy ship (or ships) wins the scenario.

In some cases, the enemy might be a "monster" of one type or another. These scenarios can be particularly challenging.

**(A2.1) BASIC CONCEPTS**

There are three basic concepts in *STAR FLEET BATTLES* that must be understood and mastered in order to get the most out of the game. These are ENERGY ALLOCATION, the SHIP SYSTEMS DISPLAY, and PROPORTIONAL MOVEMENT.

The Energy Allocation (EA) system is basically a management tool. Power can be drawn from the warp (anti-matter) engines, the impulse (nuclear ionic) engines, the auxiliary (nuclear) reactors, and (for short periods) from batteries. This is recorded on a special Energy Allocation Form (EAF), but is not a simple total. Movement at speeds greater than one hex per turn requires warp energy, as do certain weapons. Generally, there is never enough energy to move at full speed, fire all weapons, and operate all of the other equipment on the ship at the same time.

The Ship Systems Display (SSD) is the second basic concept. Each box on the SSD represents a specific piece of equipment, which has certain requirements and capabilities. The more boxes there are (or that remain unmarked) on the SSD, the more powerful the ship.

Proportional Movement is difficult to explain but relatively easy to perform. Each ship (or other unit) moves a number of hexes each turn. The exact number is determined by the energy allocated to movement. Each turn is divided into 32 impulses. A ship that is moving at a speed of 16 hexes per turn will move in every other impulse. A ship moving at a speed of 10 hexes per turn will move in

(approximately) every third impulse. Thus, all ships are continuously moving throughout the entire turn, but at the proper and relative rates of speed. This system closely approximates reality. This system is superior to systems where first one player moves his units and then the other player moves his, and to systems where all units move at the same speed but some stop moving during the middle of the turn while other, faster, ships keep moving.

**(A3.0) GENERAL INFORMATION****(A3.1) RULES ORGANIZATION**

Each rule in the CAPTAIN'S EDITION of *STAR FLEET BATTLES* is assigned an alphanumeric designation referred to as a "rule number." This system is organized in a hierarchy, reading left to right.

**(A3.11) SECTIONS:** The game is divided into sections, each designated by a letter. For example, you are now in "section A" which deals with "General Rules and Information." All rule numbers in section A begin with the letter "A" as in (A3.11), the number of this rule.

**(A3.12) SYSTEMS:** After the letter and before the decimal point are one or two digits which refer to a specific system, weapon, or major group of rules. These are read consecutively, and there is no particular relationship between, say, rule (G5.0) and (G15.0).

The letter and numbers to the left of the decimal point will bring you to a rule concerning one specific subject. For example, section (E0.0) concerns direct-fire weapons, while (E2.0) concerns phasers and (E4.0) concerns photon torpedoes. The system works from left to right, from the general to the more and more specific.

**(A3.13) SUBDIVISIONS OF THE RULES:** To the right of the decimal point, the numbers work somewhat differently. Rule (E1.23), for example, is not the 23rd thing the designer wanted to say about rule (E1.0), but the third thing about the second topic under subject #1.

For example, section (E3.0) refers to the disruptor bolts mounted on Klingon (and some other) starships. Rule (E3.1) identifies which boxes on the SSDs are disruptors; (E3.2) explains how to fire them; (E3.3) tells how to determine the amount of damage they cause; (E3.4) is the probability table used to resolve disruptor fire; (E3.5) describes how disruptors can be "overloaded" for additional effect at shorter ranges; and (E3.6) explains the effect of certain advanced targeting and fire-control systems on disruptor fire. There is no rule (E3.7) or (E3.8) because only six topics within the subject of disruptor bolts require discussion.

Rules (E3.20) through (E3.24) describe certain additional rules, restrictions, or information about firing disruptor bolts, i.e., rule (E3.2). These rules come between rules (E3.2) and (E3.3), not after them. In outline form, this would appear as:

**E0.0 DIRECT FIRE WEAPONS**

(E1.0) GENERAL

(E2.0) PHASERS

(E3.0) DISRUPTORS

(E3.1) Boxes on the SSD

(E3.2) How to fire disruptors

(E3.20) Procedures

(E3.21) Energy required

(E3.22) Firing disruptors

(E3.23) How often they can fire

(E3.24) Must be fired when armed

(E3.3) Damage caused by disruptors

(E3.4) Disruptor Chart

(E3.5) Overloaded disruptors

(E3.6) Advanced Fire Control

(E3.61) Ubitron Interface Modules

(E3.62) Disruptor Extended Range Fire Control

**(A3.14) EXCEPTIONS IN RULE NUMBERING:** As with all things, there are exceptions to the rules about the organization of the rules.

Section F, which deals with "seeking weapons" (those that home in on their targets), is divided into three major parts. Rules dealing with missiles (called drones in SFB) begin with FD, while rules

dealing with plasma torpedoes begin with FP. Other than having two letter superscripts, the rules work normally within those sections. Rules basic to both types of seeking weapons are designated F (known as F-Prime, a plain "F" including F-Prime, FD, and FP).

Section S (scenarios, the battle incidents you will be playing) is divided into general scenarios (SG), historical scenarios (SH), and monster scenarios (SM).

There is a further exception in section R, which deals with specific information about each unit (starship, base, fighter) in the game. In that section, and in that section only, numbers to the right of the decimal are fully consecutive. In this section only, rule (R2.11) comes after (R2.10), not between (R2.1) and (R2.2). Section R is home to another exception, letters after the decimal. Rule (R2.R1) is the first Federation refit, (R2.F3) is the third Federation fighter, and (R3.PF1) is the first Klingon PF (Fast Patrol Ship).

Sections T and U (campaigns) include scenarios (for example) designated (T2S1.0), i.e., scenario #1 that is part of Campaign T2.

**(A3.15) LEVELS OF RULES:** Rules in *CAPTAIN'S STAR FLEET BATTLES* are divided into several levels of complexity. Rules not otherwise marked are part of the *STANDARD GAME*. These are rules that should be learned and mastered; they are the core of the game.

Some of these rules are assigned by (A4.0) as part of the *CADET'S GAME*; a very simplified version designed to allow players to gain experience with the game after a very short period of study.

Some rules are marked as *ADVANCED*. These are rules that should be learned in order to experience the full enjoyment and challenge of the game. Players should master the *STANDARD GAME* before using any of the *ADVANCED RULES*. The "Advanced Game" is balanced as an integrated whole; if you use only some of the Advanced Rules you may experience problems with play balance.

The highest level is the *COMMANDER'S LEVEL RULES*, which are for the most experienced players. These rules are very complex and require considerable knowledge of the entire game system. The "Commander's Game" is balanced as an integrated whole; if you use only some of the Commander's Level Rules you may experience problems with play balance. Remember, each level of more advanced rules makes the game more complicated, but also makes it possible to get more out of your ship.

Then there are the *OPTIONAL RULES*. These rules are not necessary to play most of the scenarios, but may be used to add increased challenge, interest, or just to do something different. The use of optional rules requires the mutual consent of all players in the scenario. The inclusion or exclusion of any given optional rule should not affect play balance (except in obvious cases where only one side can use a given rule). Some optional rules are marked both "Commanders" and "Optional." These rules are optional, but are particularly detailed.

**(A3.16) ANNEXES:** Some information changes with every expansion to the game. The prime example is the *MASTER SHIP CHART*, which lists every ship in the game. Obviously, since each expansion adds new starships, the chart must be replaced with a new one listing all of the old ships together with all of the new ones. (Otherwise you would have six or more charts and not know which one had the Klingon D6 without checking all of them.) A series of annexes provides a capability to continually update the primary data of the game with each expansion.

It should be noted that the annexes provided with *BASIC SET* cover only the material in this product. Each additional product then expands or replaces the relevant annexes.

**(A3.17) EXCEPTIONS TO RULES:** Many rules have exceptions in other rules. Often, the exceptions to a given rule will be cited by cross-reference within it. For example, rule (D3.21) covers internal damage, but the two exceptions listed indicate cases when this damage is prevented.

The absence of such a cross-reference, however, does not invalidate the exception. If rule A states an exception to rule B, and rule B does not mention this exception, the exception is still valid. Usually this is done only in specialized cases. For example, just about every weapons rule should include mention that the range is limited while in a Radiation Zone (P15.0), but that would add dozens of such references and clutter the game. The designer has assumed that if you are playing a scenario in a Radiation Zone you will read the rule on such zones before starting play.

## (A3.2) GAME EQUIPMENT

**(A3.20) BOXED BASIC SET:** Included in the boxed *STAR FLEET BATTLES BASIC SET* are:

- ★ one 224-page rules book (this one).
- ★ one 24" x 20" playing map.
- ★ two six-sided dice. (Never use any dice but six-sided dice with this game. Using 12-sided dice will alter the probability structure.)
- ★ 216 die-cut multi-colored playing pieces (two sheets).
- ★ one 48-page SSD booklet with starship diagrams needed for play. These Ship Systems Displays (SSDs) should be kept for use as originals. Do not mark on them.
- ★ an 11x17" card with the Damage Allocation Chart, 32-Impulse Movement Chart, and two copies of the Energy Allocation Form. Do not mark on this card; use it as an original to produce photocopies for use in playing the game.
- ★ a 16-page "starter booklet" with four Federation CA SSDs, four Klingon D7 SSDs, and eight copies of the Energy Allocation Form. These copies can be written on and discarded after use. They should provide you with enough for your first gaming session, after which you can photocopy more from the originals or use plastic page protectors and erasable markers. (Some copies of the game have this 16-page starter booklet bound into the center of the 48-page SSD book. Be careful when removing these starter SSDs and do not confuse them with the masters.)

**CAPTAIN'S RULEBOOK:** If your copy of the Basic Set rulebook was included in the separate Captain's Rulebook (along with the rules to Advanced Missions, Module C1, and Module C2), the components above (except for this rulebook) will not be included.

**COPIES OF FORMS:** You will need a copy of the SSD and an Energy Allocation Form for each ship in the scenario each time you play. Since you must write on these forms to play the game, you will have to obtain copies of them. You might wish to use photocopies or have a local quick printer run off a hundred copies of your favorite ship. Players may wish to use marking pencils and page protectors (wiping the sheet clean after each use); some players have had their sheets laminated. Purchasers of this game have the permission of the publishers to produce, by any convenient means, copies of the SSD sheets, Energy Allocation Forms, and movement charts for their own private use (and the use of their opponents). Reproduction for sale or in publications is NOT authorized.

### (A3.21) COUNTERS (PLAYING PIECES)

**(A3.211)** The die-cut counters are used to represent the various starships and weapons which are used in the play of *STAR FLEET BATTLES*. Generally, each counter represents one starship, weapon, shuttle, monster, etc.

**(A3.212)** The race/nation/empire of the counter is shown by its color. Because each new product adds new counters with new races, the colors are given in Annex #7A.

**(A3.213)** Each counter displays a top view silhouette of the ship represented as well as an identifying abbreviation to more readily distinguish ship types and an identification number to distinguish one ship from another of the same type. The abbreviation is used on the Master Ship Chart and in the Ship Description (section R). The identifying numbers are assigned arbitrarily in no particular pattern.

**(A3.214)** While the counters included with the game will be adequate for most of the scenarios in the game, players who are devising their own scenarios may wish to have more of some particular type. There is nothing wrong with using a counter for something that it was not specifically intended to be, so long as this is made known to your opponent prior to the start of play. For example, if you wished to have five Federation heavy cruisers in a given scenario, you might use two command cruisers to "fill in," telling your opponent of the substitution. Alternatively, if you wished to have 12 Klingon D7 cruisers in a given scenario, you might use the three D7s that come with the game, then use the three D6s, the three Romulan KRrs, and three Kzinti strike cruisers. So long as the usage is consistent and known to the opponent, any substitution of counters is acceptable. Note, however, that it would be confusing to have both players using counters from the same race/nation. Additional counters are available; see (Z6.1).

**(A3.22) THE MAPSHEET (PLAYING BOARD)**

**(A3.221)** The map used in *STAR FLEET BATTLES* is overlaid with a hex grid, used to regularize the position of each ship and its distance to other ships.

Players may, if they wish, obtain a larger hex grid or additional maps (Z6.1) to expand the field of play if they are using large fleets, but the map included with the game should be adequate for all scenarios. (Some players cut the map into six sections so that, if their battles tend to drift one direction or the other, the map can be "leapfrogged" in front of the action. Do not do this unless you are certain that you want to.)

If you obtain a mapsheet somewhere else, check to see how it is numbered. On the standard *STAR FLEET BATTLES* maps, the odd-numbered columns are "above" the even-numbered ones. On some other maps this is the reverse, having the effect of shifting all units in odd-numbered columns "down" one hex, creating some amusing problems.

Alternatively, if one unit moves off the map, all ships can be shifted enough hexes to one side to correct the situation (S1.43).

**(A3.222)** Players should note the two directional displays on the map. One is composed of numbers, the other of letters. These are used to determine direction. Players should refer to the movement rules (C1.21) for explanation of the use of these displays.

**(A3.23) UNIT CATEGORIES:** The terms "ship" and "unit" are critical to the way the *STAR FLEET BATTLES* rules are written. All ships are units, but not all units are ships.

The most basic category is a COUNTER or playing piece. There are two types of these: units and markers.

A MARKER is an informational item. Markers include planets, asteroids, and (in later products) such things as explosions, wild unit markers, cloak markers, and so forth.

A UNIT is a something that actually does something. All are either machines (ships, bases, fighters, etc.) or living beings (monsters). Units include ships, shuttles, seeking weapons, mines, and monsters.

SEEKING WEAPONS include drones, plasma torpedoes, and seeking shuttles. See (F0.0). Seeking shuttles are seeking weapons in some regards and shuttles in others. Some drones are self-guiding, while all plasma torpedoes are.

SHUTTLES include fighters and non-fighter shuttles. Non-fighter shuttles include Administrative Shuttles and (in later products) other types.

SHIPS include PFs (fast patrol ships, see Module K) and bases, unless stated otherwise. PFs includes the sub-category of Interceptors (K3.0). Bases include those with positional stabilizers (all of those in Basic Set have them) and those without.

UNIT													
Monster	Seeking Weapon			Shuttle				Ship				Mine	
Monster	SGSW	Non-SG	Seeking Shuttle	Non-Ftr		Fighter		PF	Ship (except)	Base		Mine	
Monster	Plasma	Drone	SP SS	Adm	Other	Std Ftrs	Heavy Ftrs	INT	PF	Ship (except)	with Stab	without Stab	Mine

SGSW = Self-guiding seeking weapon; SP = Scatter-Pack; SS = Suicide Shuttle; INT = Interceptor; PF = Fast Patrol Ship.  
The exceptions under ships refer to cases where the terms "ships but not bases" or "ships not including PFs" are used.

**(A3.3) BACKGROUND**

As can be seen from the map (below), the races portrayed in the game occupy a rather small area on the edge of the galaxy. Background material for the individual races is included in section R. More races are added to the game by Modules C1, C2 (and eventually C3).

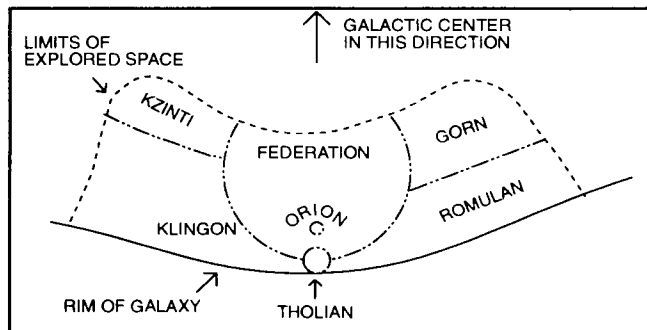

The chronology below describes the major events of the game universe.

YEAR	EVENT
1	First contact between the Human race and their nearest neighbors (Orions, Vulcans, etc.).
4	Formation of the Federation.
40-46	The first Romulan War (between Federation and Romulan Star Empire).
45	Introduction of the cruiser design by the Federation.
46	The Romulan-Federation ceasefire.
50-82	First Klingo-Kzinti War.
62	Federation begins conversion of cruisers to warp power.
62-67	All races (except the Romulans) develop warp-powered ships.

- 71..... Federation Star Fleet is formed, member races begin disbanding their "national" fleets in favor of the unified fleet.
- 79..... Tholians arrived and occupied an area claimed by the Klingons.
- 82..... Klingons win First Klingo-Kzinti War, depriving Kzintis of three key colony planets.
- 83..... Klingons encountered the newly arrived Tholians and began the first of several wars in their continuing attempt to destroy them.
- 103-106..... Second Klingo-Kzinti War is won by the Kzintis, regaining the three planets.
- 110-111..... First war between the Federation and Klingon Empire. The war is bitter, but inconclusive.
- 113 ..... The Federation completes the disbanding of the "national" fleets in favor of the unified Star Fleet. Sixteen Orion starships (of various types) with almost 9,000 skilled crewmen mutiny and disappear. They form the nucleus of the Orion Pirates.
- 123-131..... Third Klingo-Kzinti War. Inconclusive results.
- 150-170..... Primary time frame of the ships in Basic Set and of the original film background.
- 154-155..... Second Romulan War (between Romulan Empire and Federation) results in a treaty of the Neutral Zone.
- 156..... Second War between Federation and Klingon Empire ends in the Organian Treaty.
- 157..... Initial confrontation between the Gorns and the Federation ends in Treaty of Friendship.
- 158-162..... Fourth Klingo-Kzinti War. Results inconclusive.
- 159..... Klingon-Romulan Treaty of Friendship is signed. Klingons begin supplying advanced technology to Romulans, resulting in greater pressure on Federation border. Federation transfers main fleet units from Klingon border to Romulan border, releasing Klingon ships to fight Kzintis.



- 160.....First KR's and K5R's delivered to Romulans.
- 161.....Kzintis introduce Attack Shuttle. This early fighter cannot guide its own drones and is considered only a manned drone launch platform.
- 162.....Romulans begin conversion of Warbirds to War Eagles.
- 164.....Kzintis deployed the Advanced Attack Shuttle, which was able to guide its own drones. The concept of dedicated fighter carriers (rather than simply adding a couple of fighters to standard warships) began.
- 165.....Kzintis launch the first of a class of shuttle carriers.
- 166.....Federation-Kzinti Articles of Agreement.
- 168.....All races begin introducing new ship classes and preparing for the coming war.
- 168-185.....The First General War. All of the races in Basic Set (and several in Module C1) are involved in a very destructive war that covers most of the known regions of the galaxy.
- 186-187.....The ISC (in Module C2) attempt to save the warring galaxy from itself by occupying most of it.
- 188.....The Andromedans (Module C2) invade the galaxy.
- 202.....After a long campaign, the Andromedans are defeated.

Some locally operated campaign games are set within certain time periods, limiting the ships and technology available.

**(A3.4) GAME SCALE**

Each hex in *STAR FLEET BATTLES* represents an area 10,000 kilometers across. Movement at a speed of one hex per turn equals movement at the speed of light. Thus, each turn represents 1/30 of a second of subjective time. However, using relativistic variable time distortion, the time elapsed during a turn appears to the crew inside the ship to be about a minute.

**(A3.5) FRACTIONS**

Many of the calculations in the game will produce fractions. If not otherwise stated, drop fractions of 0.499 or less; round fractions of 0.500 or more to the next higher number.

**(A4.0) THE CADET'S GAME**

Players unfamiliar with *STAR FLEET BATTLES* should begin by playing the "Cadet's Game." (This is sometimes known as the "beginner's game.") This involves only certain rules sections (less than 10% of this rulebook) which are not otherwise marked. Reading them will allow you to play, within an hour or two of opening this volume, a battle between a Federation heavy cruiser and a Klingon D7 battlecruiser. Once you have played that scenario (perhaps two or three times), you will, no doubt, be anxious to read and master the remainder of the rules.

**(A4.1) FIRST CADET SCENARIO:  
COMBAT WITH PHASERS**

Read the following rules:

- (B2.1), (B2.3), (B3.0),
- (C1.1), (C1.2), (C1.31), (C1.4), (C2.0), (C3.0),
- (D1.0)-(D1.4), (D2.0), (D3.0) except (D3.5)-(D3.6), (D4.0),
- (E1.0), (E2.0),
- (H1.0) through (H6.0)
- (R2.4), (R3.4),
- (S1.0), and (SG1.0).

Read the indicated sections and play scenario (SG1.0) NOW, before going on to read any other sections. Then play the Second Cadet Scenario (A4.2).

You will be using phasers only for this scenario. Without the heavier photons and disruptors it will be all but impossible to destroy the enemy, but the point is to learn the concepts of maneuver and the mechanics of firing weapons.

Anything on the SSD sheet which is not within these rules can be ignored. If your opponent destroys it, assume that you weren't planning to use it anyway so it's not important.

Play this scenario only once, and stop after 5 or 6 turns. By that time, you will be ready for more advanced combat.

For all of the Cadet Scenarios, assume that this is a "peacetime" patrol encounter and that either ship can "concede" at any point. The ship that concedes will then leave the area and the other ship is the victor.

**(A4.2) SECOND CADET SCENARIO:  
COMBAT WITH HEAVY WEAPONS**

Read rule sections (E4.0), (E4.1), and (E4.2) regarding photon torpedoes. If you aren't sure you understand them completely, play a battle (SG1.0) between two Federation CAs to get a feel for arming and firing the photons.

Then read rule sections (E3.0), (E3.1), (E3.2), and (E3.3) regarding Klingon disruptors. If you aren't sure you understand them completely, play a battle (SG1.0) between two Klingon D7s to get a feel for arming and firing these weapons.

You are now ready for the basic duel of *STAR FLEET BATTLES* between a Federation CA and a Klingon D7. Read the description of such a battle in (A5.0) and then try it for yourself. The battle in (A5.0) uses the Cadet (A4.2) rules plus the rules for overloaded weapons. This was done because overload range (8 hexes) is a key tactical consideration.

**(A4.3) THIRD CADET SCENARIO:  
COMBAT WITH SEEKING WEAPONS**

Read the following rule sections on drones:

- (F1.1), (F1.21), (F2.11), (F2.12), (F2.2), (F2.3), (F3.1),
- (FD1.1) through (FD1.4),
- (FD1.51) through (FD1.55) [skip (FD1.53)], (FD1.6),
- (FD3.1), (FD4.1), (FD4.2), (FD5.3).

Ignore (FD2.0). The two drone racks on the Klingon D7 each hold 4 drones and can launch one per turn. They cannot launch a drone within 8 impulses of a drone launched by the same rack on the previous turn. Each drone is speed 20, takes 4 damage points to destroy, and does 12 points of damage to the ship if it hits it.

Then play scenario (SG1.0) again, this time allowing the D7 to use its drones. After playing this a few times, you can read rule sections (FD1.56) [but not (FD1.561)] and (F2.5) and allow the Federation CA to use the one drone rack provided in its refit (see the SSD).

When you are familiar with drones, read the following:

- (FP1.1) through (FP1.6),
- (FP2.3) and (FP2.5),
- (FP3.1), (FP4.1), and (FP4.2).

Then play scenario (SG1.0) again using a Gorn CA (without the refits) against either the Federation CA or the Klingon D7. (Play at least once with each.)

**(A4.4) ASSUME COMMAND!**

AFTER reaching this point, return to the rules and read those sections that immediately capture your interest. Some suggestions include:

- Overloaded weapons (E3.5) and (E4.4).
- Cloaking Devices (G13.0).
- Other ships: Romulan KR (R4.4), Kzinti CS (R5.2).

After playing another scenario or two, stop and read all rules that are NOT marked as Advanced, Optional, or Commander's Level. These other rules can be added later, after you have mastered the Standard Rules.

**(A5.0) SAMPLE GAME**

New players may feel overwhelmed by the mass and seeming complexity of the rules. Rest assured that the extensive rules are provided because players who have learned the game want to explore every aspect of starship operations, and those who are terrified at this point will shortly be reaching for more and more rules as they take their starships into uncharted territory. For now, however, the problem is to actually begin playing and to begin learning just what all of these rules are for. [NOTE: Read section (A4.0) and the rules designated in it at this time.] We shall observe Bill and his friend Jane as they play scenario (SG1.0).

Bill, commanding the Federation CA, notes that he is 44 hexes from the Klingon D7 commanded by Jane. He has 34 units of power available (30 warp engine, 4 impulse engine, no reactors) and his 4 batteries are full. He must now allocate this power. At such a long range, the first decision must relate to movement, because if he wants to move much closer to the D7, it will take a lot of power. However, he does not wish to close the range during this turn because his photon torpedoes (which take two turns to arm) cannot be ready until Turn #2.

Therefore he allocates his 34 points as follows: 1 to life support, 1 to fire control (both required), 6 to phasers (he knows he will not be able to fire them all, but wants to store the energy in the capacitors for next turn), 8 to photons (2 points to each of the four), 2 to activate the shields, 12 to reinforce the #1 shield (to discourage long-range Klingon sniping), and 4 to movement. He knows that even if the Klingon moves at a speed of 31, his ship can avoid the 8-hex range of overloaded disruptors.

Jane is aware of the arming rate for photon torpedoes and guesses that Bill will not move very quickly. She wants to be able to score at least some damage. She has 39 units of power (30 warp, 5 impulse, 4 reactor) to allocate and does so as follows: 1 to life support, 1 to fire control, 7 to phasers (less than the maximum of 9, but she plans to run straight in and won't need the right side phasers, and wants to maximize power output on this turn), 8 to disruptors (non-overloads), 2 to raise the shields, 6 to reinforce the front shield, 2 to reinforce the #6 shield, and 12 to move. Her batteries remain fully charged.

When speed is announced, both players immediately realize that the other is playing a fairly standard strategy. For our purposes, both will move straight ahead, and since the chances of a hit are continually improving, neither will fire until the last impulse. At that point, the D7 has moved 12 hexes and is in 3009. The CA has moved 4 hexes and is in 1128. The range is 28 hexes. The Klingon ship fires disruptors (die rolls 1-2-4-5, two hits, total 4 damage points) and the four facing phasers (die rolls 2-3-4-6, one hit, total 1 damage point) for 5 damage points. This reduces the Federation ship's reinforcement, but since that energy is expended and reallocated each turn, the tactical result is meaningless. (Indeed, Jane wasted the four points of phaser energy.) The Federation ship does not fire, saving its phaser energy.

On Turn #2, the tactical advantage shifts to the Federation, as its photon torpedoes will now be armed. Since the ships are still 28 hexes apart, and must close to 8 hexes or less to use overloaded weapons, both players must make a critical choice about their speed. The Federation ship, which must use warp energy for its photons, can move at a maximum speed of 23 while charging photons, or at a lower maximum speed if overloading them. Jane, who knows the rules and how to subtract, is aware of this fact. While her D7 does not need warp energy for disruptors, the demand for overload energy (16 points) will inevitably use much of her warp power. Paradoxically, if both overload their weapons to the maximum extent, it is possible that they will not be within the maximum range of overloaded weapons!

Bill decides to overload his weapons, while Jane decides to leave her weapons on standard settings.

Bill's energy allocation: 1 to life support, 1 to fire control, 0 to phasers (all are still charged), 16 to photons (2 to torpedoes 1 & 2, standard loads, and 6 each to 3 & 4, full overloads of 8 points each counting the 2 points on the previous turn), 2 to raise shields, 0 to reinforcement (a risky choice since any damage will mark off boxes), and 14 to movement.

Jane's energy allocation: 1 to life support, 1 to fire control, 6 to phasers (3 points are left in the capacitors from last turn), 8 to disruptors, 2 to raise shields, 7 to reinforce shield #1, 2 to reinforce shield #6, and 12 to move.

Bill does some quick arithmetic. With combined speeds of 26 and a starting range of 28, the two ships will come within range of his overloaded photons. Jane reaches the same conclusion. Bill determines to close the range.

The two ships then begin moving. Both move on Impulse #3. The D7 turns right (having fulfilled its turn mode on the prior turn). This is not a retreat but a plan to keep the range open. On Impulse #11, the D7 (in 2708) turns to move to 2608. The CA is in 1625. By Impulse #19, the D7 (in 2409) turns to 2410. The CA is now in 1924. At the critical Impulse #25 (critical because weapons fired after that point cannot be fired on Impulse #1 of the next turn; this is known to SFB veterans as the Impulse of Decision), the CA is in 2123 and the D7 is in 2412. The CA fires its two left phasers (die rolls 3-4, one damage point absorbed by reinforcement) because he plans to turn and these phasers will no longer have a target. On Impulse #30 the ships are in 2120 and 2414, a range of only 7. Both players know that they will not reach a range of 4, and their heavy weapons will be no more effective at range 5 than range 7 (or 8 for that matter), so both fire. (Bill should have realized that while his photons would be no more effective at range 5 than range 8, his phasers would have been devastating at range 5. Perhaps Bill was afraid that Jane would turn away if he did not fire soon?)

Bill fires two standard photons (2-5, one hits, 8 damage points), two overloaded photons (1-3, both hit, 32 damage points), and 4 phaser-1s (2-3-4-6, total 8 damage points) for a total of 48 damage points. These penetrate the shield and its reinforcement, scoring 11 points of internal damage, 2 of which destroy warp engine boxes.

Jane fires 4 disruptors (1-2-4-6, 3 hits, 9 damage points) and 4 phaser-2s (1-2-3-4, total 7 damage points) for 16 damage points, destroying more than half of the CA's front shield.

On the final impulse, the CA moves to 2119, while the D7 turns to 2315, firing its three remaining phasers (1-2-3, 6 damage points), reducing the front shield to only 8 boxes.

The third turn becomes critical. The Federation ship cannot arm photons in one turn and has a choice of standing still (using the energy to reinforce the shields) or trying to run. The Klingon will be able to fire overloaded disruptors on Impulse #6.

Bill's allocation: 1 to life support, 1 to fire control, 6 to phasers, 8 to photons, 2 to raise shields, 20 points (including batteries) to reinforce the front shield, no movement.

Jane's allocation: 1 to life support, 1 to fire control, 6 to phasers, 16 to disruptors (overloads), 10 (including two of the batteries) to general reinforcement (because she cannot reinforce shield #1, which is down), 5 to movement. (The other two points were lost in the damage received.)

On Impulse #6 (when both can fire), neither ship has moved. The CA fires four of its phasers at the D7 (1-2-4-6, total 11 damage, which removes the general reinforcement and scores 6 points on shield #6). On Impulse #13, the D7 has reached 2116. It fires four disruptors (2-2-3-5, three hit, total 24 points damage) and six phaser-2s (1-2-3-4-5-6, 21 points damage) for a total of 45 points, enough to destroy the reinforcement (20), knock down the shield (8), and score 17 points of internal damage. Bill fires his remaining two phasers (which just came into firing arc) and rolls a 3 and a 4 for 8 points of damage on the D7's #6 shield. The D7 continues to 2018. At this point-blank range, the two ships will savage each other with overloaded weapons on the next turn. The players are left to work this out for themselves.

Both Bill and Jane are obviously novice players as their tactics consist of little more than closing and firing. Bill's decision to bring his ship to a complete stop gave Jane the tactical initiative, but she was unable to capitalize on it.

If you still do not understand the game, see (Z3.0).



**END OF SECTION (A0.0) BASIC SET**

# (B0.0) HOW TO PLAY THE GAME

## (B1.0) GENERAL RULES

This section details the Sequence of Play (the exact order in which the actions of the game take place) and the rules for Energy Allocation.

## (B2.0) SEQUENCE OF PLAY

### (B2.1) GENERAL

*STAR FLEET BATTLES* is played in turns, of which there may be almost any number in a given scenario. Each turn consists of several phases, some of which are broken down into several segments and/or impulses. Each turn consists of several steps (primarily planning and the launching of some weapons types) followed by a number of impulses during which movement and combat take place.

### (B2.2) OUTLINE OF THE SEQUENCE OF PLAY

1. ENERGY ALLOCATION PHASE
2. SPEED DETERMINATION PHASE
3. SELF-DESTRUCTION PHASE
4. SENSOR LOCK-ON PHASE
5. INITIAL ACTIVITY PHASE
6. IMPULSE PROCEDURE
  - A. MOVEMENT SEGMENT
  - B. IMPULSE ACTIVITY SEGMENT
  - C. DOGFIGHT RESOLUTION INTERFACE
  - D. DIRECT-FIRE WEAPONS SEGMENT
  - E. POST-COMBAT SEGMENT
7. FINAL ACTIVITY PHASE
8. RECORD KEEPING PHASE

### (B2.3) SEQUENCE OF PLAY EXPLANATION

This section describes the basic operation of the Sequence of Play and the turn procedure. Note that a more detailed listing of all actions that can be taken during the Sequence of Play, in the specific order in which they occur, is given in Annex #2.

**1. ENERGY ALLOCATION PHASE:** Each player, for each ship that he controls, fills out the next available column on the Energy Allocation Form for that ship. Refer to the Energy Allocation Rules (B3.0). It is by the allocation of energy that players determine, in this phase, what the speed of their ships will be during the current turn and what equipment and weapons may be operated.

**2. SPEED DETERMINATION PHASE:** The speeds for all ships (as well as drones, shuttles, plasma torpedoes, and any other moving objects) are announced or determined. During this phase, the controller (C1.44) prepares his control sheet.

**3. SELF-DESTRUCTION PHASE:** Ships that are plotted to self-destruct do so at this time, and the effects of the blast are applied immediately to any ships within range of the blast. Refer to rule (D5.0).

**4. SENSOR LOCK-ON PHASE:** All ships (and other units) which wish to fire at enemy units during the current turn, or which are controlling seeking weapons on the map targeted on other units, MUST attempt to achieve a sensor lock-on at this time. Refer to rule (D6.1). This is resolved with a single die roll for each ship attempting lock-on for all of that ship's potential targets. The effects of the lock-on or failure to lock-on will last for the entire turn. A given unit will either have a lock-on to every other unit on the map, or to none of them. Note that in the case of ships that have not suffered sensor damage, lock-on is automatic. Some effects such as electronic

warfare (D6.3) or planets (P2.0) could block or reduce the quality of a lock-on. Note that in some advanced rules your fire control may be in an inactive state, leaving you without any lock-ons.

**5. INITIAL ACTIVITY PHASE:** During this phase, players take certain actions, such as tractor rotations, undocking from bases, variable pulsars, assigning guards, etc. See Annex #2.

**6. IMPULSE PROCEDURE:** The movement/combat portion of the turn is divided into 32 impulses. The following steps are repeated in each of those 32 impulses.

**A. MOVEMENT SEGMENT:** The ships that will move in the current impulse are determined by the controller from the movement chart (see separate sheet). This information is announced to all players. Each player whose unit is to move in this impulse moves it one hex within the limits of the ship's turn mode [or in accordance with his pre-plotted movement (C1.32)]. Note that "seeking" weapons have special rules for movement (F2.2). Also note that the impact of seeking weapons is determined, and any resulting damage resolved, at the end of the Movement Segment.

**B. ACTIVITY SEGMENT:** This segment is used for activities that take place during the Impulse Procedure, such as transporter operations, laying mines, launching shuttles or seeking weapons, recovering shuttles, or other activities specified by the rules. These activities take place in a specific order shown in Annex #2. This data is shown in an Annex so that it can be replaced and updated in advanced products.

**C. DOGFIGHT RESOLUTION INTERFACE:** This special section, dealing with fighters, happens only in certain impulses. For more information see Module J.

**D. DIRECT-FIRE WEAPONS SEGMENT:** Players determine for each of their units if it will fire any of its weapons during this impulse. This is done secretly and simultaneously; see (B2.4). Players then simultaneously announce for each of their units if they will fire, and if so, which weapons and at which targets. [All players must indicate that they have made their decisions (on weapons and EW changes) before any announcements are made. Once announcements begin, the decisions cannot be changed. In a complex or hard-fought game, players might give their detailed firing orders to a non-playing referee.] Weapons are then fired in any convenient order in accordance with the rules on combat (D0.0). Damage is assumed to be simultaneous, i.e., a weapon committed to fire may still fire if it is destroyed by a weapon firing in the same segment of the same impulse.

**E. POST-COMBAT SEGMENT:** Certain decisions and announcements, detailed in Annex #2, are done at this time.

The Impulse Procedure is repeated for each impulse of the current turn. When all 32 impulses are completed, return to the Sequence of Play and proceed with the Final Activity Phase.

**7. FINAL ACTIVITY PHASE:** See Annex #2 for details of actions and announcements made at this time.

**8. RECORD KEEPING PHASE:** See Annex #2 for a detailed list of the actions and announcements made at this point.

After completion of all activities of a given turn, the turn is complete and the next turn is begun. The Sequence of Play is repeated for each turn until the scenario is over. Various events (such as the arrival of additional units) may take place in specific turns.

**NOTE:** The expanded Sequence of Play listing in Annex #2 has been carefully written to show the EXACT and SPECIFIC order in which the actions of a turn or impulse are to be taken. Careful study of this listing will answer many questions about the rules. The order is specifically intended to prevent (or allow) certain actions from happening on the same impulse.

**(B2.4) SIMULTANEOUS ANNOUNCEMENTS:  
PROCEDURES AND POLICIES**

At several points in the Sequence of Play, players will be required to make "secret and simultaneous" allocations of resources or commitments to take certain actions. The most obvious is the use of direct-fire weapons in step 6D above, but many others (launching drones, using transporters, etc.) exist and will become obvious as players become familiar with the game.

The problem with "secret and simultaneous" is that it requires written records, and these can become a tiresome chore when trying to play a game for relaxation and entertainment. Many players do not bother with written records, but simply make their decisions in their heads and then make the announcement simultaneously. The problem is that it doesn't turn out to be simultaneous.

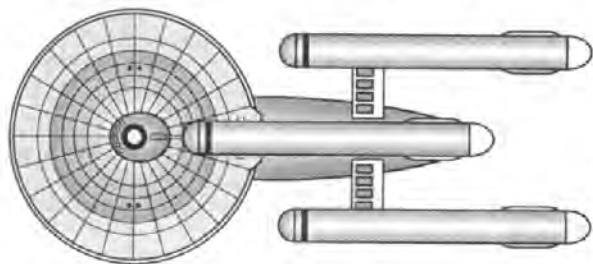

FEDERATION DREADNOUGHT

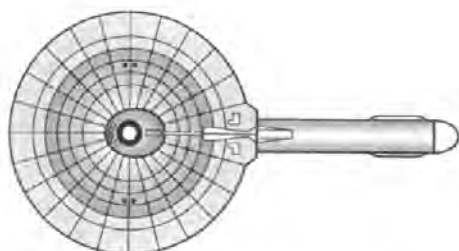

FEDERATION DESTROYER

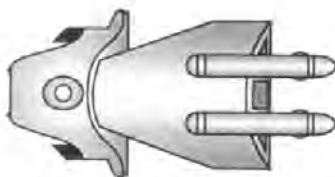

FEDERATION OLD-TYPE LIGHT CRUISER

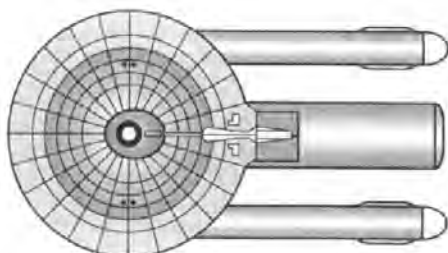

FEDERATION FLEET TUG

Imagine, if you will, two ships heading straight toward each other. Their weapons become more effective as the range closes. If they both fire at the same time, they will both take the appropriate damage. If one player fires earlier, however, he will be gambling on less effective weapons penetrating the enemy shield and destroying some enemy weapons before those weapons can fire on the next impulse (or a later one). It isn't difficult to see that whoever makes a non-written announcement first is placing his life in the enemy's hands, as that enemy can then decide to fire simultaneously (claiming he had intended to do so anyway) or decide to withhold fire, take his chances, and smash his opponent with close-range fire a few impulses later. This phenomenon is known as "me too firing" and, while often used in a friendly game, can cause hard feelings in a fiercely competitive tournament or campaign. This does not mean that SFB players are inherently dishonest; it is simply human nature to make each decision with whatever information is on hand at the time. Some players report that they experience more tension from the temptation to change their decisions than anything else in the game.

Some players seek a middle ground, asking each other only if they will fire and then writing down the orders. Sometimes, a coin or die hidden behind the hand, or a card marked "fire" on one side and "no fire" on the other and covered by one's hand, can be used instead of a verbal announcement.

While this avoids having to write down fire orders (or dummy fire orders) 32 times per turn, it can also reveal more information than is good for your career. In the case above, one player might announce firing (without revealing that he plans to fire a ph-3 on the rear of his ship toward a drone) in an attempt to get the opponent to panic and fire everything before optimum range.

Probably the best solution is provided in Captain's Module A: *BattleCards!*, i.e., the two sets of Command Cards found in that product). Each player holds his set of cards and simply lays down one or more of them each impulse, exposing them to indicate what (if any) weapons he has decided to fire. Players who do not have Module A can easily create such a system for themselves with a few index cards.

Whatever system you use, it probably will not be necessary to go through the motions on all 32 impulses of every game. During some times, the ships will be far apart but moving together and it will be obvious that no one wants to fire at such a long range. At other times, both players will have fired every weapon they own and agree to simply play out the rest of the turn without bothering with pointless fire declaration steps. While this informal system speeds the game (and makes it far less tedious), players should keep a careful eye on the situation and announce well in advance that "I am going to want a fire decision step on this impulse." This will avoid hurt feelings if Player A feels he missed a chance to fire while Player B (who already moved for Impulse #22 because Player A did not say quickly enough that he wanted to fire on Impulse #21) wonders if Player A wouldn't want to fire if Player A did not already know where Player B would have moved to if Player A had not fired. (Did you understand all that? Good! Write us a letter and explain it to us.)

It is only human nature to look out for your own interests. When playing competitive games, or with new opponents, take every precaution to avoid hurrying or delaying your opponent into (or out of) a decision. Simple politeness ("You seem to be mulling this over, Fred. Are you trying to make up your mind or wondering why I am taking so long to call the next impulse?") will usually overcome any confusion.

Above all else, remember that this is a game that you are trying to enjoy, not a competition that will determine the course of your life. Fair play and reasonableness should prevail. If you learn nothing else from *STAR FLEET BATTLES*, at least try to learn how to get along politely and fairly with people who are trying their damndest to kill you.

**(B3.0) ENERGY ALLOCATION**

The heart of the game is in the energy allocation rules. Here players must determine how much power (energy) is available and how to use it most wisely. You will never have as much power as you have uses for it.

**(B3.1) PROCEDURE**

Energy is calculated and allocated on an Energy Allocation Form. There are several of these included with the game. Players should use plastic page protectors and grease pencils or photocopy extra copies of this form for use in the game. Packages with extra copies of the EAF are available for sale in some hobby stores. Each turn during the Energy Allocation Phase, each player, for every starship he controls, must fill out the next column of his EAF.

Special Energy Allocation Forms for use by specialized units are provided in Module R1. The Andromedans in Module C2 have their own special Energy Allocation Form. Specific instructions for filling out the form are given on a line by line basis, as follows:

**1. WARP ENGINES:** This is the amount of warp engine power available. Simply count the unchecked warp engine boxes on the ship's SSD. For example, the Federation cruiser starts with 30, the Kzinti strike cruiser with 27, and the Gorn heavy cruiser with 32. This number may be reduced by damage. See (H2.0) and (G15.2).

**2. IMPULSE POWER:** This is the amount of power available from the impulse engines (H3.0). Again, simply count the number of unchecked boxes. (The Federation heavy cruiser has four.)

**3. REACTOR POWER:** This is the amount of power from nuclear reactors (H4.0). The Klingon D6 battlecruiser has two reactor boxes on its SSD. The Federation command cruiser also has two, but the Federation heavy cruiser has none (although two are added with a later refit).

**4. TOTAL POWER:** This is the total amount of power available from all sources other than batteries. At the start of a scenario, an undamaged (and unrefitted) Federation heavy cruiser will have 34 units of power, a Federation command cruiser 36, a Klingon D6 battlecruiser 37, and a Gorn heavy cruiser 38. Assuming that the ship has not been damaged, line 4 will have the same number each turn.

**5. BATTERIES AVAILABLE:** This is the amount of battery power (H5.0) available for use. Note the value of leaving some or all of these batteries unused as detailed in (H7.0). The effective use of reserve power is one of the most important skills to master if you plan on winning your battles.

**6. BATTERIES DISCHARGED:** This is the number of batteries that have previously been used. The total of 5 and 6 will always equal the number of undestroyed battery boxes on the SSD (or their capacity in some advanced cases). At the beginning of a scenario, the batteries will all be charged. Careful players save their batteries until the ship is heavily damaged and use them to fill in, temporarily, for destroyed engines. Skillful players, however, use their batteries constantly for that one additional unit of power that can be critical. Batteries destroyed in combat are presumed to have been those previously discharged, if any such batteries exist.

**7. LIFE SUPPORT:** You MUST allocate energy to life support or your entire crew will perish immediately. The life support cost for a ship depends on its size class. The size class of each ship is shown on the MASTER SHIP CHART and on each SSD; the life support cost for each size class is shown on the chart below (B3.3). Note that if a ship is crippled (S2.4) it can use emergency life support, which costs no power. Legendary Captains (G22.2) can also use emergency life support. If a ship is being boarded and no one has control for EA purposes, the ship operates under Emergency Life Support. It is specifically not possible to turn off life support (to a specific area, or to the entire ship) to cause enemy crew units to die, even if you are sacrificing your own crew units in the process.

**8. ACTIVE FIRE CONTROL:** One unit of power will operate the scanners and sensors for the current turn; see (D6.6). A half unit of power will provide Low-Powered Fire Control (D6.7), but this is severely restricted. If no power is allocated to this line, you cannot have a lock-on and weapons MAY NOT BE FIRED. [Passive Fire Control (D19.0) in Advanced Missions might allow firing in some cases.] Seeking weapons may lose their tracking and be removed, see (FD5.0).

**9. PHASERS:** Energy for phasers is explained in the rules on phaser capacitors (H6.0).

**10. TORPEDOES:** This line is used for photon torpedoes, plasma torpedoes, disruptor bolts, and other heavy weapons. The allocation of energy for each launching tube (system box) is recorded separately on one line here. The specific method of allocation for each weapon type is covered within the rules on that weapon type.

**11. SHIELDS:** Shields may be operated at "minimum" or "full" power. The cost for each depends on the size class of the ship, as is shown on the chart in (D3.32).

**12. GENERAL SHIELD REINFORCEMENT:** Any amount of available power may be applied here; see (D3.341).

**13. REINFORCE SHIELDS:** Energy may be added directly to one or more specific shields. For more information on reinforcement, see (D3.342).

**14. MOVEMENT:** Energy is required to move the ship. This energy can come from either warp (H2.0) or impulse (H3.0) engines. No more than one unit of power can come from impulse engines; see (C2.111). Warp engine energy provides movement at a rate specified for each ship. Basically, the amount of warp engine energy allocated is divided by the movement cost for that ship to yield the number of movement points provided. For example, the Gorn CA has a movement cost of 1, so 17 points of warp engine energy will provide 17 movement points. The Federation DN has a movement cost of 1+1/2, so 18 points of warp engine energy will provide 12 movement points. The Klingon F5 has a movement cost of 1/2, so 13 points of warp engine energy will provide 26 movement points. No more than 30 movement points can be provided by warp engines; see (C2.112).

**15. DAMAGE CONTROL:** This line is used to allocate energy for damage control; (D9.2) and (D14.0).

**16. RECHARGE BATTERIES:** Energy allocated on this line will recharge previously discharged batteries. See the rules on batteries (H5.0) and (H7.0).

**17. TRACTOR AND NEGATIVE TRACTOR BEAM:** Energy allocated here is used to tractor various objects or to prevent the ship from being tractored. See (G7.0) for details.

**18. TRANSPORTERS:** Power allocated here is used to operate the ship's transporters. See (G8.0) for details.

**19.** Several lines are provided to allocate energy to miscellaneous systems not specifically listed above. Examples of these would include electronic warfare, cloaking devices, or shuttles.

**20. TOTAL POWER USED:** This line is used as a final mathematical check to make sure that you have allocated the correct amount of power. It also serves to determine if you have discharged any batteries.

**21. BATTERY POWER USED:** This is a record of the number of batteries that were discharged on the current turn. It is used to adjust lines 5 and 6 on the next turn.

**NOTE:** Except when specifically stated to do so, energy does NOT "carry over" from turn to turn.

**EXAMPLE:** If power was allocated to movement on a given turn, this power could not be used to move the ship on a later turn. If 7 units of power were allocated to a ship on Turn #5 and none on Turn #6, it would move 7 hexes on Turn #5 and would not move at all on

Turn #6. If energy was allocated to transporters on Turn #5, and not used, this power is lost and cannot be used to operate the transporters on any later turn. ONLY in the case of phasers [detailed in (H6.0)], batteries, multi-turn-arming weapons, and armed weapons being held is power carried over from one turn to a later turn. In some cases (e.g., photon torpedoes), energy must be expended over a period of two or more turns. The energy expended on each of those turns comes from power generated during each specific turn.

**(B3.2) FRACTIONAL ACCOUNTING (Advanced)**

Players willing to accept the increased workload may elect to retain all fractions when calculating energy requirements.

This rule is described in the Tactics Manual as one of two optional rules (the other is C12 in Advanced Missions) which will usually mean victory when used by one player against a player who refuses to bother with them.

**(B3.21) FRACTIONS:** Fractions of energy points used for various systems may be combined. For example, a Klingon C8 dreadnought uses 1-1/2 energy points to move one hex and uses 1/2 of an energy point to fire a phaser-3. Therefore, two energy points ( $1-1/2 + 1/2 = 2$ ) would be needed to perform these two functions, but without the fractional accounting system, three points would be required since all energy expenditures are rounded up.

**(B3.22) STORAGE:** All unused fractions of an energy point can be stored in batteries; otherwise they are lost. The fractions are subject to the normal storage limits; a battery can hold less but not more than one point of energy (with the exception of certain ships in other products). Thus, a battery could hold 2/3 of an energy point but not 1-1/3.

**(B3.3) LIFE SUPPORT COST CHART**

The amount of life support required by a given ship depends on its size, as shown on the chart below:

SIZE CLASS	LIFE SUPPORT ENERGY COST
1	3
2	1-1/2
3	1
4	1/2
5	0

**(B3.4) NON-EXPENDITURE**

A player is never required to expend all of the power his unit generates. Some expenditures are required (e.g., without life support the crew will die), and some are required by certain functions (e.g., you cannot control drones without active fire control). It is possible that mandatory or required functions could consume all available power.

If a unit leaves part of its power output unallocated, it is simply assumed that the engine/reactor was operated at a lower power output and the unallocated energy was never created. This unallocated energy cannot be used for reserve power. A player would be better off to allocate it under (H7.4).

**END OF SECTION (B0.0) BASIC SET**

**(C0.0) MOVEMENT****(C1.0) GENERAL MOVEMENT RULES**

Starships and other units move on the map by a combination of impulse engine power and warp engine power. The speed of most units in the game varies from turn to turn, depending on the amount of power which is allocated on any given turn for movement. Each hex moved into during the course of a given turn equals one times the speed of light. (Moving 10 hexes during a given turn is equal to moving 10 times the speed of light on that turn.)

Players in this game determine the speed of their own ships during the Energy Allocation Phase by the amount of energy allocated to movement. (Certain other units such as shuttles and seeking weapons move at speeds defined in the rules.) The amount of energy allocated is limited by the rules (which restrict speed to a maximum of 31 for ships and shuttles, 32 for some other units), damage taken by the ship in previous turns (which may reduce power available), the restrictions on acceleration, and tactical considerations. (It may not be necessary or desirable to move completely across the map, and the power may be needed for other things, such as shields and weapons.)

Players may be more familiar with the term "warp factors." The speed of the unit (in multiples of c, the speed of light) is the cube of the warp factor. Thus, warp 2 is  $(2 \times 2 \times 2 =) 8$  hexes per turn, and warp 3 is  $(3 \times 3 \times 3 =) 27$  hexes per turn.

**(C1.1) PROCEDURE**

**(C1.11) MOVEMENT:** Units move from hex to hex on the mapsheet. Except in rare special cases [e.g., Black Holes (P4.0) or Nebulae (P6.5)], a unit moves a maximum of one hex per impulse and will probably not move during every impulse.

**(C1.12) HEXES:** Each unit must always be within a single hex and must always be "faced" directly towards one of the six adjacent hexes.



CORRECT



INCORRECT

**(C1.2) FACING**

**(C1.21) GENERAL:** A unit may be faced in any of six directions. These directions are designated by the letters "A" through "F." Note hex #4002 on the mapsheet. Arranged around this hex are these letters. This is a standard element of many games, used to designate direction. Units moving in "direction A" (which might arbitrarily be called "north") move in the direction they would move in IF they were in hex 4002 and were facing toward hex #4001 (the hex with the "A" written in it.) Thus a unit in hex 0608 facing in direction A faces hex 0607, while a unit in 2210 facing in direction C faces hex 2311.

The terms "facing" and "heading" are used interchangeably in these rules.

Hex #0328 on the mapsheet is surrounded by six numbered arrows. These are used for various functions, such as determining a random direction.

**(C1.22) MOVEMENT AHEAD:** Units generally move in the direction they are facing. Units turn (C3.0) to face a new hex before actual movement, but the unit will always enter the hex it is facing except as follows: Tumbling (C6.551), movement while docked (C13.921), movement while linked by tractor beam to another unit (G7.36), random movement caused by black holes (P4.0) or nebulae (P6.5), movement in reverse [in which case the unit enters the hex opposite the direction it is facing (C3.5)], and sideslips (C4.0).

**(C1.3) PLOTTING**

Players use the directional notations to plot the movement of their units. Players may elect, by mutual consent, either "pre-plotted" or "free" movement. The free movement system is assumed to be the standard system within these rules.

The terms "pre-plotted" and "free" are the most common of several levels of plotting; see (C1.33) for more details.

**(C1.31) FREE MOVEMENT:** Under the "free" movement system [Level B under (C1.33) below], whenever the movement chart calls for a given unit to move, the owning player may move it in any direction or combination of directions he wishes, within the limits of the unit's turn mode and other rules. Some items are always plotted, and the unit MUST have a legal speed plot; see (C1.34) and (C1.35)

**(C1.311) SIMULTANEOUS MOVEMENT:** When using free movement, it is possible for two or more units to be moving in the same impulse. When this happens, both players might gain a considerable benefit from knowing the other player's move. (This is not a problem with plotted movement, since the movement of the units is committed in writing beforehand.) To resolve which unit moves first, use the Order of Precedence in (C1.313).

**(C1.312) REVERSE MOVEMENT:** The intended direction of movement (forward or reverse) must be recorded on the Energy Allocation Form when using free movement. If no direction is indicated, forward movement is assumed. An announcement is required at the point of speed declaration.

**(C1.313) ORDER OF PRECEDENCE:** The following chart shows the correct order in which to move units that are moving in the same impulse. Units perform HETs during the step where they move. A non-moving unit is (within its category), the slowest moving unit, so a speed zero ship will HET before other ships move in the ship step.

1. Monsters move.
  - 1A. Change in Temporal Elevation (G31.152) except seeking weapons.
2. Ships move.
3. Nimble ships move (C11.0).
4. Fighters and shuttles (including those used as seeking weapons) move. If a shuttle is a seeking weapon and is targeted on another seeking weapon, the owning player has the option of declaring this fact (during the resolution of the order of precedence), in which case the shuttle moves in step 5.
5. Seeking weapons move or change Temporal Elevator (G31.0) levels. (Note that impact is announced but not resolved until after base rotation and tactical maneuvers. This allows tactical maneuvers to be used to turn a stronger shield toward an incoming-seeking weapon. The weapon hits the shield *after* the rotation or TAC.) If one seeking weapon is targeted on another seeking weapon, the owner of the weapon so targeted may announce this fact (during the resolution of the order of precedence); weapons known to be targeted on other seeking weapons move after their targets have moved.
6. Bases rotate (C3.7).
7. Ships make tactical maneuvers (C5.0).
8. Nimble ships make tactical maneuvers.
9. Fighters make tactical maneuvers. Non-fighter shuttles cannot TAC; see (C5.43).

Within these groups, the slower unit moves first. If the speeds are equal, the unit with a better turn mode category moves last. If speed *and* turn mode category is the same, both players write down their movement for that impulse only and expose these written orders simultaneously, then execute them.

The COMMAND CARDS provided in Captain's Module A will facilitate this procedure.

When using plotted movement, this chart can be used to set the order for any non-plotted movement, such as tactical maneuvers.

**NOTE TO NEW PLAYERS:** Sections (C1.32) and (C1.33) should be ignored for now. These sections deal with a very complex form of movement planning (known as "pre-plotted movement") which is seldom used. These sections can, for all practical purposes, be treated as optional rules and can be totally ignored. These rules are included primarily for the benefit of players who grew accustomed to the pre-plotted movement system in the earliest editions of the game. Certain advanced rules may use these pre-plotted rules, but beginning players will not encounter those for a considerable time.

**(C1.32) PRE-PLOTTED MOVEMENT (Optional):** Under the "pre-plotted" movement system [Level C1 under (C1.33) below], players must specifically plot the movement of their units for the current turn in advance, during the Energy Allocation Phase. Note that "seeking weapons" are not plotted, but follow their designated targets. A simplified notation is used, wherein "2A" indicates two hexes in direction A, and "4C" indicates four hexes in direction C.

Note that under all forms of plotted movement, it is not necessary to plot the launching of seeking weapons, launch of shuttles, firing of weapons, etc. See (C1.35).

**EXAMPLE:** A Klingon D7 battlecruiser is in hex 1021, facing hex 1122. The Klingon has decided to expend 10 units of energy in movement on this turn. Since his movement cost is 1 energy point per hex, he will move 10 hexes. A Kzinti strike cruiser is in hex 1520, facing hex 1420. The Klingon anticipates that the Kzinti ship will move slowly, if at all, on the current turn (due to tactical circumstances too complex to explain here). The captain of the Klingon ship wants to maneuver to bring himself behind the Kzinti ship, facing it at close range. He plots movement as (4C, 2B, 2A, 2F), a classic "Klingon Hook" maneuver. This movement will take him, successively, into hexes 1122, 1222, 1323, 1423, 1523, 1622, 1621, 1620, 1520, and finally to 1419. His theory is that if the Kzinti ship does not move, or moves very slowly, he (the Klingon) will get a shot at his flank shields and finally overrun him. (Note that the firing arcs of the phasers on a D7 make the hex directly behind it a particularly bad place to be.) If the Kzinti moves quickly, the Klingon will still get at least one good shot early in the turn. Note that if the Kzinti ship is badly damaged, this maneuver should bring the D7 within transporter range (for boarding purposes). Also note that if the Kzinti ship is very badly damaged, plotting movement that will end the turn adjacent to it is inviting that ship to self-destruct and possibly take the Klingon ship with it.

There are several possible variations of pre-plotted movement. The basic system, as described above, is functionally complete. The variations listed below are not required, but may be used to increase the perceived realism of the game.

**(C1.321) HALF-TURN PLOTTING:** Plot the movement for each turn at the mid-point of the previous turn. (When a scenario begins, players plot the first turn, then, on Impulse #16, plot the entire second turn.) After half of the impulses of a given turn (i.e., 16) have been played, plot movement (and fill out the Energy Allocation Form) for the next turn. This will require even more inductive reasoning (and shrewd second-guessing) than the basic system. It is possible that, at the actual start of a turn, there may not be sufficient energy to perform all planned activities. In this event, the programmed energy expenditures must be reduced to the level of power available; the process in (D22.0) Energy Balance Due to Damage must be followed until the imbalance is corrected. This is obviously a very complex procedure, and only a few players use it.

**(C1.322) PURSUIT PLOTTING:** When using the various "plotted" systems, a unit can be directed simply to "follow" a given ship (or other unit, or simply a specific hex on the map). If so directed, the unit is moved as if it were a seeking weapon (F2.2), although of course with its own speed and turn mode. Should it enter the hex occupied by the unit it is following and then be required (by its speed) to move out of that hex before the target does, it moves straight ahead one hex and then begins "pursuing" the target again. Appropriate units could use Emergency Deceleration (C8.0).

**(C1.3221)** Ships not using pursuit plotting may adopt it at any point in the turn by announcing the fact; it takes effect four impulses (1/8 turn) later. These rules can also be used to adopt or drop Evasion or station keeping plot (see below). Changing to pursuit, evasion, or station keeping plot will, of course, cancel the original movement plot.

**(C1.3222)** Ships using pursuit plotting may drop it at any point in the turn by announcing the fact. The unit is released from pursuing its target eight impulses (1/4 turn) later. It must plot the remainder of the turn at the time the unit is released from pursuit plotting.

**(C1.3223) EVASION PLOTTING:** A unit may also use evasion plotting, in which the unit always moves in such a way as to move farther from a given ship, unit, hex, or object. If it is not possible to get farther away, the unit must (if possible) move in such a way as to get no closer. See (C1.322).

**(C1.3224) STATION KEEPING PLOT:** A unit may also use station keeping plot, in which the unit always moves in such a way as to maintain (as nearly as possible) or attempt to restore the distance between itself and another unit, hex, or object (based on the distance at the start of the turn or adoption of this type of plot). The unit is not obligated to remain in any given direction or orientation from the target unit. ECM drones (FD9.0) use station-keeping plot during parts of their movement. See (C1.322).

**(C1.3225)** Units cannot plot pursuit or station keeping on any unit under friendly control unless the unit being followed is using plotted movement at the same level as the following unit. For example, you cannot plot pursuit movement on a probe drone (which does not use plotted movement) which you control.

**(C1.3226)** Note that while this form of plotted movement uses the same mechanics as "seeking weapons" (F2.2), this type of plot does not result in an impact or collision and is not distracted by scout sensors, chaff, wild weasels, going behind a planet, etc. If the object of the plot goes behind a planet, the following units will maneuver to fulfill the requirements while avoiding planetary collisions. If the object of the plot is destroyed, use (C1.3222) to drop the pursuit, continuing to pursue the hex that the target was destroyed in until entering that hex or until the eight impulse delay in (C1.3222) is complete.

**(C1.3227)** Station keeping, evasion, or pursuit plotting cannot be performed if a cloaked unit is the object of the plot.

**(C1.323) SEGMENTED PLOTTING:** Plot the unit's activities for the first eight impulses. At the end of Impulse #4, plot the activities for impulses #9-12. At the end of impulse #8, plot #13-16, and so on. Thus, a player will always be plotted for 4-8 impulses in advance. Players may experiment with other combinations such as 5-10, 15-30, 2-4, etc. Players fill out their Energy Allocation Forms at the end of Impulse #28 of the previous turn. Use (D22.0) to resolve any energy imbalance at the end of a turn.

**(C1.33) LEVELS OF PLOTTING:** There are several "levels" of plotted movement. Under the more restrictive levels, all movement-based actions must be plotted. Under the more liberal levels, many actions can be made freely. Note that the various forms of segmented plotting are variations of all levels, not a level themselves. Also note that energy allocation and movement plotting are related but not the same. Allocating energy for a high energy turn is not the same as plotting to make such a turn at a specific point.

**A: MODIFIED FREE MOVEMENT:** Players can perform speed increases (C12.24) and HETs (C6.0), and switch to or from erratic maneuvering (C10.0), without prior plotting, assuming energy is available from reserve power (H7.0) or contingent allocation (H7.6). Contingent allocation (H7.61) is authorized only for HETs and EM, not for speed changes. [Plotting speed changes may, however, have some advantages in power efficiency; see (C12.24).] This level can be substituted for the standard level (B) without affecting game balance while providing more advanced movement options and tactics.

**B: STANDARD FREE MOVEMENT:** Same as A, except that unplotted speed changes by (C12.24) are not allowed. This is the standard procedure for the purposes of all rules, scenarios, and game balance.

**C: LIBERAL PLOTTED MOVEMENT:** Same as C1 below, but PFs and satellite ships can be launched at any point, with their movement for the remainder of the turn plotted at time of launch. This level also allows the unplotted use of HETs (with the balance of the movement plot "rotated" by the appropriate amount), or an HET can be used when converting to evasion plot.

**C1: STANDARD PLOTTED MOVEMENT:** Plot all movement (including HETs) hex by hex only for ships (including PFs).



Shuttle and fighter movement is not plotted. Allow ships to change between pursuit, station keeping, and evasion plotting according to the rules. See (C1.35) for all forms of plotted movement. See (C3.433) and (C5.42) for tactical maneuvers.

**D1: PLOTTED SHUTTLE MOVEMENT:** Same as C1, but the movement of shuttles must be plotted. This level allows launch and recovery of shuttles at any point, with the shuttle's movement for the rest of the turn plotted at the time of launch. (Note that satellite ships and PFs, being ships, effectively use D1 while at level C or C1.)

**D2: OPTIONAL SHUTTLE MOVEMENT PLOTTING:** Same as C1, but also requires that the launch, recovery, and movement of shuttlecraft (including fighters), satellite ships, and PFs be plotted at the start of each turn. This restriction is not required with E; you can specify "plotting level E without option D2" if you wish.

**E: RESTRICTED MINE PLACEMENT:** Same as D1, but also requires that the placement of mines (by transporter or by laying) be plotted. As the use of transporters requires dropping a shield, the player can voluntarily cancel the plotted laying of mines by transporter if he does not wish to drop the shield.

**(C1.34) ALWAYS PLOTTED:** The following items are always plotted at all levels: Docking (C13.0) except PFs and satellite ships at some levels, damage control (D9.2), continuous damage repair (D9.7), repairs (G17.0), guards (D7.83), reloading weapons, deck crew operations (J4.8), changing modules on a modular PF (K2.38), emergency damage repair (D14.0), self-destruction (D5.0).

Note that the speed of the unit is always plotted; *the unit must always have a legal speed plot*. All deceleration must be plotted (including braking energy to reverse direction), except an emergency deceleration, which is never plotted.

**(C1.341) LEGAL SPEED PLOT:** The legal speed plot [which will be a single constant speed unless using mid-turn speed changes in Advanced Missions, in which case see (C12.12) for details] cannot include the anticipated effects of emergency deceleration (C8.25), which is never plotted (C1.35). For example, if the ship is moving at speed 20 for the entire turn, it must allocate sufficient energy for this movement even if the player is absolutely certain that he will be using emergency deceleration on some specific impulse. He cannot plot emergency deceleration for a given impulse and use the movement energy for the remainder of the turn for other purposes.

**(C1.342) COMPUTER SHIPS:** Ships fighting against computer-controlled ships use plotted movement; see (G11.12).

**(C1.35) NEVER PLOTTED:** The following items are never plotted at any level: firing weapons (E1.0), using tractors (G7.0), using reserve power (H7.0), launching seeking weapons (including scatter-pack and suicide shuttles) (F0.0), probe launch (G5.0), dropping chaff (D11.0), transporters (G8.0) (except mines and satellite ships where noted), hit and run raids (D7.8), raising or dropping shields (D3.5), launching wild weasels (J3.0), cloaking or uncloaking (G13.0), displacement (G18.0), laboratory functions (G4.0), deceleration due to damage (D22.0), dropping pods (G14.3), dropping warp booster packs (K1.62) and (J5.22), ship separation (G12.0), catastrophic damage (D21.0), EW changes (D6.315), and emergency deceleration (C8.0).

### (C1.4) PERFORMING MOVEMENT

Each unit will move one hex, and only one hex, during each impulse in which movement is called for by the IMPULSE CHART. If a player allocates energy for 16 hexes of movement, his ship will move one hex in each of 16 impulses (specified by the Impulse Chart) during that turn.

**NOTE:** Involuntary movement not under control of any player [e.g., black hole (P4.0)] is in addition to movement plotted by the players.

**(C1.41) GENERAL:** The actual movement (and other functions) is done during the Impulse Procedure; see (B2.3), Explanation of the Sequence of Play.

Each turn is divided into 32 impulses; see (C1.5).

**(C1.42) MAXIMUM SPEED:** The maximum allowable speed in the game is 31 unless specifically excepted; for example, see plasma torpedoes (FP0.0) and fast drones which move at speed 32. Other exceptions will be noted in their specific rules; e.g., an enraged mother space dragon (SM7.468) or a striking moray eel (SM3.45). See (C1.45) to handle these faster units.

**(C1.43) MOVEMENT PROCEDURE:** During the Impulse Procedure, the various units on the map (including shuttles, drones, and plasma torpedoes) are moved by a proportional movement system. In simple terms, this means that if unit "A" is moving at 10 hexes per turn, unit "B" is moving at 5 hexes per turn, and the turn is divided into a number of impulses (with no unit moving more than one hex per impulse), then unit "A" will move during twice as many of those impulses as unit "B" and will, of course, move twice as far. A more detailed version of the procedure is included in the Explanation of the Sequence of Play (B2.3).

**(C1.44) THE CONTROLLER:** During the course of the game, one player assumes the duties of "controller." These duties consist of reading the IMPULSE CHART and informing the various players when their units move. There is no particular advantage to being the controller, but in large scenarios it may be preferable to have a non-playing person act as the controller to prevent slowing down the game.

**NOTE:** The Impulse Cards provided in Captain's Module A will greatly simplify the controller's job and will take much of the burden from a player who is also serving as controller.

At the start of the Impulse Procedure, the controller should lay the movement chart out flat and place a sheet of scratch paper over it, just below the column headings. On the edge of this sheet, under the speed column heading for the speed of each unit on the map that turn, he should mark some identifying initial or mark for that unit. Then, as each impulse begins, he lowers the sheet of scratch paper by one row, announcing the units that move in that particular impulse. For example, on Impulse #7, a unit that was moving 10 hexes per turn would be told to move its second impulse of movement.

**No impulses are skipped,** even if no unit is scheduled to move. Units may still fire/launch weapons and perform other functions in those impulses. For example, let us assume that in a given scenario, there is a Federation cruiser moving at a speed of 7, a Klingon D7 moving 11, and a Klingon drone moving at a speed of 8. The controller sets up his sheets and marks the 11, 8, and 7 columns.

No units move during Impulses #1 and #2 although weapons could be fired. The D7 will move in Impulse #3, the drone in #4, and the cruiser in #5. During Impulse #6 the D7 will move. No units move during Impulse #7, but during Impulse #8 the drone moves its second impulse. The D7 moves again in Impulse #9 (note, however, that the D7 is moving ITS third impulse) and the cruiser moves in Impulse #10. Nothing moves during Impulse #11, but during Impulse #12 the D7 and drone move. (There are, of course, 20 more impulses, but it would be rather tiresome to go through them all.)

**(C1.45) FASTER MOVEMENT:** In some very unusual cases a unit could actually move (under its own power) two or more hexes during a given impulse. (This can also happen with units moving under two different forms of movement, such as normal engine power and black hole movement on the same impulse.)

**(C1.451)** In such cases, the normal turn procedures still apply. The "super-fast" unit simply moves two (or whatever) hexes, and the turn proceeds normally. While other units may have missed a firing opportunity, this is simply a function of the high speed of the "super-fast" unit.

**EXAMPLE:** A ship is in hex 1010 and a "super-fast" unit (in this case an enraged mother space dragon) is in hex 1007 heading toward it at a speed of three hexes per impulse. The ship could have fired at the dragon at range 3 on the previous impulse, but after the movement portion of this impulse, the dragon will be in the same hex as the ship (and probably doing the ship no good at all); i.e., there will be no firing opportunity at ranges 2 or 1.

**(C1.452)** The "super-fast" unit completes its entire movement (for that impulse) at the point in the Order of Precedence when it is scheduled to move. (Note that involuntary terrain-induced movement is performed at an earlier step in the Sequence of Play and is never part of the Order of Precedence.) This movement must be within the movement rules through legal hexes.

**(C1.453)** If struck by seeking weapons during this movement (e.g., by running into the weapons), the damage is resolved at the normal point in the Sequence of Play as separate volleys (for each hex of movement and each shield struck).

**(C1.454)** If the "super-fast" unit strikes a mine (or some type of terrain that causes damage), any resulting damage to the "super-fast" unit is resolved immediately at that point during the Movement Step (before moving to the next hex). Any damage by the mine to other units is resolved at the normal point in the Sequence of Play (assuming simultaneous detonation of all such mines). Any terrain effects, such as asteroids, are rolled at the highest speed column on their respective charts, shifting the die roll by one in the least favorable direction (6+1 remains 6; 1 - 1 remains 1).

**NOTE:** At the time this rule was written, it applied only to an enraged mother space dragon (SM7.0) defending her young or to a "striking Moray Eel" (C1.42). New rules in development, however, could produce more units moving at speeds beyond 32, and this rule was included to cover that possibility.

**(C1.46) CLOSING TRAJECTORY:** It is possible that two units could be heading toward each other and happen to move on the same impulse. This can create lost firing opportunities.

For example, a Klingon D7 and a Federation CA are heading toward each other and are 5 hexes apart. Both move on this impulse, and the resulting movement places them 3 hexes apart. There is no opportunity to fire at range 4 (even though the Federation Captain would rather trade fire at that range where the Klingon ph-2s are ineffective).

In another case, a Kzinti drone and a Klingon D7 (with no phasers available to fire) might be heading toward each other. The Klingon player would like to tractor the drone to prevent its impact, but has only one point of reserve power and so can only do this at range 1. But the drone is 2 hexes away and both the ship and drone are scheduled to move, and if both move straight ahead, the drone will enter the hex and strike the Klingon ship before the tractor can engage. To avoid this problem, the D7 sideslips to the right, avoiding impact during this impulse. The D7 then tractors the drone and destroys it with a phaser during the next turn.

### (C1.5) ADDITIONAL MOVEMENT CHARTS

Earlier editions of Star Fleet Battles included charts for various numbers of impulses so that players could use the smallest number of impulses required for the speeds of the units in play, thereby saving themselves the trouble of going through the Sequence of Play 32 times.

However, these charts are no longer included because of the problems of translating the time interval requirements of various rules (written for 32 impulses) into a variety of other impulse intervals.

Experienced players found that the 32-impulse chart was actually more flexible and did not actually consume any more time as there were only so many weapons to fire anyway.

There was also the problem of someone launching a fast seeking weapon in the middle of a turn that was set up with a slower chart. This required switching charts in mid-turn, a procedure requiring higher-order mathematics and a computer with at least 5 megabytes of RAM. Or to state things more clearly, ignore rule (C1.5).

### (C1.6) STACKING

**(C1.61) NO LIMIT:** Players are permitted to freely stack counters within a given hex. There is no limit as to the number of counters that can occupy a hex.

**(C1.62) INDEPENDENCE:** Each counter is still treated independently for all purposes. Each weapon fired (or moving) into a hex is directed at ONE (and ONLY one) counter within that hex.

There is a partial exception in (D15.52), where shuttles conducting ground assaults can form into convoys.

**(C1.63) GROSS EFFECTS:** Explosions (D5.0), Terrain (P0.0), and Mines (M0.0), as well as WW collateral damage (J3.3), damage all units in each affected hex equally.

### (C1.7) RAMMING AND COLLISIONS

There is no provision in Star Fleet Battles for ramming or colliding with another unit. No rules for this will ever be added to the game. Ramming is prohibited; accidental collisions between units are so unlikely as to be considered effectively impossible. (Note that docking, landing shuttles, ESG interactions, running into webs, crashing into a planet, and seeking weapons impacts are not considered to be ramming.) Exception, dogfighting shuttles may collide; see (J7.662).

### (C2.0) ENERGY COST OF MOVEMENT

#### (C2.1) GENERAL RULES

Movement is expressed in movement points (also known as "movement factors" or "hexes of movement"). Movement points are purchased by expending energy. Each ship buys movement points at a specified rate based on its size and efficiency.

During the Energy Allocation Phase of each turn, each player records on the Energy Allocation Form(s) a number of energy points for movement for each of his ships. This is the amount of energy allocated to movement.

**(C2.11) LIMITS ON POWER USED:** Energy allocated to movement can only come from warp engines or impulse engines.

**(C2.111) IMPULSE LIMIT:** One point of impulse engine (H3.0) energy always yields one hex of movement, regardless of the size of the ship. [Exception: Impulse power cannot move a large asteroid (P3.43).] See also (H3.4), (G7.36-B), and (C14.13) for other uses of and conditions on impulse power.

No more than one point of energy may come from impulse engines for purposes of regular movement, braking (C3.52), and/or sublight tactical maneuvers (C5.12) during any given turn (total of one point, not one point for each listed function). Impulse energy used for erratic maneuvers (C10.11) or for stabilization of orbit (P8.43) is not included in this limit.

Impulse energy can never be used for HETs (C6.0) or warp tactical maneuvers (C5.2).

**(C2.112) WARP LIMIT:** No more than 30 movement points (per turn) can come from the warp engines (H2.0). Note that this restriction (generating 30 movement points) is "practical speed" (C2.411) and includes all possible conditions, such as towing (G7.32), Orion engine doubling (G15.26), tug pods (G14.34), or breaking through webs (G10.561). Note that HETs (C6.0) and erratic maneuvers (C10.0) are rated in movement points, but are not included in this limit [i.e., in the practical speed (C2.4)]. This paragraph is critical in the interpretation of other rules and interaction with them. See also (C12.38) for an additional restriction. It should be noted that warp-tacticals don't come under this limit, but since you can't do them at speed 30 it's pretty much irrelevant.

**EXAMPLES:** Two Gorn cruisers are engaged in a tractor link (G7.36); both have a movement cost of 1 and 32 warp. Neither can use more than 30 points of warp, even if one of them was not moving at all. They could not use (G10.561) to have one pull the other out of a 31-point web. An Orion CR towing a second CR could not generate more than 30 movement points with warp energy, even with his engines doubled.

**NOTES:** There is a partial exception in the case of some tugs; see (G14.34). In some cases, warp power cannot be used for movement; e.g., (C14.12).

**(C2.12) WARP MOVEMENT POINTS:** Warp movement points are generated by taking the number of warp engine energy points (those which have been allocated for movement) and dividing this number by the movement cost of the ship. This movement cost is shown on the SSD sheets and on the MASTER SHIP CHART (Annex #3). Each resulting warp movement point yields one hex of movement.

**(C2.13) COMBINED WARP AND IMPULSE:** The movement provided by warp energy and impulse energy is totaled, and the result is the total number of hexes that the ship will move during the current turn.

**EXAMPLE:** A Federation destroyer has a movement cost of 1/2. On a given turn, it allocates one point of impulse engine energy and six points of warp engine energy. The six points of warp engine energy are divided by the movement cost to yield 12 hexes of movement; the impulse energy provides another movement point. The ship will move 13 hexes during the current turn.

**(C2.14) SUBLIGHT SHIPS:** Certain ships (e.g., Romulan Warbird) have no warp engines, but only impulse engines. These ships can never move more than one hex per turn under their own power and cannot move and use tactical maneuvers on the same turn. (There is also a Romulan sublight shuttle, which moves one hex per turn.)

When towing sublight units, see Annex #7L in Advanced Missions for towing costs. (The Warbird is the only sublight ship in Basic Set. It has a movement cost of 1.00. The Federation Battle and Starliner pods, when detached from a tug, are also sub-light units and are also in Basic Set.)

**(C2.15) NON-MOVING UNITS:** Certain units, primarily bases, have no engines and never move. Bases can rotate (C3.7) and be placed in orbit (P8.0).

**(C2.16) SPEED LIMIT:** No ship may exceed a practical speed (C2.411) of 31 during any turn. While ships move at considerably faster speeds in getting to and from their patrol areas, combat is impossible at those speeds, and all ships are presumed to slow to 31 (or slower) before entering a tactical scenario. Note that rule (C2.112) actually creates this limit as warp power can provide a speed of no more than 30 (impulse power provides the 31st hex of movement). Some units (e.g., fast drones and plasma torpedoes) are assigned a speed of 32.

**(C2.17) CONTINUOUS POWER REQUIREMENT:** It is necessary to keep expending power every turn to maintain movement. For example, if a given ship (with a movement cost of one) expends 10 energy points for movement on Turn #1 and 3 points on Turn #2, its speed on Turn #2 is 3, NOT 10 or 13. Only the power spent on the current turn generates or sustains movement.

**(C2.18) WARP RESTRICTION:** This rule was moved to (C12.38).

## (C2.2) ACCELERATION

Movement at trans-light speeds is not, in the purest sense, movement, but rather the warping of space around the starship. As this is the case, there is no need for periods of "acceleration" as such. However, the energy conversion and transmission systems of the ships cannot suddenly change from a standing start to 512 times the speed of light (Warp 8). The time they require to generate the bending of space effectively creates a requirement for "acceleration."

**NOTE:** These rules apply to "ships." PFs use the same rules but can accelerate faster. Shuttles (which do not use energy allocation) have a simpler acceleration limit in (J1.22).

**(C2.21) MAXIMUM INCREASE:** When allocating energy to movement, the player may increase the ship's practical speed by a number which is equal to the previous turn's speed, or 10, whichever is greater. This includes warp and impulse power.

**EXAMPLE:** If speed on Turn #5 was 3, then it could be increased to no more than 13 on Turn #6 (13 is 10 more than 3). If speed is increased to 13 on Turn #6, then on Turn #7 speed could be increased to 26 (26 is double 13).

**EXCEPTIONS:** There are exceptions to this noted in the specific rule for each ship. For example: freighters (R1.5) and (R1.6), X-ships (X0.0), interceptors (K3.22), shuttles (J1.22), PFs (K1.22), and some monsters.

**(C2.22) UNLIMITED REDUCTIONS:** There is no penalty or restriction for reducing speed or maintaining a constant speed. See (C12.32) for an exception.

**(C2.23) ZERO SPEED:** A ship can stop by various means and, if it does so, will take considerable time to accelerate.

**(C2.231)** A ship can drop to zero speed during energy allocation or with mid-turn speed changes (C12.32).

**(C2.232)** If a ship reverses direction (C3.52), its speed is considered to be zero for purposes of acceleration on the next turn.

**(C2.233)** After suffering a breakdown (C6.541) or performing emergency deceleration (C8.4), speed is at zero for a defined period. See (C14.33) when undocking from a Tholian pinwheel.

**(C2.234)** Stopping resets the turn mode and sideslip mode to zero.

**(C2.24) THOLIAN WEB:** A ship caught in a Tholian web (G10.0) is considered (for purposes of acceleration) to have continued moving at its recorded practical speed (C2.411), even though it did not actually travel any hexes.

**(C2.25) EXCLUSIONS:** For purposes of acceleration, the movement point cost of high energy turns (C6.0), tactical maneuvers (C5.0), braking energy (C3.52), and/or erratic maneuvering (C10.0) is not considered to be movement. Having performed these maneuvers on a prior turn does not affect acceleration on the current turn (i.e., do not include them when calculating prior speed in order to determine the maximum speed on this turn); performing them on the current turn is not within the acceleration limits and has no effect on acceleration on the next turn.

## (C2.3) DECELERATION DUE TO DAMAGE

When a ship takes damage in combat, its speed may be reduced in mid-turn by damage to its engines. In this case, you may use the procedure in (D22.0) of Advanced Missions to resolve the energy imbalance resulting from damage whenever damage reduces the number of engine boxes. Note that this procedure will affect more than just movement.

This procedure was originally defined in this rule (C2.3) but was moved to (D22.0) when it was revised and greatly expanded.

## (C2.4) DEFINITION OF SPEED

The speed of a unit is the number of hexes that the unit moves during a turn, assuming no mid-turn speed changes.

If mid-turn speed changes (C12.0) are used, speed is defined as the rate of movement at any point, as if that current rate of speed were conducted over an entire turn.

**(C2.41) TYPES OF SPEED:** A unit in Star Fleet Battles can, simultaneously, have various "types" of "speed," each of which is used for a different purpose. These include:

**(C2.411) PRACTICAL SPEED** is the actual speed generated by the unit (or the rate, in terms of hexes per turn, at which it is currently moving), without any effects from objects being towed (or towing the unit) or terrain-induced movement (e.g., black holes). It is used for purposes of acceleration and reversing the direction (and is the only speed used for those purposes). Practical speed can never exceed 31; see (C2.16). Tugs may have their practical speeds adjusted when dropping a pod (G14.34); note that this does not apply to towing a pod which is not attached. Practical speed is used for disengagement by acceleration (C7.1).

**(C2.412) EFFECTIVE SPEED** is the actual number of hexes that the unit moves during the turn (or the rate, in terms of hexes per turn, at which it is currently moving) plus the cost of erratic maneuvers. This is used for purposes of mines, asteroids, dust, recovering fighters, destroying objects (e.g., shuttles) by towing them at high speed, collisions with small moons, docking, and web damage.

**(C2.413) PSEUDO SPEED** is used when moving while linked to another unit which is using its engines for movement (G7.36). In effect, both units are towing each other at the same time (and probably in different directions). Pseudo-speed is used for purposes of (G7.36) and turn modes. See (C2.46).

**(C2.414) MANEUVER RATE.** This is not actually speed, but is the Practical Speed plus the cost of certain movement-related functions and actions (C2.42). It is used primarily for purposes of cloaked ships and wild weasels.

**(C2.415)** Note specifically that during most circumstances all four "speeds" will be the same. To have four different ratings, the ship would have to be moving, linked by tractor to another ship which was itself moving, conducting movement-related activities that cost but did not produce movement points, and be in a nebula or near a black hole (i.e., this rule is not nearly so complicated in use as it is in definition).

**(C2.416)** Unused energy held as reserve warp power is not included in calculating any version of the ship's speed. Warp power used for non-movement purposes is not included in any version of the ship's speed.

**(C2.417)** Turn modes are based on the practical speed unless this is different from the pseudo-speed, in which case the pseudo-speed is used.

**(C2.42) MANEUVER RATE:** For purposes of cloaked ships (G13.331) (and all other cloaked speed calculations.), or speed restrictions to avoid voiding a wild weasel (J3.13), the movement point cost of certain functions and actions is added to the practical speed to produce the maneuver rate. These functions and actions include:

- High Energy Turns (C6.21),
- Tactical Maneuvers (C5.12) or (C5.22),
- Braking Energy (C3.52), and/or
- Erratic Maneuvering (EM) (C10.11).

The maneuver rate is based on the electronic signature (specifically "exhaust") produced by the engines; it does not include engine power used for non-movement purposes.

The maneuver rate is not actually "speed" in the sense used elsewhere. The maneuver rate effectively makes it impossible for a ship protected by a WW to use EM or to perform an HET without voiding the WW. Note that a nimble ship (C11.0) moving at speed 1 could perform EM and not void the WW due to the low EM cost for nimble ships.

Maneuver rate does not include terrain-induced movement; see (C2.45).

**(C2.421)** The maneuver rate differs from the practical speed only if the maneuvering energy is actually used. If a ship allocates energy for a high energy turn, the cost of this maneuver (equal to five hexes of movement) is not added to the ship's maneuver rate until the maneuver is actually made, at which point it would be added to the ship's practical speed (which may vary) to become the maneuver rate.

**(C2.422)** The cost of an HET is included in the maneuver rate of the ship only for the impulse in which the HET is made. An HET made before the ship cloaked (or launched a weasel) would not count in the maneuver rate.

**(C2.423)** The cost of erratic maneuvers (C10.0) is added to the maneuver rate of the unit during any impulse in which the unit is performing EM, and only during those impulses. The use of EM which is terminated before a WW is launched would not void the weasel. Note that unit under cloak cannot use EM (G13.59).

**(C2.424)** The cost of tactical maneuvers is added to the maneuver rate for the remainder of the turn, starting at the time the maneuver is made (not when it is earned). This cost is cancelled if the ship begins moving during the turn.

**EXAMPLE:** With a nimble ship (C11.28) (able to make a speed change in 6 impulses) and an outstanding crew (G21.224), it is possible to TAC on Impulses #2, #3 (impulse), #6, #11, change speed (C12.0) to four on Impulse #12, move on Impulse #16, change speed to zero on Impulse #18, and TAC again on Impulses #22, #27, and #32. Total of six TACs and one hex of movement, none of which void the weasel.

**(C2.425)** Braking energy is included within the maneuver rate for the impulse in which it is used only; see (C3.52).

**(C2.43) CALCULATIONS:** The effective speed, pseudo speed, and maneuver rate are all calculated independently of each other based on the practical speed. These calculations are mathematically summarized below. These summaries explain, but do not create, the rules in the relevant sections.

Practical Speed = Warp engine power allocated divided by movement cost, + (possibly) one point for impulse power.

Effective Speed = Practical speed + Cost of erratic maneuvers + Terrain-induced movement (black holes, nebulae, webs).

Maneuver Rate = Practical speed + cost of HET (during that impulse) + cost of braking energy (during that impulse)+ cost of tactical maneuvers (as used)+ cost of erratic maneuvering (while in effect).

Pseudo Speed = Warp power allocated divided by the movement cost of the combination of units, + (possibly) one point for the impulse power.

**(C2.44) RECALCULATION:** The four types of speed are recalculated immediately whenever the component conditions change.

**(C2.45) EFFECTIVE SPEED:** The practical speed of a ship does not include the effects of terrain induced movement, such as being pulled toward a black hole (P4.0) or the random movement inside a nebula (P6.5). This movement, when added to the practical speed, results in the effective speed. The cost of erratic maneuvers and the loss of movement due to a web is also included in the effective speed. Effective speed does not include the cost of HETs or Tactical Maneuvers. If two ships are connected by tractor beam, their effective speed is equal to the sum of their pseudo-speeds, plus terrain-induced movement.

**(C2.451)** Effective speed, being the actual rate at which the unit is moving through space, is used for purposes of mines, asteroids, rings, dust, recovering fighters, destroying objects (e.g., shuttles) by towing them at high speed, collisions with small moons, docking, and web damage.

**EXAMPLE:** If a ship is moving at a (practical) speed of 4, but its movement during the turn includes one additional hex caused by a black hole directly ahead, the ship has moved 5 hexes and when passing a mine would roll a die based on that effective speed. If, however, the ship was moving at a practical speed of 5 away from the black hole, with the movement effects of the hole "slowing" it to 4, the die roll would be based on a speed of 4.

**(C2.452)** Effective speed is not used for purposes of gaining or retaining a lock-on to a cloaked ship or for wild weasel speed restrictions. See (C2.414).

**EXAMPLE:** If a ship is moving at a (practical) speed of 4, but its movement during the turn includes one additional hex caused by a black hole directly ahead, the ship has moved 5 hexes but as the maneuver rate is still 4 the WW is not voided. If, however, the ship was moving at a maneuver rate of 5 away from the black hole, with the movement effects of the hole "slowing" it to an effective speed of 4, the WW is still voided.

**(C2.46) PSEUDO SPEED:** Units towing other units use their pseudo speed to determine when each of them will move the entire combination. See (G7.36-B) for the calculation of pseudo speed. Fractional points of movement are lost.

**EXAMPLE:** A D6 and a CA are tractorated together. The D6 was moving at speed 14 and the CA at speed 10. During the turn, they are moved one hex by a black hole. The combined ships now have an effective speed of 13 [(14/2) + (10/2) + 1 = 13], their pseudo speeds are 7 (Klingon D6 = 14/2) and 5 (Federation CA = 10/2), and their practical speeds remain 14 and 10 respectively. If mid-turn speed changes are involved, these speeds will each be calculated as if the individual ship was going to move at the current speed for the entire turn and recomputed at the point where the mid-turn speed change is announced, i.e., after the last move at the current speed and before the first move at the new speed.

**(C3.0) TURNING AND TURN MODES**

Each unit in the game which moves at trans-light speed (more than one hex per turn) must maneuver (i.e., turn) within the limits of its "turn mode". This "turn mode" is the factor that defines how quickly a given unit can turn (i.e., change facing).

Players will have to bear with one of the limitations of the English language in the overuse of the word "turn." It can be your turn to move on Turn #3, you may choose to make a left turn or perhaps a high energy turn, and if you are not careful, things may take a turn for the worse.

Similarly, an "impulse" is one of 32 segments of a turn, which has nothing to do with "impulse engines" on ships.

**(C3.1) TURNING**

The actual act of turning the unit by 60° is done at the start of a given impulse (immediately before moving into the next hex) and NOT at the end of the impulse (after entering a given hex). A unit's turn mode regulates how often a 60° turn can be made.

Note that various other maneuvers, such as High Energy Turns (C6.0) and Tactical Maneuvers (C5.0) can also produce a facing change and hence, in effect, a turn.

See (C4.4) for an illustrated example.

**(C3.2) DEFINITION OF TURN MODE**

**(C3.21) DEFINITION:** A unit's turn mode is the minimum number of hexes which the unit must move in a straight line [straight ahead, with same facing, see (C1.2)] before it can turn 60° (one hex side) right or left. After each 60° turn, the unit must again move the stated number of hexes straight ahead before it can turn again.

**(C3.22) ADJUSTMENTS:** Turn modes increase with speed; also, less maneuverable units have higher turn modes. Other factors, such as a tug carrying a pod (G14.0), being uncontrolled (G2.21), or erratic maneuvers (C10.55), may increase (worsen, lengthen) the turn mode. Legendary Navigators (G22.81) may improve the turn mode.

**(C3.23) CATEGORY:** A unit may appear to have two different types of turn modes. For example, each unit is assigned a Turn Mode Category (C3.3), also known as a Turn Mode Rating; for example the Federation CA has a Turn Mode (category) of D (the word "category" being unspoken). A ship with a turn mode (category) of D would have a turn mode (in the proper sense) of 3 at a speed of 9.

**(C3.24) SIDESLIPS** (C4.32) are considered to be straight-line movement for purposes of turn modes.

**(C3.3) ASSIGNMENT OF TURN MODES**

Each unit is assigned a turn mode category on the MASTER SHIP CHART. The turn mode category is designated by a letter, which, on the TURN MODE CHART, indicates the turn mode of that unit at various speeds.

**(C3.31) TURN MODE CHART** (see below)

**(C3.32) DETERMINING THE TURN MODE:** To determine the turn mode of each unit at its current speed, look under the column for that unit's turn mode category for the speed bracket that includes the current speed. Then, look across on that line to find the turn mode (the number of hexes the unit must move in a straight line between each turn). All turn modes apply at the current speed; see (C3.44).

A turn mode chart for each ship is included on its SSD.

There are various possible adjustments; see (C3.22).

See (C2.417) and (C3.554).

**(C3.33) SPEED OF ONE:** A unit moving at a speed of one (not using tactical maneuvers) moves on Impulse #32. It can turn 60° and move one hex directly ahead.

**(C3.4) RESTRICTIONS OF TURN MODES**

The hex entered on the impulse the turn was made counts as the first hex of straight-line movement for turn mode purposes.

**(C3.41) CARRYOVER:** Turn mode restrictions carry over from turn to turn. For example, a unit with a turn mode of 4 that moves 6A, 1B (six hexes in direction A followed by one in direction B) on a given turn must move B3 (three hexes in direction B) on the next turn before making a turn to C or A (assuming no HET or change of speed).

**(C3.42) CARRYOVER HEXES:** Hexes moved in a straight line at the end of a previous turn, if in the same direction (forward, reverse), may be counted toward fulfillment of a unit's turn mode. See (C3.24).

**(C3.43) STARTING FROM ZERO:** A unit starting from speed zero cannot turn before moving out of the hex because it has no way to satisfy its turn mode. If the owning player wants to turn before movement, the unit could perform an HET (C6.0) before movement, or move at speed one (C3.33), or perform a tactical maneuver at speed zero and then change speed (C12.0) and move normally.

**(C3.431)** A unit in a hex starting from speed zero must satisfy its turn mode (C3.0) before it can turn. This may require one or more hexes of straight forward movement, possibly including sideslips (C4.0). Obviously, if the unit is moving in reverse, this will be straight to the rear instead of forward.

TURN MODE	SEEKING WEAPON	SHUTTLE FIGHTER	AA	A	B	C	D	E	F
1	1-32	1-11	2-8	2-6	2-5	2-4	2-4	2-3	2-3
2		12-23	9-16	7-12	6-10	5-9	5-8	4-6	4-5
3		24+	17-24	13-19	11-15	10-14	9-12	7-10	6-9
4			25+	20-26	16-21	15-20	13-17	11-14	10-13
5				27+	22-28	21-27	18-24	15-20	14-17
6					29+	28+	25+	21-29	18-23
7								30+	24-29
8									30+

**SHIPS IN BASIC SET**

Drone Plasma Torpedo	Admin Shuttle Kzinti AAS Fighter		K: F5, E4 O: CR R: KF5R T: PC, PC+ Z: FF, EFF	K: D6/7 R: KR Z: CL	F: CL, DD, SC G: DD, DDF Z: CS, BC, CC S-AxCV F-S Q-S	F: CC CA, Tug+P G: CL, CA, BC K: C8/9 R: WE F-L Q-L	F: DN, BT, Tug+2P Z: CV, CVS	F: BT+P
----------------------------	---	--	---	---------------------------	--	--	------------------------------------	---------

**(C3.432)** Units moving at a speed of one hex per turn (C3.33) move on Impulse #32 and can turn before moving. Therefore, a unit that is stopped and which desires to turn before leaving the hex could do so by moving (at least initially) at a speed of one.

**(C3.433)** A unit which had been at speed zero and wished to move in some direction other than the one it is facing (perhaps there is a minefield in that direction) could make a tactical maneuver (C5.0) and then change speed (C12.0) to a speed greater than zero and move out of the hex in the new direction.

In the case of plotted movement (C1.32), it would be necessary to plot the direction of this tactical maneuver whereas tactical maneuvers that are not followed by movement would remain unplotted under the existing rules. See also (C5.42).

**(C3.434)** Seeking weapons launched from a ship (or other unit) are covered by various rules within their own sections and are not subject to this rule. Shuttles (including seeking shuttles), PFs, and Andromedan Satellite ships which have just launched from their carrier, tender, or mothership have not satisfied their turn or sideslip modes, and must move directly forward as their first movement unless they HET.

**(C3.44) SPEED CHANGES:** A unit which satisfied its turn mode at its current speed but did not turn, and which subsequently changed speed [either by (C12.0) or at the end of a turn], must satisfy the turn mode at the new speed. See (C3.32).

**(C3.441)** Movement in prior turns (C3.41), even if at a different speed, can be used to satisfy a turn mode.

**(C3.442)** Changing speed does not reset the turn mode.

**(C3.443)** A ship, which slows down to a speed at which the previously accumulated straightline movement would satisfy its new (lower) turn mode, may turn.

**(C3.45) RESET:** Performing an HET (C6.32), reversing direction (C3.554), being released from a pinwheel (C14.15), or stopping (C2.234) resets (i.e., reduces) the turn mode to zero. These effects also reset the sideslip mode. See (G7.331).

**(C3.46) TERRAIN:** Gravity Waves (P9.32), orbital movement (P8.0), and Nebulae (P6.5) may change the facing of a unit.

**(C3.5) REVERSING DIRECTION (Advanced)**

Ships normally move directly forward, turning 60° right or left as their turn mode permits. Ships may, however, also move backwards using exactly the same turning procedure.

**(C3.51) MIXED DIRECTION:** Ships may not mix forward and reverse movement during a single turn. The direction that a ship will be traveling (forward or reverse) must be noted during the Energy Allocation Phase. Direction can be changed only at this point. See possible exceptions in (C12.37). This rule (C3.5) assumes that mid-turn speed changes (C12.0) are not in use.

See also (C3.6) for Quick Reverse.

Seeking weapons (F2.14) and shuttles (J1.24) cannot move in reverse.

**(C3.52) BRAKING ENERGY:** Before a ship can reverse direction, however, it must pay a "braking energy" cost equal to its speed on the previous turn. This energy must be warp energy, except for one point that may be from impulse power (C2.111). Braking energy required is based on the cost of movement, not on the number of hexes of movement. Energy allocated to braking must be used. See (C8.102) for Emergency Deceleration.

**(C3.521)** The braking energy counts as movement for purposes of cloaks or WWs during the impulse in which it is applied (Impulse #1 if braking between turns); see (C2.42).

**(C3.522)** Braking energy reduces the ship to a speed of zero, from which point it can accelerate within its normal limits in the opposite direction. The energy spent for braking is part of the maneuver rate (C2.41) but does not count for purposes of acceleration.

**(C3.523)** When using mid-turn speed changes, braking energy is based on the highest speed in the previous 8 impulses; see (C12.371). Nimble ships (C11.28) use the previous 6 impulses.

**EXAMPLE:** If the ship (movement cost of one) was moving at a speed of 5 on Turn #6, it would pay five points of braking energy

(during Energy Allocation on Turn #7), and then could accelerate to a speed of 10 on Turn #7 (in the opposite direction).

**(C3.53) PLOTTING REQUIREMENT:** Braking energy and reversing direction must be plotted as part of the ship's required legal speed plot. See (C1.341).

**(C3.54) WARP OR IMPULSE:** A ship can move in reverse using warp or impulse power within their normal limits (C2.11) or a combination of the two.

**(C3.55) OTHER EFFECTS**

**(C3.551)** Braking does not stop erratic maneuvering (C10.0).

**(C3.552)** Braking does not affect an HET that has been paid for but not used.

**(C3.553)** Braking stops a positron flywheel (C9.0), i.e., reduces it to 0.

**(C3.554)** Braking (i.e., stopping) resets the turn mode (C3.45) and sideslip (C4.35) mode to zero.

**(C3.6) QUICK REVERSE (Advanced)**

Ships may attempt to reverse direction without paying the full braking energy cost.

**(C3.61) PROCEDURE:** The ship rolls a die in the Movement Segment of the impulse during which direction is reversed. (Roll on Impulse #1 in the event of a reverse between turns.) If the die roll is less than or equal to the shortage of braking energy (expressed in terms of movement points, not energy points), the ship suffers a breakdown (C6.5). Such a breakdown is treated the same as any other; the ship stops (or tumbles). If it tumbles (C6.55), this is at the speed and in the direction of the movement before attempting the reverse. If the ship does not breakdown, it has successfully reversed its direction and is treated in all respects as a ship using (C3.5).

**(C3.62) LIMITATION:** A ship cannot perform a quick reverse within 1/4 turn of an HET (C6.36) or another quick reverse.

**(C3.63) BREAKDOWN BONUS:** The bonus in (C6.52) is for HETs only; it cannot be used for quick reverse.

**(C3.64) OTHER CONDITIONS AND EFFECTS**

**(C3.641)** In the case of docked ships, see (C13.925).

**(C3.642)** Nimble ships have a bonus; see (C11.25).

**(C3.643)** Poor crews have a penalty (G21.126) while outstanding crews have a bonus (G21.226).

**(C3.644)** Legendary navigators have a bonus; see (G22.86).

**(C3.7) BASE ROTATION**

Bases (including starbases, battle stations, base stations, and other types in other products) may be set to rotate. The owning player may elect that the base will not rotate, in which case it will keep its facing throughout the entire scenario. The decision as to whether or not the base will rotate, and if so at what rate, is made by the owning player before the scenario begins and is announced before set-up takes place.

**(C3.71) SETTING ROTATION RATE:** The rate of rotation is at the option of the owning player, but may not be less than one 60° turn each turn, or more often than one 60° turn each eight impulses (1/4 turn). The rotation rate can be set by the player before the scenario, but cannot be changed during the scenario. The rate can be changed between scenarios except as specified. See (P8.3) for units in orbit and (C14.13) for Tholian pinwheels.

**(C3.72) PERFORMING ROTATIONS:** Bases rotate on the following impulses:

RATE	IMPULSES
4	4, 12, 20, 28
3	7, 17, 28
2	12, 28
1	28

**(C3.8) DIRECTED TURN MODES (Optional)**

This procedure is intended primarily for use by Mauler ships (E8.0) but could be used by other units.

Turn modes represent part of a circle. In theory, a unit which has completed its turn mode began turning (left or right) several impulses previously. In practice, a ship entering battle "satisfies its turn mode" without its player-captain having any idea if it will ultimately prove desirable to turn right or left. (Note the famous "Oblique Option Point" in the Tactics Manual when one makes a turn toward or away from the enemy only after evaluating the situation.) This fudge has been used in dozens of air combat and similar games since the term "turn mode" appeared in WWI air combat games back about 1972.

This procedure is more "accurate," but it is also more difficult to use and tends to restrict a player's ability to make decisions. Unrealistic though it is, players genuinely prefer to be able to make periodic snap turns based on the situation at the time. The only reason to put yourself to this effort and subject yourself to these restrictions is if you gain something from it (i.e., the optional offside firing arcs for maulers).

Players can decide if the mauler ships may make use of this procedure; if maulers are allowed to use it, other units are not required (indeed, allowed) to use it unless it is decided (perhaps in a quest for ultimate realism) that all units will use it. Even so, it is recommended that the number of units using it be limited to avoid bogging down the game; perhaps only ships would use it while fighters and PFs would not. Seeking weapons probably never should use it because of the bookkeeping nightmare that would result.

This rule has no effect on game balance. The added flexibility of mauler firing arcs is counter-balanced by the lack of maneuverability.

**(C3.81) DECLARATION:** At the start of the Voluntary Movement Stage of each impulse, each unit must declare if it is accumulating right, left, or neutral turn mode points. In the absence of any declaration, it is assumed to be continuing the direction of the previous declaration. Turning resets the unit's declaration to "neutral" unless it is declared otherwise.

**(C3.82) CHANGING DECLARATIONS:** A unit can shift to or from neutral from one impulse to the next, but cannot shift directly from right to left accumulation (or vice versa) without spending an intervening impulse at neutral.

**(C3.83) ACCUMULATION:** For each hex of movement which a unit spends "left" it gains one "left turn mode accumulation point" and vice versa. There are no "neutral" turn mode accumulation points. Being in "neutral" simply means you are going straight ahead, not accumulating any additional points or losing any previous points. Note that declarations are made every impulse while points are accumulated only as the ship moves.

**(C3.84) TABULATIONS:** Each unit keeps a running total of its turn mode accumulation points. A given unit can only have right or left points at any given time. If a unit already has "right" points and starts accumulating "left" points, these simply reduce the number of "right" points until that number reaches zero, then begins accumulating "left" points.

**(C3.85) TURNING:** When a given unit has accumulated a number of turn mode accumulation points equal to its turn mode at the current speed, it MUST turn in the indicated direction on the next impulse in which the unit moves. (To avoid turning when you don't want to, accumulate all but one of the points you need then shift back to neutral and wait until just before you want to turn.) A unit cannot turn until it has accumulated the required number of points.

Turning wipes out the accumulated total of turn mode points, which starts over from zero.

**(C3.86) SIDESLIP:** A unit may only sideslip in the direction in which it is accumulating turn mode points.

**(C3.87) MAULERS:** See the mauler rules (E8.27) for an explanation of how this arcane procedure may be worthwhile.

**(C3.88) FIRING ARCS:** The firing arcs of weapons other than maulers and probes fired as weapons are not affected by this rule.

**(C3.89) SPEED ZERO:** A unit which is at speed zero and makes a tactical maneuver, high energy turn, or zero energy turn may (immediately after that maneuver) declare itself to be at a left, right, or neutral orientation. A unit at speed zero cannot accumulate turn mode points. Base rotations cannot use directed turn modes.

**(C4.0) SIDESLIP (Advanced)**

The restrictions of the hexgrid used in this game creates certain limitations on the movement of units that do not correspond with reality. To correct this situation, units may execute a "sideslip" maneuver.

**(C4.1) SIDESLIP MODE**

A sideslip maneuver is executed during the Impulse Procedure. For purposes of sideslip maneuvers ONLY, all units at all speeds are assumed to have a "slip" mode of "1." After satisfying the requirements of this slip mode (i.e., moving one hex in a straight line since the last sideslip), the unit may execute a sideslip maneuver. After executing a sideslip, the unit begins counting again to satisfy the requirements of a sideslip. After satisfying the normal turn mode, it may make a normal turn; after satisfying the sideslip mode of "1," the unit may execute a sideslip. Turn modes and sideslip modes are recorded and satisfied independently of each other.

**(C4.2) PROCEDURE**

When executing a sideslip maneuver, the unit is moved into one of the hexes forward and to the side, but retains its original facing.

**EXAMPLE:** A starship in hex 3212 facing A has satisfied the requirements of either a turn or sideslip. If the owning player wanted to execute a turn on the next impulse when the ship is scheduled to move, it would be turned to face direction F and moved into hex 3112. If the owning player wanted to execute a sideslip, the ship would (when next scheduled to move) enter hex 3112 but retain its heading of "A."

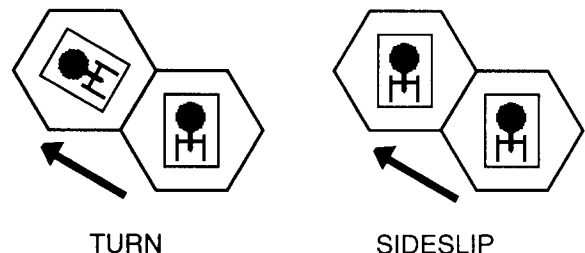
**(C4.3) RESTRICTIONS**

**(C4.31) HEX ENTERED:** For purposes of satisfying the sideslip mode requirement, the hex entered during the sideslip does not count.

**(C4.32) TURN MODE:** For purposes of satisfying the regular turn mode, the movement before, during, and after the sideslip counts as movement in the same direction.

**(C4.33) TURNING RESETS SIDESLIP MODE:** For purposes of satisfying the sideslip mode requirement, a regular 60° turn resets the sideslip mode to zero; the sideslip mode must resume at that point. A unit may not sideslip on the hex of movement made during a normal turn. (That is, a unit may not turn and sideslip on the same impulse.)

**EXAMPLE:** A ship is in hex 1119 facing A with both its turn mode and sideslip mode satisfied. It could:

- Move straight ahead to 1118.
- Turn 60° right and enter 1218 facing B.
- Turn 60° left and enter 1018 facing F.
- Sideslip right into 1218 facing A.
- Sideslip left into 1018 facing A.
- It could NOT turn AND sideslip into 1219 facing B.
- It could NOT turn AND sideslip into 1019 facing B.
- It could enter 1219 or 1019 or 1120 with an HET (C6.0).

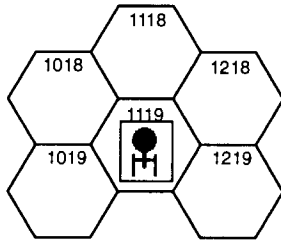

**(C4.34) COMBINATIONS:** A unit cannot combine a sideslip with a regular turn or high energy turn.

**(C4.35) STOPPING** resets the sideslip mode to zero; see (C2.234) and (C3.554). A high energy turn resets the sideslip mode to zero; see (C6.32).

**(C4.36) RESET:** Performing an HET (C6.32), reversing direction (C3.554), being released from a pinwheel (C14.15), or stopping (C2.234) resets the sideslip mode to zero. These effects also reset the turn mode. See (G7.331).

**(C4.4) EXAMPLE OF TURNS AND SIDESLIPS**

In the example below, a Federation CA (heavy cruiser) is moving at speed 13 (resulting in a turn mode of 4). The ship is suddenly confronted with a threat directly ahead. It cannot turn in hex #1 because that hex is the third it has entered since its last 60° turn (i.e., its turn mode is unfulfilled). It can also be assumed that the ship entered hex #1 by a sideslip.

The ship then moves ahead into hex #2, fulfilling its turn mode (and sideslip mode).

On the next impulse, it could enter hex #3 by a turn or a sideslip, but it elects to turn right instead as it wants to evade the approaching threat. (The ship would have probably fired the right phaser bank while in hex #2 since this bank could not fire on the threat after the turn, at least not until the ship turned again.)

The ship could move straight ahead from hex #3, but instead sideslips into hex #4 to keep as far as possible from the approaching threat.

Having neither its turn mode nor sideslip mode fulfilled, it has no choice but to enter hex #5. (It could have used a high energy turn, but for our purposes we can assume that, unaware of the unexpected threat, the captain had not allocated the five points of power required for that maneuver and a Federation CA does not have enough reserve power to do this maneuver entirely with reserve power.)

Having fulfilled its sideslip mode by the move into hex #5 (being directly ahead from #4), the ship can sideslip into hex #6. Note that without sideslips, the ship would be two hexes "north" of its present position, and that much closer to the enemy.

Having now fulfilled its turn mode (which required four hexes of forward movement without a turn; the sideslips counted as forward movement), it can (and does) turn another 60° right to enter hex #7.

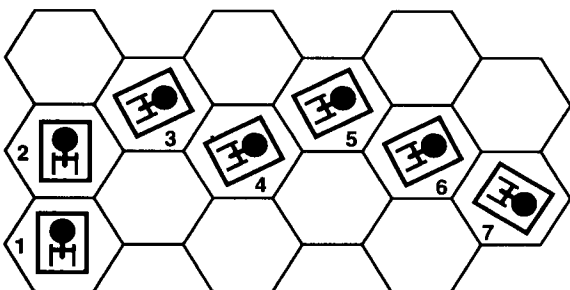

**(C5.0) TACTICAL MANEUVERS (Advanced)**

From time to time a ship's captain may be unable or unwilling to move the ship out of the hex it occupies, but the captain may still want to retain the ability to turn his ship from side to side to respond to enemy operations (e.g., to turn a new shield toward an attack or to bring other weapons into firing arc). This is known as a tactical maneuver.

There are two types of tactical maneuvers: sublight tactical maneuvers (sometimes-called impulse tactical maneuvers) and warp tactical maneuvers. The general term "tactical maneuver" refers to both types as a class of maneuvers.

**NOTE:** These rules are written for "ships" which must allocate energy for tactical maneuvers. Fighters can also make tactical maneuvers under special rules in (C5.43).

**(C5.1) SUBLIGHT TACTICAL MANEUVERS**

Players operating ships which cannot move at trans-light speeds (for example, a Warbird or a badly damaged ship) or who, on a given turn, do not wish to move at trans-light speed may move in sublight movement (one hex per turn) or use "tactical maneuvers."

**(C5.11) PROCEDURE:** A player wanting his ship to make sublight tactical maneuvers may write "TAC" in his movement plot indicating the intention to use high sublight speed for tactical maneuvers. In this case, the ship does not actually move (it remains in the hex it is in), but on any impulse except impulse #1, it may make ONE 60° turn.

**EXAMPLE:** A Romulan Warbird is in hex 0305, facing hex 0304. The owning player has the option of using normal movement, in which case he could move his ship either "1A" (which would move him to hex 0304), or "1B" (which would move him to hex 0404), or "1F" (which would move him to hex 0204). If he had plotted "TAC," the owning player would be able to turn the ship to face one of these hexes, but not enter it. However, he could make this maneuver at any time, and in either direction, as he sees fit during the course of the turn. Note, however, that only ONE such maneuver is permitted during each turn of the game.

**NOTE:** The ship could, later in the same turn, accelerate using (C12.0) and leave the hex; see (C5.531). See also (G7.93).

**(C5.12) IMPULSE POWER RESTRICTION:** A ship must spend one unit of impulse engine energy to make a sublight tactical maneuver. This energy must come from impulse engines. A ship which makes a sublight tactical maneuver cannot, during that turn, move using impulse power; see (C2.111). However, a ship can use impulse power (even reserve impulse power) for erratic maneuvers (C10.11) in addition to the point of impulse power used for movement or tactical maneuvers. See (P8.432) for using impulse TACs to maintain orbit.

**(C5.13) ZERO-ENERGY TURNS:** A ship which had no power allocated to any movement function for the entire turn (and which did not move under its own power for the entire turn) can make one tactical maneuver per turn without power cost. This TAC can only be made on Impulse #32. (This represents the nominal effect of the ship's attitude thrusters, which are normally used for docking purposes. They operate on puffs of compressed gas, as earlier spacecraft did.) This does not count as a TAC requiring orbital stabilization; see (P8.433).

This maneuver cannot be combined with normal tactical maneuvers during the same game turn.

A shuttle which does not move under its own power for an entire turn may make a zero energy turn of up to 180° on the last impulse of that turn.



**(C5.2) WARP TACTICAL MANEUVERS**

In certain tactical situations a ship's captain may decide that he does not want to change his position for the next turn, but that he does wish to maintain warp maneuverability.

**(C5.21) PROCEDURE:** Tactical warp maneuvers (also known as warp tactical maneuvers or warp-tacs) are performed much like sublight tactical maneuvers. The ship remains in the same hex for the entire turn, but can turn 60° (several times) under certain circumstances. [The ship could leave the hex later during the turn by making a speed change under (C12.0) in Advanced Missions.]

**(C5.22) ENERGY COST:** A given ship may make up to four tactical warp maneuvers during a given turn. Each requires the same energy it would have to move one hex (i.e., warp engine power).

**(C5.221)** A ship can allocate warp engine power for up to four warp maneuvers and may, during the turn, perform additional maneuvers (up to the overall limit of four) with reserve warp engine power (up to the limit of available reserve power). Note that the total number of warp tactical maneuvers with both allocated and reserve power is four, not eight. Note that a unit does not have to be doing tactical maneuvers in order to use reserve power for this purpose, see (C5.5).

**(C5.222)** See (C5.51) in the case of emergency deceleration.

**(C5.223)** Impulse energy may not be used to perform tactical warp maneuvers; it can be used for sublight tactical maneuvers (C5.2).

**(C5.224)** There are exceptions to the limit on the number of warp tactical maneuvers a ship can make. See (G21.124) for poor crews, (G21.224) for outstanding crews, (C13.926) for two ships docked together, (G2.22) for an uncontrolled ship, (G11.21) computer ships.

**(C5.23) OPERATIONS:** Tactical maneuvers are resolved on the "speed 4" column regardless of the number of warp tactical maneuvers paid for or any speed changes the ship may have made. In the case of a ship that halted during the turn, see (C5.532).

**(C5.231)** A ship using tactical warp maneuvers is assumed to have earned its first such maneuver (if power was allocated; earned the right to buy with reserve warp engine power if not allocated) on the second impulse of the turn. Thereafter, it earns an additional maneuver (or the right to buy one) each time it is scheduled to "move" by the impulse chart, except on the last impulse of the turn. Thus, a ship scheduled to make four tactical maneuvers would earn one on Impulses #2, #8, #16, and #24.

**(C5.232)** A given ship may have only one "earned" and unused tactical warp maneuver at any one time. If the movement chart calls for the ship to move (i.e., earn another maneuver) and it has not used the last one it earned, the new one is lost and the ship still has only one "earned" maneuver. A ship which has one TAC allocated can expend that TAC on any impulse in a given turn from Impulse #2 to Impulse #32. A ship that has allocated for two TACs can use the first one on any impulse from #2 to #23, but loses the first one on Impulse #23 if it has not been used. If the first of two TACs is used prior to Impulse #8, the second TAC is available from Impulse #8 until the end of the turn. This same procedure is used if the ship allocates for three TACs or four TACs. A ship might execute one or more allocated TACs, and then purchase one or more from reserve warp engine power later in the turn, but can never have more than one TAC available in any eight impulse period or use more than four warp TACs in a given turn. Exception: Outstanding Crews (C5.233).

**(C5.233)** If a ship has an outstanding crew, it will be necessary to use the "speed 6" column for that ship. This fact is not noted elsewhere in (C5.0) to avoid having numerous notations of "speed 6 if the ship has an outstanding crew (G21.224)" cluttering the rules. A poor crew would still use the "speed four" column but would skip the #1 and #3 entries.

**(C5.3) COMBINATION OF WARP AND SUBLIGHT TACTICAL MANEUVERS**

**(C5.31) PROCEDURE:** A ship may use tactical warp maneuvers and sublight tactical maneuvers during the same turn (but NOT during the same impulse). In this case, the warp-tac maneuvers would be made as per (C5.23) and the sublight-tac could be made at any point in the turn when it was eligible.

**(C5.32) SPEED COLUMN:** Four warp-tacs and one sublight-tac would not be resolved on the speed-5 column, but on the speed-4 column with one extra (sublight) tactical maneuver.

**(C5.33) MAXIMUM:** The maximum number of tactical maneuvers (5 for most ships, 7 for outstanding crews, 3 for poor crews) cannot be exceeded during a turn under any circumstances. A ship cannot, for example, perform tactical maneuvers, then use emergency deceleration, then claim the right to do more such maneuvers under (C5.51).

**(C5.4) DATA ON TACTICAL MANEUVERS**

**(C5.41) SPEED ZERO:** As tactical maneuvers are performed only by units at a practical speed (C2.411) of zero, the ship will be severely restricted in the speed it can move during future turns by the acceleration limits.

Tactical maneuvers should be considered a means of making any time you must spend at speed zero less unbearable, rather than a good reason to bring your ship to a stop.

**(C5.42) PLOTTED MOVEMENT:** If using plotted movement (C1.32), the direction and impulses of tactical maneuvers need not be plotted but can be made during the turn at the option of the owning player. See also (C3.433).

**(C5.43) NON-SHIP UNITS:** Fighters may make warp tactical maneuvers (J4.11) but cannot make sublight tactical maneuvers.

Shuttles (other than fighters) and seeking weapons cannot make tactical maneuvers of either type. (Note: The MRS and SWAC shuttles are not fighters but can use tactical maneuvers.)

Bases, a type of ship, cannot make tactical maneuvers at all.

Most monsters can make tactical maneuvers (although some do not need to as they can move and fire in any direction).

**(C5.44) MOVEMENT:** Tactical maneuvers are not movement per se and will not result in asteroid damage or mine detonations. They do count, however, as part of the maneuver rate for speed restrictions when using a cloak or wild weasel (C2.42).

**(C5.441)** The number of tactical warp maneuvers actually paid for is not announced, as the controller in (C5.23) is using speed 4 regardless of the actual number of such maneuvers paid for. The player need not announce if he has any tactical maneuvers paid for.

**(C5.442)** The fact that a ship is making a sublight tactical or warp tactical maneuver is only announced when the maneuver is actually made. A ship is not required to announce, during the Speed Declaration Step, if it has the power allocated for such a maneuver. The controller will announce the movement impulses for speed 4 in any case when a ship is at speed 0, or when required by (C5.532). If the controller wants to be helpful, he could warn such ships one impulse in advance that they may be about to lose an earned Tac under (C5.232).

**(C5.443)** Upon making such a maneuver, the player is not required to announce if the power was from allocated or reserve energy, but must announce if it was a warp or sublight Tac.

**(C5.5) COMBINING TACTICAL MANEUVERS AND MOVEMENT**

It is possible, by using the Emergency Deceleration (C8.0) or Changing Speed in Mid-Turn (C12.0) rules to use movement and tactical maneuvers during the same game turn.

**(C5.51) EMERGENCY DECELERATION:** After coming to a halt with emergency deceleration, a ship can use tactical maneuvers; see (C5.53). These can only be paid for with reserve warp or reserve impulse power. They cannot be paid for during Energy Allocation because a unit cannot plot movement in anticipation of emergency deceleration (C8.25) and must have a legal speed plot for the entire turn (C1.34).

If a moving ship had allocated energy for tactical maneuvers [possible with a plotted speed change to zero under (C12.0) Speed Changes] and then used emergency deceleration, the energy allocated for tactical maneuvers would be transferred to the shields along with all other unexpended movement energy as in (C8.1).

**(C5.52) TEMPORARY HALTS:** If at speed zero (C5.41) during part of a turn [using (C12.0) speed changes], the ship can make tactical maneuvers during that period; see (C5.53). These must be paid for during energy allocation or made with reserve warp engine or reserve impulse power. A ship could plot a low speed in the first part of a turn, then speed zero with tactical maneuvers in the middle of the turn, followed by movement at a low speed (due to acceleration limits) during the final portion of the turn.

If using plotted movement, see restrictions under (C3.443).

**(C5.53) USING TACTICAL MANEUVERS:** In either case (C5.51) or (C5.52), the ship can use sublight and/or warp tactical maneuvers within the following restrictions.

**(C5.531) SUBLIGHT** maneuvers cannot be made on the impulse after the ship comes to a halt. Because only one point of impulse power can be used for any movement function except as provided in (C2.111), a ship will not have reserve impulse power if it used any impulse power for normal movement during the turn. See (P8.43) when using impulse power for orbital stabilization.

**(C5.532) WARP:** The ship "earns" (or earns the right to buy with reserve warp engine power) its tactical maneuvers on the speed 4 column as per (C5.23), but cannot make the first such maneuver until 4 impulses after coming to a halt. A ship which stops in mid-turn by ED (Emergency Deceleration) can purchase TACs, through reserve warp power within the limits of the TAC rules, e.g., a ship which completes ED on Impulse #21 could only purchase one TAC (i.e., the one available from Impulse #24 to the end of the turn) because of the four impulse delay.

**(C5.54) HIGH ENERGY TURNS:** The ship could also use an HET if it had been previously allocated or if reserve power is available. An HET could be done on the impulse after stopping or on any subsequent impulse (within the HET rules). See (C6.35) and (C8.42).

## (C6.0) HIGH ENERGY TURNS (*Advanced*)

All warp-powered ships are capable of attempting "high energy" turns. Basically, such a turn requires the application of warp energy force to bring the ship onto a new heading with a "snap turn." These maneuvers are dangerous, however, and if improperly performed (and sometimes even if they are properly performed) can result in serious damage to the ship.

**NOTE:** While these rules are written for "ships" (which include PFs and Interceptors, but in this case does not include bases), certain "non-ship units" can use a limited or special version of the HET rules. See (C6.4).

### (C6.1) PROCEDURE

The effect of a high energy turn is to, at the point for which it is plotted, turn the ship TO FACE ANY ADJACENT HEX regardless of whether or not it has satisfied its turn mode. [See (C6.39) for a limitation.]

High energy turns may be made during the Movement Segment of any impulse, regardless of whether or not the ship is scheduled to move, within the restrictions of (C6.3), and subject to a possible breakdown (C6.5).

**(C6.11) FREE MOVEMENT:** If using free movement (C1.31), the player can use an HET at any point during the turn so long as power is available (C6.22). A ship that allocates energy for an HET (when using free movement) is not required to expend it. Any unused energy is lost.

**(C6.12) PLOTTED MOVEMENT:** If using plotted movement (C1.32), the specific impulse on which the HET will be performed must be plotted in advance. If the ship performs emergency deceleration, the HET can be conducted on any impulse after the ship stops.

**EXAMPLE:** Movement plot for speed 21: 7A, 6B, HET/21/E, 8E. This would indicate that on Impulse #21, after the first 13 impulses of movement had been completed, a high energy turn would be used to change direction 180°.

**(C6.13) HETs ARE NOT MOVEMENT:** The act of making an HET is not movement and is not included within the practical speed (C2.411) or effective speed (C2.412). It will not set off mines or cause asteroid damage. It does not in itself move the ship into the next hex. HETs are not movement, but do count as part of the maneuver rate; see (C2.42).

### (C6.2) POWER FOR HIGH ENERGY TURNS

**(C6.21) COST:** Each high energy turn requires warp energy equal to five hexes of movement. The cost must be paid in addition to any energy used for movement.

Exceptions: Poor Crews (G21.122), Outstanding Crews (G21.222).

**(C6.22) SOURCE:** Energy for HETs must come from warp engines (or reserve warp engine power); it cannot come from AWRs. See (H7.48) and (H7.6). See (C12.38).

### (C6.3) RESTRICTIONS AND CONDITIONS

**(C6.31) ACCELERATION:** High energy turns do not affect acceleration and are not affected by it. They are not part of the practical speed (C2.411).

**(C6.32) TURN MODE:** After a high energy turn, turn mode calculations (for normal turns) and sideslips must begin again, starting in the hex in which the HET was made (i.e., an HET resets the turn and sideslip modes to zero). A ship need not have fulfilled its turn mode to make an HET. See (C3.45).

**(C6.33) IMPULSES:** A ship may make a high energy turn during any impulse whether it is scheduled to move or not. If the HET is made during an impulse in which the ship is scheduled to move, the HET is resolved first (turning the ship to a new facing and resetting its turn and slip modes), and then movement is executed. HETs are conducted at whatever point in the Order of Precedence (C1.313) that the unit conducts normal movement. Units at speed zero HET first within each category.

**(C6.34) NUMBER:** Subject to available energy and the other rules [e.g., (C6.36) limits most ships to four], a ship may make any number of HETs during any given turn. See also (C6.4) for non-ship units.

**(C6.35) COMBINATION WITH TACs:** A ship may use high energy turns on the same turn as tactical maneuvers; see (C5.54). This can be done on the same impulse.

**(C6.36) SEQUENCE:** An HET may not be performed within 1/4 turn of a previous HET or Quick Reverse; see (C3.62).

**(C6.37) HET NOT ALLOWED:** No unit may make an HET on the first impulse of the turn, while docked (C13.924), while docking (C13.16), while undocking (C13.23), or while part of a pinwheel (C14.12), or if uncontrolled (G2.212). Exception (F2.135).

**(C6.38) POST-HET RESTRICTIONS:** During the impulse that a ship performs an HET and for 1/8 of a turn (4 impulses) thereafter, the ship cannot: dock with another unit, be docked by another unit, launch or recover PFs, launch or land shuttles (including those on a seeking course), lay mines from a bay or rack, or launch or recover satellite ships.

Exception: units escaping a doomed ship (D21.4).

**EXAMPLE:** A ship that HETs on Impulse #15 is under these restrictions until the beginning of the movement segment of Impulse #20.

**(C6.39) 180° LIMIT:** No HET can exceed 180°. (This may seem to be a meaningless rule, but is required to prevent a technical loophole in the seeking weapons rules.) See (G7.55).

**(C6.4) NON-SHIP UNITS**

Some non-ship units can make high energy turns.

**(C6.41) SEEKING WEAPONS:** Seeking weapons may perform HETs; see (F2.13). [Note that (C6.39) prevents a seeking weapon from making a meaningless HET to waste time en route to the target.]

**(C6.42) FIGHTERS:** Fighters may make one (and only one) HET per turn, but never roll for breakdown. Non-fighter shuttles cannot perform HETs unless specifically allowed this capability in their own rules section.

**(C6.5) BREAKDOWN**

There is a considerable possibility that a high energy turn could result in a breakdown. This is an event a bit more disastrous than having the chessboard slide off of the captain's desk and somewhat (but only a little) less catastrophic than having the engines fall off.

**(C6.51) PROCEDURE:** Whenever a ship performs an HET, roll a single die to determine if the ship has suffered a breakdown. If the die roll is within the numbers specified in the ship's adjusted breakdown rating, the ship has suffered a breakdown.

**(C6.511)** There are several possible modifications to this die roll, including crew quality (G21.121) and (G21.221), first use (C6.52), tractors (G7.322), erratic maneuver (C10.55), previous breakdowns (C6.544), Legendary Navigators (G22.86), and others so specified in their respective rules. Any modifiers applied to the breakdown rating (etc.) also apply to the possibility of pod separation (C6.56).

**(C6.512)** The die roll is made after the ship changes facing but before it moves into the next hex.

**(C6.513)** A unit cannot voluntarily break down.

**(C6.514) DOCKED SHIPS** (C13.948) and PFs on tow-bars (K1.25) have special conditions when they suffer a breakdown.

**EXAMPLE:** The breakdown rating for a Klingon D7 is 5-6. Whenever the ship makes an HET, roll a die. If the result is 5 or 6 (after certain adjustments), the ship has suffered a breakdown.

**(C6.52) FIRST-USE ADJUSTMENT TO BREAKDOWN DIE ROLL:** On the first HET during each scenario, two is subtracted from the die roll when determining the possibility of breakdown. Note that this adjustment is once per SCENARIO and NOT once per TURN. Each ship can do this once, not each fleet.

**(C6.521)** Nimble ships (C11.0) and Orion ships (G15.0) subtract two from the die roll of the first and second HET each scenario. Nimble Orion ships do not get both benefits.

PFs, which are nimble, get only one bonus, not two (K1.23). Orion PFs act as PFs, not as Orion ships. Note that Orion PFs do not get a double nimble bonus, but only a single bonus (K1.23).

**(C6.522)** Freighters, naval auxiliaries built on freighter hulls, warp-powered booms and saucers, auxiliary carriers, auxiliary cruisers, Q-ships, and all crippled ships (S2.41) do not receive an adjustment to the breakdown die roll. Certain other ships also have this limitation; if so, it will be listed in the ship specifications.

**(C6.523)** There is no adjustment to the breakdown rating for speed, but the speed of the ship does affect the amount of damage that results from a breakdown; see (C6.562).

**(C6.524)** This bonus cannot be used for a quick reverse (C3.63).

**(C6.53) ASSIGNMENT OF BREAKDOWN RATINGS:** Each ship is assigned a breakdown rating on the MASTER SHIP CHART. These are also shown in the Ship Data Table on each SSD.

**(C6.54) EFFECTS OF BREAKDOWN:** Whenever a ship suffers a breakdown, it suffers the following effects:

**(C6.541)** The ship immediately stops [unless it "tumbles" (C6.55)]. Roll one die and face the ship in the resulting direction. All allocated movement energy (including EM, tactical maneuvers, and HETs) is lost. The ship may not move (including HETs and Tacs) for 16 impulses after the impulse in which it broke down. This is known as the "post-breakdown period." After this period, the ship could resume normal movement (e.g., it could do a tactical maneuver with reserve power).

**(C6.5411)** If the post-breakdown period extends into the next turn, the ship remains at speed zero for the required first several

impulses of the next turn, then accelerates from that point, paying for a full turn of movement even though it does not receive part of it. [If using (C12.0), the ship pays, for this non-moving period, at the rate for the highest speed used during that turn.]

**(C6.5412)** If this post-breakdown period does not extend to the end of the turn, the ship could begin moving with reserve power (C12.24) after the 16 impulses are over.

**(C6.542)** A ship which suffers a breakdown receives the following damage as a result of the breakdown:

**(C6.5421)** One third of the crew units (including at least 1/4 of the boarding parties and 1/4 of the deck crews) are killed. (This is based on the number of such units on board at the time of breakdown. Round fractions down when calculating the losses.) The full crew unit casualties must be scored, but cannot include the last two crew units (G9.22). Note that in the case of a ship with few crew units and many boarding parties (e.g., a troop ship) the ship may lose no actual crewmen but dozens of boarding parties will die like dogs. Additional crew losses may result from the resolution of internal damage. Also, 1/4 of any enemy boarding parties on the ship are lost; they do not count toward the requirement for friendly crew or BP losses. Assigned guards are not "knocked out" but will be killed if the box they are guarding is destroyed (D7.832).

**(C6.5422)** Every fifth warp engine box is destroyed (round fractions down when calculating these losses). This is distributed as evenly as possible between the ship's engines; any odd points are distributed by the owning player at his option.

**(C6.5423)** The ship suffers two interior damage points, distributed randomly and immediately by the DAMAGE ALLOCATION CHART (D4.21). This damage (as well as that resulting from tumbling and pod separation) is resolved as a single volley; the phaser directional restriction (D4.321) does not apply.

**(C6.543)** Any repairs (by any means, on or by the unit which broke down) are aborted. Accumulated repair points for incomplete repairs are lost immediately; they cannot be converted into hasty repairs.

**(C6.544)** Each breakdown reduces the breakdown rating by one for the remainder of the scenario. For example, 4-6 becomes 3-6 (and possibly 2-6 and 1-6 later, although it can never get worse than 1-6). Nimble ships lose all benefits of that status (C11.2) for the remainder of the scenario after a breakdown.

**(C6.545)** All stasis fields (G16.311) and expanding spheres (G23.0) generated by the ship suffering the breakdown are lost (deactivated) immediately. All tractor beams (G7.0) generated by the ship suffering the breakdown are released; those attached to the ship by other units remain attached except as per (C6.553).

**(C6.546)** No deck crew activities (J4.8) can be performed or completed on that turn. Any activities begun on the turn of the breakdown are cancelled and will have to be started over. One half of the boarding parties (on each side) that were on the ship at the time of the breakdown cannot participate in combat (or function as guards) during the post-breakdown period or in the Boarding Party Combat Step at the end of the turn on which the ship broke down. (They are still present and would have to be eliminated to capture the ship; they simply cannot fight back.) Boarding parties transported aboard after the breakdown function normally.

**(C6.547)** A ship suffering a breakdown is under the following restrictions for the subsequent eight impulses (even if this extends into the next turn):

**(C6.5471)** No weapons (see Annex #7D) may be fired.

**(C6.5472)** No shuttles, PFs, satellite ships, or fighters may be launched or recovered, except as per (D21.4). Sections cannot be separated (G12.0).

**(C6.5473)** No seeking weapons may be launched. [Plasma torpedoes may be launched using (FP1.7) during this time, but only on the 8th impulse after destruction of the launcher.] See (FP1.14).

**(C6.5474)** No transporters or tractor beams can be used.

**(C6.548)** If a ship is docked inside a larger ship, and the larger ship suffers a breakdown, the ship inside also suffers the full effects of the breakdown, which are resolved independently. This does not apply to shuttles, except that shuttles on a balcony are destroyed. This does not apply to PFs.

**(C6.549)** Breakdown does not affect a cloaking device. [If using (D22.0), the resulting damage may reduce power below that required to operate the cloak.]

**NOTE:** While it is not a formal rule, experience has shown that any ship which breaks down during a battle probably will not survive that battle.

**(C6.55) TUMBLING AS A RESULT OF A BREAKDOWN (Commander's Level):** In the event of a breakdown, roll one die. If the result is a "1," the ship has begun "tumbling" and suffers the following effects:

**(C6.551)** The ship CONTINUES (for the duration of the post-breakdown period) moving in the direction, and at the speed, that it was moving BEFORE ATTEMPTING the HET regardless of its facing. Exception: (C6.563). See (P2.435) in the event the unit tumbles into a planet hex. A ship cannot tumble off of a fixed map; if it is about to do so it will stop in the last hex.

**(C6.5511)** Every impulse for the remainder of the post-breakdown period, during the Final Functions Stage of the Activity Segment, roll one die and turn the ship to face (C1.21) in the indicated direction. (In all probability, the ship will be facing in a new direction almost every impulse.) Also note that in this case facing will have nothing to do with movement.

**(C6.5512)** Any previously plotted speed changes (C12.0) during the period of tumbling are ignored. Any effects of (D22.0) on the ship's speed are ignored.

**(C6.5513)** Damage due to mines, ESGs, webs, asteroids, and other terrain effects is based on the speed during tumbling and on the shield determined by the die roll. This is an exception to various rules on the "leading" shields of a unit taking such damage.

**(C6.552)** Ships that are tumbling cannot fire weapons or take any other action. There are no exceptions to this rule, not even Q-ships (R1.7).

**(C6.553)** Ships that are tumbling are considered to be using erratic maneuvering (C10.0). (If you do not have Advanced Missions, this can be simulated by adding 4 ECM points to the tumbling ship.) If the ship was held in a tractor beam, the beam is released by the violent gyrations of the ship. A tumbling ship cannot be tractorred.

**(C6.554)** At the end of the post-breakdown period, the ship comes to a stop with a speed of 0 and its final facing is determined by die roll on the last impulse; see (C6.5511).

**(C6.555)** Roll one die and score extra crew units killed AND extra points of internal damage equal to the result. This cannot kill the last two crew units; see (G9.22). This is in addition to the damage from the breakdown itself (C6.542) and is combined with that damage into a single volley. This additional damage occurs only one time, not on every subsequent impulse. PFs are exempted from this extra damage.

**(C6.556)** A ship that tumbles into an atmosphere hex without a planetary surface comes to a stop immediately. It must roll for breakdown again upon entry to the hex, but cannot tumble.

If there is a planetary surface in the hex, the ship crashes, i.e., is destroyed without any chance of survivors; see (P2.435).

**(C6.557)** A tumbling ship cannot use emergency deceleration.

**(C6.558)** During every impulse of tumbling, (C6.546) and (C6.547) are in effect. See also (FP1.14).

**(C6.56) EFFECT OF BREAKDOWN ON TUGS:** The ungainly transport tugs (including Light Tactical Transports), with their fragile pods, suffer more damage as a result of breakdown than most ships.

This rule does not apply to units (PFs, shuttles) held on mechs-links; it applies only to pods/pallets/packs, although resulting damage could be scored on PFs attached to a pod that breaks down. This applies to any ship carrying a real pallet, cargo pack, or pod (not a pseudo pod). It does not include "internal" cargo (on the SSD of the ship, not part of the pod), such as the Hydran Tug or the Romulan SkyHawk-H.

**(C6.561)** In the event that a tug carrying pods suffers a breakdown, roll again for each pod. If the result (with all modifiers used in the original die roll) is within the breakdown range of the tug (before this breakdown), the pod has separated.

**(C6.562)** If a pod separates, immediately apply one point of damage (directly by the DAC) to the tug (not including still-attached pods) and one to the pod (and one point to any still-attached pod) for each unit of the tug's practical speed (before the breakdown).

**(C6.563)** The pod is detached from the tug and remains in that hex; the tug tumbles (C6.55). The pod does not tumble. Any seeking weapons targeted on the tug accept the pod as their target. If two pods separate, arbitrarily assign one pod the numbers 1-3 and the

other the numbers 4-6 and roll a die for each weapon, with the weapon accepting the corresponding pod as its target.

**(C6.564)** Pod docking arrangements have an effect on pod separation.

**(C6.5641)** In the case of a Federation tug (which attaches the second pod to the first one), roll for each pod. Separation of the first (i.e., forward) pod means the loss of both. The two pods then separate from each other without further damage as a result of that separation.

**(C6.5642)** In the case of tugs with side-by-side mounting (G14.43), if only one pod separates the tug tumbles with the other pod still attached. After the tug stops, it will have to drop (and could reattach) the pod before resuming operations. It could also drop the pod, tow it by tractor back to the point where the first pod was dropped, and then reattach both.

**(C6.565)** If a separated pod is manned, roll one die and score this number of crew casualties to the crew and passengers of the pod. This is in addition to (C6.542), but cannot kill the last two crew units (G9.22).

## (C7.0) DISENGAGEMENT

In some cases a starship captain may find himself in a situation that he (or rather his ship) cannot handle. In these cases, the only thing to do is to leave. Combat at extreme speeds (those over 31 hexes per turn) is virtually impossible due to the tremendous amounts of energy required to simply move the ship at those speeds and the inability of the weapons tracking systems to function accurately.

In cases where one starship captain simply accelerates his ship out of the area, the other captain will not normally follow (at least not closely) as he may be led into a trap. In game terms, this is disengagement.

There are four means of disengagement: acceleration, separation, sublight evasion, and automatic.

Bases and pinwheels (C14.14) cannot disengage.

### (C7.1) DISENGAGEMENT BY ACCELERATION

**(C7.11) PROCEDURE:** On a given game turn, the starship wishing to disengage by acceleration must move (for the entire turn) at the maximum possible practical speed which it can, as restricted by available engine power (which may have been reduced by combat) and the game imposed speed limit of 31. At the end of that turn, if the starship in question still has total warp power available equal to either 50% of his original warp power (rounding fractions up) or 15 points of warp power, whichever is lower, the owning player simply announces that he is "disengaging." His ship is then removed from the board and presumed to return to its nearest base. If the disengaging ship is the only unit (on that side) of the scenario, the scenario is over.

**EXAMPLE:** A Klingon cruiser finds itself outnumbered by four Kzinti cruisers. The owning player elects to disengage. He moves one turn at a speed of 24 (which is the maximum he could reach because of acceleration restrictions) and on the next turn accelerate further to 29 (he cannot go 31 as he has taken two engine hits). During that turn, the Klingon ship is badly damaged, and warp engine power is reduced to 15. The ship may still break off the action by disengaging since 15 is 50% of the original 30 warp engine boxes. If the warp engines had been reduced to 14 or fewer factors, the Klingon could not disengage and would likely have been destroyed.

**(C7.12) RESTRICTIONS:** The following restrictions apply to disengagement by acceleration.

**(C7.121)** The conditions of (C7.11) must be fulfilled based on engine power available at the beginning of the turn. A Federation CA (movement cost = 1), for example, has 30 warp engine boxes at the beginning of the turn but cannot move faster than 24 due to acceleration. It is, during that turn, reduced to 24 (or fewer) engine boxes but CANNOT disengage that turn. It must move another turn at what is now its maximum speed (24) before disengaging. The reason for this is that a ship must "prepare" for the transition to high trans-light speeds, and such preparations must be timed very closely. A ship not moving at its maximum speed would not know for sure that enemy fire will reduce its maximum speed to its current speed and could not make the preparations.

**(C7.122)** If held in an enemy tractor beam, expending energy for movement (even if not actually moving) satisfies the requirement. The act of disengaging breaks the tractor (G7.28).

**(C7.123)** A ship can only disengage by acceleration while moving forward. A ship cannot disengage by acceleration if the area directly ahead is blocking terrain (asteroids, minefield, large planet, etc.). To qualify, the minefield would have to be a formal minefield placed before the scenario began; mines laid during a scenario would not count. The planet would have to be large enough (and/or the ship close enough) that the ship could not avoid the planet with sideslips if the ship continued moving without turning.

**(C7.124)** The term "maximum possible speed" as used in the first sentence of (C7.11) does not include any energy spent for life support, shields (not reinforcement), or fire control. The ship may make these expenditures and then calculate its maximum speed based on the remaining energy. Note that this does not apply to calculating the ship's original movement-capable warp power as per (C7.11), which requires 50% (or 15 boxes) to be available (i.e., undestroyed, even if some of this was paying for the above non-movement items). Within the restrictions of this rule, the ship may fire any weapons it has charged (including the launching and guiding of seeking weapons), or had the excess, usually non-movement, power to arm while it was attempting to accelerate away.

**(C7.125)** A ship held in web must break out of the web before it can disengage (G10.58). This breakout can be on the turn of disengagement.

**(C7.13) FIGHTER DISENGAGEMENT BY ACCELERATION:** Fighters (not non-fighter shuttles, but including MRS and SWAC shuttles) can disengage by acceleration within the restrictions and conditions given here. See (J1.71) and (J1.72).

**(C7.131)** The fighter must move for an entire turn at its maximum possible speed. It cannot fire, launch, or control any weapons during this turn. Note that fighter EW rules (EWFs, Pods, and landing from the carrier) and chaff packs function normally during this period.

**(C7.132)** At the end of the turn (C7.131), if the fighter is not crippled, the fighter may be declared (by its owner) to have disengaged.

**(C7.133)** The fighter must fulfill the conditions of (C7.123).

**(C7.134)** A fighter held in an enemy tractor beam cannot disengage.

### **(C7.2) DISENGAGEMENT BY SEPARATION**

**(C7.21) PROCEDURE:** If, during the Lock-On Stage of any impulse, a given unit is not within 50 hexes (effective range) of any enemy ship, then that unit may, at the owning player's discretion, be deemed to have disengaged. See (C7.23).

An enemy unit held in a tractor beam (i.e., a smaller unit being dragged off the map to be captured) does not count for this purpose if there are other enemy units in the scenario which are not in the same condition. This means that you can get away with hauling off a captured ship if no one else is around to interfere with you.

Note that as cloak increases effective range, a cloaked ship could disengage at a shorter true range.

**(C7.22) SEEKING WEAPONS:** If seeking weapons are on the map targeted on the unit, the unit cannot disengage by separation until those weapons are resolved (i.e., run out of endurance, lose tracking, are destroyed, etc.). If there is no possibility of the seeking weapon catching the escaping unit (i.e., escaping unit is faster, or the weapon is faster but does not have the endurance to close the range), this does not apply.

**(C7.23) SCOUTS:** A unit must be more than 75 hexes (effective range) from an enemy scout ship (with operating and unblinded special sensors) in order to disengage by separation (in addition to the other requirements).

**(C7.24) TRACTOR BEAMS:** Disengagement by separation does not break tractor beam links. Any units which the disengaging unit is holding in tractor beams remain held.

**(C7.25) FIXED MAP:** Some scenarios used fixed maps and include a rule stating that any unit which leaves the map has disengaged and cannot return. This is a form of disengagement by separation, but is not subject to the conditions of (C7.21) through (C7.23).

**(C7.26) OTHER PURSUING UNITS:** The unit attempting to disengage by separation must be more than 35 hexes from enemy PFs or manned shuttles.

### **(C7.3) DISENGAGEMENT BY SUBLIGHT EVASION**

Ships without warp engines (including sublight ships such as the Warbird, separated booms from Klingon ships, separated saucers from Federation ships, ships that have dropped their warp engines, etc.) can disengage by sublight separation. Note that only dropping the warp engines (G12.6), not the mere act of turning them off, counts for this purpose. Destroyed warp engines must be dropped in order to sublight disengage.

**(C7.31) PROCEDURE:** The player owning a ship wishing to disengage by this method rolls one die during the Final Activity Phase and makes the adjustments listed below. If the adjusted result is "3" or less, the ship has successfully disengaged.

**(C7.32) ADJUSTMENTS:** The following adjustments to the die roll are made:

-1 for every friendly ship (not shuttle) within 35 hexes.

+1 for every uncrippled enemy ship (not shuttle) within 15 hexes.

Remember that "ship" includes bases and PFs, while "shuttle" includes fighters.

**(C7.33) IMPULSE REQUIREMENT:** A ship without any impulse engines cannot disengage by sublight evasion. This is one reason why Klingon booms have impulse engines that can be protected with circuit breakers (G12.71), but note that those engines (H3.5) cannot be used for movement while the boom is attached to the hull.

**(C7.34) TIME OF ATTEMPT:** This can only be attempted once per turn at the end of the Final Activity Phase.

**(C7.35) TRACTOR BEAMS:** Disengagement by evasion does not break tractor beam links. If the ship attempting to disengage is held in a tractor beam, it cannot disengage by evasion. A ship attempting to disengage by evasion must drop any of its own tractor beams (to reduce its electronic signature on enemy scanners).

**(C7.36) BLACK HOLES:** If the unit attempting sublight evasion is within 30 hexes of a black hole, it cannot escape and is deemed destroyed if disengagement is declared.

**(C7.37) SEEKING WEAPONS** treat a ship that disengages in this manner as a "destroyed target" and become inert.

### **(C7.4) AUTOMATIC DISENGAGEMENT**

In certain circumstances or scenarios, a ship may be designated by the rules to disengage "automatically." One case would be a Klingon ship in a monster scenario, which automatically disengages after a successful mutiny. In this procedure, the ship is simply taken from the board and considered to have disengaged.

This form of disengagement is specified in some monster scenarios, where the monster has no desire to pursue the ship.

### **(C7.5) DISENGAGEMENT CONDITIONS AND RESTRICTIONS**

In cases of disengagement, there may be ongoing situations that must be resolved, even if this means continuing the scenario past the point at which it "ended."

**(C7.51) BOARDING PARTIES** on board an enemy ship that is disengaging must continue to fight until they capture the ship or are destroyed. For humanitarian or simply practical considerations, boarding parties in a hopeless situation may be ordered to surrender by the controlling player. Should they capture the ship, it is presumed that they force it to stop and their own vessels catch up.

In a similar manner, boarding parties on an enemy ship that are left behind when their own ship disengages may surrender or fight on

to victory or death. If they capture the ship, they operate under (D7.5).

If using (D16.0), see (D16.82) and (D16.83).

**(C7.52) SHUTTLECRAFT LEFT BEHIND** by a disengaging ship may attempt to escape using sublight evasion (C7.3). Fighters, MRS, and SWACS can use (C7.13).

**(C7.53) SEEKING WEAPONS** targeted on a disengaging unit [except one disengaging by separation, (C7.22)] lose their tracking and cannot pursue it (if it successfully disengaged). Seeking weapons targeted on units remaining behind must be resolved before the scenario can end. Note that if the unit controlling a seeking weapon is destroyed or disengages, the weapon is released (F3.4) and can be transferred (F3.5).

## **(C8.0) EMERGENCY DECELERATION** *(Advanced Rule)*

All ships may use emergency deceleration to bring themselves to a rapid stop. This might be done to avoid running into an obstacle (perhaps a previously unknown minefield or perhaps some other object after the ship has been displaced by Andromedans), to meet the low-speed requirements to launch a wild weasel, or to allow the ship to move quickly to a key position and then stop once it has reached it.

Early translations of the source data indicated that emergency deceleration was restricted to Federation ships. This information has now been found to be incorrect. While Federation ships first developed the maneuver, other races copied it shortly thereafter.

There are circumstances under which a ship normally able to use this maneuver cannot; e.g., (C8.26).

These rules are written for "ships" (which includes PFs but, in this case, not bases). Shuttles can use a form of emergency deceleration; see (J1.223) and (J4.13).

### **(C8.1) PROCEDURE**

**(C8.10) PROCEDURE:** During the Impulse Activity Segment of any impulse during any turn (at the appropriate step in the Sequence of Play), a player may announce his intention to use emergency deceleration for one or more of his ships.

**(C8.101)** At the end of the Movement Segment of the second subsequent impulse (including those in which the ship does not move), the ship stops and is subject to post-deceleration restrictions (C8.4).

**(C8.102)** All unused movement energy (including previously allocated tactical maneuvers but not previously allocated HETs) is calculated, and the amount is divided in half (drop fractions). This amount is added to the general shield reinforcement power or to specific shields by (C8.11); the rest is lost. Braking energy (C3.52) allocated but not yet used is treated as movement energy, i.e., half of the energy allocated becomes shield reinforcement and the rest is lost.

For purposes of this rule, any impulse power for normal movement is considered to have been the first point of power expended. Impulse power allocated for an unexpended tactical maneuver is treated as above, and if the ship has a movement cost other than 1.00 will require attention in (C8.112).

See (C8.23) for energy allocated to EM.

**EXAMPLE:** The Federation CC *Kongo* is moving at speed 16 when six Klingon drones are released from a scatter-pack shuttle which had been launched by the D7 *Antagonist*. Having no phasers that will be able to fire before the drones arrive, and having neither the speed to outrun the drones nor enough tractor beams to hold them at bay (obviously due to poor planning), Captain Kosnett decides to use a wild weasel to decoy the drones away from his ship. However, the *Kongo* is moving too fast to use a WW, and Kosnett orders emergency deceleration on Impulse #15. The *Kongo* moves on Impulse #16 and then, on Impulse #17 (after movement on that impulse), stops and launches the WW. The *Kongo* does not move when next called for on Impulse #18. There are 8 unused movement points (each costing one point of power). This translates into 4 points of shield reinforcement, which Kosnett assigns to the shield facing the *Antagonist*. Had he assigned these to general reinforcement, he

would have received only two points of shielding as general reinforcement costs two energy points per shield point.

If the drones had been released from a very close position, they might have been able to strike the *Kongo* on Impulse #17 (in the Movement Phase, before the WW could be launched as shuttle launch is later in the Sequence of Play). If Kosnett had a copy of Advanced Missions, he might have used two points of reserve power to accelerate to speed 17, because careful study of the Impulse Chart shows that while a ship moving at speed 16 does not move on Impulse #17, a ship moving at a speed of 17 does. This moves the ship one hex farther from the drones and gives it time to launch the WW before the drones arrive. In this case, there would still have been 8 unused movement points (resulting in 4 points added to the shield).

**(C8.11) SHIELDS:** The power added to the shields may be added to any one shield selected by the owning player or divided in any manner between the three shields of either group (forward shields group includes #6, #1, and #2; rear shields group includes #3, #4, and #5). It could not be divided between shields from both groups.

**(C8.111)** The energy released by emergency deceleration is not reserve power and is not treated as such. It can only be used for the shields as described in the rule.

**(C8.112)** Note specifically that this procedure is calculated in terms of power, and not with movement points or points of shield reinforcement. A ship with a movement cost of 1/2 would gain only half as much shield reinforcement as one with a movement cost of 1. (This assumes two ships at the same speed doing ED at the same point.)

**(C8.12) HETs:** Power allocated (but unused) for HETs is not translated into shield energy by the decel maneuver and remains available to the ship to use within the normal rules. The ship could make an HET during the deceleration period or the post-deceleration period (and before the end of the turn). See (C6.35) and (C5.54).

**(C8.13) ANDROMEDAN SHIPS** which use emergency deceleration simply lose the excess movement energy. It does not go to the panels or batteries. (Consider the implication for Terminators if it did!)

### **(C8.2) CONDITIONS AND REQUIREMENTS**

**(C8.21) STOPPING:** Emergency deceleration can only be used to stop. It cannot be used to simply reduce speed. A ship can declare Emergency Deceleration even while it is not moving in order to cancel planned acceleration under (C12.0).

**(C8.22) ATMOSPHERE:** Ships in an atmosphere can perform emergency deceleration if there is no other restriction. See (C8.414).

**(C8.23) ERRATIC MANEUVERS:** A ship using EM (C10.0) which subsequently uses emergency deceleration loses the effects of EM at the point when the ship stops and does not gain extra shielding for EM energy.

Energy allocated for EM but unused is lost at the time of emergency deceleration. See (C8.43) to begin EM after decelerating.

**(C8.24) POSITRON FLYWHEEL:** The use of emergency deceleration stops the positron flywheel; see (C9.23).

**(C8.25) CANNOT BE PLOTTED:** Emergency deceleration modifies an existing legal speed plot and cannot, itself, be plotted. Even if the player plans to use emergency deceleration and knows precisely when and where he will do so, he must still plot and allocate energy for a full turn of legal movement. See (C1.35) and (C12.12).

It is, for example, specifically illegal to pay for only five movement points, move at speed 31 for the first six impulses, and then use ED.

**(C8.26) TUMBLING SHIPS** (C6.557) cannot use emergency deceleration.

**(C8.27) STASIS FIELD GENERATORS** cannot be used within 8 impulses of stopping by emergency deceleration, even if this extends into the next turn; see (G16.312).

**(C8.28) DOCKING:** Ships which have decelerated cannot dock to a base during the deceleration and post-deceleration periods; see (C13.16).

**(C8.3) DECELERATION PERIOD**

The two-impulse period between the announcement of emergency deceleration and the actual stopping of the ship is known as the "deceleration period."

**(C8.31) MOVEMENT EFFECTS:** During the deceleration period, the ship continues to function in all ways as a ship moving at the original speed. It must follow its original speed plot (which might require it to speed up or slow down). It can turn and/or sideslip (so long as it satisfies its modes), accelerate with reserve power (C12.24), perform HETs or EM, etc.

**EXAMPLE:** A ship is moving at speed 20 and has a turn mode of 4. It has moved two hexes in this direction when it discovers (on Impulse #19) that there is a minefield directly ahead. The player declares emergency deceleration (on Impulse #19) so the ship will stop on Impulse #21 (and be at speed zero at the end of that Movement Segment). On Impulse #20 (and #21 for that matter), the ship is scheduled to move. The player argues that he should not be required to move since "logically" his ship is slowing down and has not actually moved 10,000 kilometers, but this is false logic as the ship is still moving at the original speed while it prepares for the very sudden deceleration that will take place on the next impulse. Failing to win that argument, the player now asserts that he should be allowed to turn even though he has not satisfied his turn mode because, since the ship is slowing down, the turn mode should "obviously" be lower. This is also incorrect; the turn mode is the same, and the ship cannot turn unless the turn mode is satisfied.

**(C8.32) OTHER EFFECTS:** Weapons and other systems (transporters, tractor beams, etc.) are unaffected except as may be provided within these rules.

**(C8.4) POST-DECELERATION PERIOD**

The 16 impulses following the stopping of the ship (not the announcement) constitute the "post-deceleration period." During this period, the ship is under certain restrictions.

**(C8.41) MOVEMENT:** The ship cannot move out of the hex it is in during the post-deceleration period. The ship is considered to be at a speed of zero during the entire post-deceleration period.

**(C8.411)** If the post-deceleration period is over before the current turn is completed, the ship could move out of the hex using reserve power to accelerate under (C12.24).

**(C8.412)** If this post-deceleration period extends into the next turn, the ship remains at zero speed for the required first several impulses of the next turn, then accelerates from that point, paying for a full turn of movement even though it does not receive part of it. [If using (C12.0), the ship pays, for this non-moving period, at the rate for the highest speed used during that turn, but cannot count it as a basis for future acceleration.] The unused movement energy from this period of the subsequent turn is treated as in (C8.102). Note that movement power that would normally be spent for movement during the post-deceleration period after an energy allocation phase is treated under (C8.102) during that subsequent turn and is converted to shield reinforcement.

**(C8.413)** After the post-deceleration period, the ship can reverse its direction without paying a braking cost because it has been at speed zero for more than the required time; see (C3.523) and (C12.37).

**(C8.414)** ED in atmosphere is normal except that the 1 point of movement power needed to fulfill (P2.80) is allowed.

**(C8.42) RESERVE POWER:** A ship that has used ED cannot, during the post-deceleration period, use reserve power to move.

Exception: see (C5.51) Tactical Maneuvers after Deceleration, (C5.54) for HET, and (C8.43) for erratic maneuvers.

**EXAMPLE:** If a ship declares emergency deceleration on Impulse #4, it comes to a stop on Impulse #6 during the Final Movement Actions Stage (6A4). The 16-impulse post-decel period then extends until the Final Movement Actions Stage (6A4) of Impulse #22, so the first chance the ship has to move out of the hex is Impulse #23.

**(C8.43) ERRATIC MANEUVERS:** A ship can begin erratic maneuvers (C10.0) with reserve power during the post-deceleration period within the limits of (C10.3).

**(C8.44) OTHER EFFECTS:** No other systems are affected except as specified by these rules. For example, the weapons can still be fired (although doing so would void a wild weasel, which is the most common reason for the maneuver).

**(C9.0) POSITRON FLYWHEEL (Optional)**

Scientists in the Federation (and all other races) have experimented with a concept known as the "positron flywheel effect." This is a method of storing warp movement momentum temporarily. If used by a starship, the effect is to allow the starship to increase speed much more rapidly after a temporary reduction of speed.

Despite billions of credits spent on research and development by the Federation, the positron flywheel never did work and its use in the game is considered experimental and only for the purpose of evaluating the potential effect if it had.

Only ships (not including PFs or bases in this case) can use the positron flywheel; other units cannot.

**NOTE:** This rule is officially classed as "experimental" and is not considered in balancing other rules. It should never be used in competitive gaming, at least not as a player-selected option.

**(C9.1) EFFECT**

**(C9.11) PROCEDURE:** A ship equipped with positron flywheel uses the fastest speed in the four previous turns as a basis for acceleration limits. For example:

Turn	1	2	3	4	5
Speed	21	4	4	8	0-31

Using the standard rules, the fastest that this starship could move on Turn #5 would be 18 hexes (assuming normal maneuver limits for a typical starship). Using the positron flywheel effect, it could use the speed on Turn #1 (within the last four turns) as its base and accelerate to a speed of 42. (Note, however, that a speed of 31 is the maximum allowed in the game so the full benefit of this device could not be felt, but even 31 is better than 18.)

When using mid-turn speed changes (C12.0), the ship must be moving at a given speed for at least 8 consecutive impulses to use that speed as a basis for future accelerations under the flywheel. (The flywheel has to build up to the ship's speed.)

**(C9.12) PRACTICAL SPEED:** The positron flywheel is based on the practical speed (C2.411). Functions such as high energy turns, tactical maneuvers, erratic maneuvering, etc., are not counted as part of the speed for purposes of positron flywheel.

**(C9.13) DESTRUCTION:** The positron flywheel can only be destroyed by two successive breakdowns (C9.234). It cannot be destroyed by the DAC or a hit-and-run raid. It can be destroyed by the owner (to prevent capture) using the same procedure as a cloaking device (G13.162).

**(C9.14) UNCONTROLLED:** An uncontrolled ship (G2.27) cannot benefit from a positron flywheel.

**(C9.2) RESTRICTIONS AND CONDITIONS**

**(C9.21) DIRECTION:** The momentum stored in the flywheel is specific to the direction that the ship was traveling at the time it was stored. Thus, forward momentum cannot be used to move in reverse. If the ship reverses direction within the normal rules, all momentum stored in the previous direction is lost immediately. See (C3.553).

**(C9.22) PRE-SCENARIO SPEEDS:** A positron flywheel cannot use any speed which the ship used before the scenario started. It can only use a speed at which the ship moved during the scenario.

**(C9.23) RESET:** Some effects and maneuvers will cancel the effects of a positron flywheel.

**(C9.231) Emergency deceleration stops a positron flywheel.** If a ship has used emergency deceleration, it cannot use any speed prior to that point as the basis for flywheel computations; see (C8.24).

**(C9.232) Docking (C13.47) stops a positron flywheel.** This applies to all forms of docking to bases or ships, but does not include recovery of PFs, shuttles, or satellite ships.

**(C9.233) Becoming part of a pinwheel stops a flywheel;** see (C14.15).

**(C9.234) If the ship breaks down (C6.5), the positron flywheel is stopped and speeds prior to that point cannot be used.** If the ship breaks down a second time, the flywheel is destroyed. It cannot be repaired during a scenario; repairs at a base will require 100 repair points.

**(C9.235) Braking (C3.553) stops a positron flywheel.**

**(C9.24) DISENGAGEMENT:** To disengage by acceleration (C7.1), the ship must actually move at its highest possible speed for a complete turn (C7.11). The positron flywheel can help the ship reach this speed faster, but does not excuse the ship from the required period at that speed.

### (C9.3) COST

To add positron flywheel to a ship requires a BPV surcharge of 50% (round fractions up) of the ship's basic BPV not including Commander's Options purchased under (S3.2).

### SYNOPSIS OF MOVEMENT RULES IN SFB ADVANCED MISSIONS

To aid in later integration of Basic Set with a whole range of advanced and expansion products, the Basic Set rules are filled with numerous cross-references to the rules from those other products. Of course, if you do not have a given product, then any rules from that product cannot be used; they do not impose any penalties or provide any benefits to the player. To aid in understanding the Basic Set rules, and to prevent confusion over these references to rules in other products, the following synopsis of these rules is provided.

**(C10.0) ERRATIC MANEUVERING (Optional Rule):** This system allows a ship to "jink" while moving along its basic course, making the ship harder to hit (at the cost of making it harder for the ship's weapons to hit their targets). This is expressed as an electronic warfare penalty.

**(C11.0) NIMBLE SHIPS (Advanced Rule):** Certain small ships are rated as "nimble." These units have certain advantages in maneuver. Two of the ships in Basic Set (the Orion CR and the Tholian PC/PC+) are nimble.

Nimble benefits include:

Subtract 1 from the die roll for asteroid damage (P3.221) and ring damage (P2.223).

Make two HETs with die roll shifts rather than one (C6.521).

Add one to the Quick Reverse Die roll (C3.6).

Harder to hit (E1.7).

Advantageous movement order (C1.313).

Subtract 1 from die roll to avoid small moon (P2.231).

A ship will lose its nimble benefits if it is crippled or suffers a breakdown.

**(C12.0) CHANGING SPEED IN MID-TURN (Commander's Rule):** Under the rules in Basic Set, a ship moves at the same speed for the entire turn (with some exceptions such as web and emergency deceleration). Under rule (C12.0) in Advanced Missions, ships can plot speed changes during the turn, allowing them to move faster during some portions of the turn at the cost of moving more slowly during other portions. This rule is very complicated, but one of the most tactically rewarding.

**(C13.0) DOCKING (Advanced Rule):** This rule provides the necessary procedures for docking a ship to a base or to dock two ships to each other.

**(C14.0) THOLIAN PINWHEEL (Advanced Rule):** This rule allows three Tholian ships to dock together to form a small, virtually immobile, base. This is, in effect, a "circle the wagons" tactic when a patrol squadron is confronted by a larger enemy force and must await reinforcements.

END OF SECTION (C0.0) BASIC SET



**(D0.0) COMBAT****(D1.0) GENERAL RULES**

Combat takes place during the impulse procedure of each turn. Combat consists of firing weapons at the units of the opposing player (or players) with the intention of damaging or destroying those units.

**(D1.1) PURPOSE OF COMBAT**

The actions of combat are a means to an end, not an end in themselves. Combat is a means to gain or maintain control of territory or to destroy or reduce enemy forces as a means to that end. The operation of combat involves causing damage to enemy units to such an extent as to destroy them or compel them to go elsewhere.

**(D1.2) OPERATION OF COMBAT**

Within the game, players will use weapons to cause damage to enemy ships (or other units). The impact of each weapon results in a number of "damage points" as determined by the rules for that weapon. These damage points are then allocated by the Damage Allocation Chart or DAC (D4.21) to cause damage to specific equipment on board the ship (or by other procedures to cause damage to other types of units), thereby reducing its capabilities.

**(D1.3) WEAPONS TYPES**

Weapons are divided into two types. These are "direct-fire" and "seeking." Direct-fire weapons score damage immediately when they are fired. Seeking weapons move toward their targets and score damage after impact; this movement may take several impulses or even several turns. Many other systems, such as mines (M0.0) and expanding sphere generators (G23.0), cause damage and therefore have some of the effects of weapons, even though they are not actually weapons.

The term "weapons" is used in various contexts to include different items. Refer to Annex 7D for specific information.

**(D1.31) DIRECT-FIRE WEAPONS** include, for example, phasers, disruptor bolts, and photon torpedoes. Direct-fire weapons are covered in section (E0.0). These are weapons, which are aimed and fired at targets; their effects are resolved immediately (in the Direct-Fire Segment).

**(D1.32) SEEKING WEAPONS** include drones, plasma torpedoes, and in some cases shuttlecraft. Seeking weapons (F0.0) are "launched" during a specific part of the turn and represented by a counter that moves on the map and follows a target. Their damage is resolved during the Movement Segment (when they hit their targets).

**(D1.4) RANGE**

To determine the range to the target, count the number of hexes from the hex occupied by the firing unit to the hex occupied by the target unit along the shortest possible route without skipping hexes. Count the hex occupied by the target, but not the hex occupied by the firing unit. If both are in the same hex, the range is zero. This is the "true range." The "effective range" (which may be different from the true range due to sensors, scanners, cloaking devices, and other effects) is the range used on the various weapons tables. The line of fire is traced from the center of the hex the firing unit is in to the center of a target unit's hex. If the line of fire passes through blocking terrain, it is blocked. Even though you could count a line of fire between the two units that does not pass through any blocking terrain hexes, direct-fire would be still blocked.

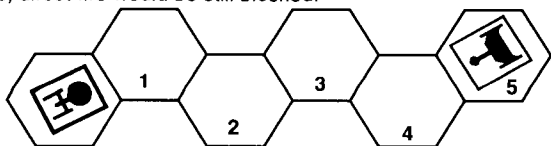

Effective range = True range [which will be doubled if there is no lock-on, perhaps because of sensor (D6.1) damage or a cloaked (G13.301) target]  
 + Scanner factor  
 + other adjustments required by various rules, such as a nebula (P6.71) which adds three for some effects, or a cloak (G13.302) which adds five.

All range rules use "effective range" unless specified otherwise.

**(D1.5) FRIENDLY FIRE**

There are some cases under which a unit may be compelled to fire on a friendly unit (i.e., a ship on the same side). This is known as "friendly fire," a term that indicates the origin (not the nature) of the firepower involved. To prevent player abuse, there are several restrictions on this procedure. Units may not fire upon or guide weapons targeted on a friendly unit except in the cases listed below. (Note that the target unit may be manned or unmanned.)

Players are never required (by the rules) to use friendly fire. The tactical situation may make it advisable.

**(D1.51) SELF-DESTRUCTION:** A friendly unit may be fired upon if it is eligible for self-destruction (D5.51). Friendly PFs can be fired at only if the entire crew has been evacuated.

**(D1.52) CAPTURE:** A friendly unit may be fired upon to prevent its capture. This is defined as one or more of the following conditions:

**(D1.521)** The unit is in danger of being captured by boarding. To qualify for this, it must satisfy all of the following requirements:

**A.** Be within transporter range of at least one enemy ship with available boarding parties and operable transporters.

**B.** Have at least one destroyed shield facing enemy ships within transporter range.

**C.** Have enemy boarding parties on board equal to 75% of its own boarding parties (round fractions up) including all currently available conversions to militia. (If the enemy boarding parties are equal to 150% of the friendly ones, conditions A and B are not required.)

**(D1.522)** Other friendly units are disengaging and the unit in question is unable to disengage. In this case, all friendly units must, after firing at the unit, proceed to disengage in an expeditious manner. They may fire at the endangered unit until it is destroyed. They may fire only at that unit [plus any target qualified for Aegis (D13.2) fire] until they have disengaged. The disengaging player must announce when he is invoking this rule; this can be done on any given impulse.

**(D1.523)** The unit is held in an enemy tractor beam and is unable to break free after at least one complete turn of attempting to do so, including using all reserve power and the maximum available power (not counting weapons, shields, fire control, life support, and one point of movement) during an Energy Allocation Phase auction.

**(D1.524)** If the ship is captured by enemy boarding parties, it becomes an "enemy" ship and can be fired on; the friendly fire rules do not apply.

**(D1.53) SEEKING WEAPONS:** Friendly seeking weapons can be fired upon without restriction. This rule applies if the weapon has a chance of scoring one or more damage points, regardless of whether or not actual damage results from the die roll.

A friendly scatter-pack shuttle which is fired upon (by friendly fire) but not destroyed loses its tracking and goes inert; see (FD7.47). (This does not apply to other seeking weapons.)

**(D1.54) WILD WEASEL:** An active friendly wild weasel may not be fired upon at any time because of the battle computer interlocks. A voided WW may be fired on to prevent its capture; see (J3.22).

**(D1.55) SWAC, PFS:** A friendly SWAC shuttle or wild PF scout is treated as a ship for purposes of friendly fire.

**(D1.56) SELF-FIRING:** Ships cannot fire at themselves, launch seeking weapons at themselves, or guide seeking weapons toward themselves. Ships cannot allow their own weapons to explode in the launch tubes. (You might want to do it, but your weapon crews do not appreciate your motives.)

ECM drones using station keeping (FD9.11) are an obvious exception to this rule. While an ECM drone could also carry an

explosive payload, an ECM drone-using station keeping would never explode because it never hits its target.

**(D1.57) ANDROMEDAN MAULERS:** Andromedan ships may fire at their maulers for purposes of recharging energy, but only if the fire cannot (by any mathematical chance) exceed the capacity of or penetrate the panels. This rule does NOT allow a mauler to fire at other Andromedans (including another Andromedan mauler), nor does it allow a non-mauler Andromedan to fire at other Andromedans.

**(D2.0) FIRING ARCS**

All ships with weapons have those weapons designated as to which direction they can fire. This is done in terms of firing arcs.

**(D2.1) FIRING ARC DESIGNATIONS**

Note the diagram to the right. This diagram is used to designate firing angles for all ships in the game. It is repeated on each SSD. The area around each ship is divided into six "firing arcs," each of which is designated by code letters:

LF - left forward, RF - right forward, L - left, R - right, LR - left rear, RR - right rear.

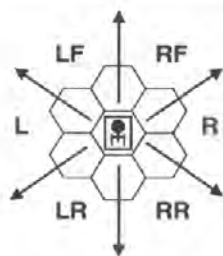

**(D2.11) DESIGNATION:** Each weapon on the SSD (except for drones and ADDs) is marked with one or more of these designations. For example, the left phasers on the Federation heavy cruiser are marked: L+LF. This indicates that they can fire in the left and left forward firing arcs. Note that when several weapons are shown as a group of adjoining boxes (such as the two phasers on the Fed CA just mentioned), all of them can fire in all of the arcs shown. In some cases (such as the wings of the Gorn BC), two separate sets of phasers are given a single firing arc designation to save space.

**(D2.12) BOUNDARIES:** Each firing arc is a 60° section of the map bounded by two straight rows of hexes.

For example, a ship in hex 0925 which is facing hex 1025 (direction C) would have a right forward (RF) firing arc bounded by the row of hexes from 0925 to 1628 (directly forward) and the row from 0925 to 0932. All hexes on these rows (which extend to infinity) are within the RF firing arc and can be fired at by any weapon capable of firing in the RF arc (examples: 1132, 1229, 1430, 1831, 0927, and 1528). Hexes outside of this arc (examples: 0716, 2610, 0924) cannot be fired at by a weapon with only the RF designation.

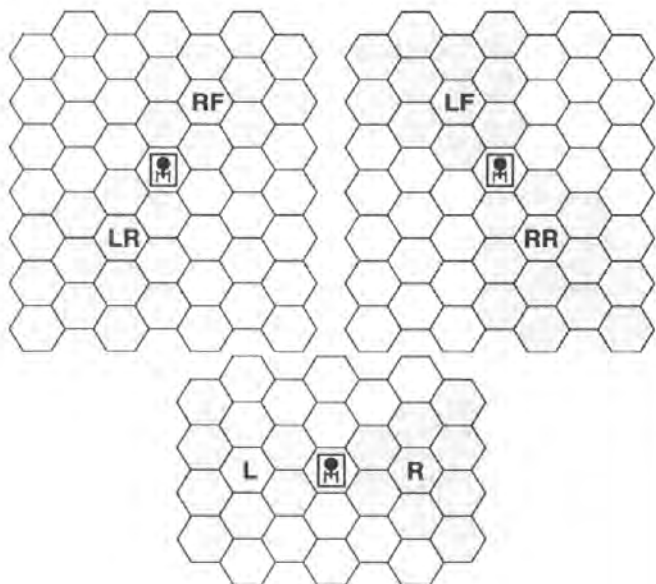

**(D2.13) 360° FIRING ARCS:** Some weapons are designated as 360°. These weapons can fire in ANY firing arc. Note that each firing arc overlaps the adjacent arcs on each side by a single row of hexes. For example, all six phasers in the saucer of the Federation Heavy Cruiser can fire down the hex row directly ahead of the ship.

**(D2.14) SPECIAL CASES:** Some ships have special firing arc restrictions or additions noted directly on their SSD.

Rule (D2.3) below has some other special firing arcs.

**(D2.2) COMBINED FIRING ARCS**

For simplicity, some firing arc designations are combined into a shorthand version. Combined designations used in the game are:

- FA = FRONT ARC = RF + LF
- FX = FRONT ARC EXPANDED = L + LF + RF + R
- RA = REAR ARC = LR + RR
- RX = REAR ARC EXPANDED = L + LR + RR + R
- RS = RIGHT SIDE = RF + R + RR
- LS = LEFT SIDE = LF + L + LR
- FH = FRONT HEMISPHERE = See (D2.31)
- RH = REAR HEMISPHERE = See (D2.31)
- LP = LEFT PLASMA = See (D2.34)
- RP = RIGHT PLASMA = See (D2.34)
- FP = FRONT PLASMA = See (D2.34)
- AP = AFT PLASMA = See (D2.36)
- LPR = LEFT PLASMA REAR = See (D2.36)
- RPR = RIGHT PLASMA REAR = See (D2.36)

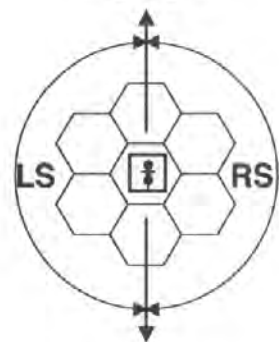
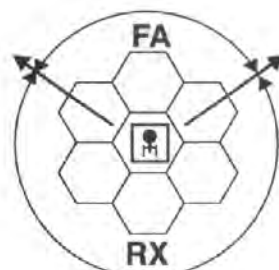
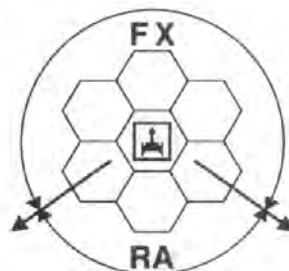

**(D2.3) SPECIAL MODIFIED FIRING ARCS**

The limitations of the hex grid and its 60° arcs make it impossible to accurately reflect the firing arcs of certain ships. Specially designated arcs must be used.

**(D2.31) HEMISPHERIC FIRING ARCS:** The FH (front half or front hemisphere) firing arc is that shown in the diagram below.

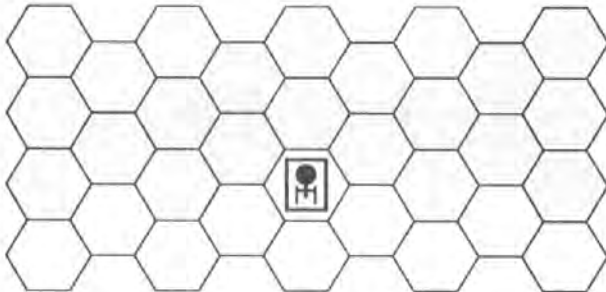

The RH (rear half or rear hemisphere) firing arc is shown below. It is used on the Federation Heavy Cruiser (with rear-phaser refit) and some other ships.

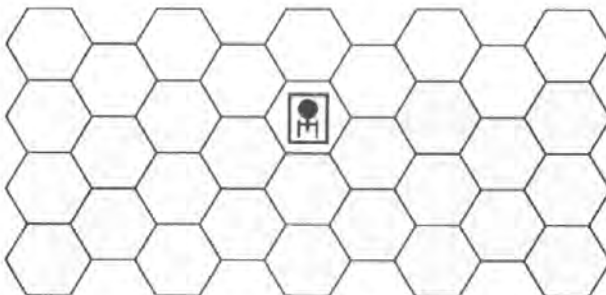

**(D2.32) KLINGON WING PHASERS:** The wing phasers on certain Klingon ships have a modified firing arc as shown in the illustration below. This illustration is for the right wing phasers on the D7 battlecruiser. This firing arc is used on the D7-, C7-, and D5-class ships (and their variants, and others so noted in their rules).

The hexes marked "+" represent hexes added to the firing arc of this position; they extend in a regular pattern to the full range of the weapon. This phaser position is able to fire cross-decks into a part of the left-forward arc, the two gaps representing the blind spots created by the command boom and left engine. The adjustment is included in the BPV. The hexes marked "-" are deleted in this revised firing arc. The right wing phasers CANNOT fire into the adjacent hex in direction 6 because the arc is too narrow to establish a firing solution. The D5G and D5H cannot use the "cross deck" arcs if they are carrying a pod.

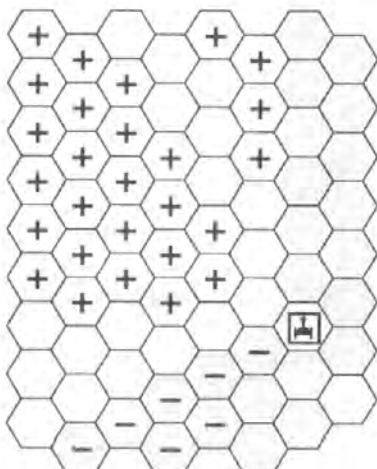

NOTE: Right Wing Phasers shown.

**(D2.33) KLINGON FORWARD PHASERS:** The forward phasers on certain Klingon ships use the firing arcs shown. The shaded boxes are part of their normal firing arc; the hexes marked "+" are used when the revised, "true" firing arcs are used; + hexes extend in a regular pattern to the maximum range of the weapon.

The forward phasers of the C7, DX, D7, D6, D5 (note that a pod will block the rear-firing arc on a D5G or D5H), F6, FX, F5L, F5, E5, E4, E3, G2, Cadet Ship, and Tug (pods will block the rear firing corridor) and all variants thereof, have the firing arcs shown. Other ships use these arcs if designated to do so. Most Klingon SSDs include notes referring to these special arcs.

The B10, C9, C8, and Tug (with pods) have the side extensions to the main FX arc, but cannot fire to the rear so they do not have the shaded or + hexes directly behind the ship.

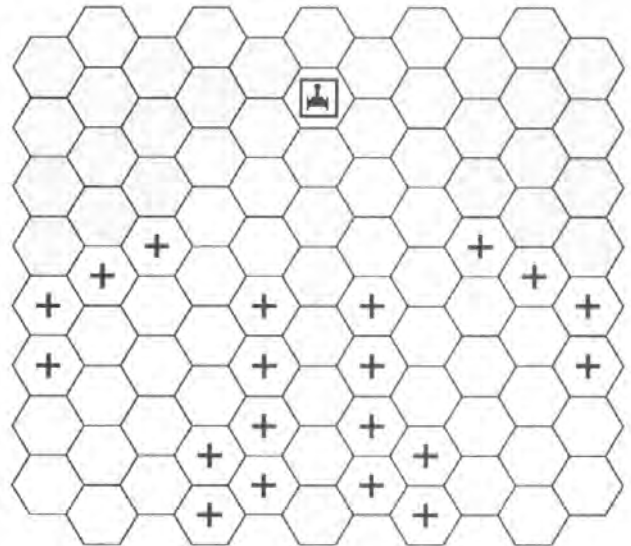

In the case of ships which have their forward phasers divided into two separate banks (FA+L, FA+R, such as F5) the L+FA phasers use the additional hexes on the left side (only), while the FA+R phasers use the additional hexes on the right side (only).

The wing phasers on the C8, C9, and B10 can fire to the rear into the hex row extending directly behind the ship, and into the additional (+) hexes on one side of that row (right wing to right side, left wing to left).

The illustration below shows the rear firing area for the right wing phasers on the B10 or C8/9 and for the right side boom phasers on the F5 (also E5, E4 series).



**(D2.34) PLASMA TORPEDO SWIVEL MOUNTS:** Certain ships are equipped with swivel mounts for their plasma torpedoes. These ships are able to track targets in a 180° firing arc and to fire their weapons in any of three specified directions. The illustrations below show these arcs, which are designated LP, FP, and RP (for left, forward, and right plasma arcs).

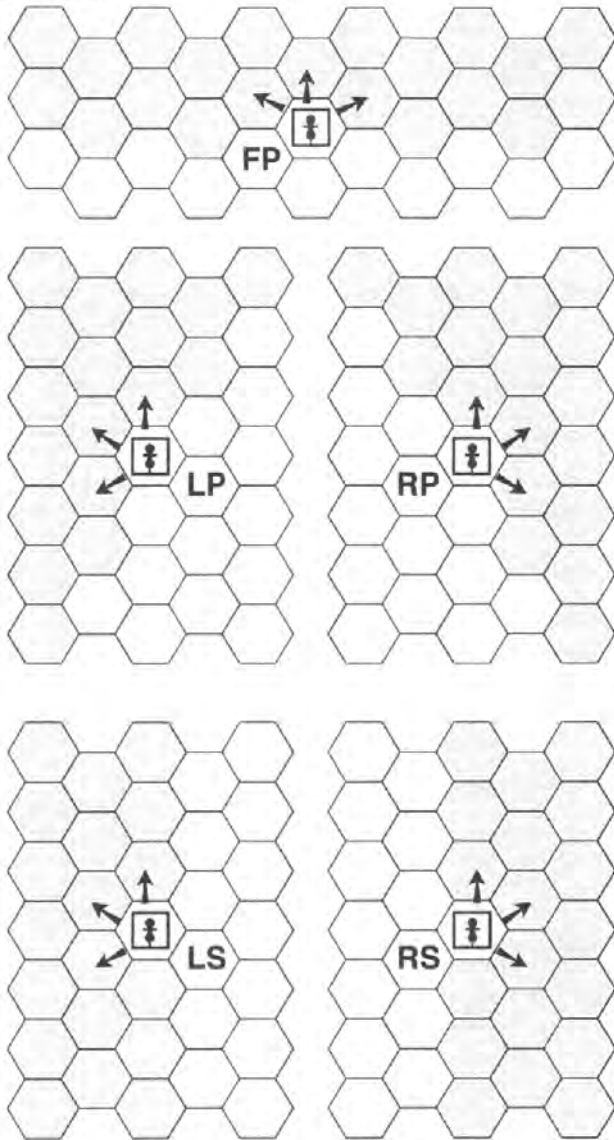

Arrows denote launch direction.  
Shading denotes tracking arc.

Some ships have small type-F plasma torpedoes in LS or RS mounts, rather than LP or RP. These can track targets in the LS or RS arcs and can be fired in directions 1, 5 or 6 (LS) and 1, 2 or 3 (RS). This is primarily an anti-fighter defense weapon, set in this arc to avoid a blind spot at the tail.

Plasma racks for type-D torpedoes using LS/RS arcs are defined in (FP10.12).

**(D2.35) ISC REAR-FIRING PLASMA TORPEDO ARCS:** Most of the ships used by the Interstellar Concordium (R13.0) are equipped with rear-firing type-F plasma torpedoes.

The ISC is presented in Module C2. If you do not have module C2, this data can be ignored.

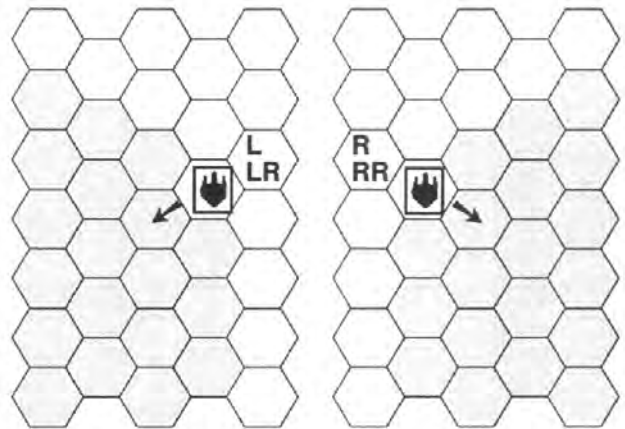

**(D2.36) GORN BATTLE POD REVERSE SWIVEL PLASMA TORPEDO FIRING ARCS:** These arcs are used by the Gorn Heavy Battle Pod and Light Battle Pod carried by their tug and light tactical transport. The position of the pod on the ship requires these unusual and difficult to use arcs.

These pods are in Advanced Missions and Module R4; this data can be ignored by Basic Set users.

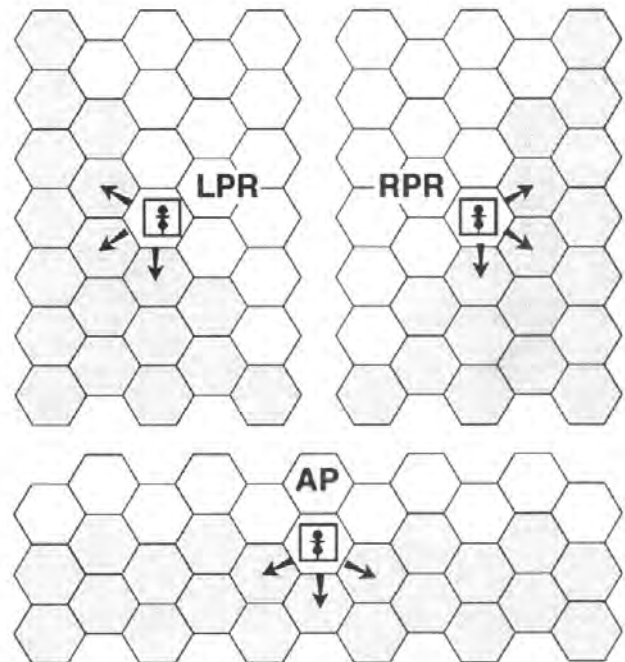

Arrows denote launch direction.  
Shading denotes tracking arc.

**(D3.0) SHIELDS**

Shields are the primary defense of starships in this game. Shields will absorb tremendous amounts of punishment, can be operated at various power levels, can be repaired during the scenario, and can be reinforced.

Shuttles and seeking weapons do not use these shield rules (except in special cases noted in certain advanced rules).

**(D3.1) DESIGNATIONS OF SHIELDS**

**(D3.11) NUMBER:** Each ship is surrounded by six shields. These are numbered 1 through 6, and each shield faces one of the six surrounding hexes. (For example, if a given starship was in hex 0202 and facing hex 0201, the #1 shield would be facing hex 0201, #2 would be facing 0302, and #5 would be facing 0103.)

Exceptions: Interceptors (K3.4) have two 180° shields. Some X-shuttles (X0.0) have one 360° shield. Certain other units (noted in their respective rules) have other shield arrangements.

**(D3.12) POSITION:** The shields are fixed in position relative to the ship and cannot be rotated or moved. If a given shield is down, it is down until repaired by damage control (D9.0) or other repair systems. No other shield can be shifted into its position or expanded to cover a larger arc. The #1 shield will always be to the front of the starship.

**(D3.13) STATUS:** Shields can be "down" [reduced to zero strength by damage (D3.21)] or "dropped" [voluntarily inactivated to facilitate the use of transporters (D3.5)].

**(D3.2) SHIELD OPERATION**

The shields are represented on SSDs by rectangular groups of boxes surrounding the ship. These are marked "shield #1," etc.

**(D3.21) DAMAGE:** Each hit on a shield checks off one box. When all boxes on a given shield are checked off, the shield is "down." Damage points scored on a shield that is "down" penetrate to the interior and destroy systems within the ship. These are called "internal hits" or "internal damage points."

**EXCEPTION:** In the case of ships with armor (D4.12), damage which penetrates the shields must also penetrate the armor before it is considered "internal" damage. Also, General Reinforcement (D3.341) can stop damage that would otherwise hit a down shield.

**(D3.22) REINFORCEMENT AND REPAIR:** Shields can be reinforced (D3.34) and repaired by Damage Control (D9.2). Shields can also be repaired by Continuous Damage Control (D9.7), but this would probably be a waste of resources. Shields can also be repaired by Repair systems (G17.32), but they cannot be repaired by Emergency Damage Repair (D14.23).

**(D3.23) DROPPING SHIELDS:** Shields can be dropped by (D3.5), but if this is done, the fact must be announced immediately at the time any shield is dropped.

**(D3.24) DETECTING STRENGTH OF SHIELDS:** The strength of your shields is generally known to your opponent.

**(D3.241) Rule (D4.14)** provides that the ship portion of the SSD can be inspected at any time, so the enemy will usually know how many damage points have been scored and how many boxes remain on each shield.

**(D3.242)** The operating level (off, minimum, standard) of shields will be known; see (D3.31). Any shields that have been dropped will be known; see (D3.54).

**(D3.243)** If using the optional Tactical Intelligence rule (D17.0), this information will not be known except as provided therein.

**(D3.3) ENERGY COST OF SHIELDS**

Shields can be operated at "minimum" level or at "full strength." They can also be repaired. All of this requires varying amounts of energy depending on the ship.

**NOTE:** As with most rules involving energy, the optional Energy Balance due to Damage (D22.0) rules could result in allocated power being cancelled in mid-turn.

**(D3.31) STRENGTH OF SHIELDS:** Minimum shields are five boxes in each direction. Full strength shields mean that all of the boxes printed on the SSD are active and available to absorb damage. The difference between minimum and standard shields can be detected; the ship must announce its shield level when entering the scenario and whenever it changes. See also Tactical Intelligence (D17.4) Level B.

Reinforcement (D3.34) creates the effect of additional boxes, but these boxes cannot be detected; exception (D17.71).

**(D3.32) COST OF OPERATION:** The cost to operate a ship's shields is based on its size. The size class of each ship is shown on the MASTER SHIP CHART. The cost to operate shields (per turn) is shown below:

SIZE CLASS	MINIMUM	FULL	TOTAL
1 (Starbases)	= 2	+ 5	= 7
2 (Dreadnoughts)	= 1	+ 3	= 4
3 (Cruisers)	= 1	+ 1	= 2
4 (Destroyers)	= 0.5	+ 0.5	= 1
5 (PFs)	= 0.5	+ 0.5	= 1
6 (Shuttles)		— Not Applicable —	
7 (Seeking weapons)		— Not Applicable —	

Note that all costs are given as Minimum+Full, and full shields cannot be operated without also operating minimum shields. For a ship to have all of the boxes on its SSD active, it pays the number in the "Total" column.

Separated booms and saucers (G12.332) do not pay for shields.

**(D3.321)** When not using fractional accounting (B3.2), the cost of operation for size class 4 or 5 is 1 for minimum and +0 for full. The ship types in parenthesis are generalizations for purposes of illustration; refer to the MASTER SHIP CHART for the size class of each ship. (For example, the Gorn Heavy Destroyer is in fact a size-3 cruiser.)

**(D3.322)** Energy for shields can be provided during Energy Allocation or can be reserve power (H7.34). If energy is allocated for shields during Energy Allocation, the shields are presumed to be up from the start of the turn unless declared otherwise by the owning player. [If the shields had been dropped during the previous turn, the 1/4-turn delay (D3.52) could delay their activation.] If energy was provided during allocation but the shields were not activated, the power remains available and the shields may be activated during the Operate Shields Step of any later impulse. Shields activated at minimum level can be raised to standard level with reserve power or with allocated power during the Operate Shields Step of any impulse [but not in response to damage (H7.345)]. Any change in shield level is done during the Operate Shields step of the Impulse Activity Segment of any impulse. Dropping shields is covered in (D3.5).

**(D3.33) OPERATION OF MINIMUM SHIELDS:** If a given shield has 20 boxes, but is operated at "minimum" level, only five of those boxes are operable and available to absorb damage. If six (or more) hits were scored on the shield in this condition, the first five would destroy the minimum level shield and the remainder would penetrate to become internal hits, even though 15 undestroyed (but unpowered) shield boxes remained.

**(D3.331)** The five boxes of the minimum shield are the first to be destroyed and the last to be repaired, even if the shield is at full power. Thus if the shield above was at full power and took two damage points (reducing it to 18), and later was operated at minimum power, it would only have three working boxes. It could be reinforced. There is an exception for detached booms and saucers in (G12.333).

**(D3.332)** Enemy sensors (assuming they have a lock-on) are capable of telling if a ship's shields are at full or minimum levels at a range of 50 hexes; see (D17.4) Level B. See (D17.71) for an optional exception. Also note Q-ships (R1.7) for another exception.

**(D3.333)** Some smaller ships have only 5 (or fewer) shield boxes. These ships can pay the minimum shield cost and need not pay the full cost.

**(D3.334)** Any change in the shields, from full to minimum, or from minimum to full, can only be done once in any eight impulse period, i.e., if dropped to minimum on Impulse #8 they cannot be raised back to full until Impulse #16. A change during Energy Allocation counts Impulse #1 as the first impulse to determine the interval before the next change. Shields can be dropped completely on any impulse irrespective of their setting or when their setting was changed (D3.5) and might be dropped while at minimum setting and raised at full strength.

**NOTE:** There are relatively few uses for minimum shields, and beginning players can safely ignore this section and simply pay the total cost in (D3.32) for full-strength shields.

**(D3.34) REINFORCEMENT:** The purpose of reinforcement is to use some of the ship's energy to absorb hits and prevent them from damaging the ship's shields (i.e., to avoid marking out any boxes on the SSD). General reinforcement can be used so long as the shields are operated on at least minimum level, even if no shield boxes remain. Note that ships which never had shields (for example, Andromedans) cannot use either type of shield reinforcement.

See (D3.55) for rules on dropping reinforcement.

**(D3.341) GENERAL REINFORCEMENT:** Energy supplied for general reinforcement is divided by two, and the result (round fractions down) is the number of general reinforcement points available during that turn. These points reinforce all shields and are eliminated by the first damage points from any direction (but NOT from each direction). For example, if ten units of energy had been provided during the current turn, this would provide five points of general reinforcement. The first five damage points scored on the ship during this turn (regardless of direction) destroy this general reinforcement.

**(D3.3411)** When resolving damage, any points of operating general reinforcement must be used before using any points of specific reinforcement, and all reinforcement must be used before any SSD boxes are destroyed. This is NOT at the option of either player.

**(D3.3412)** In the case of certain weapons, such as enveloping plasma torpedoes (FP5.0) and hellbores (E10.0), general reinforcement is subtracted from the weapon's strength before damage is calculated. It is the number of general reinforcement points, not the number of energy points, that is subtracted.

**(D3.3413)** On any given impulse during any given damage step, if damage from more than one direction strikes a unit with General Shield Reinforcement (GSR), even against the same shield facing, the larger damage total is resolved against the GSR first before any of it is combined into volleys (D4.22). If equal damage is scored from two or more directions, roll a die to determine which is resolved first.

**(D3.342) SPECIFIC REINFORCEMENT:** Energy supplied for specific reinforcement adds a number of "extra" boxes (equal to the amount of energy applied) to that shield for the duration of the current turn.

**(D3.343) DOWN SHIELDS:** A shield that is down (or which has been dropped) cannot be reinforced, but general reinforcement would still block fire coming from that direction (for as long as it lasts).

**EXAMPLE:** A given ship has a front shield consisting of 20 boxes. The ship has allocated 10 points of energy to reinforce the front shield and 6 points to general reinforcement. At a given point in the turn, 2 damage points are scored on a different shield, eliminating 2 of the 3 points of general reinforcement. Later during the turn, 15 points of damage is scored on the front shield. The first point is stopped by general reinforcement, the next 10 by specific reinforcement, and the last 4 score "permanent" hits (i.e., they check off boxes which could be repaired later) on the shield, reducing it from 20 boxes to 16. Note that without the reinforcement, the shield would have been reduced to 5 boxes.

**(D3.344) INDEPENDENCE:** General and specific reinforcement are independent of each other. A ship is not required to operate one type in order to operate the other type.

**(D3.345) RESERVE POWER** can reinforce shields; see (H7.34).

**(D3.346) INACTIVE STATUS:** As with energy allocated to shields which remain inactive (D3.322), reinforcement energy can be provided by allocation and left inactive. It can then be activated under the Operate Shields Step.

**(D3.4) DETERMINING WHICH SHIELD WAS STRUCK BY ENEMY FIRE**

**(D3.40) GENERAL:** It is important to determine which shield has been struck by incoming fire.

**(D3.401) SEEKING WEAPONS:** In the case of seeking weapons, this is the shield facing the hex that the weapon approached from. If the weapon was launched in the target hex and struck the target before the target moved, determine what shield would have been hit by direct-fire weapons fired by the launching ship (D3.42); this is the shield hit by the seeking weapon. (NOTE: As per the Sequence of Play, the target will have the opportunity to fire at the weapon before it impacts.)

**(D3.402) DIRECT-FIRE WEAPONS:** For direct-fire weapons, the line of fire must be determined. To do this, simply draw an imaginary line from the center of the target ship's hex to the center of the firing ship's hex, and determine which shield is crossed.

**EXAMPLE:** A ship in hex 0202 is attacked by a ship in hex 0305. A line from hex 0305 to hex 0202 crosses the hex side separating hex 0202 from hex 0203; therefore, it is the rear shield (#4) which takes the damage.

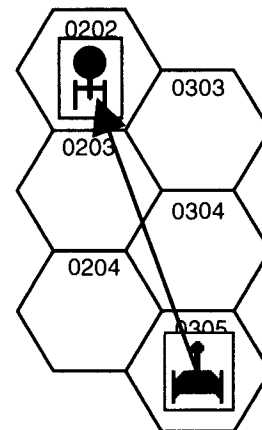

**(D3.41) SHIELD BOUNDARIES:** In the event that the line from the firing to target hex travels exactly along a hex side (for example, if the firing ship in the illustration above was in hex 0304), then the shield actually hit is resolved as follows:

- A. Examine the impulse chart,
- B. Determine which ship is scheduled to move next (including the Order of Precedence), and
- C. Move that ship (temporarily, for purposes of this determination only) one hex directly forward.
- D. Judge the shield facings (not firing arcs) from this position.

Note specifically that this "move one hex forward" principle is used regardless of what the owning player wanted, intended, or considered moving on the next impulse, that it is used even if it is physically impossible or tactically unwise to actually move forward (planet, minefield, map edge, etc), and that this does not in any way obligate the player to actually move forward on the next moving impulse. The intent here is to determine which way the line of sight between the ships is tending to rotate. The ship does not actually move, and the range is based on the actual hexes occupied. Movement that might be caused by terrain (e.g., black holes, nebulae, etc.) or other effects (e.g., tractor rotations, earned tactical maneuvers, potential quick reverses, etc.) is ignored.

If both ships are scheduled to move, refer to (D3.43).

**(D3.411)** In the case of ships at 0202 and 0304, if the ship at 0304 were to move next, it is presumed to move to hex 0303, and the shield would be determined from this position, and the #3 shield would take the damage. This procedure assumes that the moving unit will move directly forward. It does not create a requirement for the unit to actually move forward when the "real" movement step arrives. It is possible for such a move to completely change the situation.

**(D3.412)** Consider the case of the two ships at right. Both ships are moving in parallel and opposite directions. If either were moved forward one hex while the other stayed in place, their #6 shields would clearly be facing. But if both are scheduled to move simultaneously, their #5 shields would be facing. In such case, you would consider the shield that would be crossed first, that being #6, because this is the shield that the line of fire is "tending toward."

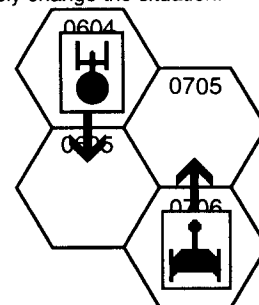

**(D3.42) SHIPS IN THE SAME HEX:** If two ships are in the same hex, relative firing directions and shield facings are determined as follows:

1. Determine which ship entered the hex first; see (C1.313) if both entered on the same impulse. Return the other ship to the hex which it previously occupied and judge the firing arcs and shield facings from this position.
2. If (C1.313) produces a draw (both ships entered simultaneously), use (D3.43).

A more detailed system (which might allow a ship to enter a hex, fire its FA weapons on one impulse and its RA weapons on the next) is under development for publication in a future product.

**(D3.43) RESOLUTION OF AMBIGUOUS SITUATIONS:** There are certain situations that can arise in complex maneuvers where the

determination of which shield has been hit becomes difficult. Players are advised to resolve the situation with common sense, defined by these principles:

A. If both ships are to move simultaneously in their next movement, and this movement still leaves the situation unresolved, judge the shield hit from the situation as if ONLY the target ship had moved.

B. If the next movement would result in a situation unresolvable by "A," or in both of the possible shields being turned away from the firing ship, resolve the situation by judging which of the potential target shields would be crossed first.

C. If no other means of resolution is possible, use one of these methods to apply the damage. (Option #3 is used unless the players have agreed in advance to use a different option.)

1. Divide the effect of the weapon in half and apply half to each of the two shields. If there is an odd number of hit points, allow the firing player to apply the final point to either of the two shields at his option.
2. Toss a coin (or roll a die) to determine which shield is hit.
3. Allow the owning player (of the target ship) to select which shield was hit. Even if nothing changes, this decision can be changed each impulse. (This is used if two ships are linked by a tractor beam at range 2; and during Impulse #32.)

The method used may be selected by the players by mutual consent, but should be used consistently throughout an entire scenario.

**(D3.44) TRANSPORTERS** use a slightly different means of determining which shield is facing the line of sight. See (G8.21) for a detailed explanation with examples. Those examples do not necessarily apply in the case of weapons fire.

### (D3.5) DROPPING SHIELDS

A unit may drop one or more of its shields. This might be done to allow transporters to be used, as a show of good faith, to conserve power, or for other reasons.

**(D3.51) PROCEDURE:** A ship can drop one or more of its shields during the Operate Shields Step of the Marine Activity Stage of the Impulse Activity Segment of any impulse. Once dropped, the shield must remain dropped for at least 1/4 turn (i.e., 8 impulses). When dropping a shield to facilitate the use of transporters, see (G8.21).

**(D3.52) DELAY:** A ship that did not allocate power to its shields during Energy Allocation cannot raise them (with reserve power) until 1/4 of a turn has elapsed since the start of the turn (or since the shields were dropped during the prior turn). Shields are raised immediately in the Sequence Of Play when announced, the delay in raising them is from the point where they were dropped, and is not a delay between announcement and raising them. A ship cannot enter a scenario with a shield already dropped unless this is specifically allowed or required by the scenario rules. The ship could, of course, drop a shield on the first impulse or allocate no power for shields.

**(D3.53) NUMBER:** A ship can drop and raise more than one shield at the same time by this procedure. Shields can be raised and dropped independently; they need not all be dropped or raised at the same time so long as each one is operated within the limits required.

**(D3.54) DETECTION:** Any unit with a lock-on to a ship can detect the level (inactive, minimum, normal) of all of the shields of that ship and will, therefore, instantly detect any dropped shields. When a shield is dropped, this fact must be announced immediately.

**(D3.541)** The level of Andromedan PA panels (off, standard, reinforced) is also detected by this procedure; see (D10.26) and (D10.56).

**(D3.542)** When using the optional Tactical Intelligence rules in (D17.0), this detection is limited to a certain range, but as that range is on the order of 20-100 hexes any range effects can be ignored when not using those rules.

**(D3.543)** The shield status of cloaked ships cannot be detected (G13.12) without a lock-on; cloaked ships cannot determine the shield status of other ships (G13.517).

**(D3.55) REINFORCEMENT:** A ship can drop its general or specific reinforcement.

**(D3.551)** If a shield is dropped, any specific reinforcement to it is also dropped. If raised again on the same turn, the reinforcement is restored unless previously cancelled.

**(D3.552)** A ship cannot drop its General Reinforcement to only some shields, but must drop all General Reinforcement; see (G8.23). This can be raised again on the same turn as with specific reinforcement.

**(D3.553)** Dropping and raising of reinforcement is subject to the delays of (D3.51) and (D3.54).

**(D3.56) REDUCTION:** The strength of a shield can be voluntarily reduced for deception purposes; see (D17.711).

### (D3.6) LEAKY SHIELDS RULE (Optional)

This rule assumes some damage from each volley will penetrate the shields. This tends to shorten games by causing ships to be destroyed or rendered combat ineffective more quickly. It can also create some interesting situations as key equipment is knocked out.

This rule should be used only to experiment with the effect (or to try something different); it is not intended as a standard rule. It is used in some tournaments to shorten the playing time.

This rule can be used for Andromedans; see (D10.57).

**(D3.61) PROCEDURE:** Instead of all hits on a given shield being scored against that shield until it is down, allow every fourth (optionally, sixth or tenth) hit to penetrate as an internal damage point. All damage which penetrates a given shield in a given damage step of a given impulse is treated as one volley.

**(D3.62) DOWN SHIELDS:** If a single volley destroys the shield, the "leaked" damage points (before the shield is destroyed) are combined with the "excess" points (those remaining after the shield is destroyed) into a single volley.

**(D3.63) EXAMPLE:** 45 points of damage are scored on a 30-point shield. The first 36 points destroy 27 points of the shield and 9 points "leak" as internal damage. The next 3 points destroy the rest of the shield; the 6 "excess" points are added to the 9 "leaked" points for a single 15-point volley of internal damage.

## (D4.0) DAMAGE ALLOCATION

When damage is scored on a ship, the effect of that damage must be determined. This is done by allocating this damage to certain areas and systems of the ship.

Basically, each point of damage marks off one box on the SSD (a shield box, armor box, or internal system box); destroyed boxes do not function (unless repaired). See (D4.23) for a list of units which use non-standard forms of Damage Allocation.

### (D4.1) DETERMINING INTERNAL HITS

Damage points scored must be allotted to the systems on the target ship's SSD by the following procedure:

**(D4.11) DETERMINE SHIELD HIT:** All volleys are presumed to first strike shields. In recording damage, the first step is to determine which shield was hit (D3.4). Hits scored are recorded against that shield (or bank of PA panels in the case of an Andromedan ship) by the procedures set forth in the shield rules.

**(D4.12) ARMOR:** Some of the ships included in the game have armor installed in their hulls (specifically: starbases, base stations, battle stations, the Federation CL, the Romulan Warbird/War Eagle, and some others noted in their ship descriptions and/or on their SSDs).

The term "armor" accounts for a variety of defensive systems, not simply thick metal plates. A series of internal energy dampers was used on early ships (before shields) and is treated as armor on those ships. Damage points which penetrate the shields strike the armor (each damage point destroying one armor box); after the armor is destroyed, the damage proceeds normally.

The special starbase damage procedures (R1.1D) account for armor in a slightly different manner.

**(D4.13) INTERNAL HITS:** Any hits which penetrate the shields and armor are distributed among the interior systems of the ship (causing considerable damage) by the Damage Allocation Procedure (D4.2) which uses the DAMAGE ALLOCATION CHART (D4.21).

See (D4.23) for some exceptions.

**(D4.14) DAMAGE RECORDS:** The damage records on the ship portion of the SSD are not secret. Any player may examine the ship portion of the SSD of any ship (even a cloaked ship) at any time. This is unlike the Energy Allocation Forms, which ARE secret. The ammunition (drone, PPT, mine, crew, etc.) tracks on the SSD sheet are also secret and need not be revealed to the enemy.

Note that when using (D17.0) Tactical Intelligence this rule is restricted by the data in that rule.

**(D4.15) DEFINITION:** The terms "damage point" and "hit point" are interchangeable, but "hit" is not strictly interchangeable with either. A weapon can score a hit, which scores several damage points.

#### **(D4.2) DAMAGE ALLOCATION PROCEDURE**

This procedure is used to distribute damage points which have penetrated to the interior of the ship. These points are distributed by the DAMAGE ALLOCATION CHART. For NVC see (D6.4).

**(D4.21) DAMAGE ALLOCATION CHART** (see separate sheet). PFs and interceptors use a special DAC found in (K5.0).

**(D4.22) PROCEDURE:** First determine the number of damage points which have penetrated the shield (including reinforcement) and armor (if any). Each internal damage point must be distributed individually. All damage points scored against a given shield in a given damage step must be resolved together and are collectively known as a "volley." Note that fire from several directions which all strikes the same shield is still resolved as a single volley, see (D4.34). Fire from several directions that strikes different shields is resolved as separate volleys, i.e., all fire that strikes the #1 shield of a given ship on a given impulse is one volley. Fire on a given impulse that strikes the #1 shield and #2 shield would be resolved as two separate volleys under (D4.3). Some weapons have special damage rules that form exceptions to this rule, examples (FP5.32), Hellbores (E10.44) and PPDs (E11.332).

**(D4.221)** For each damage point of the volley, roll two dice and find the resulting number in the "die roll" column of the DAMAGE ALLOCATION CHART (D4.21).

**(D4.222)** Look across (to the right of) the die roll result, and note the system listed in column "A." Normally, the damage point in question is scored against one box of that type. Players must allocate EACH damage point of a given volley by this procedure. However, if there are no remaining boxes of that type on the target ship's SSD (or never were any), move one column to the right and score the damage point against the system listed in column "B." If there are no undestroyed boxes of the system type listed in column "B," move on to column "C" and so on. See (D4.323) and Annex #7E.

**(D4.223)** When a particular system is determined to have been hit, the player owning the target ship MUST mark one of the boxes on his ship identified as being that system as destroyed. [Exception: Phasers can only be destroyed from a direction in which they can fire; see (D4.321), which has numerous exceptions of its own.] Thereafter (unless repaired), that system box does not exist and cannot be used.

**EXCEPTIONS:** Power-generating systems will continue to generate power until the end of the turn (H1.0) on which they are destroyed unless using (D22.0). The restrictions caused by lost control boxes (G2.2) do not apply until the end of the turn. A reduced sensor rating (D6.11) will not be used for a general lock-on until the first of the next turn. Plasma torpedoes can be fired up to 8 impulses after the launcher is destroyed (FP1.7).

**(D4.23) SPECIAL CASES:** Several special and/or non-ship units do not use the Damage Allocation Procedure in (D4.0). The damage procedure for these units is given in their respective rules.

Fighters and shuttles are described in (J1.32).

Drones are described in (FD1.54).

Plasma torpedoes are described in (FP1.6).

PFs and Interceptors use a modified form of (D4.21) presented in (K5.0).

Small ground bases, listed in (R1.14) and in (R1.28), use the procedure in (R1.14).

Mines are destroyed by the procedure in (M8.4).

Starbases use a modified form of the procedure; see (R1.1D).

Bases (with some exceptions) have a minor exception in the case of their warp reactors in (H4.32).

Several individual units have special or unique provisions noted in their unit descriptions.

#### **(D4.3) DAMAGE ALLOCATION RESTRICTIONS AND CONDITIONS**

Several conditions, restrictions, and special rules are involved in the Damage Allocation Procedure.

**(D4.31) BOLD-FACE RESULTS:** Note that some of the results on the DAMAGE ALLOCATION CHART (D4.21) are printed in BOLD type. These results are treated specially. A given BOLD result can only be scored ONE time in each volley.

For example, if three damage points were scored, and the allocation die roll was a "12" in each case (unlikely, but possible), then these three damage points would be scored against: auxiliary control, emergency bridge, and scanners. If the three allocation die rolls had all been "9," then the damage points would have been scored against left warp engine, forward hull, and forward hull boxes. Note, however, that the prohibition against scoring a BOLD result twice is against the position of the chart, NOT against the given system. If allocation die rolls of "10" and "4" were obtained, both would be scored against phasers. (This example assumes that the ship in question has the systems in question.)

#### **(D4.32) SPECIAL WEAPONS CONDITIONS**

**(D4.321) PHASER DIRECTIONAL HITS:** In the case of hits against phasers, the hit must be scored against a phaser that is capable of firing in the direction from which the volley came (i.e., through the shield in the case of seeking or enveloping weapons, or of firing at the firing unit in the case of direct-fire weapons). See also (D4.34). See (C6.5423) for another special case. See (C6.555) for additional damage that is part of the same volley.

ONLY phasers use the "directional" rule for damage allocation.

**EXAMPLE:** If a Federation heavy cruiser in hex 0619 (facing A) was hit from the direction of hex 0719 and a phaser damage point was called for, the owning player could mark this damage point against either a forward or right phaser, since these could fire in this direction. (The refitted Federation CC has four phasers in the secondary hull with 360° traverse. These phasers could fire in this direction and could be destroyed on this damage point if the target was a CC.) However, the damage point could not be scored against the left phasers (which cannot fire in that direction) since the hull protects these from the blast.

If such a hit cannot be scored against a phaser bearing in that direction, it is then (and only then) scored against the system in the next column of the DAMAGE ALLOCATION CHART (D4.21).

Hits designated as "any weapon" may be scored against phasers regardless of direction.

Internal explosions (shuttle bays, hangars, etc.) ignore phaser directional damage restrictions.

See the following special cases:

Hellbores (E10.43) and (E10.7).

Plasmatic Pulsars (E11.332).

Power absorbers (D10.15).

Enveloping plasma torpedoes (FP5.32).

**(D4.322) MULTIPLE WEAPONS:** In the case of ships with several similar weapons, at least some of the damage must be scored on the better weapons. See (G17.52) for hastily repaired systems.

**(D4.3221) PHASERS:** Each third phaser hit in a given volley must be applied to the best available type, assuming the specific phaser can be hit from that direction. See Annex #7E for priority.

No more than one damage point per volley can be scored on a stasis field generator. An "any weapon" hit may be scored on an SFG (and must be if that is the last weapon) even if that SFG had taken damage earlier in the volley.

**(D4.3222) TORPEDOES:** Ships with several types of a given torpedo must score every third torpedo hit against the most powerful type on the ship in a cumulative record over the entire scenario. See Annex #7E for priority.



**(D4.3223) DRONES:** Ships with several types of a given heavy weapon destroyed by drone hits must score every third drone hit against the most powerful type on the ship in a cumulative record over the entire scenario. See Annex #7E for priority.

**(D4.323) ALTERNATE HIT RESULTS:** The result "TORP" on the DAMAGE ALLOCATION CHART is applied to disruptor bolt, photon torpedo, plasma-D racks, fusion beam, TR beam, and plasma torpedo boxes on the SSDs.

The result "DRONE" on the DAC is applied to drone racks, PPDs, web casters, hellbores, ESGs, Andromedan PA panels, and anti-drones. There are some additional exceptions noted in various rules sections. See also Annex #7E.

**(D4.324) ANY WEAPON HITS:** An "any weapon" hit may be scored on a non-weapon system that is listed to be destroyed on a specific weapon hit (e.g., PA panels, in Module C2, are destroyed on drone hits) if the owning player so chooses. He is not required to do so. An "any weapon" hit could be scored on a shuttle bay occupied by a shuttle or fighter, but this isn't required.

An "any weapon" hit can only be taken on a weapon box on the ship portion of the SSD (as per the rules). It cannot be scored on a boarding party, crew unit, deck crew, cloaking device, shuttle damage point, or ammunition (individual probe, drone, PPT, etc.) track.

An "any weapon" hit MUST be scored if there is a system on the ship which can be scored by that damage point, including non-weapon systems which are destroyed on weapon hits (for example, PA panels destroyed on drone hits). The "voluntary" nature of such action is limited to the fact that an actual weapon could be destroyed instead. If the non-weapon systems are the only qualifying system boxes on the ship, the damage point MUST be scored there. See Annex #7E.

**(D4.325) SHUTTLE HITS:** A shuttle hit can be scored on a shuttle or fighter box. The exact box chosen is up to the player, but if it contains a shuttle, that shuttle is also destroyed. The owning player can score the damage point on any shuttle box on his ship at his option; exception, see (J1.631) for enemy shuttles on board a ship. See also (D12.0) for chain reaction explosions in a shuttle bay.

**(D4.326) SCOUT SENSORS:** See (G24.17) for procedure.

**(D4.327) STASIS FIELD GENERATORS:** See (G16.52).

**(D4.33) SPECIAL FUNCTION TRACKS:** The last box on the sensor, scanner, and damage control tracks is NEVER marked as destroyed. This represents the residual capability (if any) existing after the system has been effectively destroyed. When marking hits on these tracks, the HIGHEST number on the track (on the top or left end, not necessarily a larger number) is the one that is marked. Players cannot select another (presumably lower) number on that track to mark. The boxes on the various tracks must be destroyed (by the DAC) in order, from best to worst (top to bottom or left to right).

**(D4.34) MULTI-SHIP VOLLEYS:** It is possible for a volley striking a given shield during a given impulse to include hits scored by two enemy units firing from two slightly different directions. This causes a problem when "phaser" hits (which have a directional restriction) must be resolved. In such a case, first resolve the damage points from the unit which caused the most damage, then from other units in the order of the damage they caused. (If two or more units caused equal damage, toss a coin or roll a die to determine which to resolve first.) The volley is still resolved as a single volley; this procedure governs only the direction of fire for the phaser hit restriction. This procedure is also used if multiple volleys strike a given target from multiple directions on the same impulse. The larger volley will be resolved first. If two (or more) volleys are equal, roll a die to determine which volley struck first.

**(D4.35) SPECIFIC DAMAGE:** When the DAMAGE ALLOCATION CHART (D4.21) calls for damage to a system not installed on a given ship, go to the next column. Do not disregard the left/right or forward/aft designations.

**(D4.351) HULL HITS:** There are three types of hull on ships in Star Fleet Battles. All hull boxes on all SSDs are marked as one of these three types.

Forward hull boxes may be designated "F HULL" on the SSD or simply "HULL" with an "F" in one box. These are destroyed by "Forward Hull" hits. Aft hull hits cannot be scored on forward hull boxes.

Aft hull boxes may be marked "A HULL" or "R HULL" or have an "R" in one box. These are destroyed by "Aft Hull" or "Rear Hull" hits. Forward hull hits cannot be scored on aft hull boxes.

Center Hull boxes may be designated "C HULL" on the SSD or simply "HULL" with a "C" in one box. These can be destroyed by forward hull hits and/or by aft hull hits. If a player has only center hull remaining, he must score any F or A hull hits on center hull boxes; he cannot choose to ignore them.

Most ships have two groups of hull boxes, one marked forward and the other aft. Some ships (e.g., Tholian PC) have only one group; this will be marked C HULL. Some ships (e.g., Gorn CA) have three groups (forward, center, aft).

Some ships (e.g., Kzinti CV) have two groups with the same designation (rear hull in this case) that are in an identical position with respect to forward and aft, but in opposite positions (right vs. left) with respect to longitudinal symmetry. Such groups are considered to be the same; they are drawn in this way only for artistic purposes in making the SSDs as symmetrical as possible.

Most Lyran ships have forward hull in the left side of the ship and aft hull in the right side. Some Lyran ships also have center hull sections which are treated as C HULL.

Many small ships have only C HULL. Some fairly large ships (e.g., most of the Hydrans in Module C1) have only C HULL. This is known as "unified hull" and allows the ship to absorb considerable amounts of damage before losing key systems.

Barracks (G28.0) and Repair (G17.0) are also destroyed by hull hits. If a ship has either of the acceptable types of hull and one of the systems listed on Annex #7E, the hit must be scored on one of them.

**(D4.352) ENGINE HITS:** In some cases the warp engines on an SSD are not specifically marked as "left" or "right." If the ship has two warp engines, they are "left" and "right." If the ship has three warp engines, they are "left," "right," and "center." If the ship has one warp engine, it is "center." Each type of warp engine is distinguished on the DAC; do not disregard the left, right, and center designations.

**EXAMPLE:** Do not score "left engine" or "right engine" hits on a Federation destroyer on the one engine (which is a center engine) as this will make the ship run out of engines three times as fast as it should. As the Federation DD does not have left or right engines, you proceed to the next column on the DAC.

**EXCEPTIONS:** Monitors (R1.22) have special warp engine damage rules. Center Warp hits on some bases are scored on warp reactors (H4.32).

**(D4.36) CARGO:** If undestroyed cargo spaces exist on a ship, excess damage hits may be scored against them at the option of the owning player. Also see (D4.40).

#### (D4.4) HOW SHIPS ARE DESTROYED

**(D4.40) ACT OF DESTRUCTION:** When there are no "excess damage" boxes remaining, and one additional excess damage hit is scored on the ship, the ship is destroyed. This final excess damage hit cannot be scored as excess damage so long as there is some other system (only: cargo, repair, mine rack) on which an excess damage hit can be scored by Annex #7E.

**(D4.41) REMOVAL FROM PLAY:** At the instant of destruction, the ship is removed from the game, all personnel on board are assumed to have perished, and the ship is considered destroyed for victory purposes. See (D4.42) in the case of any seeking weapons controlled by the destroyed ship. See (D21.0) and (G12.0) for optional procedures for possible escape by some of the crew.

**(D4.42) SEEKING WEAPONS CONTROL:** When a ship is destroyed, any seeking weapons that it is controlling are released (F3.4). If control cannot be assumed by another unit (or the weapon itself), the weapon will go inert.

**(D4.43) EXPLOSIONS:** Ships explode at the instant of destruction. See (D5.12).

#### (D4.5) EXAMPLE OF SHIELD OPERATION AND DAMAGE ALLOCATION

During the Energy Allocation Phase, the captain of a Klingon D7 battlecruiser has placed his shields on full power (using 2 energy points), reinforced his forward shield (#1) with 10 units of power, and put 8 units of power into general reinforcement (which will provide 4



**(D5.1) DECLARING SELF-DESTRUCTION**

A player may only declare self-destruction at the start of a turn after the other players have completed their Energy Allocation Forms. When a player decides to destroy his ship, he simply marks the Energy Allocation Form for that turn "self-destruct;" he is generally not required to fill it out (and there would be no point). He does not make any other entries [see (D5.15) for possible exceptions], and the ship can do nothing except execute the self-destruct order. Self-destruction takes place in the Self-Destruction Phase (#3) of the turn. See (C13.4812) for internally docked units.

**(D5.11) POSSIBLE INTERRUPTION:** Self-destruction automatically takes place, unless the captain is not in control of his ship; see (G6.41) mutiny and (D7.7) boarding parties.

**(D5.12) EXPLOSION:** When a ship is destroyed in combat (D4.40), it explodes immediately. The self-destruction procedure is used to determine the extent of the explosion. The force of the explosion is found on Annex #3 Master Ship Chart. The listed explosion strength on the Master Ship Chart is not modified by the existence or non-existence on the unit of any unexpended weapons (including mines or drones).

**(D5.13) UNITS USING THIS PROCEDURE:** This procedure is used for ships (including PFs and bases). Fighters, seeking weapons, mines, and small ground bases (P2.76) DO NOT explode when destroyed.

**(D5.14) ESCAPE:** In the case of destruction in combat, units could attempt to escape (D21.4). If a section separates, deduct its explosion strength from the strength of the basic unit.

**(D5.15) ENERGY FORM:** There are some cases in which the ship could be required to complete its Energy Allocation Form. These include:

**(D5.151)** If there is a possibility that self-destruction may not be successful (mutiny, etc.). In this case, the EA Form is completed normally.

**(D5.152)** A computer-controlled ship asks for the speed of the ship. The form must be completed normally so that the question can be answered.

**(D5.153)** The ship is involved in a tractor auction. In this case, the ship cannot bid more than six points of power or more power than it has.

**(D5.154)** The player is required to reveal his EA Form (whether it was filled out or not) to show that it is marked "Self-Destruct."

**(D5.2) SELF-DESTRUCTION FORCE**

When a ship self-destructs, or receives an "excess damage" hit after all excess damage boxes are destroyed, it explodes. The force of this explosion is specified on the Master Ship Chart. The explosion strength of Orion ships includes their nuclear suicide bombs. The explosion value of a ship is not reduced if it drops or has dropped its warp engines. The explosion value of a PF is not reduced if it drops or has dropped its warp booster packs.

Add to this number the explosion strength of any unit docked to or inside the exploding unit, unless that docked unit escapes via (D21.5). See (C13.43), (C13.66), (C13.74), (C13.942), and (G19.3). Do not add the explosion strength of bases to which the exploding ship is docked. This rule does not apply to two ships docked by (C13.9).

**(D5.3) MULTIPLE EXPLOSIONS**

**(D5.31) SHIP IN SAME HEX:** If another ship is in the same hex as the exploding ship and is destroyed by the explosion, add its basic explosion strength to the basic explosion strength of the original exploding ship and treat them as a combined explosion (since the ships blew up virtually instantaneously). The shield facing of these other ships may need to be determined; see (D3.42).

This also applies to PFs in the same hex or docked to the exploding ship which did not escape under (D21.0).

**(D5.32) SHIP IN DIFFERENT HEX:** If a ship in another hex is destroyed by the explosion, count its explosion as a separate case.

**(D5.4) APPLICATION OF EXPLOSION STRENGTH**

**(D5.41) BASIC EXPLOSION STRENGTH:** The number determined in rule (D5.2) is the basic explosion strength (BES).

If the BES is 9 points or less, the explosion affects only the hex containing the exploding unit(s).

If the BES is 10 points or more it affects the hex containing the exploding unit(s) and the 6 surrounding hexes (radius one).

The BES is applied to every unit within the explosion zone on the shield facing the exploding unit(s).

**(D5.42) CLOAKING DEVICE:** Ignore cloaking devices in calculating for "self-destruction" blast effects. A cloaked ship receives damage from explosions as if it were not cloaked. The explosion of a cloaked ship is identical to that of an uncloaked ship. See also (G13.52).

**(D5.5) SELF-DESTRUCTION RESTRICTIONS AND CONDITIONS**

**(D5.51) CREW UNITS:** In multi-ship scenarios, a ship may not self-destruct unless all but two (or fewer) of its crew units have been killed or evacuated, including (D21.21). This restriction is ignored if there are more enemy than friendly boarding parties (including militia) on board or if there are no other friendly ships remaining in play. This restriction cannot be violated simply for the purpose of destroying nearby enemy units in the resulting explosion or for any other purpose.

Orions can ignore this restriction and self-destruct whenever they are in danger of being captured; see (G15.1) and (D1.52).

**(D5.52) ENEMY MARINES:** If enemy boarding parties are on board the ship, they may be able to prevent self-destruction. See (D7.7) and (D5.11). See also (D16.84) in Module M.

**(D5.53) KLINGON SHIPS:** If a mutiny has taken place on board the ship, or if the officers have separated the boom section, self-destruction might not be automatically successful. See (G6.41) and (D5.11).

**(D5.54) MOVEMENT PLOT:** If there is a possibility that self-destruction may not occur, and if pre-plotted movement is planned, a player plotting self-destruction must also plot his next turn's movement in case self-destruction is prevented. See (D5.15).

**(D5.55) BLOCKING EXPLOSIONS:** Note that planets block the effects of explosions (P2.547) and that webs limit their effects (G10.72). Ships docked to or in a base may be shielded to some extent from explosions or have their explosions partially blocked. See (C13.52), (C13.66), and (C13.74).

**(D5.6) CATASTROPHIC DAMAGE**

This rule number was originally used for the Catastrophic Damage system, and some references to this number still exist in older editions of the game. This section was completely replaced by (D21.0).

**(D6.0) FIRE CONTROL SYSTEMS**

Ships (and other units) use their sensors and scanners to detect, identify, and (sometimes) direct weapons to targets. The units in *STAR FLEET BATTLES* use a system functionally similar to 20th century radar (although operating on different principles because the ship and its target are usually moving faster than light).

Sensors and scanners operate in two modes (active and passive) simultaneously. In their active mode, they broadcast an electronic pulse which will be reflected back to the broadcasting unit by any target. In their passive mode, they search (without active broadcasting) for energy emissions from any potential targets. Computers

analyze the returns from both systems to gain information about the target. Certain types of known targets (asteroids, Klingon frigates, plasma torpedoes) have distinctive patterns that can be recognized.

The term "target" is traditionally applied to just about anything detected by naval/starship scanners, whether it is engaged by fire or not.

Electronic warfare is used to attempt to keep the enemy from gaining the full effect of his sensors.

### (D6.1) SENSORS

Sensors are the reconnaissance systems (similar to radar) of the unit. They are used to "lock-on" to targets.

**(D6.11) LOCK-ON:** Units must have a lock-on to their target to fire their weapons with their full effect. Units roll for lock-on in the Sensor Lock-On Phase of each turn, and possibly at other times. If the sensors are damaged during a turn, the unit does not roll again for general lock-on until the Sensor Lock-On Phase of the next turn. However, rolls required during the turn against a specific unit (perhaps one emerging from behind a planet or from a cloak) would use the current sensor rating (which might have been reduced by damage during the turn).

Roll a single die, and if the result is equal to or less than the sensor rating (the highest unchecked number on the sensor track of the SSD), the lock-on is achieved. Note that as almost all ships have a "6" in the first box of their sensor track (or an assumed rating of 6), until damaged, sensor lock-on is automatic.

Usually, a ship (or other unit) either has a lock-on to every potential target on the map, or to none of them, but some circumstances (planets, cloaking devices, and others) could result in having a lock-on to some ships but not others. A ship can drop all of its lock-ons (i.e., its general lock-on) whenever it wishes, but cannot drop lock-ons only to selected targets.

**(D6.111)** Some situations break lock-ons during the course of a turn. These include cloaking devices, planets, and others noted in their rules. If the circumstances under which a lock-on was broken or prevented change during the course of a turn, a new lock-on attempt may be called for by the relevant rules, for example (G13.332) in the case of cloaks or the standard (D6.113) in the case of a target which emerges from behind a planet.

**(D6.112)** The electronic warfare rules (D6.3) may reduce the "quality" of a lock-on (by reducing weapons effects) but will not break it. Cloaking devices (G13.0), whether or not they break a lock-on, can degrade the effects of various weapons.

**(D6.113)** A ship will, generally, only make one lock-on die roll per turn. Thus, a ship which failed its die-roll at the first of the turn could not achieve another one by deactivating and then reactivating its fire control. However, if lock-on is lost to a given target due to a terrain effect (e.g., the target went behind a planet), then a new lock-on would be rolled for (against that target only) when the target reappeared, using the current sensor rating (which might have been reduced by damage).

**(D6.114)** While lock-on is a function of Active Fire Control (D6.6), the two effects are not automatic. A given unit in relation to a given target could be in one of three states:

**(D6.1141)** Fire control active with a lock-on. This is the normal and most common status.

**(D6.1142)** Fire control active, but no lock-on to a particular target.

**(D6.1143)** Fire control inactive. By definition, there will be no lock-ons to anything [exception (G7.97) tractor beams]. In Basic Set this will preclude any firing. In Advanced Missions, the unit could use passive fire control (D19.0) to fire with reduced effect.

**(D6.115) EXAMPLE:** At the first of Turn #6, the Federation CA *Intrepid* has a sensor rating of 6 and a "general lock-on" to the other six ships (and the 27 assorted drones, shuttles, plasma torpedoes, etc. on the map). During Impulse #6, a Romulan KR cloaks, but the *Intrepid* rolls and retains a lock-on. During Impulse #7, a pesky Klingon frigate moves behind the planet Neptune and lock-on is lost. On Impulse #14, a hit-and-run raid destroys the top box on the *Intrepid*'s sensor track, and a lucky disruptor hit on Impulse #20 destroys the second, reducing the *Intrepid*'s sensor rating to 5. The *Intrepid* does NOT make a new "general lock-on" roll and retains its lock-on to the five ships (no lock-on to the frigate) and 27 other objects in play. As the lock-on equation to the Romulan KR has now

improved in its favor (due to the lower sensor rating), the KR demands a new "retain lock-on" roll (G13.332) which the *Intrepid* fails (due to the lower sensor rating). On Impulse #24, the frigate emerges from behind Neptune and the *Intrepid* rolls to get a lock-on, but fails with a die roll of 6. At the start on Turn #7, the *Intrepid* makes a roll for a general lock-on during the Sensor Lock-On Phase and rolls a 3, gaining a lock-on to everything (including the frigate) except the still-cloaked KR. The *Intrepid* could roll for lock-on to the KR under (G13.333) during the turn in the lock-on step of any impulse.

**(D6.12) EFFECTS OF FAILING TO LOCK-ON:** If a lock-on is not achieved, then the following restrictions are placed on the ship which failed to achieve lock-on.

These apply to a unit which failed the general lock-on roll at the start of each turn. If the unit lost lock-on to one specific target, then these effects apply only in regard to that target.

**(D6.121)** The failing unit may not launch seeking weapons; exceptions (F4.0) and (D19.22).

**(D6.122)** Any seeking weapon on the map controlled by the failing unit and targeted on an object to which the failing unit has no lock-on is released (F3.4).

**(D6.123)** The firing range to all non-locked targets for other weapons is doubled. This doubling refers to the true range, not the range after being adjusted for scanners (D6.21). If the effective range (after doubling for no lock-on and adding the scanner factor) is beyond the maximum range of the weapon, the weapon cannot fire. See also (D19.23) for passive fire control.

**(D6.124)** Certain systems cannot be used without a lock-on to their targets. These include: Aegis Fire Control (D13.23), Anti-drones (E5.14), DERFACS (E3.62), Displacement Devices (G18.13), Maulers (E8.15), PPDs (E11.15), Special Sensors (G24.18), Stasis Field Generators (G16.35), Tractor beams (G7.412), Transporters (G8.17) [Exception (G13.421)], UIMs (D6.5), Web Casters (E12.13), and Web Snares (E13.1). See also Annex #7P.

**(D6.125)** Many systems require a lock-on to function, and a lock-on cannot be achieved without active fire control. See (D6.62).

**(D6.126) OVERLOADS:** Overloaded direct-fire weapons may be fired at a target without a lock-on even if the effective range is beyond their (overloaded) range limit as long as the true range is within their (overloaded) range limit. Note that feedback for overloaded weapons functions entirely based on true range. This procedure is also used for cloaked ships during the fade-in/out process.

**(D6.1261)** When firing overloaded weapons at a target without a lock-on at an effective range that is beyond the maximum range for that weapon in overloaded mode (and assuming that the true range to the target is within the maximum range of the weapon), resolve it as follows:

**(D6.1262)** In the case of "probability of hit" weapons (photons, disruptors, PPDs, and hellbores) use the probability of a hit at the effective range, even if beyond the overload range limit. If a hit is scored, use the damage that would be scored at the true range.

**(D6.1263)** In the case of "range of effect" weapons (e.g., fusion beams, where the die roll determines the effect rather than a simple hit or miss), determine the non-overloaded damage at the effective range, then increase this damage by the overload rating (50% or 100% as applicable). For example, a fusion beam fired at a true range of 2 would have an effective range of 4. A die roll of 3 yields 2 damage points, increased to 3 points by the overload. [Phasers on X-ships (X0.0) can be overloaded and would be treated under this paragraph.]

**(D6.1264)** An overloaded weapon which was fired at feedback range but missed would not result in feedback damage.

**(D6.127) MINIMUM RANGE:** Some weapons have a minimum range (e.g., photons). These weapons cannot fire if the true range is less than this minimum, even if the effective range is in excess of the minimum due to sensor or scanner effects.

### (D6.13) OTHER SENSOR CONDITIONS

**(D6.131)** Units which have launched seeking weapons must attempt to achieve a lock-on to their target every turn that they have drones on the map. Failure to achieve a lock-on causes the weapons to be released (F3.4); they could be transferred (F3.5).

**(D6.132)** Sensors are used to control seeking weapons and to determine the number of seeking weapons that a given ship can control. See (F3.2).

**(D6.133)** Fighters and shuttles have an assumed sensor rating of 6. If crippled (J1.33), this is not reduced. This does not affect the number of weapons controlled; see (J4.24) and (J4.25).

**(D6.134)** Plasma torpedoes and ATG drones have an assumed sensor rating of 6.

**(D6.135)** Small ground bases have an assumed sensor rating of 6.

**(D6.14) ACTIVE FIRE CONTROL:** This rule was moved to (D6.6) to improve clarity and ease of use.

**(D6.15) PASSIVE FIRE CONTROL:** This is covered in (D19.0).

## **(D6.2) SCANNERS**

Scanners are the weapons sighting systems of the unit. They are used to aim and fire all direct-fire weapons.

**(D6.21) SCANNER ADJUSTMENT:** The scanner adjustment factor is the lowest numbered undestroyed box on the scanner track. This is initially "0" for most ships. When computing firing range, always add the scanner adjustment factor to the actual range in hexes [which may be doubled due to failure to achieve sensor lock-on (D6.1)].

**EXAMPLE:** A Klingon D6 battlecruiser is having a rather difficult time with a Kzinti strike cruiser. The D6 has taken two hits on its sensors (reducing this factor from 6 to 5) and three hits on its scanners (increasing this number from 0 to 3). The Klingon wishes to fire and rolls for sensor lock-on. He rolls a "6" and does not achieve lock-on. The true range is 3 hexes. This is doubled to 6, and then the scanner adjustment factor of 3 is added to that, resulting in an effective range of 9. At this range, the phasers of the battlecruiser will do little, if any, damage, although the disruptors will remain effective.

**(D6.211)** A cloaking device could increase the effective range by five more hexes (i.e., cloak and scanner are cumulative), and electronic warfare could reduce the effectiveness of the weapons.

**(D6.212)** Anti-drones are handled differently; see (E5.16).

**(D6.213)** A reduced scanner rating takes effect at the end of the Stage during which the damage occurred.

**(D6.22) NON-SHIP UNITS** have an assumed scanner rating of 0. This includes fighters, shuttles, seeking weapons, defense satellites, captor mines, small ground bases, and any other unit without an SSD on which a scanner rating is given. Any exceptions in future products will be noted in the relevant rules.

**(D6.23) UNAFFECTED SYSTEMS:** Some systems are not adjusted by the scanner rating, including tractors, transporters, maulers, and Stasis Field Generators. See Annex #7P.

## **(D6.3) ELECTRONIC WARFARE** *(Some elements are Commander's Level)*

These rules simulate the use of Electronic Counter Measures (ECM) and Electronic Counter-Counter Measures (ECCM). These are collectively known as Electronic Warfare (EW).

Some of these rules are used at all times as standard rules to explain such things as terrain effects (P0.0) and small target modifiers (E1.7). These "Standard" EW rules are marked as such in this section. It is not possible to play the game without them although in the simplest scenarios they will not be used.

The Primary difference between the "Standard" and "Commander's" EW systems is that ships can spend energy to gain EW points under the Commander's system and cannot do so under the Standard system. Other differences include:

USED under Standard System: Terrain (P0.0), Wild Weasels (J3.0), Small Target Modifiers (E1.7).

NOT USED under the Standard System: Built-in EW of units (D6.394) and (D6.393), ECCM of ATG drones (FD5.26), ECCM of plasma torpedoes (FP4.3), ECM drones (FD9.0), EW pods (J4.96), EW fighters (R1.F7), SWAC shuttles (J9.1), MRS shuttles (J8.4), any EW generated by a ship using power (D6.31).

Basically, ECM is an advanced form of jamming intended to prevent the enemy from targeting your ship, or at least reducing the effect of his fire. The broadcasting ship is sending false data signals, disguised to appear as the returning sensor emissions of the enemy ship or as passive emissions of a target. The sensor operator in the

enemy ship is confronted with not only a great deal of static, but with dozens of false targets (where none actually exists) which are indistinguishable from the real target. (One 20th century USAF pilot described it as "playing 'Space Invaders' on the enemy radar screen.")

ECCM is the application of additional power or technology to "burn through" this jamming and detect the actual target. The relative success of ECM and ECCM changes rapidly from one instant to the next. A target that is perfectly clear on the scanners may suddenly be obscured by static; another target hidden by static may suddenly become clearly distinguishable.

In *STAR FLEET BATTLES*, ECM and ECCM cannot "break" a "lock-on," but they can dramatically reduce the effectiveness of that lock-on. Even with electronic warfare, a unit must still have a lock-on to fire without penalty or guide seeking weapons, and even with a lock-on must still roll for a near miss (D6.36) by seeking weapons.

**(D6.31) GENERAL ELECTRONIC WARFARE:** EW points come from a variety of sources, and the total number of points any given unit has may change from time to time.

**(D6.310) GENERATION:** Ships may use energy for ECM or ECCM. The total amount of energy put into (allocated for) ECM and ECCM combined cannot exceed the highest unchecked number on the sensor track (usually 6). No more than this number of units of power can be allocated for EW during an Energy Allocation Phase. Additional power may be applied using reserve power during the turn; see (D6.312). Energy must be designated for use as ECM or ECCM at the time it is allocated (or when reserve power is committed).

**(D6.311) SCOUTS:** Ships with scout functions (G24.0) may use more power for EW. See the specific rules on this case.

**(D6.312) RESERVE POWER (H7.2)** may be used to increase ECM or ECCM strength during the Fire Decision Step of any impulse, but not in excess of the limits stated for total power applied. In such cases, the EW calculations must be made again at the time such power is announced.

A player could drop some active EW points (ECM or ECCM) and use reserve power to activate EW points of the other type. All ships have a number of "circuits" for EW equal to their sensor rating (which is usually six). Each can be used for ECM or ECCM, but not both at the same time. A given circuit can be changed from ECM to ECCM no more than once every quarter-turn, even if this creates a restriction which extends into the next turn. Since power allocated to EW cannot exceed the sensor rating (which is equal to the number of circuits), changing a circuit will require the use of reserve power to create a new EW point of the other type. If reserve power is used in the last 8 impulses to change a circuit between ECM and ECCM, that circuit is committed to the new mode into the first impulses of the next turn. If you want to use it for the other type, you can allocate power specifically to that type of EW, which won't become effective until the 8-impulse restriction has passed. The EW points bought with reserve power on the last turn will be lost at the end of that turn, however. You could allocate power to the same type of EW as the reserve power was used for, in which case it would be effective immediately, then switch with reserve power after the eight impulse delay.

See (D6.315) and (D6.316) in this section, (D10.73) for Andromedans, and (H7.33) for reserve power.

**(D6.313) RANGE:** The power of ECCM is not reduced over its effective range, which is 100 hexes (150 hexes for scouts). ECM has no range limit.

**(D6.314) SOURCES:** Electronic warfare points (ECM and ECCM) can come from any or all of the following five sources:

**(D6.3141) GENERATED:** Points received for power expended by the ship, known as "self-generated" points. The total of both ECM and ECCM cannot exceed the highest unchecked box on the sensor track (usually 6). Note that the total is 6; a ship cannot generate 6 ECM and 6 ECCM (or 6 ECM and 1 ECCM for that matter) at the same time. Fighter EW pods are not included in this section; see (J4.96).

**(D6.3142) BUILT-IN:** Points built into the unit and received automatically. These are listed in (D6.393) and (D6.394) and are not included in any other limit.

[Exception: PF swing points (K1.72) and Interceptor swing points (K3.72) ARE included in the #1 limit above. The Orion PF "Stealth" ECM points are not under (D6.3141).]

**(D6.3143) NATURAL SOURCES:** Points received from natural causes, such as asteroids (P3.0), erratic maneuvering (C10.0), atmospheres (P2.54), small target modifiers (E1.7), and certain terrain types (P0.0).

**(D6.3144) RECEIVED FROM LENDING:** This is limited to 6 ECM and 6 ECCM points from all sources (D6.392) including scouts (G24.21), a scout's own self-protection jamming (G24.28), SWAC (J9.1) or MRS shuttles (J8.4), Wild Weasels (J3.23), ECM drones (FD9.0), and EW fighters (R1.F7). See (J4.9) for additional restrictions on fighters. A unit can generate six points of EW and receive (from a scout) six points of ECM AND six points of ECCM.

**(D6.3145) RECEIVED FROM OFFENSIVE ECM:** Under rule (G24.219), a unit can receive (unwelcome and unwanted) "negative ECM" from one enemy scout. This is limited to 6 ECM points. This ECM is factored into the general EW equation between firing and target units.

**(D6.3146) FRIENDLY UNITS** ignore (D6.3141), (D6.3142), and (D6.3144), but not (D6.3143) or (D6.3145).

**(D6.315) ADJUSTMENT:** The power used by each unit for electronic warfare can be adjusted each impulse as part of the Fire Decision Step of the Fire Allocation Stage of the Impulse Activity Segment. This is done simultaneously by all players and is simultaneous with the decision on what weapons to fire and at what targets. Use written orders (or Command Cards) and expose them simultaneously (B2.4) if necessary. See (B2.3-6D).

Certain involuntary adjustments, such as terrain, and certain secondary affects resulting in adjustments, such as starting or stopping EM, are done at other points as covered in their respective rules.

The changed EW status takes effect immediately for the current Direct Fire Weapons Step and remains in effect (unless changed) for the remainder of the turn. Changes in the EW status during the Fire Decision Step can include:

- A. Dropping some or all of the EW points. These dropped points are then irrevocably lost [Exception: Andromedans (D10.73)]. Note that a ship may have been forced to drop some EW points by (D22.0) or may be doing so in order to switch some circuits (D6.312) from ECM to ECCM or vice versa using reserve power (or inactive power if Andro).
- B. Increasing ECM or ECCM with reserve power; see (H7.33) and (D6.312). So-called "swing points" which can be changed from ECM to ECCM or vice versa are declared in the Sensor Lock-on Phase (#4) at the start of a turn (or at the instant of launch in the case of MRS, SWAC, and PFs) and cannot be changed during the turn.
- C. An Andromedan ship could, under (D10.73), reactivate some of the inactive EW points in conjunction with dropping others under A above.

Note that because of the timing of this EW status adjustment, a player effectively cannot increase ECM in response to enemy increases in ECCM (or vice versa) before weapons are fired, nor can he cancel weapon fire after learning the new enemy ECM level. For example, a ship cannot allocate extra power for ECM after an enemy announces that weapons are firing because the EW adjustment decision is made before fire is announced.

**(D6.316)** As the unit has a limit on the total EW points, it may drop some or all of its self-generated (category #1) ECM to use additional ECCM and vice versa. This may be done during any impulse (D6.315), but no one circuit (D6.312) can be changed more than once in eight consecutive impulses, even if this creates a restriction which extends into the next turn. See (D10.73) for Andromedans.

**EXAMPLE:** If ECM is dropped on Impulse #7 so that ECCM can be increased, and later on Impulse #15 ECCM is dropped so that ECM can be increased, the ECM points dropped in Impulse #7 are not restored, but would have to be replaced with reserve power. Exception: Andromedans (D10.73).

**(D6.317) LENDING:** Various units have the capability to lend EW to other units; see (D6.3144). Most units (Scouts, MRS shuttles, SWAC shuttles, EW fighters, etc.) which lend EW to another unit are required to have a lock-on (D6.11) to the receiving unit.

Wild Weasels (J3.0) do not require a formal lock-on in order to "lend" their ECM to their launching ship. They are assumed to have such a lock-on.

ECM drones (FD9.0) do not require a lock-on in order to "lend" their ECM to their protected ship, but are assumed to have a lock-on.

**(D6.3171)** Subject to the additional restrictions in the specific rules of the lending unit, a unit which is receiving more than its limits of "lent" ECM or ECCM (D6.3144) may choose which ECM or ECCM points, and which lending sources, it will use. The remaining surplus points are ignored.

Exception: A WW (J3.0) will force the temporary suspension of other lent ECM points, but these will be restored to the receiving unit once the effects of the wild weasel have ended.

Exception: Offensive Electronic Warfare points (G24.219) cannot be ignored by the receiving unit (the target) voluntarily; they are not within the (D6.3144) limits.

**(D6.3172)** Unless otherwise required in their specific rules (such as an ECM drone losing lock-on to a cloaked target) or unless voluntarily dropped (if permitted), lending units from (D6.3144) will continue to lend their ECM or ECCM points to the receiving unit, even if the receiving unit, for whatever reason is unable to currently use them (e.g., the receiving unit moves out of range, the lending unit doesn't have a lock-on to the receiving unit, the receiving unit cloaks or launches a wild weasel, etc.). This does not apply to surplus points ignored under (D6.3171).

**(D6.32) ANNOUNCEMENT (Standard):** In the sensor lock-on segment of each turn, players announce their ECM and ECCM strength (the number of energy points expended).

This ECM and ECCM strength may change during the turn at various times for various reasons provided in the rules. Any change in ECM status is announced; (D6.315). The amount of ECCM a given unit is generating has to be announced if it has active fire control. Natural or built-in ECCM does not have to be announced, unless it exceeds what the unit is allowed to generate. If the unit does not have active fire control, the amount of ECCM it is generating is announced only if it activates its fire control and is revealed the instant the fire control is activated, but gains no benefit until the fire control is fully active.

Under the Standard system, the EW of ships must be calculated, although as there are fewer sources the calculation will be simpler.

**(D6.33) INTEGRATED EW EXAMPLE:** There are many EW functions taking place during the turn.

#### TURN #4

**ENERGY ALLOCATION:** A dreadnought pays 4 points of energy for 4 ECCM points. A cruiser pays 6 points of energy to buy 2 points of ECCM and 4 of ECM. A carrier pays 6 points for 6 ECM points. A destroyer pays 2 points of energy to buy 2 points of ECM. A scout pays 22 points for 6 ECM and 16 undesignated EW points. A frigate pays for 2 ECCM points. A police corvette pays for 2 ECM points.

**SENSOR LOCK-ON PHASE:** The ships announce their EW status. The scout announces that it is using its own 6 points of ECM plus 6 of its undesignated EW points for its own defense; using the extra 6 requires it to use a channel for self-protection. The scout announces and begins lending 2 ECCM points to the carrier, using 2 of his unallocated EW points and 1 of his channels. The fighter squadron (on the map from the previous turn) is noted as still receiving EW support from its own EW fighter (which is using its 2 internal EWPs to generate 4 ECCM and its 2 external EWPs to generate 4 ECM). It is assumed that the EW fighter remains within range of the fighters for the ensuing example. The carrier announces that it is generating 4 points for its fighters (even though they are not accepting it) and 2 for itself. The police corvette has its fire control in passive mode and has no lock-ons to anyone.

#### IMPULSE #6

**LOCK-ON STAGE:** The scout, which has a lock-on to the destroyer, uses 6 of its undesignated EW points and a powered but unused channel to begin lending 6 ECM points to the destroyer.

#### IMPULSE #7

**VOLUNTARY MOVEMENT SEGMENT:** The frigate, which fears attack, begins moving through the asteroid field. As it does so, it gains various amounts of ECM from the asteroid hexes between itself and any potential attacker. Since the asteroid field is irregular and the potential attackers are moving in various directions, it would be impossible to give a detailed example, but suffice it to say that any potential attacker can calculate the EW effect at the point of firing. (Of course, the frigate would also have an ECM penalty if firing at those attackers.)

**SEEKING WEAPONS STAGE:** The cruiser launches an ECM drone to protect itself.

**SHUTTLE AND PF FUNCTIONS STAGE:** The DN launches its MRS.

**IMPULSE #8**

**VOLUNTARY MOVEMENT STAGE:** Finding the battle intensity increasing, the fighters turn and head toward their carrier.

**SEEKING WEAPONS STAGE:** Desperately trying to escape a pursuing force, the EWF drops the 2 external EWPs to gain speed; the EW status of the fighter squadron is adjusted (and not favorably) immediately. The EWF had set up its EWPs in this manner so that the ECCM would remain effective while the drones pursued the target.

**IMPULSE #10**

**VOLUNTARY MOVEMENT:** The frigate moves closer to an admin shuttle it had been intending to kill.

**SEEKING WEAPONS STAGE:** The admin shuttle, which was a scatter-pack, releases 6 drones targeted on the frigate.

**ACTIVITY SEGMENT FINAL FUNCTIONS STAGE:** The frigate declares emergency deceleration.

**FIRE ALLOCATION STAGE:** The destroyer wants to fire at the cruiser before its ECM drone becomes active on Impulse #11. The destroyer secretly commits 2 points of reserve power to ECCM in order to reduce the ECM of the cruiser and gain a better shot (only a +1 shift instead of +2), and commits to fire all 4 photons at the cruiser. However, the cruiser captain had secretly designated to drop his 2 points of ECCM and use 2 points of reserve power to increase his ECM to 6, retaining the +2 shift.

**DIRECT-FIRE WEAPONS STAGE:** The destroyer's photons, fired with the +2 shift on the die roll, all miss the cruiser.

**IMPULSE #11**

**LOCK-ON STAGE:** The police corvette, which turned its fire control off on Impulse #11 of the previous turn, gains 2 points of ECM from the passive fire control benefit. The ECM drone launched by the cruiser on Impulse #7 starts broadcasting ECM points.

**DIRECT-FIRE WEAPONS FIRE STAGE:** The dreadnought targets the ECM drone with a concentrated phaser barrage, killing it. (The DN had to overcome the small target modifier and the drone's own ECM; it used its own ECCM plus that from the MRS to do so.) The cruiser loses the effect of the drone's ECM at the end of the Direct-Fire Weapons Segment.

**IMPULSE #12**

**FINAL MOVEMENT ACTIONS STAGE:** The frigate comes to a halt with the emergency deceleration it declared on Impulse #10.

**SHUTTLE AND PF FUNCTION STAGE:** The frigate, now at speed zero, launches a wild weasel at a speed of five in order to exit the hex of the FF before seeking weapons hit it, gaining 6 points of ECM and shutting down his active fire control system. This causes him to lose (temporarily) the 2 ECCM points as they cannot be used without active fire control.

**IMPULSE #14**

**VOLUNTARY MOVEMENT STAGE:** Six drones enter the hex of the WW, destroying it. The collateral damage destroys three other drones in the hex en route to another target. Five more drones are "in flight" and targeted on the frigate; they were distracted by the WW and are now targeted on the explosion hex.

**INITIAL STAGE OF IMPULSE ACTIVITY SEGMENT:** The frigate activates his fire control. Because the WW is in the explosion period, this does not void it, but the active fire control won't be effective until Impulse #18.

**IMPULSE #15**

**VOLUNTARY MOVEMENT STAGE:** Three of the five drones pursuing the WW reach the explosion hex and detonate, causing more collateral damage (although there is nothing there to damage).

**LOCK-ON STAGE:** The dreadnought's MRS shuttle, launched on Impulse #7, begins lending 2 ECM and 4 ECCM points to the dreadnought in Step (6B8) having been released from the (J1.343) restrictions. The fighter squadron, now within range of its carrier, announces a change; they will begin accepting lent EW from the carrier rather than their EWF (they can only accept this from one source at a time) because the carrier can offer 4 ECM (6 with reserve power) while the EWF can offer nothing. Each fighter, of course, also has its own 2 points of ECM so they can only accept 4 of the points from the carrier.

**DIRECT-FIRE WEAPONS FIRE STAGE:** The dreadnought's MRS is destroyed by a disruptor narrow salvo; the dreadnought loses the effect of the ECM it had been receiving at the end of the Direct Fire Segment. The frigate fires two phasers on passive fire control to kill a fighter that is facing a down shield. This voids the WW.

**IMPULSE #16**

**VOLUNTARY MOVEMENT SEGMENT:** The last two drones, ignoring the voided WW, begin pursuing the frigate.

**FINAL MOVEMENT ACTIONS STAGE:** The destroyer announces that it is beginning erratic maneuvers.

**DIRECT FIRE WEAPONS FIRE STAGE:** The cruiser fires at the destroyer, which does not receive the benefit of its erratic maneuvers.

**POST COMBAT SEGMENT:** The destroyer receives the benefit of its erratic maneuvers.

**IMPULSE #17**

**VOLUNTARY MOVEMENT STAGE:** The destroyer moves into a hex behind the planet from the scout; the scout loses lock-on, and the ECM being lent is lost to the destroyer. The fighters, sensing the tide of battle turning in their favor, turn toward the enemy.

**DIRECT-FIRE WEAPONS FIRE STAGE:** The frigate fires on the pursuing drones, but because fire control still is not fully active, he scores few hits.

**IMPULSE #18**

**VOLUNTARY MOVEMENT STAGE:** Drones targeted on two of the fighters enter their hex in a head-on approach. Drones targeted on the frigate strike it on the #3 shield.

**DAMAGE DURING MOVEMENT STAGE:** The drone hits on the two fighters are resolved. The fighters, still receiving the benefit of the carrier's ECM, survive (barely) when the EW shift causes the drones to do less damage. The drone hits on the frigate are resolved, collapsing the #3 shield and causing some internal damage.

**INITIAL STAGE OF IMPULSE ACTIVITY SEGMENT:** The frigate's fire control is now fully active, and it has regained the 2 points of ECCM, but it has no working weapons left available to fire.

**IMPULSE #19**

**VOLUNTARY MOVEMENT STAGE:** The fighters, having moved beyond EW lending range of their carrier, lose this benefit immediately. They would like to begin receiving ECCM from their EWF, but cannot do so because they cannot change their one source of lent EW until Impulse #23 (i.e., 8 impulses after the previous change). Drones targeted on 2 more of the fighters enter their hex in a head-on approach.

**DAMAGE DURING MOVEMENT STAGE:** The drone hits on the 2 fighters are resolved. The fighters do not have the benefit of the carrier's ECM and are destroyed.

**IMPULSE #21**

**SEEKING WEAPON STAGE:** The surviving fighters launch drones.

**IMPULSE #23**

**VOLUNTARY MOVEMENT STAGE:** The cruiser, with 6 ECM active, turns to enter the hex of the oncoming drones. This was done because the fighters will gain the ECCM benefits of the EWF later in this impulse. By moving to allow his ship to be hit now, rather than on the next impulse, the cruiser captain has mitigated the damage to some extent by arranging a favorable EW shift. (It can be presumed that the cruiser had no way to avoid being hit, and that it used its phasers and tractors during Impulse #22 to stop at least some of the drones.)

**DAMAGE DURING MOVEMENT STAGE:** The drone hits on the cruiser are resolved. Because the cruiser had 6 ECM and the fighters had only their 2 inherent points of ECCM, the shift was 2 (square root of 4) and the damage is reduced to some extent.

**IMPULSE #24**

**VOLUNTARY MOVEMENT STAGE:** The destroyer moves out from behind the planet, the scout regains lock-on, and the original ECM points lent to the destroyer are regained. This would not have been true if the specific sensor channel had been destroyed, blinded, or shut down.

**(D6.34) CALCULATION OF EFFECT (Standard):** To determine the net effect of ECM and ECCM, make the following calculation:

**STEP 1:** Determine the ECM strength of the target unit (D6.314). This may be adjusted (usually increased) by various factors, including ECM drones (FD9.0), SWAC shuttles (J9.0), scouts (G24.0), or other means. Note that some units have an additional ECM strength built-in due to their design; see ship descriptions. Also note that certain objects, such as terrain (P0.0), can produce an ECM effect.

**STEP 2:** Determine the ECCM strength of the firing unit. In the case of seeking weapons, this is the ECCM strength of the unit guiding the seeking weapon and/or the ECCM strength of the weapon itself (if any). Note that some units have an automatic built-in ECCM strength in addition to any power they apply. The ECCM of the guiding unit, plus any ECCM from the weapon itself, is used in determining the effect of this chart. The guiding unit cannot provide ECM to the weapons.

**STEP 3:** Subtract the ECCM strength of the firing unit from the ECM strength of the target unit.

**STEP 4:** If the result of #3 is a negative number or zero (the ECCM is stronger than or as strong as the ECM), there is no electronic warfare effect and the rest of the calculation is skipped. **EXCEPTIONS:** Negative EW modifiers are used in the case of cloaks (G13.33), elite crews (G21.211).

**STEP 5:** If the result of #3 is a positive number, use it to determine the "net ECM shift" from the chart below:

Net ECM Strength (result from #3)	Net ECM Shift
1-3	1
4-8	2
9-15	3
16-24	4
25-35	5
36-48	6
49-63	7
64-80	8
81-99	9
100-120	10
121-143	11
144-168	12
169-195	13
196-224	14

Players may recognize this calculation as taking the square root and dropping all fractions. While the chart only goes to 224 points, the effect goes to infinity and higher levels can be calculated if needed, but it will be virtually impossible to exceed the chart.

**(D6.35) EFFECT ON DIRECT-FIRE WEAPONS:** In the case of direct-fire weapons (E0.0), the effect of ECM/ECCM is determined at the instant of firing. Electronic warfare produces a die roll shift; see (E1.8).

**(D6.36) EFFECT ON SEEKING WEAPONS:** In the case of seeking weapons (F0.0), the effect of ECM/ECCM is determined when the weapon reaches its target. The ECM shift is used to adjust the die roll on the table below:

**(D6.361) PROXIMITY OF DETONATION TABLE**

Die Roll	Effect on Seeking Weapon
1-6	Warhead 100% strength
7-8	Warhead 50% strength
9-10	Warhead 25% strength
11+	Warhead 0% strength

**(D6.362) PROCEDURE:** Whenever a seeking weapon enters the hex of its target, roll a single die to determine the proximity of detonation (i.e., the effect of the warhead). If there are any ECM shifts, they are added to this die roll. A result over 6 means, in effect, that the weapon exploded at some distance from the ship rather than against its shields. Note that if there is no ECM shift, or if players are not using the ECM rules, the only possible result is a normal (100%) detonation.

**EXAMPLE:** A drone, fired by a Kzinti ship, has reached the hex of its target, a Klingon D7. The net ECM shift at the time of arrival is +2. (The Klingon is using a lot of power for ECM.) The Kzinti player rolls a die; the result is "5." The ECM shift is added, yielding a "7" and indicating that the drone does only 50% of the normal damage.

**(D6.363)** This system is used for all seeking weapons, including drones, suicide shuttles, and plasma torpedoes. Even when using this system, a seeking weapon will not damage any ship other than its target.

**(D6.364)** If the target is cloaked, use the table in (G13.37) instead of the Proximity of Detonation Table.

**(D6.37) OTHER SYSTEMS AFFECTED (Standard):** Certain non-weapons systems also require a positive lock-on, and certain weapons do not operate in a manner that is suitable for (D6.35) or (D6.36). Note that after a tractor beam is attached, a lock-on (by the tractor and to the tractored unit) is automatic (G7.412). See also (D6.62).

**(D6.371)** This procedure is used for the following systems: displacement devices, tractor beams, transporters, and stasis field generators. See Annex #7P for an updated list.

**(D6.372) PROCEDURE:** For each individual action (i.e., for each of three transporters used on the same impulse), roll a single die and add the net ECM shift to the result. If the total is more than 6, the lock-on is not strong enough and the system cannot be used. If an unsuccessful attempt is made, another attempt with that same specific system box cannot be made on the same turn or within eight impulses (i.e., the standard rate of operations rule for most systems). Thus, you could make as many transporter attempts as you have transporters, assuming all were powered, but each could only make one attempt. Any energy allocated to a failed attempt is lost, and that item cannot be operated again on that turn (as per rules).

**EXAMPLE:** A Klingon ship wants to use its stasis field generator to place a Federation ship in stasis. At the instant the attempt is made, the Federation ship has a net ECM shift of +2. The Klingon player rolls a die and gets a result of "5" to which the shift is added for a result of "7." As this is greater than 6, the SFG cannot be used at this time, but another attempt (with the same SFG) could be made later in the turn since each SFG can generate three fields at a time (each field making one attempt per turn). If the Klingon ship has two or more SFGs, it could also make another attempt (on a later impulse) with the other SFG. Generator/fields which make a failed attempt cannot be reused until the next turn (i.e., the normal operations rate). Any EW change will not affect an existing SFG field.

**(D6.373)** See (D6.3146) for actions between friendly units.

**(D6.38) SYSTEMS NOT AFFECTED:** The following systems are not affected by electronic warfare: anti-drones, labs identifying drones, type-VI (dogfight) drones, all explosive mines (detection of targets is not effected by EW; captor mines firing at targets are affected by EW), sensor lock-on, scanner ratings, ship explosions, most monsters (D6.397), and expanding sphere generators.

**NOTE:** Cloaks have some aspects of EW, but their interaction with the above is defined by the cloak rules.

**(D6.39) OTHER EFFECTS OF EW**

**(D6.391) WILD UNITS:** Wild weasels (J3.23), wild PF scouts (K1.756), and wild SWACS (J9.2) affect seeking weapons independently of ECM/ECCM. The ECM points produced by WWs or wild SWACs do not protect the shuttle itself.

**(D6.392) SCOUTS:** Scouts (G24.0) may "loan" ECM or ECCM to another ship (G24.21). No more than 6 units of ECM and no more than 6 units of ECCM may be received (D6.3144) by any unit from all outside lending sources, such as scouts, MRS or SWAC shuttles, ECM drones, or wild weasels (J3.23). ECM points from natural sources (D6.3143) are not included within this limit. EW produced by the ship itself is not included within this limit.

**(D6.393) BUILT-IN ECCM:** Certain units have built-in ECCM. This includes:

- Plasma torpedoes [which have three points, see (FP4.31)];
- and fighters (J4.47), PFs (K1.71), interceptors (K3.71), and ATG drones (FD5.26), all of which have two.

See (D6.3142). The ECCM of seeking weapons is cumulative with the ECCM of the controlling unit and is announced on impact.

**(D6.394) BUILT-IN ECM:** Certain units have built-in ECM. These are specified in the ship specifications, but are primarily Orion ships. See (D6.3142).



Most Orion ships have built-in ECM due to their stealth design (G15.8); these are noted on their SSD.

All fighters have two points of ECM built-in (J4.47).

PFs do not have built-in ECM (Orion PFs have the Orion "stealth" ECM above). PFs do have the two points of built-in ECCM and two "swing" points of EW (used as either ECM or ECCM) for a total of four EW points as defined in (K1.7). See (K3.7) for interceptors, which are a small type of PF and have the same points.

Note that many of these are "small targets" which gain extra ECM through (E1.7), and that most units can gain ECM through Erratic Maneuver (C10.42).

**(D6.395) FIGHTERS:** Fighters can gain extra ECM and ECCM by way of special pods (J4.96).

**(D6.396) DOGFIGHT:** EW has no effect in a dogfight (J7.0).

**(D6.397) MONSTERS:** EW has no effect on monsters unless the special rules for a given monster say otherwise.

**(D6.398) EXPLOSIONS:** Ignore the effects of EW when calculating the effects of a self-destruction blast.

**(D6.4) NON-VIOLENT COMBAT (Optional)**

The highest principles of the Federation call for the absolute minimum loss of sentient life. Because of this, Star Fleet has developed a computer system for its weapons control computers which carefully directs fire against only the weapons stations and engines of the opposing ship. It is felt that the opposing ship will always be the aggressor (in strategic terms, anyway) and that simply destroying its weapons systems will be sufficient to force it to retreat.

Any ship's captain can decide to use the non-violent combat options. (No player may ever be forced to use this system against his wishes unless directed to do so by the scenario.) This decision is made at the start of the scenario. In fleet scenarios, all ships on one side of the same race must use the same system. (Very few players use this alternative, although it has considerable value in piracy.) Once the decision is made to use the non-violent options, the player cannot change his mind during that scenario. Refer to the NON-VIOLENT COMBAT OPTION DAMAGE ALLOCATION CHART (D6.41), using it instead of the regular DAMAGE ALLOCATION CHART (DAC).

**(D6.41) NVC DAMAGE ALLOCATION CHART**

DIE ROLL	EFFECT
1	Weapons hit, see chart (D6.411)
2	Power system hit, see chart (D6.412)
3,4,5	Miss — no effect
6	Random hit, use normal DAC

The above chart is used to distribute hits that have previously penetrated shields, armor, or PA panels.

A Legendary Weapons Officer (G22.74) modifies this die roll.

**(D6.411) WEAPONS SYSTEM HITS CHART (use two dice)**

DIE ROLL	EFFECT
2	Bridge (or any control system)
3	Scanner
4	Torpedo Hit
5,6	Miss — no effect
7	Phaser
8,9	Miss — no effect
10	Drone Hit
11	Sensor
12	Bridge (or any control system)

**(D6.412) POWER SYSTEM HITS CHART (use one die)**

DIE ROLL	EFFECT
1	Impulse engine
2	APR
3,4	Warp engine
5,6	Miss — no effect

**(D6.42) OTHER HITS:** Hits on systems that are not installed on a given ship or have already been destroyed are considered to be misses [see (D6.411), (D6.412), Non-Violent Combat].

A "Bridge" (or any control) hit causes one crew casualty. Other hits (except the random hits) do not cause crew casualties.

Legendary Officers on board the ship may be killed or disabled (G22.134).

**(D6.43) EXCLUSIVITY:** All weapons of any ship using this rule (with the exceptions of seeking weapons, hellbores, PPDs, maulers, which do not use NVC) will be resolved on the above charts. While contemporary students of starship combat may be puzzled by this, consider that it would be illogical for a race to adopt a doctrine that their weapons could not use or to carry weapons their doctrine would not allow them to fire.

Mines (including transporter bombs) do not use NVC.

**(D6.44) BRIDGE:** Systems that are destroyed on "Flag Bridge" hits would be hit on "12" on chart (D6.411) instead of a bridge.

**(D6.45) RACES USING:** There is no recorded instance of a Romulan captain using non-violent combat. Except for the Federation and Pirates, other races use it only rarely. (Players may, of course, use it if they wish regardless of the race they are playing.)

**(D6.46) MARINES:** Boarding party actions by a ship using NVC require the use of "stun" weapons. Obviously, the non-violent troops could be on both sides or either side.

**(D6.461) "Destroyed" enemy boarding parties and control boxes return to action at the start of the Turn #3 after they are eliminated. (If a boarding party is destroyed during the combat portion of Turn #4, it returns to duty at the start of Turn #7.)**

**(D6.462)** When a ship is captured (or the attempt fails with all enemy boarding parties stunned), all "stunned" boarding parties are presumed to be captured by the victorious (but non-violent) troops.

**(D6.463)** If using (D16.12), stunned boarding parties are captured when the area they are in is captured.

**(D6.464)** Orions may use NVC in ship-to-ship combat and standard (i.e., violent) boarding party actions when trying to capture cargo ships. In such cases, any race could do the same, but the Orions are more likely to face such a situation. This decision must be made before the scenario begins and cannot be changed during the scenario.

**(D6.47) ALLIES:** When ships of two races are allied and only one is using NVC, each functions accordingly. In the case of NVC with boarding parties, where boarding parties of the two allies were fighting those of a third race, have each of the allies attack and score casualties separately. Any odd casualties are scored as stunned.

**NOTE:** There has been a great deal of philosophical discussion regarding this rule. Wargamers who bought this game because it was a good tactical space combat game may feel that the use of rule (D6.4) limits their activities and spoils the fun. Science fiction fans who bought this game so that they could live the adventures they had been reading will enjoy the challenge of the rule. It may well be argued that this doctrine was never used on film, or at least that there is not conclusive evidence that it was. Purists may claim that the doctrine is built into the battle computers and used automatically. It has been established that the only direct references to it are in material published long after the film. It should be noted that this rule can be used effectively by pirates who wish to capture a ship without damaging the cargo, by captains rescuing hostages, and by ships attempting to keep combat situations to a minimum.

**(D6.5) UBITRON INTERFACE MODULES (Commanders)**

The Klingon Deep Space Fleet has experimented with this device as a means of achieving more effective long-range firepower from their ships. It is basically a passive amplifier designed to increase the effectiveness of disruptors by more accurate fire control. Due to the vagaries of its operation, however, it is useful only at certain ranges. The UIM is used *only* with disruptors, not with any other weapon.

**(D6.51) DISRUPTORS:** When using the UIM system, normal disruptors firing at effective ranges of 16 to 22 are resolved as if they were fired at a range of 15. Most versions of the disruptor chart have a UIM line showing its effects. See (D6.55) for overloads.

The UIM affects only the hit probability of, not the damage caused by, the disruptor.

UIMs cannot be used without active fire control (D6.623) and a lock-on to their targets (D6.124).

**(D6.52) BREAKDOWN:** Whenever the device is used for fire control, there is a 33% chance that it will break down (the special liquid crystals burn out easily).

**(D6.521)** Roll a die at the end of any (and every) impulse in which the device is used. A "1" or "2" will result in breakdown. This die roll is not secret.

**(D6.522)** UIMs cannot be repaired during a scenario. They can be repaired between scenarios using the campaign repair system (D9.4); assume a UIM to be equal to one weapon for this purpose.

**(D6.53) DISCRETIONARY USE:** Players are not required to use a UIM on every impulse that they fire disruptors or for every disruptor they fire during an impulse. Use of the UIM is entirely at the discretion of the owning player.

**(D6.54) EFFECT OF BURNOUT:** When a UIM breaks down, all disruptors which were fired under its control on that impulse are temporarily affected, but eventually return to normal operation.

**(D6.541)** The disruptors controlled by a given UIM may not fire for 32 impulses after the impulse on which the device burns out. Thereafter, resume normal operations.

**(D6.542)** A ship could have up to three extra UIM systems as standby systems. These are already "installed," no special procedures are required. A backup module cannot be used for 1/4 turn after the failure of a UIM, but disruptors not affected by (D6.541) can be fired without UIM control in such cases.

**(D6.55) OVERLOADS:** The UIM may be used with overloaded weapons; the limitations of (D6.51) apply. A ship firing overloaded disruptor bolts (even with the aid of a UIM) cannot fire at ranges greater than 8 hexes. The probability of a hit at effective ranges 3-8 is the same as that at ranges 1-2. (The damage caused is not changed; use the true range.) The UIM cannot be used at these ranges with standard-loaded disruptors. The disruptor table on ships equipped with UIMs has a special line for overloaded-UIM firings.

**(D6.56) INSTALLATION:** The following ships have the UIM as standard equipment:

**KLINGON:** Starbase (one per module), battle station (one standard), ground-based disruptors (available for purchase), monitor (one standard). Backups available for purchase under (S3.2). Many Klingon warships had UIMs standard (or as optional equipment); see ship descriptions. See (R3.R3); available Y165 and later.

**LYRAN:** Starbase (one per module), battle station (one standard), ground-based disruptors (available for purchase), monitor (one standard). Backups available for purchase under (S3.2). Many Lyran warships had UIMs standard (or as optional equipment); see ship descriptions. See (R11.R4); available Y166 and later. Also see (R14.R3) for availability to the LDR in Y170.

**OTHER:** Other units as defined in their specific rules. Some units are specifically listed as having backup UIM systems. The cost of UIMs is shown on Annex #6; this cost is per UIM regardless of the number of disruptors on the ship. UIMs were expensive and, because of this, only larger ships received them. UIMs cannot be purchased as cargo and then plugged in as replacements during a battle.

The UIM became available (to the Klingons) about Y165 but was not widely used until several years later. Other than the Lyrans and LDR, other disruptor-using races never adopted the UIM, finding it too unreliable.

**HISTORICAL NOTE:** In Y170, Federation agents induced a mutiny on the Klingon D6 battlecruiser *Destruction*, resulting in its temporary capture. The Federation examined the UIM system (and the DERFACS system) at some length but apparently did not learn enough to reproduce it or to adapt it to Federation weapons. Ardak Kumerian, captain of *Destruction*, spent his next tour in command of the *Insufferable* (a penal frigate).

## (D6.6) ACTIVE FIRE CONTROL

Ships (including bases, PFs, and interceptors) continuously use their sensors to analyze the surrounding area and locate various items of use or interest, including potential threats and targets. This system is generally referred to as "fire control" but is used for much more than simply firing weapons.

Non-ship units (e.g., fighters) use the same active fire control systems, but as they do not allocate power, the procedures are greatly simplified.

**(D6.61) MODES:** The fire control system can be in "active" or in "passive" mode. Passive fire control is formally covered in (D19.0); active fire control is covered in this section. In active mode, the fire control system transmits signals that reflect from nearby objects and uses high intensity analysis to gain information about those objects. In passive mode, the fire control system transmits nothing; it analyzes energy signals emitted by surrounding objects or reflected from the energy background using the scanners only.

**(D6.611)** Active mode is the only way to achieve a "lock-on," in which the sensors are actively tracking the target and generating fire-control data. The active mode is more accurate (and many systems cannot function with only the passive mode), but also makes the ship easier to see and target. Active mode generates a lock-on (although the lock-on could be prevented by cloaks, terrain, or other factors) while passive fire control can never have a lock-on.

**(D6.612)** Passive mode (D19.0) is used by ships trying to make themselves less noticeable (e.g., those using cloaks or wild weasels, or those hiding in asteroid fields or atmospheres.). It is also used by ships which are required to discontinue active mode. Rule (D19.0) is in Advanced Missions. If you do not have that product, units without active fire control cannot fire at all. See (D6.66).

**(D6.613)** Self-guiding seeking weapons generate and obtain their own lock-ons; they do not have a passive mode.

**(D6.614)** Inactive mode is a term applied to ships without active fire control but which are prohibited from firing under PFC (D19.0).

**(D6.62) RESTRICTIONS ON PASSIVE (or INACTIVE) MODE:** If the fire control system is not in active mode, the ship is under certain restrictions.

**(D6.621)** The ship cannot fire weapons or launch/guide seeking weapons except as may be allowed in (D19.0).

**(D6.622)** The ship can use ECM but not ECCM.

**(D6.623)** If the fire control system is not in active mode, the ship cannot use any of the following systems except as may be specified by (D19.0): Aegis Fire Control (D13.0), Anti-drones (E5.14), DERFACS (E3.62), Displacement Devices (G18.13), Maulers (E8.15), PPDs (E11.15), Special Sensors (G24.161), Stasis Field Generators (G16.35), Tractor beams (G7.412), Transporters (G8.17) [Exception (G13.421)], UIMs (D6.5), Web Casters (E12.13), or Web Snares (E13.1). See also Annex #7P.

**(D6.624)** An existing tractor link can be continued without active fire control. Transporters can be used for evacuation under (D21.0) without AFC.

**(D6.625)** An ESG could be activated in passive mode, although this would expose the position of the ship and nullify the benefits of (D19.0).

**(D6.626)** Bases under passive fire control cannot control mines (M5.27). (Non-base units, with the exception of sensor mines, can never control mines.)

**(D6.627)** Scouts cannot lend EW (G24.218) without a lock-on [exception (G24.28)] and can only have a lock-on if their fire control is active. The lock-ons held with tractors (G7.97) are adequate for direct-fire weapons but not for EW lending.

**(D6.628)** A ship without active fire control adds one to the die roll for terrain effects including (P2.223), (P2.231), and (P3.2). This modifier is cumulative with others such as nimbleness and legendary officers.

**(D6.63) CHANGING MODES:** Fire control can be changed from the active to passive (or inactive) mode (and vice versa) during any impulse in the Initial Stage (6B1). Involuntary mode changes to passive mode (cloak, WW) are made at the instant of the action requiring the mode change.

**(D6.631) ENERGY:** Using active fire control requires one point of power (B3.1 line 8). This point of power is necessary and sufficient for the entire turn or any part thereof, even if the ship switches to passive

mode during the turn and then back to active mode during the same turn. The ship receives no "credit" for the time when fire control was in passive mode and cannot use part of a point of power for part of a turn of active fire control. "Unused" fire control energy does not carry over to the next turn. PFCs, shuttles (including fighters), captor mines, small and medium ground bases, self-guiding seeking weapons, and certain other units noted in the rules do not allocate energy for active fire control. Note the exception to the cost in (D6.7).

**(D6.632) GOING PASSIVE:** A ship can switch its fire control system to passive (or inactive) mode immediately. This can be done during the lock-on step of any impulse. The player must announce this fact. This change will be required by certain actions (e.g., cloak activation, WW launch).

**(D6.633) GOING ACTIVE:** A unit is assumed to be using active fire control from the start of the scenario unless and until the owning player (or the scenario rules) says it is not. When switching to active fire control, the point of power required may have been allocated at the start of the turn or may be reserve power used at the time of the announcement. Reactivation requires four impulses (1/8 turn); the unit cannot use active fire control until this period has elapsed from the declaration that fire control is being activated. (For example, the player announces during the lock-on step of Impulse #4 that he is activating his fire control system. The system is considered to become fully functional at the start of the lock-on step of Impulse #8.) The benefits of PFC [e.g., (D19.31)] are, however, lost immediately upon activation (four impulses before it becomes functional). If the system is in passive mode during one turn and placed in active mode on the next turn, it will still require the four impulse activation period. Activation can be cancelled during the four-impulse period, but the unit will have already lost any PFC benefits.

**(D6.64) EFFECT ON CLOAKS:** When a ship (so equipped) activates its cloaking device, it must immediately place the fire control system in the inactive mode (G13.131). Note in (D19.21) that the passive mode will not be fully functional when the ship is cloaked. The fire control system is in inactive mode during the fade-out period and while the ship is cloaked. Switching the system to active mode will void the cloaking device; however, there is no effect if the system is activated at the same point where the cloak is deactivated. In this case, the four impulses required to reactivate the system will largely coincide with the fade-in period; the system will not be active until the four impulse activation period *and* fade-in are complete. As a practical matter, it is impossible to activate the fire control system without deactivating the cloaking device.

**NOTE:** Cloaked ships activate their fire control scanners when beginning fade-in and deactivate them when beginning fade out. There is no additional penalty in this rule for cloaked ships; this rule in fact explains why cloaked ships operate as they do. A cloaking ship cannot use passive fire control to fire, launch, or guide weapons during the fade-in/out period. The cloak restrictions supersede the PFC restrictions.

**(D6.65) EFFECT ON WILD WEASELS:** When a ship launches a wild weasel, it must immediately place the fire control system in passive mode. Note that firing weapons or taking certain other actions, even though allowed by the passive fire control mode, will void the wild weasel immediately. Switching the fire control system to active mode will void the wild weasel immediately, except during the "explosion period;" see (J3.2112). Outside of the explosion period, activating the fire control immediately voids a WW (at the start, not the end, of the four impulse activation period). A ship on passive fire control can receive ECM from lending or a WW. See also (G13.54) regarding use of a WW by a cloaked ship.

**(D6.66) EFFECT OF SENSOR RATINGS:** A ship with a sensor rating of less than six allocates power for fire control (during energy allocation or with reserve power) and then rolls a die. If the die roll is greater than the sensor rating, the fire control system does not function in active mode during the turn (the energy is lost); it can function in passive mode. A new die roll is made at the start of the next turn (if another point of power is allocated), and if successful the system becomes active immediately (without the four impulse delay). This explains, rather than modifies, the existing rules that such ships cannot gain a "general" lock-on.

**(D6.67) EFFECT ON X-SHIPS:** See (XD6.633).

**(D6.68) DISRUPTED FIRE CONTROL:** Ships can have their fire control disrupted by a variety of means, including: stasis (G16.73), displacement (G18.42) & (G18.53), computer failure (G11.411), and ship separation (G12.52). Some of these rules may provide additional penalties or exceptions to the penalties here. This also applies to fighters and shuttles. Also see (G2.23). The disrupted fire control lasts from the point at which the disruption occurs to the same point in the Sequence of Play four impulses later, e.g., if displaced (G18.0) in step 6D5 of Impulse #5 the disruption ends in step 6D5 of Impulse #9.

A ship with disrupted fire control is under the following restrictions for 1/8 turn (4 impulses) at which point fire control returns to normal.

**(D6.681)** Fire control is treated as "inactive." This is an involuntary change under (D6.63). This prevents the use of tractor beams, transporters, and various other systems that depend on a lock-on for use; see (D6.62). The fire control is still in the original mode (unless the player voluntarily changes it) but simply isn't functioning. (It is trying to re-establish its normal target tracking.) There is a partial exception in (G2.24).

**(D6.682)** The ship cannot fire any weapons, even under passive fire control, or control seeking weapons. EXCEPTION: The ship may fire direct-fire weapons at any seeking weapons within three hexes of itself (regardless of the facing or status of the weapon) just as if its fire control was not disrupted. (The valiantly struggling fire control computers interpret this type of target as a very definite threat and give priority to establishing target tracks for them.) A shuttle identified as a seeking weapon can be fired at; a shuttle not so identified cannot be fired at in this case.

**(D6.683)** Units with disrupted fire control cannot lay mines by any means (e.g., transporters, hatches).

### (D6.7) LOW-POWER FIRE CONTROL

When the ship does not need full combat capabilities, but does need to fire some weapons, it can use its fire control system on low power settings. This system is often used by freighters and other non-warships.

**(D6.71) ENERGY COST:** Low-power fire control (LPFC) costs 1/2 energy point per turn (a full point could be allocated and only a half point used until later in the turn).

**(D6.72) LIMITATIONS:** LPFC cannot be used to fire at or guide weapons toward a target more than 15 hexes (effective range) distant. LPFC cannot control more than two direct-fire and two seeking weapons (only one seeking weapon if not armed with drones or plasma torpedoes). LPFC cannot use more than three points of ECCM. LPFC cannot use Aegis, maulers, special sensors, DERFACS, UIM, or NVC. A base using LPFC cannot control mines.

**(D6.73) ACTIVE:** While LPFC uses less power, it is still "active" fire control (e.g., it will void wild weasels and cloaks, etc.). If a ship is using low-power fire control, it cannot increase its rate of fire/launch by using passive fire control with other weapons. A ship cannot operate simultaneously under LPFC and PFC (D19.0), and cannot fire any weapons on PFC while operating LPFC. LPFC can be detected as such at Tactical Intelligence Level B (D17.4). Reserve power (or the other half of a point of allocated power) can increase LPFC to normal active fire control under (D6.633). If a ship switches from LPFC to AFC, it incurs the same delays as switching from passive to active fire control, and is under all the restrictions of activating its fire control as if it were under passive fire control.

### (D7.0) MARINE BOARDING PARTIES (Advanced)

All warships (and some others) are provided with groups of trained troops that can be used in various security duties. These troops can also be organized and used as boarding parties. The number of boarding parties available to each ship type is shown on the MASTER SHIP CHART. The terms "boarding party" and "marine squad" are interchangeable.

**(D7.1) RECORD KEEPING**

**(D7.11) UNITS:** Boarding parties are recorded as individual units. At any time, and for any reason, players (or a player) on one side may transfer boarding parties from one ship to another by (D7.16). In multi-scenario campaign games, the boarding parties are carried over from scenario to scenario, as assigned to the various ships.

**(D7.12) RACES:** Boarding parties of different races are identical for game purposes. The Gorn and Kzinti races are physically larger and more powerful than the other races in the game. This has been compensated for by including more boarding parties on their ships. (While there is no hard-and-fast rule, it could be assumed that a Gorn boarding party had four troops, a Klingon BP five, and a Hydran BP six.) No combat or crew casualty adjustments are necessary in combat between the various races.

**(D7.13) RECORDS:** The records for boarding parties are kept independently from the crew records. However, see (G9.31).

**(D7.14) GROUND TROOPS** being carried (by certain ships) are included in the ship's BPV and can be used as boarding parties.

**(D7.15) OTHER UNITS:** Other rules such as (D15.8) provide other units for use in boarding party combat such as commando teams, heavy weapon squads, civilians, and militia squads. The basic procedure given here in (D7.0) uses only the marine units.

**(D7.16) TRANSPORTATION:** Marines can be moved between ships by shuttle (J2.211), docking (C13.47), or transporter (G8.31)-(G8.32).

**(D7.17) EXTRA MARINES:** Ships may purchase extra boarding parties as Commander's Options (S3.2).

**(D7.18) PENALTIES:** Note that ships with poor crews (G21.141) have various penalties in boarding party combat. Ships with outstanding crews have various advantages shown in (G21.241).

**(D7.2) CAUSES OF BOARDING PARTY CASUALTIES**

**(D7.21) SHIP COMBAT:** Every tenth internal damage point destroys one boarding party (it takes two BPs to make a crew unit), in addition to one crew unit (G9.21). The first four such boarding party casualties are ignored; the last two boarding parties on the ship cannot be killed by this method but could be broken up by the owning player (declared to be simple crew units, it takes two BPs to make a crew unit) to form part of a skeleton crew (G9.41). However, see (D7.51). The BP to be lost is selected by the owning player and can be any of his own BPs (including guards) except one captured by the enemy. Casualties under (D7.832) are scored first, before casualties resulting from general internal damage.

If two or more players (all on different sides) have boarding parties on a ship that is damaged, all take casualties by this procedure. Each of the non-allied races would take casualties at the same rate. All would lose the first BP on the 50th point of internal damage, the second on the 60th point, and so on. The last two boarding parties for each "side" are protected by the first paragraph.

**(D7.22) MARINE COMBAT:** This is man-to-man (or whatever-to-whatever) combat as resolved in (D7.3).

**(D7.23) HIT AND RUN** raids can cause boarding party casualties. See the chart in (D7.81) and rule (D7.832).

**(D7.3) BOARDING PARTY COMBAT**

**(D7.31) COMBAT:** If boarding parties are transported onto an enemy ship, combat occurs between the boarding parties and the ship's defenders. Other rules sections, such as (D15.0), provide for boarding party combat to take place on planets and other locations.

**(D7.32) SEQUENCE:** While boarding parties may be transported onto the ship during any impulse, the actual resolution of combat is

not done until the end of the turn, during the Final Activity Phase; exceptions: (D7.8) and (D7.6).

**(D7.33) IDENTIFICATION:** When combat is taking place, the "defending" player is assumed to be the player owning the starship, and the "attacking" player is the one who boarded it.

**(D7.34) MULTI-SHIP:** More than one ship may transport boarding parties to the ship on which the combat is taking place, and ships friendly to the boarded ship may also send boarding parties to assist in the defense.

**(D7.35) MULTI-SIDED COMBAT:** In the event that three players have boarding parties in one ship (area, ground combat location, or whatever), and no two are allied, the situation is resolved as follows:

Each player divides his boarding parties into three groups, one to fight each of the two opposing players and a non-fighting reserve. (One or two of the three groups could have zero strength.) This is done secretly (in writing) and simultaneously; the distributions are then revealed simultaneously. Three separate actions (A vs B, B vs C, C vs A) are then resolved (simultaneously in game terms). If, for example, player A's force sent to fight player B destroys all of the player B forces sent against him, excess casualties are resolved against player B's reserve at the normal rate and, if they exceed that reserve, against player B's forces sent against player C at double the normal casualty rates (i.e., each casualty point kills two boarding parties). The player A forces sent against player B would not score casualties against player C even if all player B forces were destroyed.

If there are four or more non-allied players in the location, the same principle is involved with fewer troops.

**(D7.36) CONTROL:** Each control room on the ship (bridge, emergency bridge, auxiliary control, security, flag bridge) consists of one or more contiguous SSD boxes. (It is possible to have more than one control room of a given type, particularly on a tug with pods. Each is a separate room.) The capture of all undestroyed control rooms results in the "capture" of the ship; see (D7.50).

**(D7.361)** In Step 4 of the combat procedure in (D7.4), the defending player has the option of giving up one or more undestroyed control rooms instead of giving up boarding party casualties.

**(D7.362)** Each control room with one or more undestroyed boxes counts as two casualty points regardless of the number of undestroyed boxes in it (three points for a security station). These control rooms are captured, not destroyed. While one casualty point can be scored on a given control room (having no real effect), no more than one control room can have this damage applied at any given time. Any subsequent control room casualties, whether by voluntary or directed damage, must be scored on the same room until it is captured.

**(D7.363)** Once the attacking player has captured one or more control rooms, he may give them up instead of losing casualties in the same manner.

**(D7.364)** Control rooms have no offensive potential in boarding party combat. Security stations (D7.4-Step 2A) have an effect on boarding party combat.

**(D7.4) COMBAT PROCEDURE**

**(D7.41) STEP 1:** Each player determines his total combat power.

For the attacking player, this is the number of boarding parties which he has on the enemy ship. For the defending player, this is the number of boarding parties on the ship under attack.

Control stations do not count as they have no offensive potential. The advanced rules in (D15.8) provide for various other types of boarding party combat units, such as militia (D15.83), that could be used.

**(D7.42) STEP 2:** Each player rolls a single die and cross-indexes the result with the total number of boarding parties he has to reveal the number of casualty points scored on the other player's forces. If a player has more than 10 boarding parties, he divides these into one or more groups of 10 and (usually) a single group of less than 10. For example, 23 boarding parties would be resolved as two groups of 10 and one group of 3. Roll a separate die for each group.

**(D7.421) MARINE CASUALTY RESOLUTION TABLE**

DIE ROLL	Number of Boarding Parties									
	1	2	3	4	5	6	7	8	9	10
1	0	0	0	0	1	1	1	1	1	1
2	0	0	1	1	1	1	1	2	2	2
3	0	1	1	1	2	2	2	2	3	3
4	0	1	1	2	2	2	3	3	4	4
5	1	1	2	2	3	3	4	4	5	5
6	1	1	2	2	3	4	4	5	5	6

**(D7.422) STEP 2A:** Klingon marines on Klingon ships add one to the die roll for each undestroyed and uncaptured security station (not box) on the ship. The maximum adjustment is +2, even if there are more than two security stations. An adjusted die roll of more than 6 is treated as a 6. In cases where boarding parties of various crew quality levels [i.e., (G21.141) and (G21.241)] are on one "side," resolve casualties caused by each force separately, then add the total.

**(D7.43) STEP 3:** Each player has the option of using some of the casualty points scored by his troops for "specific allocation," which means that he can choose what those points are used for. In this case, however, it requires two casualty points to destroy each boarding party and four to capture a control room (six for a security station).

**(D7.44) STEP 4:** Each player removes a number of boarding parties equal to the casualties produced by the other remaining after Step 3. See (D7.36) for the option to give up control rooms instead of boarding parties.

**(D7.45) EXAMPLE:** A Klingon D6 battlecruiser has been seriously damaged by Turn #5 of the game. It only has three command boxes (one auxiliary control, one emergency bridge, one security) and four boarding parties left. Three Federation ships are in the area and transport a total of nine boarding parties onto the Klingon ship. Combat is resolved at the end of Turn #5 as follows:

The Klingon player rolls a "4" which is adjusted to a "5" by the one surviving security station. Cross-indexed on the chart this produces two casualty points, meaning that the Federation player will have to give up two of his marine squads. (There is no need for the Klingons to use the option in Step 3 as the Feds have only one type of unit to lose.) The Federation player rolls a "2" which causes two casualty points. The Federation player passes on the Step 3 option; the Klingon player gives up the auxiliary control room to resolve two of the casualty points.

During Turn #6, the three Federation ships send 13 boarding parties onto the ship. Of these, however, 10 are sent at the higher non-combat rate the impulse after the first three (G8.32) and cannot be used offensively. The other three combine with the seven survivors from the original wave to form a single group of 10 squads. The Klingons still have 4 boarding parties. At the end of Turn #6, the Federation rolls a "4" meaning he has scored four casualty points. The Klingons roll a "2" which is adjusted to a "3" by the security station, scoring only 1 casualty. The Federation player uses the Step 3 options to insist that the four casualty points be resolved by destroying two Klingon boarding parties; otherwise the Klingons could give up another control room. (This is a mistake on the Federation player's part since there are so few Klingon forces. If he had skipped step 3, the Klingons would have had to give up one control room and some of their remaining troops, or ALL of their remaining troops.) The Federation player gives up one Marine unit. The battle continues.

**(D7.46)** Boarding parties cannot destroy boxes on a unit unless that unit has been captured (D7.5). Exception: (D16.54).

**(D7.5) CAPTURING A SHIP WITH BOARDING PARTIES**

**(D7.50) HOW TO CAPTURE:** A starship is considered to be captured if all undestroyed control rooms (including security stations) have been captured. When a starship is captured, the capturing player cannot operate the weapons of the ship, but can maneuver it and attempt to leave the map with it.

**(D7.501)** If there are no undestroyed control rooms, the defending player may designate one of the destroyed control rooms (not a security station) as operational ("temporary control room"). This temporary control room is providing the limited control capabilities noted in (G2.2); it is where the highest-ranking officers have gathered to attempt to restore control. When this temporary control room is surrendered to or captured by the attacking player, the ship is captured even though combat may continue. See (D7.52).

**(D7.502)** If a ship disengages with an ongoing boarding action still in effect, the scenario is extended aboard that ship until the boarding action is resolved.

**(D7.51) CREW:** For a captured ship to be moved, it must be manned by a "skeleton crew." See (G9.41) for required size. This crew must be transported from the capturing player's other units. Boarding parties cannot be reformed into crew units (G9.432) on a captured ship, but militia can be.

**(D7.511)** There must be one boarding party for every 10 enemy crew units on board (to guard the prisoners). If the required guards are not provided, any excess unguarded enemy crew units can be formed into militia as per (D15.83). Prisoners cannot be executed; life support must be maintained. Unguarded crew units may voluntarily destroy one system box for every four crew units that are unguarded.

**(D7.512)** Until the skeleton crew arrives, the ship cannot move or operate any systems, except that life support will continue and the shields will remain at the same operating status as they were immediately prior to the capture (assuming power is available). No shield reinforcement can function without the skeleton crew. During Energy Allocation, continue the previous power to the shields (except reinforcement), allocate power to life support, to fire control (if it was operating immediately prior to capture), allocate power to recharge any batteries, and then leave the remainder of the power unallocated.

**(D7.52) CONTROL SYSTEMS:** If all control boxes had been destroyed, the capturing player can designate one of the "destroyed" control rooms as his temporary control room under (D7.501). This need not be the same temporary control room previously used by the defenders.

**(D7.53) ACTIONS ON CAPTURE:** When captured, a ship immediately takes the following actions.

**(D7.531)** The ship drops or releases control of all seeking weapons (F3.4); it cannot transfer this control to an allied ship.

**(D7.532)** The ship ceases to operate ESGs, PPDs, and SFGs.

**(D7.533)** The ship ceases to use erratic maneuvering.

**(D7.534)** The ship ceases to perform repairs or to reload fighters/PFs. All shuttles and PFs on board are captured (J1.81).

**(D7.535)** The ship ceases to operate EW or scout systems or lend EW to its fighters or PFs.

**(D7.536)** The ship ceases to be affected by crew or officer quality of the original crew.

**(D7.537)** The ship no longer "leads" formerly friendly units through asteroids. The arming of multi-turn weapons ceases; the energy is lost and the weapon ejected. Any WW, SP, or SS shuttles in the bay or on the balcony become inactive.

**(D7.538)** Other effects are as per the rules. A captured Tholian ship loses the ability to move and fire through webs or function as an anchor. A captured base loses the ability to control command-detonated mines. If a base is captured the capturing player will learn the location of all command-detonated mines after the current scenario and before the next one.

**(D7.539)** The capturing player may destroy one box on the SSD of the captured unit for every five boarding parties or crew units that are not involved in guarding prisoners or operating the ship (D7.51).

**(D7.54) OPERABLE SYSTEMS:** The capturing player can operate the following systems only: engines, control spaces, APR, batteries, cloaks, labs (scientific research only), transporters (not T-bombs), shields, ECM, movement (except EM, HET, Emer-Decel, or nimble), tractor beams, pod detachment. To operate these systems requires the skeleton crew in (D7.51). AWR, active fire control (needed for various non-weapon systems), and shields can be used. The capturing player cannot deactivate life support if this would result in casualties among the original crew on board. The capturing player begins controlling the ship on the Energy Allocation Phase that is at least 32 impulses from the point at which he has met the conditions of (D7.51) for a skeleton crew.

**(D7.541)** The capturing player can operate his own shuttles that transfer to the captured ship but only as administrative shuttles, not as scatter pack, suicide, or WW shuttles. The shuttles (not fighters) of the captured ship can be operated (or charged and used as WWs), but their weapons cannot be used and they cannot be used as scatter-pack or suicide shuttles.

**(D7.542)** The captured ship has an assumed damage control rating of 2 for purposes of (D9.7) continuous repairs. Within a given scenario (and some campaigns where the limit applies over several scenarios), each side can perform the limit of repairs under (D9.7), but does not get a new limit if a captured ship is recaptured.

**(D7.55) INOPERABLE SYSTEMS:** The capturing player cannot operate the following systems: weapons (any weapon listed in any part of Annex #7D), fighters, PFs, mines, ECCM, scout channels, super-intelligent computer, self-destruct, displacement device, certain movement functions (e.g., EM, HET, quick reverse, emer-decel, nimble), and the ability to control seeking weapons. These items can be used on a captured ship in a subsequent scenario. Any fighter pilots or PF crews would be Green [(J6.22) and (K8.22)]. Exception (D7.541).

**(D7.551)** The capturing player cannot use aegis or labs to identify drones and cannot separate sections, drop warp engines, double Orion engines, or use non-galactic (Andromedan and Tholian) abilities or equipment. These items (except for extra-galactic technology) can be used on a captured ship in a subsequent scenario.

**(D7.552)** PA panels will remain operating at the current level and will absorb and dissipate damage to the limit of their ability, but power cannot be transferred to, from, or between panels (or to the batteries) and the level cannot be increased. This is an automatic system which the panels default to when the crew is no longer functional. The capturing crew could turn the panels off or reduce their level after the skeleton crew is aboard and control established, but could not subsequently raise their level or turn them back on.

**(D7.553)** The special abilities of security stations apply only to the original owner of the ship. Andromedan, Tholian, or Seltorian specific technology is lost and cannot be reactivated. Other systems, such as Aegis, can be restored as part of the conversion process.

**(D7.554)** A captured ship may be released from some or all of these restrictions after the scenario is over and the ship is taken to a shipyard for overhaul and conversion.

**(D7.555)** A legendary weapons officer (G22.75) can unlock the weapons on a captured ship.

**(D7.56) CONTINUING COMBAT:** It is possible (either by using the Step 3 options or because the defender allowed it to happen) that a ship could be captured while some of its defending boarding parties are still active. Alternatively, boarding parties friendly to the original owners could be transported aboard. In this case, boarding party combat continues and the original owner might even recapture the ship. If he does so, he is treated as the original owner (which he is), not as a capturing player.

**(D7.57) CAPTURED AND CONVERTED SHIPS:** For campaign purposes, ships captured and overhauled/converted such as the D7H *Anarchist*, most of the WYN fleet, or OK6 *Conquest* count as belonging to the capturing race, not the original race. In this case, it is the capturing player who has full (D9.7) capabilities and the recapturing player who has the assumed damage control rating of 2.

**(D7.6) CAPTURING SHUTTLECRAFT WITH BOARDING PARTIES (Commander's Level)**

**(D7.60) PROCEDURE:** Players may attempt to capture manned shuttlecraft with boarding parties. If the shuttle has a BP aboard, then see (D7.836) and (D7.831). Fighters may not be boarded (J4.42); exception (D7.631).

**(D7.601)** One boarding party (only) may transport onto an enemy shuttlecraft. At the instant this party arrives, a die is rolled:

NORMAL	CMDO	OUTST	POOR	RESULT
1-2	1-3	1-3	1	Shuttle Captured
3-5	4	4-5	2-4	BP Destroyed
6	5-6	6	5-6	Issue In Doubt

**(D7.602)** A die roll of "6" indicates that the issue is still in doubt. The shuttle stops moving at that point, and combat is resolved again at the end of the turn. If still in doubt, the shuttle does not move and a die is rolled to resolve combat at the end of each turn until resolved. If the "issue is in doubt" the shuttle cannot move or fire any weapons. It can drop chaff, but it cannot lay mines or control seeking weapons. It cannot take any other action unless specifically permitted by a rule.

**(D7.603)** A player may not operate the weapons of a captured shuttlecraft.

**(D7.604)** Upon arrival, the BP will be told if the shuttle is manned or seeking. If a seeking shuttle, proceed under (D7.62) not (D7.60).

**(D7.61) WILD WEASEL SHUTTLES:** Boarding parties may attempt to board and capture WW shuttles. Roll a die when the BP arrives.

**(D7.611)** Voided Captured: WW systems are deactivated, WW voided (J3.4), weapons tracking WW return to original target, and the BP takes over the shuttle.

**(D7.612)** Exploded: WW and BP destroyed; explosion period (J3.211) begins.

**(D7.613)** Issue In Doubt: Roll again at end of each turn until resolved. WW continues normal operations.

NORMAL	CMDO	OUTST	POOR	RESULT
1	1-2	1-2	1	Voided-Captured
2-4	3-4	3-4	2-3	Issue in Doubt
5-6	5-6	5-6	4-6	Exploded

**(D7.62) SEEKING SHUTTLES:** Boarding parties may attempt to board and capture seeking shuttles; roll a die when the BP arrives.

**(D7.621)** Deactivated Captured: Suicide or SP systems deactivated (J1.86), BP takes over the shuttle.

**(D7.622)** Booby Traps in the shuttle have destroyed the boarding party. The shuttle continues on its mission. These booby traps can be voluntarily deactivated by the owning player prior to launch.

**(D7.623)** Issue In Doubt: Roll again at the end of each turn until resolved. The seeking shuttle continues its mission.

NORMAL	CMDO	OUTST	POOR	RESULT
1	1-3	1-3	1	Deactivated-Captured
2-5	4-5	4-5	2-4	Issue in Doubt
6	6	6	5-6	Booby Trap

**(D7.63) SHUTTLE BAY:** Combat involving enemy shuttles inside the ship's shuttle bay (G7.8) or (J1.63) is resolved as follows:

**(D7.631)** At the end of each turn that any uncaptured enemy shuttle is in the shuttle bay, boarding parties belonging to the ship can attempt to capture it. One or two boarding parties can make the attempt against any one shuttle, and each can attack only one shuttle. The target of each BP is announced before any attacks are resolved. These boarding parties can have participated in no other actions (other than guarding that shuttle bay; guards can be released for this purpose) on that turn and can make only one attempt each. Roll one die for each attempt and interpret the result as follows:

DIE ROLL	FIGHTER, HEAVY FIGHTER	ADMIN, MSS, MLS, HTS, OTHER	MRS, GAS, SWAC
1	Captured	Captured	Captured
2	Captured	Captured	Captured
3	Captured	Captured	Captured
4	Captured	Captured	No Effect
5	Captured	No Effect	BP Killed
6	BP Killed	BP Killed	BP Killed

**(D7.632)** If the shuttle has been crippled (J1.33), it cannot resist any attempt to capture it with boarding parties. See (D7.6332) for a special case.

**(D7.633)** If there are boarding parties on board the shuttle (friendly to the shuttle, not the ship), they can remain on board the shuttle or disembark.

**(D7.6331)** If the boarding parties leave the shuttle, their fate and that of the shuttle are resolved separately, in accordance with the appropriate rules. The shuttle cannot fire in support of the

marines as it could on the ground (D15.0); it can fire as per (G7.81). Note that if they were loaded at the non-combat rate (J2.211), they could not fight offensively on the current turn.

**(D7.632)** If these boarding parties do not board the enemy ship, then modify the die roll (D7.631) against their shuttle by +1 and treat a crippled shuttle (D7.632) as an uncrippled one except that the shuttle itself cannot fire. If there is more than one BP on the shuttle, only one can fight to defend the shuttle.

**(D7.634)** It is presumed that the shuttle landed during "recover shuttles" and that any boarding parties disembarked from the shuttle during "operate transporters" of any later impulse at the owning player's option. The boarding party could return to their shuttle during the "operate transporters" of any later impulse. The shuttle cannot launch during any impulse in which it has taken boarding parties on board. The shuttle cannot launch within 1/4 turn of landing as in (J1.52) and, under some circumstances, may not be able to launch at all. Boarding parties delivered by this procedure cannot be used for hit-and-run raids. Shuttles which have (voluntarily or otherwise) landed in an enemy bay *always* turn off their warp booster packs (if any).

**(D7.635)** A legendary marine major (G22.5) counts as a boarding party, even if he arrived in the back seat of a two-seat fighter (J4.43).

**(D7.636)** Outstanding or commando BPs get a -1 on the die roll in (D7.631) to attack a shuttle; poor crews and militia have a +1. A die roll of 6 is never modified and always remains a 6.

**(D7.637)** Boarding parties on the ship could attempt to attack (rather than capture) the shuttle by firing at it with low-powered weapons. Such an attack is made in the Final Activity Segment instead of the attempt to capture the shuttle. Up to four boarding parties may fire at the shuttle; each does one point of damage automatically. The obvious intention is to cripple the shuttle; this method is slower but more certain than attempting to capture it outright.

**(D7.7) PREVENTING SELF-DESTRUCTION  
(Commander's Level)**

If boarding parties are on board of any given starship, they may be able to prevent self-destruction from being carried out if the crew should attempt to do so (D5.52).

**(D7.71) PROCEDURE:** In such cases, the owning player (of the ship) must roll a die at the time that self-destruction is announced to determine if the boarding parties have prevented self-destruction. The die roll cannot be made if the ship is not attempting self-destruction.

DIE ROLL	RESULT
1	Self-destruction is permanently blocked.
2-3	Boarding parties temporarily prevent self-destruction. Roll again on the next turn.
4-6	Crew successfully destroys ship.

**(D7.72) ATTACKING MODIFIERS:** Certain special types of boarding parties gain a die roll modifier.

If the only functional enemy boarding parties on board are militia, add one to the die roll.

If one or more of the enemy boarding parties is a commando squad, subtract one.

If there is an enemy Marine Major or enemy Legendary Engineer on board, subtract one from the die roll. This is not cumulative with commandoes (or another such officer), but is used instead of the militia modifier.

**(D7.73) DEFENDING MODIFIERS:** Certain cases can cause a defensive modifier.

If the ship has an outstanding crew, add one to the die roll. If the crew is poor, subtract one.

If there is a legendary marine, engineer, weapons officer, or captain aboard, add one. Multiple officers are not cumulative with each other, but are cumulative with a crew modifier.

**(D7.74) HIT AND RUN** raids cannot deactivate a self-destruction system or interfere with the attempt.

**(D7.8) HIT AND RUN RAIDS (Commander's Level)**

Boarding parties may be used on "hit and run" raids. In this event, the party is attempting to destroy some key item of equipment on the enemy ship or to capture some item or individual.

**(D7.81) PROCEDURE:** For each boarding party making an attempt, designate the specific box on the SSD that they are attacking. A die is then rolled to resolve their attack on the following chart:

NORMAL	CMDO	OUTST	POOR	RESULT
1	1	1-2	-	System destroyed, BP returns
2	2-3	3	1	Both destroyed
3-5	4	4	2-4	BP destroyed, system ok
6	5-6	5-6	5-6	BP returns, system ok

Even if the transporter being used for a hit-and-run raid is destroyed by an enemy hit-and-run raid on the same impulse, a surviving boarding party still returns to its own ship, and is not stranded on the enemy ship.

**(D7.82) RESTRICTIONS AND CONDITIONS:**

**(D7.821)** Any given boarding party may make ONE such raid per turn, assuming transporters are available. Each transporter can support one such raid, performing both the "in" and "out" operation.

**(D7.822)** Hit-and-run raids are conducted and resolved during the Impulse Activity Segment. Note that each raid is conducted and resolved during the Activity Segment of a specific impulse.

**(D7.823)** Boarding parties can attack "sensor" and "scanner" boxes but not damage control or excess damage boxes. Raids cannot be used to cause critical hits. Hit and run raids can only be conducted against the best (top/left) undestroyed box on the sensor or scanner tracks. Guards on those systems cannot be killed by damage to the system.

**(D7.824)** Hit-and-run raids may be made to remove specific individuals or objects from a given ship. This will normally involve items specified by a given scenario. When trying to capture a person or object, the result "System destroyed and BP returned safely" is read "target captured and BP returned safely." The result "System and BP destroyed" is applied as stated.

**(D7.825)** Non-SSD items and special abilities (Aegis, T-bomb storage, increased drone control, etc.) cannot be attacked by hit and run raids unless the rules specifically allow it. See (D7.85) for other restrictions, conditions, and allowances.

**(D7.826)** Crew units, deck crews, boarding parties, shuttles in flight and other such units cannot be attacked by hit-and run raids.

**(D7.827)** Assassinations (of legendary officers or individuals specified in various scenarios, such as an ambassador) can be conducted by hit-and-run raids. The attacking player indicates that he is making an assassination raid on a given SSD box or room where an individual might be located (G22.13). If the raid is successful *and* if *any* individually identified person(s) is present, *that* person is (or those persons are) killed. (Note that such an attempt has little chance of success unless the location of the target is known, but the scenario may specify locations for a special individual, and legendary officers can only function in certain areas.)

**(D7.83) GUARDS:** A player may designate some of his boarding parties to be guarding specific individuals or objects. In this case, a hit and run raid has a lesser chance of success (D7.831) against these targets, but the boarding party assigned as a guard cannot be used in normal boarding party actions.

Assignments of such guards are made at the start of the turn and cannot be changed until the next turn; no more than one boarding party may be assigned to guard a given compartment or object. See (J1.413).

**(D7.831)** If a hit and run raid is conducted against a guarded object, person, or compartment, roll one die and find the result below.

NORMAL	CMDO	OUTST	POOR	RESULT
1-3	1-2	1-2	1-4	BP Destroyed
4-5	3	3-4	5	BP Returns
6	4-6	5-6	6	Conduct Hit-and-Run

**(D7.832)** If the box that a boarding party is guarding is destroyed by any means, there is a 50% chance that the boarding party was destroyed with it. These casualties are in addition to those in (D7.21). If the boarding party survives, it is immediately released to the general pool of boarding parties.

**(D7.833)** No more than one boarding party can be assigned to guard one object, area, or group of people.

**(D7.834)** Guards do not count in the boarding party calculations under (D7.4). They can be ordered by the owning player to leave their posts and participate in combat during the Energy Allocation Phase, but would have to be re-posted under rule (D7.83) before they counted for (D7.831).

Guards do not count as undestroyed boarding parties for (D7.5). When the ship is captured, all guards may be transferred to boarding party status and may attempt to regain control of the ship.

**(D7.835)** The specific box on the SSD to which each guard is assigned, and the specific box being attacked, must be specified. In cases (such as shuttle bays) in which the owner has not specifically recorded which box contains which unit, determine randomly which items are in each box. See (J1.413).

**(D7.836)** It is not possible to place guards on board a scatter-pack, suicide shuttle, or wild weasel. Boarding parties being transported at combat rates on a shuttle count as guards for that shuttle. When enemy troops try to capture the shuttle, the guards provide a +1 die roll modifier for (D7.6).

**(D7.837)** Under some conditions a single boarding party may guard more than one box on the SSD.

**(D7.8371)** A single boarding party, assigned as a guard, is sufficient to protect all connected control boxes of a single type. For example, if there are two connected bridge boxes, one guard covers both. Different types of control boxes (security, flag, aux, emer, bridge) can never be protected by a single guard.

**(D7.8372)** A single boarding party, assigned as a guard, is sufficient to protect all connected warp engine boxes of a single specific engine (i.e., the left engine of a Fed cruiser, the boom warp engine of a Klingon C8, the two warp boxes of a C7 boom, etc). A single boarding party, assigned as a guard, is sufficient to protect all connected impulse engines.

**(D7.8373)** As the enemy can only conduct a hit and run raid against the highest undestroyed box on one of the tracks (sensor or scanner; remember that damage control and excess damage cannot be attacked by hit and run), a single boarding party, assigned as a guard, protects the entire track.

**(D7.8374)** In all other cases, each box on the SSD must be guarded individually. Even adjoining and connected boxes of the same type (e.g., phasers, shuttle bays) are separate for this purpose.

**(D7.8375)** The casualties of (D7.832) are rolled for if any box in the group is destroyed by a hit and run raid, but not in the case of combat damage unless the entire group is destroyed. This does not apply to adjacent boxes covered by (D7.8374). Exception: Guards on sensors and scanners cannot be killed; see (D7.823).

**(D7.838)** Up to six individuals may be specified as being in a given compartment (or room, a designation not specifically translatable into specific systems boxes on the SSD), and one boarding party can guard that one room. For example, several legendary officers could be designated as being in the "bridge" (which probably corresponds to two or more specific boxes on the SSD).

**(D7.84) MULTIPLE RAIDS:** Two or more raids cannot be made by the same player (race, side, team) on a single box [or (D7.837) group] within a period of 1/8 turn. Exception: (J1.413).

**(D7.85) RESTRICTED TARGETS:** Hit and run raids can destroy, but not capture, a cloaking device (G13.161) or a DERFACS or UIM fire control system. These items could be captured using (D16.12) by occupying the entire area (normally that with the bridge) for two full turns (repulsing all attempted entry). See (D7.825).

**(D7.86) REACTION:** After a hit-and-run raid against a specific system, the owner of the defending ship may (but is not required to) assign or transfer guards to that system or other systems of that specific type (including all types of phasers as a single type) immediately after the hit and run step in which the raid was conducted.

## (D8.0) CRITICAL HITS (Optional)

In order to increase the excitement of particularly tense scenarios, players may wish to include the possibility of critical hits.

### (D8.1) PROCEDURE

If 20 or more damage points (including those scored on shields or reinforcement and those that penetrate) are scored against a given shield during any single impulse, that ship must roll two dice to determine if a critical hit has been scored. [Andromedans: See (D24.0).]

Only one such roll is made during any given turn, even if these conditions are met several times during the turn.

### (D8.2) EFFECT

The systems that suffer a critical hit, and the effect of those hits, are as follows:

- 2 = Active fire control (D6.6) fails; ship switches to passive fire control (D19.0) until active system is repaired.
- 3 = Battery failure. All batteries loose all power and cannot be used to hold power until repaired.
- 4 = Transporter failure. Transporters cannot be used until repaired.
- 5 = Power failure in the labs. Labs cannot be used until repaired. Emergency damage repair (D14.0) is impossible; any such repairs in progress are lost.
- 6-8 = No critical hit.
- 9 = Tractor beam breakdown. Tractors cannot be used until repaired. All existing tractor links are released. This could cause docking to be broken. Negative tractor can be used.
- 10 = Shuttle launch controls jammed on one shuttle bay (select by die roll). No shuttles can be launched or recovered (from that bay, including launch tubes) until it is repaired. See (D8.24).
- 11 = Maneuver restricted. Ship cannot exceed speed of 8, no HET or EM, and turn mode increased by one at all speeds.
- 12 = Warp engine controls are damaged, and the ship cannot use warp energy for movement. One-half of the output of the warp engines can be used for other purposes; the other half of the power cannot be used for any purpose until repaired. See (D8.23).

**(D8.21) DESTRUCTION:** Critical hits never destroy any system. They only prevent its use until the critical hit is repaired. Note that repairs to critical hits are resolved separately from repairs to damage.

**(D8.22) EFFECT:** All critical hits take effect immediately.

**(D8.23) WARP:** In the case of a warp engine critical hit, the ship stops moving immediately. If impulse power was allocated to movement, the ship may use it to make one tactical maneuver during the remainder of the turn. The ship's Energy Allocation Form must be adjusted immediately by (D22.0). When resolving power loss by (D22.0), all energy allocated to movement may be cancelled immediately. An Orion could still double his engines, although he would still only be able to move speed one.

**(D8.24) SHUTTLES** could land and launch from a balcony, but could not move back and forth between the balcony and hangar bay. No mines can be dropped from that bay; no drone racks inside the bay could fire. Note that external bays are each a single bay, so that it is possible for a Tholian Black Widow to have nine jammed shuttle bay doors in effect at a single time. Shuttles can still crash aboard (J1.612) a ship with jammed shuttle doors. It is not possible to crash out of such a bay because (J1.635) says that even enemy shuttles launch by the normal rules.



**(D8.3) REPAIR**

**(D8.31) PROCEDURE:** All critical hits are repaired in the same manner, but if more than one is in effect, the owning player may only attempt to repair one of them during the turn. The ship's damage control parties perform this function. The procedure is to roll one die at the end of the turn. If the result 1-4, the hit is repaired; if the result is 5-6, it is not. The first roll to attempt to repair a critical hit can be made immediately at the end of the turn regardless of whether the hit occurred on Impulse #1 or Impulse #32.

Subtract one from the die roll for the second (and two for the third and subsequent) attempt to repair the same occurrence of the same hit. Outstanding (G21.132) and poor (G21.232) crews have a die roll modifier.

**(D8.32) LEGENDARY OFFICERS:** Legendary Engineers and Science Officers can use (G22.41) to make "independent attempts" to repair critical hits, but no two officers can work on the same critical hit. They must be in the box they are repairing, but would become casualties if ship combat damage struck their previous duty station. For a Legendary officer to repair fire control or maneuver critical hits he must be in a control box. Also see (G22.412). The rule about scoring casualties by hits on the previous duty station reflects that the "destroyed" box which the officer is repairing cannot be destroyed again (at least until he has repaired it).

**(D9.0) DAMAGE CONTROL**

Damage control is the ability of a ship to repair combat damage (and other damage) without a base or other support facilities. In game terms, damage control is used to repair the shields during a scenario, to repair key systems during a scenario, to repair other systems between the scenarios of a multi-scenario campaign game, and to repair critical hits. It is assumed that the damage control parties are, during the course of the game, also taking action to seal off any hull areas that rupture and to prevent any fires or electrical overloads from spreading. This is factored into the various charts and tables and can be ignored.

There are several types of repair and damage control available in the game. Repairs under (D9.2) can be used simultaneously with those under (D9.7) or (D14.0) although not on the same box. Repairs under (D9.7) and (D14.0) cannot be made simultaneously, even to different boxes. None of these procedures in (D9.0) can be used simultaneously with those in (G17.0).

ALL repair procedures repair one box at a time. Two points of power in (D9.2) damage repair will repair one shield box, not all of the damage to one entire shield.

**(D9.1) DAMAGE CONTROL CAPABILITY**

**(D9.11) RATING:** The current level of damage control ability is reflected in the damage control rating, which is the highest undestroyed box on the damage control track of the SSD.

**(D9.12) DAMAGE:** The damage control rating itself may be reduced by damage taken during combat. Generally, all damage control functions are based on the rating at the start of the turn. Emergency Damage Repair procedures (D14.11) also destroy boxes on the damage control track.

**(D9.2) REPAIRING SHIELDS IN COMBAT**

**(D9.21) PROCEDURE:** During any turn, energy may be allocated to damage control up to the highest number on the track. For each two units of energy allocated to damage control, the damage scored to one shield box may be erased at the end of the turn. You must specify which shield you are repairing during the Energy Allocation Phase. If the DC rating is reduced during the turn, energy applied at the start still counts for that turn.

**EXAMPLE:** A Federation heavy cruiser puts four points of power into damage repair for shields (the maximum it can due to its damage control rating of 4) and, at the end of the turn in the Repair Stage of the Record Keeping Phase, two shield boxes are repaired.

**(D9.22) PRIOR DAMAGE:** Energy cannot be allocated to undamaged shields in anticipation of damage. Energy allocated to damage control is NOT used to reduce the effects of hits made during the turn but repairs boxes destroyed in prior turns.

**(D9.23) RESERVE POWER:** Reserve power cannot be used for shield damage repairs.

**(D9.3) CRITICAL HITS**

Damage control may be used to repair critical hits. See (D8.3).

**(D9.4) CAMPAIGN REPAIRS**

Between scenarios of the multi-scenario campaign games, the damage control rating of the ship may be used to repair various systems of the ship. (This procedure assumes that the ship can stop at a base or rendezvous with a repair ship between scenarios. In some campaigns where these facilities are unavailable, use of this section is prohibited.) This is done as follows; in the exact order given. In the case of power absorbers, see (D10.544).

**(D9.41) DAMCON:** All hits on the Damage Control Track are erased. (All repairs listed below are based on the ship's full damage control ability.) All shield hits are erased. A number of hits on control systems equal to the damage control rating are erased. All "Hull" hits are erased.

**(D9.42) POWER:** Multiply the damage control rating by three. This is the number of power system (warp engine, impulse engine, battery, and reactor) hits which can be erased.

**(D9.43) WEAPONS:** Multiply the damage control rating by two. This is the number of weapon system hits which can be erased. For definition of "weapon," see Annex #7D.

**(D9.44) OTHER:** Multiply the damage control rating by three. This is the number of non-weapon, non-control, non-power system hits that can be erased. Excess damage, sensor, and scanner, are treated as non-power/weapon/control hits for this rule.

**(D9.441)** The (D9.7) and (D14.0) repair capabilities are recycled, i.e., the repairs during the scenario are completed by this procedure before using (D9.4) at no cost and the full allowance is available for the next scenario.

**(D9.442)** Any hasty repairs are treated as in (G17.54). If repaired by this procedure, they count as a full repair. If not repaired by this procedure, they remain at their reduced status.

**(D9.443)** All damaged shuttles are repaired between scenarios of a campaign and do not count against other repair limits or capabilities.

**(D9.45) SPECIAL:** Cloaking devices and UIMs destroyed during the previous scenario are replaced if the ship has access to a repair facility (repair freighter, mobile base or larger base). Each counts as one weapon repaired. See (D6.522) and (G13.164).

**(D9.46) SUPPLIES:** See (U1.0) for additional rules on resupply between scenarios of a campaign game.

**(D9.47) NO REPAIR FACILITY:** If no repair facility is available, the ship can use the remainder of its (D9.7) and (D14.0) allowance between scenarios but cannot make the other repairs listed in this section. See also (G17.13).

**(D9.5) LIMITATIONS**

No damage control procedure can ever be used to increase the number of shields or other systems above the number originally shown on the SSD for that ship. That is, damage control can only repair systems; it cannot build new ones.

**(D9.6) CARRYOVER**

Any damaged systems that damage control does not repair after one scenario may be repaired after later ones. A system does not have to be repaired in the interlude immediately following the scenario in which it was damaged, but remains inoperable until repairs are made.

**(D9.7) CONTINUOUS DAMAGE REPAIR**

**(D9.71) PROCEDURE:** All ships (including bases and PFs) have a limited capability to repair damaged systems during a scenario. This system allows a ship in combat to repair one or two critically needed systems as the battle proceeds. This repair is within the limits of (G17.33).

**(D9.711)** Each ship generates (without any cost) a number of repair points equal to its damage control rating on each turn. These points can be used to repair destroyed equipment. The cost of repairing a destroyed system is shown on the Cost of Repair Chart in Annex #9.

**(D9.712)** This rule (D9.7) can be used to repair shields. While this makes shield repair faster, note that (D9.74) limits the use of (D9.7) and the player must seriously consider where these repairs can most effectively be used. This rule can be used along with (D9.2) although not on the same specific box.

**(D9.713)** The attention of desperate players is directed to Hasty Repairs (G17.5).

**(D9.72) POINTS:** The points are "earned" at the start of the turn (equal to the damage control rating at that point) in the Energy Allocation Phase. They must be allocated to repair specific systems at that point. If no systems have been destroyed, no points can be accumulated. Because (G17.33) only allows five repair points to be allocated to a given system box on one turn, and since (D9.74) limits repairs to one system box at a time, a ship may not be able to use as many repair points as it can generate.

**(D9.73) EFFECT:** The system under repair is considered to be repaired at the end of the turn when sufficient repair points were allocated. No system can be repaired on the turn it is destroyed.

**(D9.74) CARRYOVER:** In many (if not most) cases, the ship cannot generate enough repair points to repair a given system box in a single turn. (Most cruisers would generate 4 points, while most heavy weapons cost 8 points or more to repair.) In this case, the ship can accumulate points toward the repair of a given box over a period of several turns.

**(D9.741)** A ship can only accumulate points toward the repair of one system box at time and must complete or abandon the repair of a given system before it can expend points toward the repair of a different system. If the repair of a given system is abandoned, the previously accumulated points are lost but the system can be repaired later.

**(D9.742)** When sufficient points have been accumulated to repair one box, the ship can immediately begin accumulating points to repair another one during the same turn. For example, on Turn #3 a ship with a DamCon rating of 4 accumulates 4 points for repairs and spends them all on a phaser-1, which takes 5 points. On Turn #2, the ship accumulates another 4 points and spends 1 to complete the phaser-1, the second to repair a hull box (which costs only 1 repair point) and then applies the other 2 to begin the repair of a disruptor.

On the other hand, the B10 with a damage control rating of 8 generates 8 repair points per turn but can only apply 5 to any one system and can only work on one system at a time. Since it costs 10 points to repair a range-40 disruptor, this will take two turns. However, it would be more efficient to (on the first turn) spend 3 points to repair a drone rack then the other 5 on a disruptor, then, on the second turn, spend 5 points to finish the disruptor and 3 to repair a transporter. Even so, the B10 can only repair 8 system boxes and might not want to waste one of these on a mere transporter.

**(D9.75) SIMULTANEOUS REPAIRS:** This procedure cannot be used on the same turn on the same unit as repair conducted by a repair facility (base, repair ship, or FRD) under (G17.0) or with (D14.26).

**(D9.76) LIMITATIONS:** During a given scenario, a ship can never repair more system boxes by this procedure than its original damage

control rating. This system cannot repair damage control or excess damage hits. Each shuttle (as opposed to a damage point on a shuttle) on which CDR repair points are applied counts as one "system box" repaired. Repairs by deck crews are not part of EDR or CDR. Repairs abandoned before they are complete do not count. Shield boxes repaired under this procedure do count as repaired systems, i.e., a ship with a damage control rating of four that repaired four shield boxes under this rule would not be able to repair any other systems during the scenario under these rules.

**(D9.77) SUBSEQUENT REPAIRS:** If a given box is destroyed, repaired, and then destroyed again, repairing it a second time counts as another box repaired under the limits in (D9.76).

**(D9.78) SELF-REPAIR:** This procedure can only be used by the unit on itself. It cannot be used by a ship or base on a unit docked to it. It can be used on the shuttles (including fighters, web anchors, cloaked decoys) of the ship.

**SYNOPSIS OF RULES IN OTHER PRODUCTS**

To aid in later integration of Basic Set with expansion products, these rules have with numerous cross-references to these other rules. Any rules you do not have, you can ignore.

**(D10.0) POWER ABSORBERS:** Used by Andromedan ships instead of shields. They absorb damage, convert it to power, and use it to power the ship's systems. Module C2.

**(D11.0) CHAFF:** Used by fighters to distract seeking weapons. Module J.

**(D12.0) CHAIN REACTIONS AND INTERNAL EXPLOSIONS:** Fighters (and some drone racks) in shuttle bays are subject to chain reaction explosions if damage reaches the shuttle bay. Module J.

**(D13.0) AEGIS FIRE CONTROL:** Used by carrier escorts, this fire control system allows them to fire weapons, judge the effects, and then fire other weapons during a single impulse. It is limited to engaging certain small targets. Module J.

**(D14.0) EMERGENCY DAMAGE REPAIR:** A procedure by which a ship can attempt to repair certain damage. Advanced Missions.

**(D15.0) GROUND COMBAT:** An abstract ground combat system using "areas" and "ground combat locations" to allow landing operations to proceed during a scenario. Module M.

**(D16.0) ADVANCED BOARDING PARTY COMBAT:** Each ship is divided into "areas." The boarding parties attempt to gain control of key areas and then move into other areas. Module M.

**(D17.0) TACTICAL INTELLIGENCE:** A system under which more and more information is obtained about a given enemy unit as you get closer to it. You may at first know only that it is a Klingon ship with a movement cost of 1, then observe it to be a D-series hull, then see the large hangar bay that marks it as a D7V carrier, then be shocked (when it fires plasma torpedoes) to find out it was a Romulan K7V! Advanced Missions.

**(D18.0) SURPRISE:** This is used as a special scenario rule. It places certain limitations on ships which were "surprised" while not ready for combat. Advanced Missions.

**(D19.0) PASSIVE FIRE CONTROL:** Ships can fire without active fire control, but under severe penalties. This is often used in surprise attacks. Cloaked ships cannot use it. Advanced Missions.

**(D20.0) HIDDEN DEPLOYMENT:** Used as a special rule in many scenarios, this allows a ship to "hide" in an asteroid field (or other terrain types) and ambush an enemy. Advanced Missions.

**(D21.0) CATASTROPHIC DAMAGE:** A system under which the crew of a destroyed ship, in the last microseconds before it explodes, can escape by various means. Advanced Missions.

**(D22.0) ENERGY BALANCE DUE TO DAMAGE:** A very realistic (and complex) optional system under which a ship must re-distribute its energy during the turn as power-producing systems are destroyed. Advanced Missions.

**(D23.0) SHOCK EFFECTS** used by some overgunned ships and maulers Advanced Missions.

**(D24.0) ANDRO CRITICAL HITS** for their special cases; Module C3.

**END OF SECTION (D0.0) BASIC SET**

## (E0.0) DIRECT-FIRE WEAPONS

### (E1.0) GENERAL RULES

Direct-fire weapons are those which are fired and which take effect immediately. A phaser (or cannon) is a direct-fire weapon. A drone (or missile) is a seeking weapon.

#### (E1.1) PROCEDURE

**(E1.11) WHEN:** Direct-fire weapons are fired during the Direct Fire Weapons Segment (6D) of the Impulse Procedure of an impulse. Their effects are determined and recorded immediately upon firing.

**(E1.12) ANNOUNCEMENT:** There are no counters for direct-fire weapons. A player simply indicates his ship and the target and says (for example): "I am firing my two forward phasers at your ship." Unless specified otherwise in a given weapon's description (E11.311), the player must announce the arming status of the weapon, i.e., overloaded, proximity fused, phaser-2 firing as a phaser-3, or any special rules (UIM, Derfacs), before rolling the die.

**(E1.13) SIMULTANEOUS FIRE:** Two units firing on each other during the same impulse are presumed to fire simultaneously. (The fire of both is calculated and determined before damage to either is applied.) See (D13.141) for a possible exception.

**(E1.14) SSD:** Each box on the SSD represents one weapon of the indicated type. Each box can arm and fire one shot (salvo, burst, firing, torpedo, or whatever) at a time. You cannot, for example, load two photon torpedoes in a single photon box at the same time.

**(E1.15) RANGE:** See (D1.4) for definition of true range and effective range.

**(E1.16) CLOAKS:** When firing at cloaked ships, the effect of the weapons may be reduced by (G13.37).

**(E1.17) WASTED FIRE:** A player always has the option of simply firing his weapons into open space. Doing so imposes the delays of (E.50). Note that heavy weapons may be discharged under (E1.24).

#### (E1.2) REQUIREMENTS

**(E1.21) GENERAL:** To be fired, a weapon must satisfy all requirements of the rules. Various rules and events could prevent a weapon from firing. A given weapon must be free from all prohibitions in the rules to be fired.

**(E1.211)** Each direct-fire weapon may be fired only ONCE per turn (E1.5), and then only if they have satisfied their requirements for energy (see the specific rules for each weapons type).

**(E1.212)** All direct-fire weapons have a definite field of fire which is shown on their SSD and cannot engage targets outside of their field of fire unless allowed by the rules.

**(E1.213)** Gatling phasers (E2.151), anti-drones (E5.13), maulers (E8.12), MCIDS (E6.31), and plasmatic pulsar devices (E11.33) are excepted from the limitation of firing once per turn. See the specific rules for each type of weapon.

**(E1.22) UNIT IN TARGET HEX:** The presence of a unit in the same hex as the target, or in a hex in between the firing unit and the target, has no effect. Fire is never blocked by such a unit, and the unit is never damaged by the fire. (Starships are small things compared to hexes 6,213.7 miles across.)

**(E1.221)** Planets and other terrain from section (P0.0), along with webs (G10.0), are not "units" and can block fire if their rules provide so.

**(E1.222)** Firing arcs can be blocked during docking. See (C13.72) for external docking to a base, (C13.48) when docked inside another unit, and (C13.941) for docking to another ship.

**(E1.223)** Hellbores interact with ESGs in a unique manner (G23.84) which could be seen as a partial exception to this rule.

**(E1.23) SINGLE-TARGET:** A given direct-fire weapon cannot damage several targets with the same shot. This includes targets in the same hex and targets in a row in two or more separate hexes. Weapons which miss their target never strike other targets beyond it.

**(E1.24) DISCHARGE:** Various rules require that a loaded direct-fire weapon be discharged (disposed of, unloaded, fired into empty space, allowed to dissipate in the tubes, etc.) if it cannot be fired.

**(E1.241)** This act can be conducted during any impulse or in the Final Activity Phase. It can be observed and must be announced to the other players. The amount of energy discharged from each weapon is known unless defined otherwise (e.g., R1.7). When using D17.0 Tactical Intel, this is detected at Level B, or 50 hexes for most ships.

**(E1.242)** Discharging can be done by several methods; your weapon crews will select the one most appropriate to the situation. It is never impossible to discharge a weapon. See (R1.7B) for Q-ships.

**(E1.243)** Discharging a weapon does not count as firing it for purposes of firing rates (E1.5) unless otherwise provided in the rules for a specific weapon [fusion overloads (E7.412) for example].

#### (E1.3) EFFECTS

**(E1.31) TABLES:** The effects of each direct-fire weapon are shown on the various weapons tables. The number of damage points scored by a given weapon on a given firing depends on the type of weapon, the range, and a die roll.

**(E1.32) HIT-OR-MISS WEAPONS:** Some direct-fire weapons, such as photon torpedoes and disruptor bolts either hit or miss their targets. These are called "hit-or-miss" weapons because the target either receives the full effect or none at all.

**(E1.33) RANGE-OF-EFFECTS WEAPONS:** Other direct-fire weapons, such as phasers, score a variable number of points at a given range under given conditions.

#### (E1.4) FINALITY OF EFFECT

There is no counter-weapon to a direct-fire weapon. While clever maneuvers will restrict your opponent's ability to get in a decisive shot, and your shields will reduce the damage he causes, there is nothing that can be done directly against the fire of the weapon. [You could reinforce shields after a weapon is fired under (H7.34) to mitigate the damage.]

#### (E1.5) FIRING RATES

**(E1.50) BASIC RULE:** No weapon may be fired twice within a period of one-fourth of a turn. (Note that, in most cases, this involves firing the weapon on two consecutive turns.) For example, if a specific phaser were fired during Impulse #29 of one turn, it could not be fired again before Impulse #5 of the next turn. This rule is NOT to be interpreted as meaning that a weapon can be fired more than once per turn. It is intended to eliminate the unrealistic tactic of firing a "full broadside" on Impulse #32 of one turn and then repeating it on Impulse #1 of the next.

**(E1.51) RAPID FIRE:** Certain weapons (E1.213) are specifically capable of being fired more, or less, rapidly. Specific rules for specific weapons will take precedence over (E1.5), for example (E2.151) Gatling Phasers.

**(E1.52) EXAMPLE:** A weapon is fired on Impulse #25. It must wait through Impulses #26 (1), #27 (2), #28 (3), #29 (4), #30 (5), #31 (6), #32 (7), and then could fire on Impulse #1 (8 impulses later) of the next turn. For this reason, Impulse #25 is often known as the "Impulse of Decision" because it is the last impulse on which most weapons can fire and still be able to fire on the first impulse (known as the "Impulse of Truth") of the next turn. The "Impulse of Truth" will often be critical because ships can switch power from movement into weapons and fire full overloaded salvos with no chance for the target to change shield facings.

**(E1.6) NARROW SALVOES (Advanced)**

Two or more direct-fire weapons (unless otherwise noted in the rules) can be fired in a narrow salvo. This is basically an "all or nothing" proposition, i.e., all of the weapons of the salvo will use the same die roll. Usually, weapons fired simultaneously are fired into a pattern that will insure at least some hits on the target but preclude maximum effect. Narrow salvos concentrate the fire of weapons onto a single point. While there is less chance of success, that success can be devastating.

Most players who use narrow salvos use them at the wrong time against the wrong target. In general ship-vs-ship combat, there is virtually no occasion in which their use is tactically advantageous. It will take several salvos to destroy the enemy, and using narrow salvos only creates the statistical possibility that all of them could miss.

The only valid use for narrow salvos is in those cases where "some" damage would actually be worse than "no damage" to a given target. For example, damaging a scatter-pack (FD7.0) will cause it to release its drones, while destroying it would be preferable. Another example might be combat against an Andromedan ship, in which case damage insufficient to penetrate the power absorber panels would simply give the Andromedan more power to use against you. Narrow salvos might be used effectively at long range when the enemy is known to have a few points of reinforcement, as any damage which does not penetrate this reinforcement is often meaningless.

**(E1.61) CONDITIONS:** Only direct-fire weapons of a single type being fired by a single ship during a single impulse in a single volley at a single target can be concentrated into a narrow salvo. See the specific rules for each weapon for exceptions and restrictions.

**(E1.611)** While normal and overloaded weapons (of a single type) could be fired together in a narrow salvo, proximity and non-proximity photons cannot.

**(E1.612)** Different types of phasers CAN be combined in a narrow salvo; the same die roll result is used on each of the various tables. Different types and sizes of plasma bolts can be fired in a narrow salvo.

**(E1.613)** Disruptors of different ranges on the same ship [which can happen with hasty repairs (G17.5) or a Klingon battle tug] can be combined into a narrow salvo. Overloaded and normally loaded disruptors can be combined into a narrow salvo. Disruptors fired with or without DERFACS or UIM support could be fired in a narrow salvo.

**(E1.614)** A narrow salvo must all be fired at the same instant, i.e., during the same impulse, and all must be committed to fire before the die is rolled.

**(E1.62) PROCEDURE:** Resolve the fire of one weapon normally. All other weapons in the same narrow salvo use the same die roll. (i.e., you simply roll one die, and use that result for each weapon. If you score one hit, you score several.)

**(E1.63) OTHER NARROW SALVO RULES**

**(E1.631)** A player using a narrow salvo for some of his weapons is not required to use it for all of his weapons, even if fired at the same target during a single impulse.

**(E1.632)** Seeking weapons cannot be fired in narrow salvos.

**(E1.633)** A given ship can fire two or more narrow salvos at the same target (or several different targets), even during a single impulse, but must roll a separate die for each one.

**(E1.624)** A given target might be struck on the same impulse with any number of weapons (narrow salvoed or otherwise) from any number of firing units. These would be combined into volleys (D4.22) for purposes of damage allocation within the provisions of (D4.0).

**(E1.625)** If two or more ADDs are narrow-salvoed at a shuttle, roll one die to see if there is a hit and then roll separately for the effect of each ADD that hit.

**(E1.7) SMALL TARGET FIRING MODIFICATIONS**

Due to their small size and normally agile maneuvers, drones and fighters are difficult targets to hit at long range. When firing at certain types of units with direct-fire weapons, these "small targets" receive ECM (Electronic Counter Measures) points to reflect the difficulty in hitting them:

Target Type	ECM points at Stated Effective Range		
	none	+2	+4
Admin Shuttle, SWAC, MSS, MRS, MLS, HTS, GAS, Heavy Fighters	0 – 11	12 – 24	25+
Fighter, Drone	0 – 9	10 – 19	20+
Nimble ship†	0 – 14	15 – 29	30+

These are considered as ECM points from a natural source (D6.3143) and are not included in the self-generated limit or the received from lending limit. Small Target Modifiers are based on the effective range (D1.4).

† See (C11.0) for rules, Annex #7F for a list of such ships. Ships include PFs and Interceptors. Shuttles are nimble units but are handled separately for (E1.7).

**(E1.71) CUMULATIVE:** These effects are not cumulative with the effects of erratic maneuvers (C10.4); the player owning the target unit may decide which to use. They are cumulative with specific weapons penalties when firing at drones (FD1.5). They are cumulative with electronic warfare (D6.3).

**(E1.72) SEEKING WEAPONS:** Seeking weapons fired at small targets are unaffected by this rule.

**(E1.8) DIE ROLL MODIFIERS**

There are several rules which can produce die roll modifiers. These change the probability of a hit or damage.

**(E1.81) SOURCES OF DIE ROLL SHIFTS:** Several rules can produce die-roll shifts.

**(E1.811) ELECTRONIC WARFARE:** The primary source of die roll modifiers is electronic warfare (D6.3), which includes numerous effects. Most modifiers are expressed in terms of EW points, for example, small targets (E1.7), specific weapons fired at drones (FD1.5), poor crew (G21.111), outstanding crew (G21.211), etc., all of which are cumulative and part of the overall EW rules.

**(E1.812) LEGENDARY WEAPONS OFFICER (G22.72)** has a die roll modifier of -1 for direct-fire weapons. This modifier is combined with any other modifiers to determine the single combined modifier. It is not ECCM.

**(E1.82) EFFECT OF DIE ROLL SHIFTS:** Die roll shifts are applied as follows:

**(E1.821) HIT-OR-MISS WEAPONS:** For hit-or-miss weapons (photon, disruptor, hellbore, plasma bolt, plasmatic pulsar wavelock), positive modifiers (e.g., +1) are simply added to the die roll. If the result is more than the "to hit" number, the weapon misses.

**(E1.822) RANGE-OF-EFFECT WEAPONS:** In the case of "range of effect" weapons (phasers, fusion beams, TR beams), a positive modifier is added to the die roll. If the result exceeds the highest number on the chart (usually 6), take any additional shifts by moving to the highest numbered result on the next higher range column (one column per shift).

**EXAMPLE:** Nine ECM points have produced a die roll modifier of +3 applied to the firing of a phaser-1 at range 3. The die roll is 4, which would normally result in 4 damage points. Two of the three ECM shifts are used to raise the die roll from 4 to 6, the third is used to increase the range to the next column (range 4). The adjusted result is two points of damage (die roll 6, range 4). If the original die roll had been 2, the final result would be die roll 5, range 3. If the original die roll had been 6, the final result would be die roll 6, range 6-8.

**(E1.823)** MAULERS have a "to hit" number of 2-12 with two dice. Roll two dice and add the modifier. A result of 13 or more is a miss. See (E8.24).

**(E1.83) NEGATIVE MODIFIERS:** A negative die roll modifier cannot reduce a die roll below 1. If there is a negative modifier (e.g., -1 from a legendary officer) and the die roll is 1, the modifier is ignored. Do NOT shift to a lower range column.

## (E2.0) PHASERS

The phaser is the primary weapon of most starships in the game. It is a phased energy beam which, when striking the target, does physical damage due to its kinetic force and also creates an electrical discharge that can burn out various systems. There are five types of phasers, each of which uses a different table when fired at an enemy ship or other target.

### (E2.1) TYPES OF PHASERS

**(E2.11) TYPE I - OFFENSIVE PHASER:** This is the most powerful type of phaser carried by starships, causing considerable damage out to as much as 8 hexes. It costs one unit of energy to fire a phaser-1 one time.

The terms phaser-I, phaser-1, ph-1, and ph-I are used interchangeably, although ph-1 is the most common.

**(E2.12) TYPE II - OFFENSIVE-DEFENSIVE PHASER:** These are shorter-ranged than phaser-1s due to less accurate fire control. It costs one point of energy to fire a phaser-2 one time. Many ships equipped with phaser-2s were later refitted with improved fire control, improving some of their ph-2s to ph-1s.

The terms phaser-II, phaser-2, ph-2, and ph-II are used interchangeably, although ph-2 is the most common.

**(E2.13) TYPE III - POINT DEFENSE PHASER:** This type of phaser is the least powerful of all, having an effective range of only one or two hexes. They were designed to be used against drones. In practice they are often used against other ships in combat, but are, of course, less effective. The phasers carried by administrative shuttles (J2.213) and many fighters use the phaser-3 table. It costs 1/2 unit of power to fire a ph-3 one time. This cost is used even if fractional accounting (B3.2) is not used; most ph-3s are in pairs so the calculation will be simplified.

The terms phaser-III, phaser-3, ph-3, and ph-III are used interchangeably, although ph-3 is the most common.

**(E2.14) TYPE IV - HEAVY PHASER:** A very powerful model used only on bases. It costs two units of power to fire a phaser-4 one time.

Due to the fire control system, which requires positional stabilizers (G29.26), ships can never carry a ph-4; only bases with stabilizers can use it. (Several monsters in SFB use the phaser-4 table to approximate other weapons.)

Orions can never have ph-4s under any circumstances.

The terms phaser-IV, phaser-4, ph-4, and ph-IV are used interchangeably, although ph-4 is the most common.

**(E2.15) TYPE G - GATLING PHASER:** A particularly vicious weapon developed by the Hydrans and later copied (to a limited extent) by the Federation and some pirates.

The terms phaser-G, and ph-G are used interchangeably, although ph-G is the most common.

**(E2.151)** A gatling phaser can be fired up to four times during a single turn. Each firing may be during the same or a different impulse and at the same or a different target. Gatling phasers can fire at different targets in the same impulse. A gatling phaser cannot fire more than four shots per turn, nor can it fire more than 4 shots within a 1/4-turn period. The 1/4-turn period can include some shots fired during the final portion of one turn and some shots fired during the early portion of the subsequent turn.

**(E2.152)** The effect of a phaser-G is determined on the phaser-3 table. Each firing costs 1/4 of an energy unit (a total of 1 point for all four shots). Fractional accounting (B3.2) can be used if only 1-3 shots are fired on a given turn.

**(E2.153)** Two or more shots from a single gatling phaser can be combined into a narrow salvo (E1.6), possibly with other phasers.

### (E2.2) RESTRICTIONS AND CONDITIONS

**(E2.21) AVAILABILITY:** A given ship may fire any number of its phasers in a given impulse, assuming that energy has been allocated, is available from the reserve (H7.52), or stored in the capacitors (H6.0) for this purpose and that other rules (e.g., firing arcs, firing rates, fire control, friendly fire, etc.) are satisfied.

**(E2.22) ENERGY:** Players must allocate energy in the Energy Allocation Phase or have reserve power (H7.52) available to be able to fire their phasers. The power must pass through the phaser capacitor system to be used for phasers. See the rules on energy allocation (B3.0) and phaser capacitors (H6.22) for more details. See also (H7.36).

**NOTE:** Shuttles and fighters do not pay energy to fire their phasers.

**(E2.23) FREQUENCY:** During each turn, each phaser on the ship may be fired no more than one time [exception: gatlings (E2.151)]. Note that all phasers have a specific field of fire (D2.0), and that a ship might not have targets for all of its phasers on a given turn. Possible fields of fire for the ensuing turn should be considered when planning how much energy to allocate to firing phasers.

**(E2.24) SSD:** Each box on the SSD represents one phaser and can be destroyed by a single internal damage point allocated to phasers. Most, but not all, phasers are arrayed in "banks" of two or more connected boxes; each box operates independently although all boxes of a given bank have the same firing arc.

**(E2.25) LOW-POWER:** Phasers can be fired at low power. This may be done to save power, or because there is not enough power, or because of special scenario rules, or other tactical considerations, such as to avoid blinding special sensors (G24.34). A low-powered firing counts as the single firing of that phaser for that turn. This rule does not imply that ph-1s, ph-2s, or ph-4s can be fired more than once per turn in this mode.

**(E2.251)** Any ph-1, ph-2, or ph-4 can be fired as a ph-3 by using only 1/2-unit of power. See (B3.2).

**(E2.252)** A ph-4 could fire as a ph-1 or ph-2 for one point of power.

**(E2.253)** A ph-1 could be fired as a ph-2 although the only reason to do so would be as a means of deception (D17.76) as to the class or refit status of an incompletely identified ship.

### (E2.3) ENERGIZING PHASERS

**(E2.30) PROCEDURE:** Before phasers can be fired, they must be energized (i.e., "warmed up"). Ships do not normally enter "peacetime conflict" scenarios with their phasers energized because they were not expecting to face combat; this is Weapon Status 0 as defined in (S4.1). When at Weapon Status 0, the ship will be unable to fire phasers on the first turn of the scenario. The typical patrol of a cruiser has been described as "six months of boredom and an hour of stark, screaming terror." Without knowing when that hour will come, the ship can ill afford to burn fuel keeping weapons ready to fire. When a ship is in a potential danger area, the captain may order Weapon Status 1 (S4.1) which keeps the phasers energized.

In wartime, or when the ship has been summoned to the point of battle, scenarios will often specify a Weapon Status of 1 or higher.

**(E2.31) COST:** It costs one point of energy for one turn to energize all of the phasers (of all types) on board a given ship. During and prior to that turn, no energy may be allocated to the phasers (other than the energy to energize them) or stored in the capacitors of that ship. This point of power is used to energize the phaser capacitors; it cannot be used to fire the phasers. It does not go into the capacitors.

**(E2.32) MAINTAINABILITY:** The capacitor system of a unit remains energized for 25 turns after the last time a phaser was fired or one point of energy was expended for energization. Energy already in the capacitors could be expended to re-energize them. If the phaser capacitor system becomes non-energized, all power in the capacitors is lost. If an individual phaser is destroyed and subsequently repaired,

it is already energized if the system is still energized (and can have energy stored in its capacitor). If all of the phasers are destroyed at a given point in time, the phaser capacitor system will still remain energized for the normal period, although it will hold no energy and cannot be re-energized if it becomes non-energized (unless part of it is repaired).

**(E2.33) ENERGIZING WITH RESERVE POWER:** A ship at Weapon Status 0 (capacitors unenergized) could begin energizing them with reserve power in mid-turn (perhaps after detecting an unexpected enemy). The phasers cannot be fired until 32 impulses after this energizing is begun although power can be allocated to the capacitors on the next Energy Allocation Phase.

### (E2.4) FIRING PHASERS

**(E2.41) PROCEDURE:** When firing phasers, first determine the range to the target (D1.4). Note that the effective range may be different from the true range due to the effects of cloaking devices (G13.0), sensors (D6.1), scanners (D6.2), etc. Then roll one die [the die result may be adjusted by electronic warfare or other effects; see (E1.8)] and cross-index the result with the range on the appropriate phaser chart (page 216) to yield the number of damage points scored.

**(E2.411) EXAMPLE #1:** A phaser-3 is being fired at a target three hexes away. There is no electronic warfare. The die roll is "2" which means that two points of damage have been scored.

**(E2.412) EXAMPLE #2:** A phaser-1 is being fired at a ship one hex away. However, the ship does not have lock-on, so the range is doubled to two hexes. Further, the firing ship's scanners have been damaged, and it has a scanner rating of 1, yielding an effective range of three hexes. The die is rolled and the result is a "1," which would normally mean six damage points (it would have been eight if the fire control systems had been working and the effective range shorter). In this case, however, there is one electronic warfare shift (D6.3), which increases the die roll to "2" and yields five damage points.

**(E2.42) OVERLOADS:** Phasers cannot be overloaded. Exception: X-ships (XE2.42). See (H7.525).

## (E3.0) DISRUPTOR BOLTS

Disruptor bolts are carried by Klingon, Tholian, Lyran, and Kzinti ships. (Certain other ships, notably the Orion Pirates and the WYN, also use disruptors on some of their ships.) Disruptors operate on the principle of an energy discharge. They do less damage with a single shot than photon torpedoes, but can be fired more often.

The comparison between disruptors and photon torpedoes (E4.0) explains the difference in "combat style" of the Federation and Klingons. Federation ships run in on the target and unload a devastating barrage of photon torpedoes, then must pull out of range to reload. Klingon ships, with their faster firing but less damaging weapons, prefer to use maneuver and speed to repeatedly close range and fire, then pull away (briefly) to reload.

### (E3.1) DESIGNATION

Each "DISR" box on the SSD represents one disruptor bolt. Each is recorded and fired separately.

### (E3.2) ARMING PROCEDURE

**(E3.20) PROCEDURE:** Disruptor bolts are fired by the following procedure. Two units of energy are allocated for each bolt which is to be fired. The bolts are an energy discharge and as such cannot be held from one turn to the next. Any bolts for which energy has been allocated, but which have not been fired by the end of the turn, are lost.

**(E3.21) SOURCE:** Energy to fire disruptor bolts can come from any power source. This can be allocated or reserve power.

**(E3.22) FIRING:** Disruptor bolts are fired during the Direct-Fire Weapons Fire Stage of the Impulse Procedure. There is no counter

for a disruptor bolt. Their effect is determined by die roll and recorded immediately.

**(E3.23) RATE:** A given disruptor bolt may not be fired more than once per turn.

**(E3.24) HOLDING:** Armed disruptors cannot be held and fired on a later turn. If energy is allocated to fire a disruptor, and it is not fired on the turn of arming, the energy is lost and cannot be regained. This discharge does not constitute firing the weapon and does not delay firing the weapon (with different energy) on the next turn.

### (E3.3) FIRING PROCEDURE

**(E3.31) PROCEDURE:** The number of damage points scored by the disruptor bolt is determined by the range, the firing characteristics of the weapon being fired, and a die roll. Refer to the DISRUPTOR BOLT CHART (E3.4).

Determine whether standard or overloaded disruptors are being fired and whether normal, UIM, or DERFACS fire control is being used and determine from this which line on the disruptor chart to use. Using the range, determine the hit probability for this weapon configuration.

Roll a single die. If the result is within the range of probabilities listed, the weapon has hit, scoring a number of damage points as shown on the bottom lines of the chart.

**(E3.32) RANGE:** The maximum range of disruptors (expressed in terms of effective range) is different with each ship class that carries them. Basically, all disruptors are the same, but those on larger ships have more stable firing platforms and better fire control. Refer to Annex #8A. All disruptors on a given ship will have the same range unless some have undergone hasty repairs (G17.5).

Disruptors cannot be fired at range zero; exception: overloads (E3.5).

**(E3.33) RANGE EFFECTS:** When the effective range of a disruptor bolt is different from the true range, use the effective range to determine the probability of a hit and the true range to determine the number of damage points scored.

### (E3.4) DISRUPTOR BOLT COMBAT CHART

See MASTER WEAPONS CHART on page 216.

### (E3.5) DISRUPTOR OVERLOADS (*Advanced*)

Disruptor bolts may be overloaded. This requires more energy, but increases the damage effect.

**(E3.51) ALLOCATION:** The energy to fire an overloaded disruptor bolt (2 points for the normal load plus 2 more points for the overload) can be allocated at the start of the turn or provided from reserve power. (Reserve power could provide all of the energy, or just the overload portion.) Once energy is allocated to overload a disruptor, it cannot be fired as a non-overloaded one; see (H7.64). As with standard disruptors, it cannot be held, so it must be fired or discharged before the end of the turn. Whether fired or discharged, it could be armed and fired (as a standard or an overloaded bolt) on the next turn. It is not possible to discharge an overloaded disruptor and then (during the same turn) fire a normal loaded with reserve power; see (H7.525).

**(E3.52) EFFECT:** The warhead strengths of overloaded disruptors are doubled. This is shown on the MASTER WEAPONS CHART.

**(E3.53) MAXIMUM RANGE:** The maximum range of an overloaded disruptor bolt is 8 hexes regardless of the original range of the weapon. This range limitation applies to true range, not to the adjusted range. See (D6.126).

**(E3.54) RANGE ZERO, FEEDBACK:** Overloaded disruptors can be fired at range "0." The hit probability is 1-6, insuring a hit (unless other factors, such as electronic warfare, produce a die roll modification). If an overloaded disruptor scores a hit at a true range of "0," two points

of damage are scored on the facing shield of the firing ship. This does not reduce the amount of damage done to the target or affect any other ship. Like overloaded photons (E4.43), the damage is caused by the ionized ether trail from the launcher to the target.

**(E3.55) RESERVE POWER** can be used to overload a disruptor (H7.54).

### (E3.6) ADVANCED FIRE CONTROL SYSTEMS

In an attempt to improve the firepower of their ships, the Klingons and other races have developed several advanced fire-control systems for their disruptors. Both UIMs and DERFACS require active fire control and a lock-on.

**(E3.61) UBITRON INTERFACE MODULES** can be used to increase the effectiveness of disruptor fire at medium ranges and when firing overloads; see (D6.5) for complete instructions.

**(E3.62) DISRUPTOR EXTENDED-RANGE FIRE ATTENUATION CONTROL SYSTEM (DERFACS)** was designed to improve the long-range firepower of Klingon ships. All disruptor fire at effective ranges of 23-30 is resolved as if the effective range was 22. Most disruptor charts have a line for this fire control system. DERFACS cannot break down (as the UIM can), but can be destroyed by a hit-and-run raid (D7.8). DERFACS is automatically repaired at no cost between scenarios. This system is available (at no cost) to all disruptor-armed ships with a range of 30 or more in Y168 (Klingon ships Y165, Lyrans Y166).

### (E4.0) PHOTON TORPEDOES

Photon torpedoes are carried by Federation ships and certain others. They are considered to be the heavy weapons of the ship, but because they must be armed in advance and cost a considerable amount of energy to hold in the launch tubes if they are not fired immediately, their use is normally restricted to heavy combat situations. A photon-armed ship does not normally keep the torpedoes armed because of the energy requirement to simply hold them in the tubes.

#### (E4.1) FIRING PHOTON TORPEDOES

Each "PHOTON" box on a Federation ship's SSD represents one photon torpedo launch tube. Each tube is armed and kept track of separately. A given photon torpedo tube cannot be used to arm, hold, or fire more than one photon torpedo at a time. The maximum firing rate for a Federation heavy cruiser, for example, is four torpedoes in each two-turn period.

**(E4.11) FIRING:** Photon torpedoes are fired in the Direct-Fire Weapons Fire Stage of the Impulse Procedure, and their effect is determined immediately by die roll. There are no counters for photon torpedoes.

**(E4.12) HIT:** Consult the Photon Torpedo Table on the Master Weapons Chart (page 216). To determine if a photon torpedo has hit the target, consult the photon torpedo table and look under the effective range. Roll a single die. If the result (as adjusted by electronic warfare or other factors) is between the listed hit numbers (inclusive), the torpedo has hit its target.

**EXAMPLE:** A die roll of 4 is within the hit numbers listed (1-4) for range 3, so the torpedo would score a hit at a range of 3 with a die roll of 4.

**(E4.13) DAMAGE:** Regardless of range, a photon torpedo does 8 hit points of damage if it hits. Exceptions, see (E4.33), (E4.41), and (G13.37).

**(E4.14) MINIMUM RANGE:** Even when firing without a "lock-on" (where the range would be doubled), photons cannot be fired at a true range of one hex or less. Exception, see overloads (E4.43).

**(E4.15) SPECIAL FIRING:** Photon torpedoes can be fired in a narrow salvo (E1.6). Overloaded and non-overloaded torpedoes can be combined in a narrow salvo; proximity and non-proximity torpedoes cannot.

#### (E4.2) OPERATIONS

**(E4.21) ARMING:** To arm a photon torpedo, two points of warp energy must be allocated to a specific photon torpedo tube on each of two consecutive turns. The second turn may be the turn of firing. The Federation heavy cruiser, which has four photon tubes, would have to expend eight units of warp energy on each of two consecutive turns to fire a full spread of four torpedoes (and more power if overloading).

This arming cycle *must* be two points on each of two turns (2+2); it cannot be done by loading 0 or 1 or 3 or 4 points on one turn and the balance on the next, or in any combination on two non-consecutive turns.

**(E4.22) HOLDING ARMED TORPEDOES:** If the arming of a photon torpedo has been completed on a given turn, and the torpedo is not fired on that turn, then the ship must either discharge the weapon (E1.24) or allocate one unit of energy each turn to hold the torpedo in the tube for each turn until the torpedo is fired (including the turn of firing). Partially armed photons (those that have received only one turn's arming energy, possibly including some overload energy) cannot be held.

**EXAMPLE:** On Turn #5, two units of energy are allocated to a photon tube. On Turn #6, two more units are allocated, and the torpedo is considered armed from the start of the turn. If two units of energy had NOT been allocated, the torpedo would have been discharged automatically (E1.24), and arming must begin again. Assuming that arming was completed during the Energy Allocation Phase of Turn #6, the torpedo could have been fired during any impulse of Turn #6. If not, then during the Energy Allocation Phase of Turn #7, the ship must either expend one unit of energy to hold the torpedo in the tube or discharge the torpedo. If not fired on Turn #7, another unit of energy must be allocated on Turn #8 to hold the torpedo in the tube, or again the torpedo would have to be ejected (E1.24).

**(E4.23) ENERGY REQUIREMENT:** The four points of energy to arm a photon torpedo (and any used to overload it) **MUST** all come from the warp engines and/or warp reactors. The power to hold it may come from any source.

#### (E4.3) PROXIMITY FUZE (*Advanced*)

Photon torpedoes may be fitted with a proximity fuse. This increases their chance of a hit at longer range but reduces their effectiveness.

**(E4.31) RECORDS:** A photon torpedo that is to carry a proximity warhead must be recorded as such when the second turn's arming is recorded, or when holding energy is paid on a subsequent turn. This is done by marking a "P" in the space on the Energy Allocation Form for the turn on which the proximity fuse is fitted. It must be announced as such when fired. There is no cost (energy, victory points, or expenditure of supplies) for this type of fuse. The proximity fuse can **ONLY** be installed or removed during an Energy Allocation Phase.

**(E4.32) EFFECT, MINIMUM RANGE:** Proximity-fused photon torpedoes automatically miss at all true ranges (not effective ranges) less than nine hexes. At ranges of nine or more hexes, two is subtracted from the die roll when rolling to determine if the torpedo has hit. Note that many photon torpedo tables have a "Proximity" line which has this die roll adjustment already built in. Example: A proximity torpedo would hit on a die roll of 1-3 (not 1-5) at range 25; a normal torpedo would hit on a die roll of 1.

**(E4.33) WARHEAD:** The strength of a proximity-fused photon torpedo is four instead of the normal eight. This accounts more for the fact that the weapon has exploded some distance from the target than any actual change in warhead yield.

**(E4.34) ARMING:** Proximity-fused photons that have just been fully charged or are being held could be changed to normal types, and vice-versa, during the Energy Allocation Phase (E4.31). There is no energy cost for the changeover. Note, however, that proximity-fused photons cannot be overloaded. It is possible to convert a proximity-fused torpedo to an overloaded type. Simply remove the proximity fuse during the Energy Allocation Phase and then (in that same phase or a later one) add overload energy by allocation or (later in the turn) by reserve power (H7.54).

It is not possible to convert an overloaded torpedo to a proximity-fused type because there is no way to "un-overload" the weapon once it is overloaded. It is not possible to fire a photon torpedo with both overload and proximity functions.

**(E4.4) OVERLOADS (Advanced)**

Ships that carry photon torpedoes have the option of "overloading" them. This involves using extra energy to arm them. This increases their power, but limits their range.

**(E4.41) LEVELS OF OVERLOAD:** Photon torpedoes can be overloaded by up to 100%.

**(E4.411)** During the arming process for a normal photon torpedo, a total of four units of warp energy is applied to charging the torpedo (two on each of two consecutive turns). If additional warp energy (up to four points in increments of one-half point) is applied during the two-turn arming process or while the torpedo is being held in the tube, this energy has the effect of overloading the torpedo. This overload energy may be applied during the first and/or second turn of arming and/or any later turn in which a loaded torpedo is held. Note that while overload energy (up to the maximum of four points) can be applied in the first turn of arming, this irrevocably commits the torpedo to be an overloaded torpedo (unless it is discharged). Discharged is defined in (E1.24).

The table below shows some of the legal possibilities for arming and overloading photon torpedoes.

TORPEDO	TURN #1	TURN #2
#1	2+0	2+4
#2	2+2	2+2
#3	2+4	2+0
#4	2+1	2+3

All of the above would produce a fully overloaded torpedo. The energy is shown as Standard+Overload. The overload energy in any of the examples could be reduced (and possibly replaced during allocation of Turn #3 or later or with reserve power). The overload energy can be added in half-point increments using fractional accounting (B3.2).

**(E4.412)** Energy paid to hold the torpedo in the tube (E4.44) does not count for overloading. If a torpedo is completed on one turn and overloaded during the Energy Allocation Phase of the next turn, holding cost must be paid on that turn.

**(E4.413)** The strength of an overloaded torpedo is determined as follows:

Total Energy	Warhead Strength	Feedback	Hold Cost	
			Standard	Fractional
4.5	9	1	2	1-1/4
5	10	1	2	1-1/4
5.5	11	2	2	1-1/2
6	12	2	2	1-1/2
6.5	13	3	2	1-3/4
7	14	3	2	1-3/4
7.5	15	4	2	2
8	16	4	2	2

**(E4.42) MAXIMUM RANGE:** The maximum range of an overloaded photon torpedo is 8 hexes. The weapon is unstable and will dissipate at that point. The range limitation applies to true range, not to the effective range.

**(E4.43) FEEDBACK DAMAGE:** Overloaded photon torpedoes may be fired at a true range of 0 or 1. At these ranges, the hit probability is 1-6. Note that electronic warfare (D6.3) and other conditions might still result in a miss.

**(E4.431)** If an overloaded photon torpedo scores a hit at a range of 0 or 1, damage is scored on the facing shield of the firing ship. The amount of damage is shown in the "feedback" column above. The ionized ether trail from the firing ship to the target (created by the passage of the torpedoes) conducts some of the blast back to the firing ship. If the weapon misses the target, there is no damage to the firing ship.

**(E4.432)** The feedback damage is not subtracted from the warhead strength.

**(E4.433)** No other ship, regardless of its location proximate to the firing or target ship, takes damage as a result of this effect.

**(E4.44) HOLDING:** Overloaded photons may be held in the tubes. The holding cost is shown in the chart in (E4.413). The holding energy does not have to be warp energy.

**EXAMPLES:** Torpedo #1 was armed to normal strength during Turns #1 and #2 but not fired. During the Energy Allocation Phase of Turn #3, 1 point of holding energy was paid. Later in Turn #3, reserve power was added to create an overload. It was not necessary to pay additional holding energy for Turn #3, but if the torpedo is not fired on Turn #3 holding energy at the overload level must be paid during the Energy Allocation Phase on Turn #4.

Torpedo #2 was armed during Turns #1 and #2 but not fired. During the Energy Allocation Phase of Turn #3, 2 points of overload energy was applied, and the holding cost of 1.0 was also paid. If not fired on Turn #3, holding energy of 1.5 points must be paid during the Energy Allocation Phase on Turn #4.

**(E4.45) OVERLOADING WITH RESERVE POWER:** A photon that has completed arming could be overloaded during the turn using reserve power (H7.54). However, this must be reserve warp energy (H7.48). This could be done at the point of firing.

**(E5.0) ANTI-DRONES**

Some ships carry a special drone rack that is loaded with short-range hyper-velocity missiles used to destroy incoming drones. This is known as an "Anti-Drone Defense System" (ADD).

An anti-drone is *not* a drone and is not treated as such; it is a direct-fire weapon. Anti-drone systems are, however, destroyed on "drone" hits and can fire type-VI drones, causing no end of confusion on this point.

**(E5.1) ADD RACKS**

**(E5.11) SSD:** Each ADD box on the SSD represents one ADD rack.

**(E5.12) AMMUNITION:** The anti-drone rack contains six anti-drones; once this ammunition is exhausted, the rack cannot be fired again until reloaded. (Some ships have larger magazines. If so, this is stated in the specific rules on that ship.)

**(E5.13) FIRING:** An ADD rack can fire one ADD per impulse. All ADDs have 360° firing arcs.

**(E5.14) LOCK-ON REQUIRED:** If a ship does not have lock-on, its ADD cannot fire.

**(E5.15) ELECTRONIC WARFARE:** Anti-drones ignore EW effects. Note that they can be affected by erratic maneuvers (C10.49) performed by the ship they are installed on.

**(E5.16) SCANNERS:** The scanner (D6.2) factor (usually zero until damage is scored on the ship) is added to the die roll, not the range, for ADDs.



**(E5.2) OPERATION**

Anti-drones are direct-fire weapons normally used to fire at drones. Fire is resolved by the ANTI-DRONE PROBABILITY OF HIT CHART (E5.6) below.

**(E5.21) PROCEDURE:** The player firing the ADD designates the drone that is the target and rolls one die. If the result is within the range of hit probabilities for that range on the chart, the ADD has hit the target. A "hit" by an ADD automatically destroys the drone at which it was fired regardless of the type of drone, armor modules, etc.

**(E5.3) ALTERNATIVE TARGETS**

**(E5.31) SHUTTLES:** An ADD can be fired at shuttles (which includes fighters), but if a hit is scored, a die must be rolled. The result is the number of damage points scored on the shuttle. The ADD does not actually have an "explosive warhead" as a drone would (it uses a cluster of kinetic pellets released just prior to expected impact), and a shuttle, being much larger than a drone, can (possibly) survive the damage it causes. ADDs fire at a DEFSAT as against a shuttle.

**(E5.32) OTHER TARGETS:** The ADD warhead is too small to score even a single damage point on a ship, base, PF, asteroid, ESG field, or anything larger than a shuttle or drone. An ADD cannot be fired through an ESG field and cannot damage that field.

**(E5.33) MINES:** Anti-drones can be fired at mines (scoring damage as against a shuttle) under the standard restrictions (range 1, held in tractor, roll for number of damage points), but this is not recommended as the mine will "trigger" and explode OR if a captor will fire/launch on the next direct-fire or seeking weapons launch phase as appropriate.

**(E5.4) ALTERNATIVE AMMUNITION**

**(E5.41) DOGFIGHT DRONES:** Ships may load type-VI drones in the ADD launcher. These can be mixed with the anti-drones on a one-for-one basis, paying 0.25 BPV points for each such substitution (plus any speed-cost adjustments for the type-VI drones) as a Commander's Option (S3.2). Alternatively, type-VI drones on the ship for some other reason (fighter storage, extras bought as Commander's Options, type-E racks, etc.) could be used as reloads in the ADD. These are targeted by the ADD's computer and can only be launched if the target is within six hexes of the firing ship.

**(E5.42) FIRING:** A single ADD can only launch one type-VI drone per turn and cannot launch type-VI drones and ADDs in the same turn. There is an 8-impulse delay between firings when switching modes between turns, similar to that for the G-rack.

**(E5.43) EM RESTRICTION:** ADD racks cannot launch type-VI drones while the ship is doing EM.

**(E5.5) TYPES OF ANTI-DRONE RACKS**

There are four types of anti-drone racks:

**(E5.51) ADD-6:** This is the original type, holding six rounds of ADD ammunition.

**(E5.52) ADD-12:** This is the improved version, seen on newer ships and base stations, which holds 12 rounds of ammunition. Virtually all ADD-6s were converted to ADD-12s in the Y175 refits.

**(E5.53) ADD-30:** This is the large version used on starbases and battle stations (FD3.86). It has five six-round magazines and can draw from any one magazine.

**(E5.54) G-RACK:** This is a special drone rack that can fire anti-drones, type-VI drones, or standard drones. Refer to rule (FD3.7) for information on this rack.

**(E5.6) ANTI-DRONE PROBABILITY OF HIT CHART**

**(E5.61) CHART:** Roll one die for each ADD shot. Look under the range column to determine if the shot hit or missed the target.

RANGE	0	1	2	3	4+
HIT	—	1-2	1-3	1-4	—
MISS	1-6	3-6	4-6	5-6	1-6

**(E5.62) MODIFIERS** applied to the die roll include:

Erratic Maneuvers: +1 shift if the firing ship is performing EM; see (C10.49).

Scanners: The scanner factor (E5.16) is added to the die roll.

Officers: A legendary weapons officer subtracts one from the die roll; see (G22.7).

Crew: Poor crew adds one to the die roll (G21.111); outstanding crew subtracts one (G21.211).

Cumulative: Outstanding crew and legendary officer modifiers are not cumulative.

**(E5.7) RELOADING**

**(E5.71) RELOADS:** All ships equipped with ADD racks have two complete sets of reloads for the rack. (While the Y175 refit increased the number of reloads from 12 to 24, this was a function of the larger rack.) If type-VI drones are bought for some of the "slots" on the ADD under (E5.4), a proportional share of the reloads are also type-VI drones unless the owning player voluntarily forgoes this privilege.

**(E5.72) G-RACKS:** Ships firing anti-drones from their type-G drone racks reload them by (FD2.42). Anti-drones are considered 1/2-space items for reloading purposes.

**(E5.73) NO SP or MW:** Anti-drones cannot be placed in a SP shuttle [exception: (FD7.38)] or MW drone. See however (FD15.0).

**(E5.74) RELOADING:** One, two, three, or four anti-drones can be loaded on each ADD rack each turn, but only if the rack is not fired during that turn. This reloading is accomplished automatically if the rack does not fire. If the rack is fired, reloading is cancelled.

Type-VI drones are loaded into an ADD under the provisions of (FD2.42), which requires taking the rack out of service for a complete turn. This is required even if some of the original rounds in the ADD were filled with type-VI drones.

**(E6.0) MONSTER CLOSE-IN DEFENSE SYSTEM (MCIDS)**

Some monsters (see the "SM" scenario section) have a special close-in defense system to protect themselves from drones and other small dangerous targets.

**(E6.1) PROCEDURE AGAINST DRONES**

To resolve the fire of the MCID, roll a single die and find the result on the chart below:

DIE ROLL	EFFECT
1-4	Drone intercepted and destroyed.
5-6	Miss; Drone has not been destroyed or damaged.

**(E6.2) PROCEDURE AGAINST SHUTTLES**

To resolve fire of the MCID against shuttles (including fighters), roll a single die and find the result on the chart below:

DIE ROLL	EFFECT
1-2	Shuttle destroyed.
3-4	Shuttle crippled; a crippled shuttle is destroyed.
5-6	Shuttle undamaged.

Crippling is defined as receiving the number of additional damage points required to cripple the shuttle (J1.33). This applies in the case of an undamaged or a damaged-but-not-crippled shuttle.

**(E6.3) LIMITATIONS**

**(E6.31) FIRING:** The monster close-in defense system can be used up to three times per impulse (at any type or types of acceptable targets) on targets within 3 hexes. The MCIDS cannot fire at a single target more than once per impulse. The MCIDS has an unlimited supply of ammunition.

**(E6.32) RESTRICTIONS:** It is not affected by any other systems or effects, except that it cannot fire through webs, black holes, pulsars, stars, or planets. It can fire through atmospheres and into hexes containing small moons or asteroids. MCIDS is not an aegis system and cannot identify drones.

**(E6.33) REACTION:** If a monster enters a hex containing a shuttle or seeking weapon by reactive movement [e.g., the Moray Eel (SM3.45)], MCIDS will fire on those units immediately, before they can strike the monster. It will do this in every hex it enters during reactive movement. It will not do this during normal movement.

**(E6.4) ALLOCATION**

**(E6.41) PLAYER:** If the monster is operated by a player, he may designate the targets of the three firings per impulse of the MCIDS.

**(E6.42) AUTOMATIC:** If the monster is operated by automatic rules, the three firings per impulse are directed at the "most threatening targets." These are selected in the following order:

1. Seeking weapons that will hit the monster on the next impulse, in order of warhead strength. This includes the warhead strength of drones and suicide shuttles. The monster will know the true warhead strength using its "sixth sense," and will therefore ignore PPTs, slug drones, and dummy shuttles. Player-controlled monsters cannot do this.
2. Fighters within range in order of their direct-firepower output (assuming the best die rolls, the current range, and accounting for which weapons are available to fire).
3. Seeking weapons within range, in the order established by #1 above (SP or MW total warhead strength).

If several targets have equal priority, select one randomly.

**(E6.43) LIMITED TARGETS:** The MCID system cannot be used against any target not specifically listed here. For example, it cannot fire at mines, ships, asteroids, other monsters, or planets.

**(E6.5) PROCEDURE AGAINST PLASMA TORPEDOES**

**(E6.51) PROCEDURE:** The MCIDs system can be used against plasma torpedoes. To resolve this, use the following table:

DIE ROLL	EFFECT
1-2	Warhead reduced by 35 points.
3-4	Warhead reduced by 25 points.
5-6	Warhead reduced by 10 points

**(E6.52) UNACCEPTED TARGETS:** MCIDS ignores pseudo-plasma torpedoes, dummy-seeking shuttles, slug drones, and seeking weapons not targeted on itself. The monster's "sixth sense" can distinguish them. The monster cannot communicate this information to another player except by the act of not firing or by allowing itself to be hit.

**SYNOPSIS OF RULES IN FUTURE PRODUCTS**

To aid in later integration of Basic Set with a whole range of advanced and expansion products, the Basic Set rules are filled with numerous cross-references to the rules from those other products. Of course, if you do not have a given product, then any rules from that product cannot be used; they do not impose any penalties or provide any benefits to the player. To aid in understanding the Basic Set rules, and to prevent confusion over these references to rules in other products, the following synopsis of these rules is provided.

**(E7.0) FUSION BEAMS:** A weapon used by the Hydrans. It has a relatively short range, but is very powerful, particularly when carried by Hydran Stinger fighters. Module C1.

**(E8.0) MAULERS:** Originally developed by the Romulans and later sold to the Klingons and Lyrans. The Mauler fires a narrow beam whenever energy (from huge battery banks) is applied. Advanced Missions.

**(E9.0) TRACTOR-REPULSOR BEAMS:** Used only by the Andromedans, TR beams damage the target by grabbing it with a powerful tractor beam and reversing the polarity rapidly, tearing it to pieces. Module C2.

**(E10.0) HELLBORES:** A long-range weapon used by the Hydrans. Surrounds the target with a ball of energy and then implodes to cause damage to all shields (and extra damage to weak shields). This is found, with the Hydrans, in Module C1.

**(E11.0) PLASMATIC PULSAR DEVICE:** A long-range weapon used by the Interstellar Concordium or ISC. The weapon achieves a carrier-wave lock and then pulses several times with automatic hits. Module C2.

**(E12.0) WEB CASTER:** A Neo-Tholian weapon used to create web at a considerable distance from the ship. Module C2.

**(E13.0) WEB SNARE:** An improvement of the Tholian Web Generator using Neo-Tholian technology. Essentially a Web Caster with a very short range. Module C2.

**(E14.0) WEB FIST:** An alternate use of the Web Caster as a direct-fire weapon directly damaging a target. Module C2.

**(E15.0) WEB BREAKER:** A weapon system that reduces the strength of webs that it is fired at.

**(E16.0) SHIELD CRACKER:** An alternate use of the Web Breaker able to damage shields, but not ships. It also blocks the use of general reinforcement on a down enemy shield, facilitating boarding attacks.

**(E17.0) PARTICLE CANNON:** Direct fire weapon firing twice in a single turn. Used by the Seltorians and the Tholians in their home galaxy, and the Seltorians in our galaxy.

**END OF SECTION (E0.0) BASIC SET**

**(F0.0) SEEKING WEAPONS**

Seeking weapons, unlike the direct-fire weapons in section (E0.0), are represented by a counter on the map and move toward their targets at given speeds. Normally, a seeking weapon will hit (or miss) its target several impulses (or even several turns) after it is launched. The primary characteristic of seeking weapons is that the target ship has an opportunity to outrun, evade, and fire at the weapon.

**(F1.0) TYPES OF SEEKING WEAPONS****(F1.1) TYPES**

There are two types of seeking weapons: drones (similar to radar-homing missiles) and plasma torpedoes (charged balls of energy). Because this rules section currently describes only two weapons, and because those weapons are very complicated devices to explain, it is organized somewhat differently than most other sections. A two-letter superscript (FD) is used on rules concerning drones, while a different superscript (FP) is used on rules concerning plasma torpedoes. The one-letter superscript "F" is used on rules that apply to both types.

It is possible that a third type of seeking weapon might be added to the game in a future product. In that event, a unique superscript will be assigned to it.

Some "other units" use some aspects of the seeking weapon rules. These other units are specified in their rules; players cannot use the seeking rules for units of their choice unless so allowed by the rules. Some of the units which use some aspects of the seeking weapon rules are suicide freighters (R1.33), ships using pursuit plotting (C1.322), and certain monsters. Suicide shuttles and scatter-packs, except where noted, use the "drone" rules.

**(F1.2) LAUNCH SEQUENCE**

**(F1.21) CADET'S GAME:** In the Cadet's Game, drones and seeking shuttles are launched at the start of the turn in the Drone and Shuttlecraft Launch Phase. Plasma torpedoes are launched at the end of the turn in the Plasma Torpedo Launch Phase. These weapons will be removed from play during the Final Activity Phase of the last turn of their endurance (excepting the short-ranged dogfight drones, which would be removed at the end of their 12-hex range). The endurance of plasma torpedoes is one turn, although all but the most powerful will have no effect during the later portions of that turn and should be removed (once their damage rating reaches zero) to avoid cluttering the board.

**(F1.22) STANDARD GAME:** In the Standard Game, either (or both) may be launched during the Seeking Weapons Stage of any impulse. Seeking weapons are NOT launched during the Initial or Final Activity Phases in the Standard Game.

**(F1.221)** In a given impulse, all seeking weapons of a given type are launched simultaneously. See segment 6B6 for the order in which different types are launched. This may require written orders (B2.4) in complex situations.

**(F1.222)** Shuttles used as seeking weapons are launched when other shuttles are launched, not when seeking weapons are launched, as otherwise this would give away their identity.

**(F1.23) LAUNCH TUBE OR RACK:** The specific launch tube or rack of a drone or plasma torpedo need not be disclosed except by Tactical Intelligence (D17.0) or when the launching ship is within 20 hexes (and the launcher has the observing ship within its firing arc). A player does not have to verbally announce which mount launched a drone or plasma, but must provide the required information if asked, even if asked after the weapon was launched. This rule takes precedence over (D17.91).

**(F1.24) TARGET:** The target of a seeking weapon must be in that seeking weapon's FA arc when the weapon is placed on the board. See (FD1.21) and (FP3.0). See also (FP1.312).

**(F1.3) X-SHIP SEEKING WEAPONS**

The game of Star Fleet Battles is primarily focused on the historical period of Y150-Y185. Near the end of this period certain advanced ships (known as X-ships because of their experimental technology) were introduced. After Y205 a second generation of X-ships (known as X2-ships) appeared and the original X-ships became known as X1 ships.

These X-ships use advanced forms of drones and plasma torpedoes. These weapons are mentioned occasionally in the FD and FP sections for future reference.

*THESE REFERENCES CAN BE IGNORED BY THOSE PLAYERS WHO DO NOT HAVE CAPTAIN'S MODULE X1 OR WHO ARE NOT USING X-SHIPS.*

Section (X0.0) in Captain's Module X1 includes many exceptions and changes to the drone and plasma rules, not all of which are mentioned within sections F, FD, or FP.

First Generation (X1, Y180-Y205 X-ships are presented in Captain's Module X1. Second Generation (X2, Y205-224) X-ships will be presented in Captain's Module X2.

**(F1.4) IDENTIFICATION OF SEEKING WEAPONS**

There are various means by which information about enemy seeking weapons can be obtained. These include:

Labs (G4.23): this rule contains the comprehensive list of information that can be obtained.

Aegis (D13.34) provides the same information as labs.

Scout sensors (G24.25) obtain the same information as labs.

SWAC shuttles (J9.12) have scout capabilities.

It is of course possible to deduce certain information from the basic behavior of the seeking weapon.

**(F2.0) SEEKING WEAPON MOVEMENT**

Seeking weapons move and follow their targets within the following rules.

**(F2.1) MOVEMENT AND MANEUVER**

**(F2.11) SPEED:** Seeking weapons move with a fixed practical speed.  
**(F2.111)** Plasma torpedoes move at a speed of 32. Plasma torpedoes cannot be crippled, and their speed is not reduced due to damage inflicted on them.  
**(F2.112)** Drones move at a speed based on their type; see (FD2.1). Drones cannot be crippled, and their speed is not reduced due to damage inflicted on them.  
**(F2.113)** Shuttles used as seeking weapons move at any speed set by the owning player up to their maximum rated speed (as modified by booster packs or crippled status). This speed cannot be changed after the shuttle is launched.  
**(F2.114)** Other units, such as suicide freighters (R1.33), used as seeking weapons move at the speed specified in their specific rules.

**(F2.12) TURN MODE:** The turn modes of seeking weapons are as follows:

**(F2.121)** Drones and plasma torpedoes have a turn mode of 1 at all speeds.  
**(F2.122)** Shuttles used as seeking weapons have their original turn mode (J1.23). Suicide freighters (R1.33) also have their original turn mode.  
**(F2.123)** All seeking weapons must move directly forward on their first impulse of movement after launch unless they use their HET (F2.135).

**(F2.13) HIGH ENERGY TURNS:** All drones and plasma torpedoes may make one high energy turn during each period of 32 consecutive impulses on the map. Fighters used as scatter-packs (FD7.44) can make HETs (J4.12); non-fighter shuttles cannot.

**(F2.131)** When making an HET, the weapon does not move, but simply turns in place. The HET costs nothing (other than the lost movement) and cannot cause a breakdown. If a seeking weapon HETs, its next subsequent move must be straight-forward; it cannot turn or sideslip on that move.

**(F2.132)** The option to use an HET is up to the player owning the weapon; it can never be forced to make one, even if using an HET is the only way to satisfy (F2.2). Conversely, a seeking weapon cannot make an HET if it could move closer to the target under (F2.2). The weapon must complete the HET with the target in its FA arc. A seeking weapon which does not move on the current impulse, but which could enter the current hex of the target on its next movement, cannot use an HET to avoid this movement (F2.21-1). An HET may not be made if it is not necessary to enable the seeking weapon to track its target under (F2.2).

**(F2.133)** As the HET counts as the movement for that impulse, it counts against the endurance of a plasma torpedo or drone (as one hex).

**(F2.134)** Other units (shuttles, monsters, etc.) may use an HET under the normal rules for that type of unit, assuming that such a unit (in its present condition) is normally allowed to make HETs.

**(F2.135)** Seeking weapons cannot use their HET during the impulse of launch but can use it during the impulse after launch (which is the first movement impulse for the weapon). A seeking weapon could make an HET during Impulse #1.

**(F2.136)** A seeking weapon could make an HET on an impulse when it is not scheduled to move; the weapon would then skip its next scheduled movement.

**(F2.14) REVERSE:** Seeking weapons cannot move in reverse (C3.5); they can only move forward. See also (J1.24).

**(F2.2) SEEKING MOVEMENT**

Seeking weapons "home in" on their targets. Seeking weapons move when called for by the movement chart. The owning player may move the seeking weapon in any manner within the limits of the rules and the following conditions:

**(F2.21) BASIC CONDITIONS:** The basic seeking weapon conditions are:

1. If it is possible to move the seeking weapon closer to its target, this must be done.
2. If #1 is impossible, the seeking weapon must, if possible, move in such a manner as to maintain the current distance from the target.

All distances are based on the distance at the instant before the seeking weapon moves (C1.313). The seeking weapon cannot be forced to use its HET; see (F2.132).

**(F2.22) TRACKING ARC:** Having satisfied the above conditions, the seeking weapon must move in such a way to place or keep the target in the weapon's FA firing arc. If this is not possible, the seeking weapon must move in such a way as to place or keep the target in the weapon's FX firing arc. If this is not possible, this condition is ignored. Note that ship-guided weapons are unaffected by an out-of-arc target, while certain self-guided weapons must have the target in their FA arc or they become inert (FD1.7) and cease to function.

**(F2.23) REQUIRED MANEUVERS:** A moving seeking weapon must turn or sideslip to satisfy the above conditions. A seeking weapon is not required to use an HET (F2.132) to satisfy the above conditions.

**(F2.24) MOVING TARGET:** If a seeking weapon and its target are moving on the same impulse, the seeking weapon homes in on the hex the target is entering, not the one it is leaving. If the target enters the seeking weapon's hex, the seeking weapon does not move but is assumed to have hit the target; see (F2.31). See also (F2.5).

Note that because of the Order of Precedence (C1.313), the target will almost always have moved before the seeking weapon does if both are scheduled to move on that impulse. See special instructions in step 5 if one seeking weapon is targeted on another.

**(F2.3) SEEKING WEAPON IMPACT**

Generally, seeking weapons strike their targets upon entering the target's hex. See (G10.521) if the target is in web.

**(F2.31) GENERAL PROCEDURE:** Seeking weapons impact upon entering the hex of their target, or upon their target entering the hex occupied by the seeking weapon. See (F2.32) if the seeking weapon was launched in the same hex as its target.

**(F2.311)** The effect of this impact generally produces an explosion, which is resolved in the Resolve Damage From Seeking Weapons (or the Resolve Damage From Enveloping Plasma Torpedoes) Step of the turn. The impact of the seeking weapon destroys the seeking weapon.

**(F2.312)** Several types of "movement" (black hole, nebula, seeking weapon, rotation, target) could result in the target and the seeking weapon coexisting in the same hex, resulting in impact. The impact from all these forms of movement is resolved in the steps noted in (F2.311).

**(F2.313)** As a seeking weapon impacts upon entering the target's hex, the target will not have the opportunity to fire on that seeking weapon at a range of "0." Note that if a seeking weapon targeted on one unit passes through the hex occupied by another unit, the unit being "passed" could fire at it at a range of "0" since the seeking weapon did not impact when entering that hex (since it hasn't reached its target). See (F2.32) if the seeking weapon was launched in the same hex as its target.

**(F2.314)** Even if the seeking weapon is held in a tractor beam (an enemy tractor, as a friendly tractor would cause it to go inert), if impact conditions exist, the weapon will impact. If a drone is held in a tractor and rotated (by any unfriendly unit) into the hex of the targeted unit, it impacts immediately.

**(F2.32) SAME HEX LAUNCH:** If the seeking weapon is launched in the same hex as its target, the Sequence of Play allows the target the opportunity to fire at the seeking weapon (assuming other conditions, such as having a charged weapon available, are met). In abbreviated form (where N is the impulse of launch), these are:

- Impulse #N: Seeking Weapon Movement (ignored since the seeking weapon in question has not been launched yet).  
 Seeking Weapon Launch (the seeking weapon is launched in the same hex as the target).  
 Direct-Fire Weapons (the target and/or other units fire at the seeking weapon).
- Impulse #N+1: Movement (for this example, the target is not scheduled to move on Impulse #N+1).  
 Seeking Weapon Movement (the seeking weapon impacts on the target, regardless of whether or not the seeking weapon is scheduled to "move" on that impulse by the impulse chart).

**(F2.321)** Since seeking weapon launch comes in the Impulse Activity Segment (after the Movement Segment and before Direct-Fire Weapons), the target unit (and/or other units) will have the opportunity to fire direct-fire weapons at the seeking weapon before it can impact. Which weapons are eligible to fire at the seeking weapon is determined by finding the direction to the unit that launched the seeking weapon. See (D3.42) for the facing shield.

**(F2.322)** If the target moves out of the hex during the impulse after launch, the seeking weapon will follow the target as per the normal rules.

**(F2.323)** For purposes of same hex launch (and same hex impact), the shield hit by the seeking weapon (regardless of its direction of launch) is the shield facing the unit that launched the seeking weapon (D3.42) at the moment of launch.

**(F2.3231)** Under (C1.313) the target may have made an HET or tactical maneuver and changed the facing shield.

**(F2.3232)** Because the target must be in the seeking weapon's FA arc (F1.24), if an enemy unit is making a high speed run through your hex, you would be obligated to face seeking weapons launched while he was in the hex toward him (opposite his direction of movement); the weapons would then be left facing the wrong direction if he moved out of the hex on the next impulse. It would be more advisable to launch the weapons before he entered your hex or just after he left it.

**(F2.33) TARGETS:** Each seeking weapon has one target, which is assigned at launch.

**(F2.331)** The owning player cannot change the target of a seeking weapon after launch.

**(F2.332)** There are various methods by which a seeking weapon may be made to change involuntarily to a different target. These include:

Wild Weasels (J3.2), and voided WWs (J3.4).

Wild SWAC shuttles (J9.24).

Wild Scout PFs (K1.756).

Special Sensors (G24.23).

Planets (P2.33).

Docking (F2.335) and (C13.943).

Dogfights (J7.32).

Ballistic drones or other units dragged off course (F4.5).

Wild Boar drones (FD5.255) use a series of targets and follow each in sequence, but this is not a voluntary change of target as it is programmed before launch.

**(F2.333)** Even if more than one unit is in the same hex as the target, only the target is damaged by a seeking weapon. Exceptions: collateral damage (J3.3), docked ships (C13.943).

**(F2.334)** A seeking weapon which passes through hexes containing other (enemy, friendly, and neutral) units which are not the target of that seeking weapon does not damage those other units. Accidental collisions are so unlikely as to be considered impossible.

**(F2.335)** If a target being tracked by seeking weapons docks inside or to a larger unit, the seeking weapon will accept this larger unit as its target. If two equal units dock (C13.943), the weapon will damage both.

**(F2.336)** If a unit undocks or launches from a unit that is the target of a seeking weapon, the seeking weapon will remain locked onto its original (larger) target. This applies to SP and MW also. Exceptions: Wild weasels (J3.0), SWACS (J9.24), random selection of one target when two ships undock (C13.943), pinwheel separation (C14.36).

## (F2.4) NON-IMPACT WEAPONS

Some seeking weapons, primarily certain types of drones, do not impact on their targets when they enter the same hex.

**(F2.41) DRONES:** Certain types of drones do not impact on their target. Note that any of these drones will interact with an ESG field (G23.0) as if it were an armed drone.

**(F2.411) ECM (FD9.0)** adopt station-keeping (C1.3224) on their targets. ECM drones escorting other drones DO impact the target of the drones, but unless they have an explosive module on board, they will do no damage to it, even if the target is another drone (FD1.562) or a shuttle.

**(F2.412)** Swordfish drones (FD11.0) stop at some distance from the target and fire a phaser at it. Two-space Swordfish drones equipped with phaser-3 modules do continue on and impact their target after firing their phaser, but will only cause damage if there is an explosive module aboard. Swordfish drones equipped with phaser-2 modules burn up completely when the phaser is fired.

**(F2.413)** Probe drones (FD6.0) do not impact on their target.

**(F2.414)** The empty bus vehicle of a multi-warhead drone (FD8.0) will not cause damage if it impacts a target. Scatter-pack shuttles will not impact on their target (before or after releasing weapons); see (FD7.333).

**(F2.42) PLASMA TORPEDOES:** Pseudo-plasma torpedoes (FP6.0) do not damage their targets, but do "impact." See (FP6.31).

**(F2.43) PREVENTING IMPACT:** A seeking weapon might be prevented from impacting on its intended target by several means:

**(F2.431)** The seeking weapon could be destroyed by a direct-fire weapon (FD1.5) or (FP1.6), another seeking weapon (FD1.56), or a mine (M1.0).

**(F2.432)** Web (G10.0) could stop its movement. This includes cast web (E12.0) and snares (E13.0).

**(F2.433)** Terrain (P0.0) could damage and even destroy the weapon, or the weapon could accept a planet as its target (P.233).

**(F2.434)** Tractor beams (G7.0) could grab the weapon (although not a plasma torpedo) and hold it.

**(F2.435)** A stasis field generator could freeze the seeking weapon or hold the target in a stasis field (G16.41), preventing damage to the target.

**(F2.436)** Guidance could be dropped (F3.4), the guiding unit could lose lock-on to the target (various means), the target could disengage (C7.0), or the weapon could exhaust its endurance. See (C7.22) in the case of self-guiding seeking weapons which have their own lock-ons to a disengaging ship.

**(F2.437)** Scout sensors could cause the weapon to lose its tracking (G24.22).

**(F2.438)** Those cases that could cause an involuntary change of targets (F2.332) will change the target that the weapon will impact but will not prevent it from impacting its then-current target.

**(F2.439)** Other possible defenses include WWs, scouts attracting or breaking lock-on of drones, Wild SWACS or PFSs.

## (F2.5) MUTUAL IMPACT

In the case of one seeking weapon targeted on another†, the following example defines the procedure. Drone A is targeted on ship B; plasma C is targeted on drone A.

**(F2.51)** If drone A enters a hex that contains plasma C but not ship B, or if plasma C enters a hex that contains drone A but not ship B, plasma C destroys drone A and is, itself, destroyed in the process.

**(F2.52)** If drone A enters a hex that contains ship B but not plasma C, drone A hits ship B, and plasma C, having nothing to track, becomes inert.

**(F2.53)** If drone A enters a hex that contains both ship B and plasma C, plasma C destroys drone A before drone A can hit ship B.

**(F2.54)** If drone A and plasma C both enter ship B's hex on the same impulse, the faster seeking weapon will hit its target first. If both seeking weapons are the same speed, BOTH will hit ship B. (If both weapons hit the ship, they strike the same shield.)

† This will mean two drones or seeking shuttles targeted on each other (or a plasma targeted on a drone) because plasma torpedoes cannot be targeted on each other, and the only drone that can be fired at a plasma torpedo (Swordfish) will fire its phaser during

the Direct-Fire Segment of the impulse. Various combinations of ship, plasma, and drone are possible in the above example.

See (FD1.56) as some drones will not destroy another drone on impact. Note that for purposes of this example it is assumed the plasma torpedo's warhead was still powerful enough to kill the drone at the point of impact.

### (F2.6) CONTINUOUS TRACKING

So long as one enemy ship has a lock-on to a seeking weapon, that seeking weapon is known as a unique individual (within a group of seeking weapons) from launch until impact.

**(F2.61) MULTIPLE WEAPONS:** If several seeking weapons are in the same hex, the opposing players (having satisfied the above condition) will know which one is the one launched by ship X on Impulse #Y, or which drones are the submunitions from the MW drone launched by ship A which separated on Impulse #B in hex C.

**(F2.62) LIMIT OF INFORMATION:** While this rule allows seeking weapons to be tracked as individual entities, it provides no other information. Data such as drone type is learned by various means (F1.4) and is associated with the identity.

**(F2.63) LOST LOCK-ON:** If lock-on is lost to several seeking weapons and then restored, the opposing players will not know which seeking weapon is which in so far as when and by what ship it was launched, but they will be able to track seeking weapon identities from the point at which a lock-on was re-established.

**(F2.64) SHARED INFORMATION:** This information is shared by all units on one side. If there are two or more sides, each side records this data separately and may, but is not required to, share it with other sides.

**(F2.65) PLASMA TORPEDOES:** The warhead strength of a plasma torpedo is known continuously (FP1.323), but a torpedo is known as a unique individual only by (F2.6). If lock-on is lost temporarily (F2.63), the opposing player could determine that three torpedoes were all at strength 15, but could not tell which was the type-F that had traveled 7 hexes, which was the type-G that had traveled 11 hexes, and which was the type-S that had traveled 19 hexes.

**(F2.66) PASSIVE FIRE CONTROL:** A ship under PFC (D19.0), including a cloaked ship, can retain tracking of individual seeking weapons within 5 hexes.

## (F3.0) SEEKING WEAPON GUIDANCE

### (F3.1) CONTROL

A unit launches one or more seeking weapons, designates their targets, and "controls" the weapons in route. It is important to understand what "control" entails.

The term "control" does not mean that the player may move the weapon wherever he wishes; movement must be within the limits of (F2.0). Nor does "control" mean that the target can be selected or changed after launch; see (F2.331).

Control means that the controlling (or guiding) unit is focusing its fire control systems on the target and providing the moving seeking weapon with continual updates on the target's location. This guidance may include electronic warfare support; see (F3.331). Many seeking weapons cannot function without being guided; see (F3.41).

### (F3.2) CONTROL RATING

Each unit has a specified number of "control channels" to be used in guiding seeking weapons. Each channel can control one weapon at a time.

**(F3.21) SHIPS** (with certain exceptions below) can control a number of seeking weapons (drones, plasma torpedoes, pseudo-plasma torpedoes, scatter-packs, suicide shuttles) equal to their sensor rating at any given time (usually 6). This procedure operates as defined in (F3.3). All seeking weapons are treated equally; a Klingon D7 battlecruiser could simultaneously control two of its own drones, three plasma torpedoes fired by allied Romulan ships, and a suicide shuttle launched by an allied Lyran ship. See (G14.111)

**(F3.211)** Those ships (even those from seeking weapon races) not armed with drones or plasma torpedoes can control weapons equal to one-half of their sensor rating (usually 3), round fractions of 0.5 up. Anti-drone racks do not count as drone racks for this purpose.

**(F3.212)** Some ships are noted in their descriptions as able to control seeking weapons equal to double their sensor ratings. For example, the Kzinti CV (R5.6) has this capability. This is often described as "double drone control," but in fact any and all seeking weapons can be controlled.

**(F3.213)** Scouts can use a sensor channel to control additional seeking weapons. A scout with inherent double control capabilities under (F3.212) could, by using a scout channel (G24.24), control 18 seeking weapons. No ship in Basic Set has this capability.

**(F3.214)** PFs (K1.0), bases of all types, and Interceptors (K3.0) are treated as ships. See (R0.6).

**(F3.215)** Damage to the sensor track takes effect at the end of the turn (for purposes of control rating). See (D6.132) and (D6.11).

**(F3.216)** The PPD (E11.15) is a direct-fire weapon used by the ISC. Firing it requires a seeking weapon control channel. Note that only the ship firing the PPD can provide the control channel (E11.151).

**(F3.22) FIGHTERS AND SHUTTLES:** Fighters can control their own seeking weapons (i.e., those they launched) or transfer (F3.5) this control to another unit. The launch and control rates of fighters may differ; see also (J4.24) and (J4.25).

**(F3.221)** Fighters can control (and transfer control of) their type-VI drones. These can be released to guide themselves.

**(F3.222)** A two-seat fighter (including an EWF) (J4.43) can control up to 12 seeking weapons launched by other fighters of its own squadron (J4.46), but no other fighter can control weapons that it did not launch. [Exception: (J10.44).] MRS shuttles can control six seeking weapons (J8.34). The control of seeking weapons does not diminish the EW capabilities of an MRS or EWF.

**(F3.223)** SWACS (J9.12) use one (not both) of their scout channels to control seeking weapons.

**(F3.224)** Administrative, minesweeping, heavy transport, ground assault, and other non-combat shuttles cannot control seeking weapons.

**(F3.225)** Scatter-packs (FD7.0), including those based on an MRS or fighter, cannot control their own or any other seeking weapons.

**(F3.226)** Captor mines (M4.425) and defense satellites (R1.15) are treated as fighters. They can control seeking weapons they launch, but cannot accept control of a seeking weapon from another unit.

**(F3.3) CONTROL REQUIREMENTS**

**(F3.31) CONDITIONS:** To control seeking weapons, a unit must meet all of the following qualifications:

1. The unit must have active fire control operating.
2. The unit must have a lock-on to the target.
3. The unit must be within 35 hexes of the target.
4. The unit must be within 35 hexes of the weapon.
5. The weapon must be within 35 hexes of the target.
6. The unit must have an adequate number of control channels (F3.2).

All of the ranges are effective range (D1.4).

**(F3.32) LOSS OF QUALIFICATIONS:** If at any point the controlling unit fails to meet or maintain the conditions in (F3.31), the seeking weapons it controls are released (F3.4) and may become inert (FD1.7) if control cannot be transferred (F3.5) or assumed by the weapon itself (F3.42).

**(F3.33) EFFECT OF CONTROL:** A unit with control of a seeking weapon has the following capabilities:

**(F3.331) ELECTRONIC WARFARE:** The seeking weapon has the ECCM of the controlling unit (including any ECCM lent to that guiding unit), in addition to its own ECCM if any. Thus, a weapon could have 12 ECCM points from the guiding unit plus (perhaps) up to 3 points of its own ECCM. Legendary officers and outstanding crews may add more ECCM. The ECCM strength of a seeking weapon is revealed on impact; some indications will be known beforehand due to the identity of the controlling unit and (perhaps) identification of the weapon.

**(F3.332) TRANSFER:** The weapon can be transferred to the control of another unit; see (F3.5).

**(F3.333) RELEASE:** The seeking weapon can be released to its own control; see (F3.42).

**(F3.334) LIMITATIONS:** The controlling unit cannot change the target of the seeking weapon (F2.331). The seeking weapon must be moved within the limitations of the rules; see (F2.2).

**(F3.34) IDENTITY OF CONTROLLER:** All players will always know which unit is controlling any given seeking weapon. The controller of a seeking shuttle is never identified until the seeking shuttle is itself identified by the (G4.2) Lab procedure, (G24.25) Special Sensors procedure, or the (G5.25) Probe procedure. Add to end "...and except Death-Rider PFs (K7.11)."

**(F3.341)** All transfers (F3.5) and releases (F3.4) must be announced, and any weapon providing its own guidance must be so designated. Any player can ask the owner of any seeking weapon (except a seeking shuttle) at any time which unit is controlling it.

**(F3.342)** Ballistic weapons are reported as self-guiding (unless the owner is using a control channel to guide the ballistic weapon to avoid revealing its ballistic nature).

**(F3.343)** A weapon capable of self-guidance which has not been released will not be reported as being "capable of" self-guidance.

**(F3.4) RELEASE OF CONTROL**

Units controlling seeking weapons may release control of those weapons. This may be done voluntarily, or may be required by certain conditions (F3.53). Once control is released (and assuming it is not transferred to another unit), it cannot be regained by any means.

**(F3.41) EFFECT OF RELEASE:** When control is released, another friendly unit can assume control of that seeking weapon (F3.5). If no other unit assumes control, the seeking weapon will become inert (FD1.7) unless it is capable of controlling itself. Control is released in the Seeking Weapon Stage of the Impulse Activity Segment. Release is always announced (F3.34).

**(F3.42) SELF-GUIDING WEAPONS:** Plasma torpedoes (FP4.0), drones with active terminal guidance (FD5.2), and type-VI drones (FD5.1) are capable of guiding themselves if released from control by the controlling unit. This rule does NOT imply that it is possible to regain control of a seeking weapon that was released; see (F3.4).

**(F3.421)** A seeking weapon capable of self-guiding is assumed to be under the control of a guiding unit until control over it has been released (F3.4). Once control over a self-guiding seeking weapon is released [without it being transferred to another unit (F3.5)], the

seeking weapon controls itself. No other unit may subsequently assume control over it. This rule states that no OTHER unit can gain control. This does NOT imply that the original owner can regain control; the basic rule (F3.4) already prohibits that.

**(F3.422)** In order for a self-guiding weapon to maintain tracking on its target, it is required to have a lock-on (D6.11) to that target and to be within tracking range of the target. Depending on the type of weapon, it may be required to keep its target in a specified arc as well; see (F2.2). For lock-on purposes, a self-guiding seeking weapon has a sensor rating of 6 (which can never be reduced). The maximum tracking range of a self-guided seeking weapon is 35 hexes, unless superseded in the specific rules for that weapon.

**(F3.423)** A seeking weapon with its own guidance cannot be commanded to go inert (FD1.7); if released, it will automatically assume its own guidance.

**(F3.424)** If the target cloaks, a self-guiding seeking weapon will attempt to retain its own lock-on. See (FP4.5) and (FD5.24). See (G13.334) for the retention rule; self-guiding seeking weapons have a sensor rating of 6.

**(F3.425)** Self-guiding seeking weapons may be tricked into accepting a planetary body as their target; see (P2.33).

**(F3.5) TRANSFER OF CONTROL**

Control of seeking weapons can be transferred between various units. Transferring control of a self-guiding seeking weapon to itself is automatic upon release (F3.4).

**(F3.51) PROCEDURE:** The unit controlling the seeking weapon must release that control (F3.4). The unit assuming control then does so at the same point (there is no "uncontrolled period"). Voluntary transfers are done in the Seeking Weapon Stage 6B6; involuntary transfers occur at various points. Transfer is always announced (F3.34). Units with all control channels in use could exchange control of seeking weapons if all other conditions are met.

**(F3.52) REQUIREMENTS:** The unit assuming control must be friendly to the unit releasing control and have the permission of the releasing unit to assume control. The unit assuming control must satisfy the requirements to control the seeking weapon; see (F3.3). The unit assuming control must have an available control channel; see (F3.2). The unit releasing control and the unit assuming control must be within 35 hexes of each other (and the weapon).

**(F3.53) SEQUENCE:** The transfer of control of a seeking weapon can be done voluntarily or involuntarily.

**(F3.531)** Voluntary transfer of control takes place during the Seeking Weapons Stage of the Impulse Activity Segment. It cannot take place on the impulse in which the seeking weapon itself was launched because of the order of procedures in the Sequence of Play, so a self-guiding seeking weapon would use a control channel during its first impulse.

**(F3.532)** Involuntary transfer takes place at any point in the turn in which the controlling unit must release control (F3.4). This includes:

Destruction of the controlling unit.

Any event which disqualifies the controlling unit under (F3.3).

The controlling unit is placed in stasis (G16.0)

The unit receiving control does so immediately.

**(F3.54) CLOAKED TARGET:** Control of a weapon targeted on a cloaked unit cannot be transferred due to the weak target signature.

**(F3.6) SECRET TARGETING (ADVANCED)**

When a seeking weapon is launched, the owning player is not required to reveal the target of the weapon. He must, however, record the target in writing (on an index card, a piece of scratch paper, or a play aid form found in Module R1) and place this record face down on the table. (Players may develop their own alternatives for this procedure. The point is that both players must be satisfied that the record has not been changed after launch.) The record is revealed when the weapon reaches the target or when the weapon is identified by (F1.4). It is sometimes possible to deduce the target of a seeking weapon by its actions.

**(F4.0) BALLISTIC TARGETING**

Under certain conditions, a seeking weapon can be set on a ballistic course. That is, it is not aimed at a target unit but in a specific direction or at a specific (vacant) point in space.

Ballistic weapons can be used against ground targets; see (F4.22). See (D19.22) for use by ships using passive fire control.

**(F4.1) DESIGNATION**

**(F4.11) PROCEDURE:** To establish a ballistic course, designate a hex, not a unit, as the target of the seeking weapon. The seeking weapon will "pursue" this hex by the most nearly direct route. Upon reaching the target hex, the seeking weapon will "evade" that hex, adhering as nearly as possible to a course directly opposite its approach course. If the ballistic unit enters a third hex adjacent to the target hex without having entered the target hex, it will begin "evading" the target hex from that point.

**(F4.12) CONTROL:** Seeking weapons on a ballistic course are released from control immediately on launch and never count against the control limit of the launching unit.

There is a partial exception in that the submunitions of a ballistic scatter-pack must be guided. The controlling unit will have to provide this guidance at the release point or the submunitions will become inert (FD1.7).

See (F4.3) for type-IIIIX drones, including MW.

**(F4.13) SINGLE TARGET:** A seeking weapon on a ballistic course can only have one target hex, not several to be executed sequentially.

Multiple-point targeting is a function of the extremely long-range type-IIIIX drones (FD5.25); this is never under player control, but is used to account for drones entering a scenario.

**(F4.14) RANGE:** Seeking weapons fired on a ballistic course have the same range as seeking weapons fired normally. Exception: (P2.713).

**(F4.2) DETONATION**

**(F4.21) NO EXPLOSION:** Exploding seeking weapons (drones, plasma torpedoes, suicide shuttles) can be fired on a ballistic course but will normally never explode. The only purpose for this would be to detect a minefield, clear a path through asteroids, saturate defenses, or deceive an opponent. Exceptions are listed below and in (F4.3) and (F4.4).

**(F4.22) GROUND TARGETS:** A seeking weapon fired at targets on a planet will explode against that target if it satisfies (P2.713).

**(F4.23) SUICIDE SHUTTLES:** The anti-tamper devices on suicide shuttles (J2.228) can cause them to explode if another unit attempts to recover them.

**(F4.3) TYPE-III DRONES**

Type-III drones fired on a ballistic course can be set to accept targets within certain conditions. See (FD5.25). Standard ATG drones do not have this ability.

**(F4.4) SCATTER-PACK SHUTTLES**

**(F4.41) PROCEDURE:** Scatter-pack shuttles set on a ballistic course will release their submunitions when the first acceptable target (based on their instructions) is within their pre-set release range. The acceptability of targets is set as in (FD7.3).

**(F4.411)** A cloaked target is not "an acceptable target" unless the SP (or the ship controlling it) has a lock-on to the cloaked target.

**(F4.412)** Seeking weapons on ballistic trajectories can never hit ships or bases in space.

**(F4.413)** While a scatter-pack can be targeted on a hex, that hex cannot provoke release of the submunitions. Only a valid target can trigger this release.

**(F4.42) GUIDANCE** for the submunitions must be provided by another unit immediately upon release as the SP itself cannot guide them. [Exception: (FD7.37), which also applies to MW drones.]

**(F4.421)** Once the submunitions are released (i.e., launched), the unit controlling them can release or transfer guidance normally.

**(F4.422)** As only the "controlling unit" of the SP can designate targets for its submunition, some unit must have control of the ballistic SP. If the unit which launched the SP did not (or could not) retain control, any friendly ship (not shuttle or PF) can gain control of the SP at the time of release. (This requires a secure communications system, a permissive action link with limited retry capability, a code combination several thousand digits long, and other safeguards which your crew will take care of for you.) The unit controlling the SP cannot maneuver the SP beyond the limits of (F4.11). See (FD7.363) for the number of channels required at the instant of release.

**(F4.43) COURSE:** A ballistic scatter-pack can be ordered to go to its target hex and stop, rather than continuing on. This must be programmed into the instructions at the time of launch. As with all scatter-packs, a ballistic scatter-pack can be set for any speed from zero to its maximum.

**(F4.5) TRACTORS**

If held in a tractor beam, a ballistic drone or shuttle will be treated for movement purposes under (G7.52) but as a unit with zero movement cost and zero movement energy (i.e., it will move with the ship holding it.). If released, it will resume its original direction. If targeted on a hex, the target hex will be offset by the distance and direction from where the drone was tractored to where it was released.

A ballistic seeking weapon (including SP and MW) which is tractored by a friendly unit becomes inert.

**END OF SECTION (F0.0) BASIC SET**



**(FD0.0) DRONES****(FD1.0) GENERAL RULES**

Drones are small unmanned missiles with a trans-light speed capability. Prior to the General War, Klingon ships carried these devices as auxiliary weapons and Kzinti ships carried them as their primary armament.

As the General War began, the Federation had adopted drones as an auxiliary weapon and the Kzintis had refitted their ships with more direct-fire weapons, making drones co-equal with disruptors and phasers in their service. Advances in drone technology (speed increases and new types of warheads and guidance systems) make drones far more dangerous.

Drones are very similar to 20th Century radar-homing missiles. They are launched by a starship (or fighter) which has a sensor lock-on to another ship (or other target) and then home in on that target.

**(FD1.1) DRONE LAUNCHERS**

Drones are carried in the drone racks of ships and on the launch rails of fighters. Drone racks are of various types and sizes (FD3.0), although the most common type (type-A) holds four drones and can fire one per turn. Fighters (and some shuttles) carry drones on their launch rails; see (J4.0).

**(FD1.2) LAUNCHING DRONES**

Drones can be launched (or fired) during the Seeking Weapons Stage 6B6 of the Impulse Activity Segment of each turn.

**(FD1.21) PROCEDURE:** When launched, the drone is placed on top of the launching ship, facing any direction at the option of the owning player. Drones must have their target in their FA arc when launched. The target ship for each drone must be announced on launch; exception (F3.6).

**(FD1.22) ENERGY:** It requires no energy to launch a drone, although fire control must be active. Exception (D19.22) launch under passive fire control.

**(FD1.23) SPEED:** Drone speed is determined by the drone type. Drones cannot be set to run at a lower speed than that listed in (FD2.1). The mass-produced engines are designed to run at a specific speed for a specific period of time.

Exception: ECM drones (FD9.11) adjust their own speed automatically.

**(FD1.24) RECORDS:** A record must be kept of the drones remaining in each launching rack. Space is provided on the SSD for this purpose.

**(FD1.3) DRONE TARGETS**

A drone may be targeted on anything (including another drone or a fighter) except a plasma torpedo.

Exception: Swordfish drones (FD11.0) can be targeted on a plasma torpedo.

Exception: Most friendly units cannot be targeted (D1.5).

**(FD1.4) DRONE RANGE AND ENDURANCE**

All drones are assigned an endurance expressed in turns. If the drone has not been destroyed or hit its target when this endurance is exhausted, it is treated as an expended drone (FD1.7). Note that if a drone is fired during a given impulse of a turn, it will reach the end of its endurance during the same impulse of a later turn.

**(FD1.5) FIRING AT DRONES**

Any type of weapon can be fired at drones, but some (because of their nature) are penalized when doing so.

**(FD1.51) UNPENALIZED WEAPONS:** Phasers (E2.0), plasma torpedoes (FP0.0), drones (FD0.0), displacement devices (G18.0), stasis field generators (G16.0), anti-drones (E5.0), Web Fist (E14.215), and maulers (E8.0) all fire at drones without penalty.

Web casters (E12.0) and snares (E13.0) do not actually fire "at" drones, but place web in front of them. They are not penalized if the intended victim is a drone.

**(FD1.52) PENALIZED WEAPONS:** Photon torpedoes (E4.0), disruptors (E3.0), TR beams (E9.0), hellbores (E10.0), fusion beams (E7.0), plasma bolts (FP8.0), particle cannons (E17.54), and plasmatic pulsar devices (E11.0), are all penalized by four points of ECM when firing at drones. These ECM points are treated as "natural sources" (D6.3143).

**(FD1.53) EXPANDING SPHERE GENERATORS** have a lethal effect on drones (G23.0).

**(FD1.54) DESTRUCTION:** A drone is destroyed if it receives damage points equal to its destruction rating (FD2.1). There are no "crippled drones." The number of damage points required to destroy a drone may be modified by armor (FD12.0).

A player is not required to announce the number of damage points that were actually required to destroy a given drone, only that the drone was destroyed by the damage scored against it.

**EXAMPLE:** A type-VI drone is destroyed by a bolted plasma-F at five hexes range. The bolting player only knows that the drone was destroyed, not that it took only three points of damage to do so. If the drone were a type-IV frame with three armor modules (12 damage points to destroy, six point warhead), the bolting player would be told only that the drone was not destroyed by the bolt.

**(FD1.55) MULTIPLE DRONES:** If several drones are in the same hex and one is destroyed, the others are not affected by that destruction but may be affected by whatever caused it in accordance with the rules for that cause.

**(FD1.56) DRONE VS DRONE:** The impact of any drone (except as noted in the rules) will destroy any other drone regardless of the warhead strength of the intercepting drone or the required destruction points of the target drone.

**(FD1.561)** This does not apply to the destruction of suicide or SP shuttles; they use the normal combat rules requiring a specified number of points to destroy. A suicide shuttle targeted on a drone (or another shuttle) will destroy it if it has enough explosive force to do so. A scatter-pack shuttle cannot "impact" its target; it will release its drones or try to evade if too close. A seeking shuttle without drones or a suicide bomb (J2.226) cannot destroy another drone or shuttle; if it reaches its target, it will simply stop moving and go inert.

**(FD1.562)** The following types of drone (or a drone with only these types of payload modules) will not damage another drone:

- Null drones (FD10.48).
- Probe drones (FD6.0).
- ECM drones (FD9.0).
- Expended Multi-Warhead bus vehicles (FD8.0), (FD1.7).
- Expended Swordfish bus vehicles (FD11.0), (FD1.7).
- Slug drones (FD13.0).
- Dummy seeking shuttles (J2.226).
- And others specified in their rules.

None of the above drone types are in Basic Set.

If there is more than one warhead type and both are on the above list, the drone will not destroy another drone. If one type is on the above list and the other is of a type that will destroy another drone, both are destroyed.

**(FD1.6) DRONE COMBAT**

**(FD1.61) IMPACT:** When an explosive drone enters the hex of its target, it explodes (F2.3) and scores a number of damage points on the facing shield equal to its warhead rating (FD2.1); also see (FD10.4).

**(FD1.62) SHIELD HIT:** Damage points are scored against the shield facing the direction of approach. [See (C1.313) for the effect of Tacs and HETs on shield facing.] Damage points in excess of the shield's strength are scored as internal damage. Some units do not have shields, but the direction is determined as if they did for various combat effects (e.g., directional phaser damage, which PA panel was hit, etc.).

**(FD1.63) COMBAT NOTES:** In practice, slower drones seldom reach their targets, although they may divert the fire of the target's phasers. To consistently score damage with a drone attack requires concentration. The drones must be launched from a position that improves their chances of a hit (i.e., don't launch them at a faster target moving away).

More drones must arrive during a given period of time than the target's defenses can deal with. Scatter-packs (FD7.0) can be used to increase the effective rate of fire.

A squadron of drone-armed fighters can overwhelm a target. The standard tactic is to launch one volley of drones from a distance, then follow them to the target and launch another volley at the start of the next turn so that all of the drones will arrive during one firing cycle.

**(FD1.7) EXPENDED DRONES; INERT WEAPONS**

**(FD1.71) DRONES:** Drones can become inert when:  
 they have reached the limit of their range,  
 they have lost their targets,  
 their tracking was discontinued under (F3.41) without their own on-board guidance,  
 their payloads have been expended (except where noted).

Inert drones immediately come to a stop and are removed from play during the subsequent Resolve Damage From Seeking Weapons Step. At that point, the drone destroys itself (without causing any damage). The drone cannot be recovered, located, detected, fired at, or detonated. Units, ESG fields, or other items moving through that hex cannot contact the drone.

**(FD1.72) SHUTTLES:** Shuttles and other size-6 or larger units moving by the seeking weapon rules which become inert remain in their hex and are not removed from play. Inert shuttlecraft can be captured and used again (subject to other specific restrictions and difficulties in capturing them). See (J1.86).

**(FD1.8) SEEKING SHUTTLES**

Suicide shuttles (J2.22), scatter-pack shuttles (FD7.0), and dummy suicide shuttles (J2.226) move (seek their targets) within the drone rules. They are treated as drones with the following exceptions:  
 Seeking shuttles are launched during the Shuttle Launch Step.  
 Direct-fire weapons (FD1.52) fire at seeking shuttles as shuttles, not drones.

Seeking shuttles can be recovered after going inert (FD1.72). Seeking shuttles are damaged as shuttles, not as drones. The damage seeking shuttles cause is specified in their own rules.

Non-fighter seeking shuttles cannot use an HET (J4.12). Seeking shuttles can be crippled. Seeking shuttles have the speeds and turn modes (J1.23) of shuttles, not drones. Seeking shuttles can be set for various speeds up to their maximum.

Specifically, seeking shuttles can be attracted by scouts (G24.23), have their lock-ons broken by scouts (G24.22), can have their guidance discontinued (F3.4), and can use ballistic targeting (F4.0). They cannot use EM (C10.17). A fighter used as a scatter pack benefits from its built-in ECM, but cannot receive lent EW from any unit but a scout.

**(FD2.0) TYPES OF DRONES**

There are some dozens of different types of drones, each of which has different characteristics. The basic drones used in the game are shown on the following chart. Various specialized drones are in Advanced Missions.

**(FD2.1) DRONE TYPE CHART**

Type	Speed	Endurance	Warhead	Damage	Space
I	8	3	12	4	1
II	12	2	12	4	1
III	12	25	12	4	1
IV	8	3	24	6	2
V	12	2	24	6	2
VI	12	1	8	3	1/2

**(FD2.11) COST OF DRONE TYPES**

The cost (S3.2) of replacing:  
 one type-I with one type-II is ..... 0.50  
 one type-I with one type-III is ..... 0.50  
 two type-Is with one type-IV is ..... 0.00  
 two type-Is with one type-V is ..... 0.50  
 one type-I with two type-VIs is ..... 0.00  
 one anti-drone with one type-VI is ..... 0.25

The cost (S3.2) of an extra:  
 type-I drone is ..... 1.0  
 type-II drone is ..... 1.5  
 type-III drone is ..... 2.0  
 type-IV drone is ..... 2.0  
 type-V drone is ..... 2.5  
 type-VI drone is ..... 0.5

Notes: See (FD2.54) and (FD2.55) for special restrictions on the type-VI drone. Unarmored type-III drones are always destroyed by four damage points whether they are single space drones, or two space type-III-X drones. It costs 1.0 points to trade a speed-8 type-I drone for a speed-12 type-III drone. For 0.5 points, you would get a speed-8 type-III drone, which technically does not exist (although it theoretically could).

**(FD2.12) X-DRONES:** There are advanced types of drones used by X-ships. The type-VII, type-VIII, and type-IX drones are used by X1 ships. The type-X, type-XI, and type-XII drones are used by X2 ships. See (X0.0). Pay close attention; there is a potential for confusion between the type-I-X (type one extended range) drone (which is *never* used by X-ships) and the type-IX (nine) drone, which is *only* used by X-ships.

**(FD2.2) EXPLANATION OF THE DRONE CHART**

Speed = number of hexes moved each turn.  
 Endurance = number of turns the drone remains in play.  
 Warhead = number of damage points scored on impact.  
 Damage = number of damage points required to destroy drone.  
 Space = size of the drone, expressed in "spaces."  
 Cost = the cost to exchange a type-I drone for this drone.  
 The cost of an extra drone of this type would be this figure plus 1 point. Note that two type-Is must be exchanged for each type-IV, and the cost of an individual extra type-IV is 2 points.

**(FD2.21) TYPES OF DRONES:**

The type-I drone is the standard type.  
 The type-IV drone is a larger version of the standard type-I drone, with a larger warhead.  
 Type-II drones are basically faster versions of type-I drones (just as the -V is a faster -IV). These burn out the standard engine at a higher rate. The type-II and -V drones all but disappeared when improvements in small warp engines increased the speed of all drones. They became available in Y77; see (FD10.65).

The type-III drones are long-range drones with active terminal guidance used in special situations.

The type-VI drone is a dogfight drone used by (or against) fighters.

**(FD2.22) IMPROVEMENTS:** Many optional improvements are available, each of which costs points that must be paid through (S3.2). All costs are based on additions to the basic cost of a type-I-slow drone. The BPV of all ships includes type-I-slow drones; the surcharges for improvements below must be paid in all cases (except X-ships). Note that because drone speed improves over time (years, not turns), drone-armed units may be required in a given scenario to pay the cost of higher-speed drones; see (FD2.454) in Basic Set or (FD10.5) in Advanced Missions.

**(FD2.221)** Active terminal guidance (FD5.2) costs 1/2 pt per drone. The warhead rating is not reduced. Drones with ATG have the designator H appended to their designation, e.g., Type-I-H. Type-III drones already have ATG, and type-VI drones have a form of ATG, and neither has a special designator.

**(FD2.222)** Extended range costs 1/2 point per drone and doubles the endurance. Drones with extended range have an X appended to their designation; this is not related to X-ships. (Type-III drones become IIIX with an endurance of 100 turns and size of two spaces). Any type of drone, EXCEPT a dogfight drone (FD2.5), can be modified to have double endurance. Extended range drones become available Y93.

**(FD2.223)** Medium speed (the speed is increased to 20) costs 1/2 point per drone. This is available from Y167. Medium speed drones have -M added to their designation; e.g., type-IM or type-I-M. There are no type-II-M or type-V-M drones.

**(FD2.224)** Fast speed (the speed is increased to 32) costs 1 point per drone. This is available from Y180. Fast drones have -F added to their designation; e.g., type-VI-F.

**(FD2.225)** When upgrading speed and exchanging sizes of drones, take the least expensive result.

**(FD2.226)** Type-VI speed upgrades cost 1/2 the normal amount (based on type-I upgrade costs). Type-IV drones pay the same speed upgrade cost as a type-I drone.

**(FD2.227)** Note specifically that type-III or type-VI slow drones are speed 12 as noted in (FD2.1), not speed 8.

### (FD2.3) SELECTION OF DRONES

**(FD2.31) STANDARD LOAD:** All drone racks are presumed to be loaded with type-I-slow drones. The ship has one set of reloads (enough to reload all of its racks one time) on board. (Any exceptions will be noted in the ship specifications.) This is included in the BPV of the ship. All drone-armed fighters include one complete load of slow drones as part of their BPV.

**(FD2.311)** Type-E drone racks are loaded with eight type-VI-slow drones. Type-VI slow drones are speed 12.

**(FD2.312)** Type-G drone racks are covered in (FD3.7).

**(FD2.313)** In Y175, all races refitted their drone-armed ships and provided additional reloads. This is defined in (R2.R4), (R3.R4), (R5.R5), (R8.R8), and (R12.R1).

**(FD2.32) ADVANCED DRONES:** If a player wishes to use advanced drones, he must pay a penalty (in victory points) for the privilege. Most advanced drones are in Advanced Missions, and rule (FD10.6) defines various limits on the availability of such drones.

The chart in (FD2.11) includes the cost of trading a standard type-I-slow drone for another type. Rule (FD2.22) includes the cost of various improvements. See also (FD10.0).

**EXAMPLES:** To exchange a type-I for a I-XFH (that is, extended range, fast speed, and active homing) would cost 2 points. To change all 16 drones on a Klingon D7 to "fast" drones would cost 8 points (the cost of converting the 8 drones in the racks, the reloads are free).

**NOTES:** Players should use reasonable judgement in their selection of drones. [Since no one does, see (FD10.6).] While it may seem perfectly logical to some to use only the best types of drone (such as the II-X and IV-X), this did not happen in the actual service. The better drones were more expensive and more difficult to produce and often just not available. Smaller ships (with their lower-ranking captains) received advanced models only if the larger ships were fully-stocked. Players who restrict themselves to only the very best

(and most powerful) ships and weapons are missing a great deal of the game. Throughout history, many decisive battles were fought with "outdated" or "inappropriate" weapons because the new ones were not available in quantity. The "Falklands War" of 1982 is an example of this, where outdated Skyhawk jets bombed "anti-submarine" ships.

### (FD2.4) LOADING

**(FD2.41) MIXING DRONES:** Drones may be mixed in drone racks as the players may elect. Any drone in a given rack may be fired (they are on a rotary launcher and do not have to be fired in order).

**(FD2.42) RELOADS:** A ship can reload its drone racks with drones from storage during combat.

**(FD2.421)** Up to two spaces of drones can be loaded on a given rack during a single turn, provided that the rack is not fired during the entire turn. [Two one-space drones (or four 1/2-space drones on an E-rack) can be loaded in the same time as one two-space drone.] This plan to reload must be plotted in advance, taking the rack out of service for that turn. This decision cannot be reversed. This must be a specific numbered game turn, not a period of 32 impulses. Drone racks are reloaded by assigned crew units, not by deck crews. The reload rate cannot be increased.

**(FD2.422)** Drone racks can be unloaded (perhaps to use the drones in a scatter-pack) by the same procedure and at the same rate, but cannot be loaded and unloaded on the same turn. An unloaded drone goes into the reload storage facility or into the cargo boxes. It cannot go directly (on the same turn) to another rack or to a scatter-pack or fighter.

**(FD2.423)** Drone and ADD reloads (other than those in cargo boxes) are stored in various locations around the ship and are considered destroyed with the last Excess Damage box. If all drone racks are destroyed and then one or more are repaired, the repaired racks can load the remaining reload drones within the limits of the rules.

**(FD2.43) STOCKPILE:** All ships are presumed to carry one complete set of reloads (i.e., drones equal to the number of spaces held by all of their racks). In addition, certain ships that operate fighters carry extra drones to equip these fighters; see Annex #7G. Drones carried by fighters or launched from drone racks are identical. Ships can purchase extra drones as part of the Commander's Options (S3.2). See (FD2.44) for an explanation of storage and (FD2.45) for an explanation of costs. See (K2.65) for PFTs. Reload drones may not be placed in the drone racks or launch rails of any unit [exception: Scatterpacks (FD7.212)] before the beginning of a scenario except as specified in a special scenario rule.

**(FD2.44) TYPES OF STORAGE, DAMAGE:** A ship armed with drones can have drones in one (or all) of five places:

**(FD2.441)** In the drone racks. The drone racks cannot hold more than their capacity, and any drones on a rack are destroyed when the rack is destroyed. Drone racks can be reloaded (FD2.42) with drones drawn from reload storage (FD2.442) or fighter storage (FD2.443).

**(FD2.442)** In the drone rack reload storage (which is not on the SSD) as per (FD2.42). This storage cannot exceed the capacity of the ship's original drone racks (subject to the double and triple-reloads of some ships). This storage is destroyed with the last Excess Damage box; see (FD2.423). This reload storage is automatically refilled from the drones in cargo boxes (if any). Extra drones purchased under (S3.2) can be added to this type of storage in excess of its capacity (but do not increase its capacity).

**(FD2.443)** In the storage facility for the fighters (if the ship is a carrier), see (J4.824), or PFs (if the ship is a PFT), see (K2.65). Non-carriers with drone-armed MRS shuttles will also have this type of storage. This cannot exceed the specified loading and is destroyed with the last shuttle box. This fighter reload storage is automatically refilled from the drones in cargo boxes (if any). Extra drones purchased under (S3.2) can be added to this type of storage in excess of its capacity (but do not increase its capacity). In the case of carrier tugs, there are separate such facilities in each hangar pod.

**(FD2.444)** In the shuttle bay loaded on a fighter, scatter-pack, MRS shuttle, other shuttle, or ready rack. These drones cannot exceed the capacity of what they are loaded on and are destroyed along with whatever they are loaded on (or in). Drones in the process of being loaded onto (or into) a system (rack, shuttle, etc.) are destroyed with that system. These systems (fighter ready racks, etc.) can be

reloaded from the drone rack reload storage (FD2.442) or fighter reload storage (FD2.443).

**(FD2.445)** In cargo boxes. Some drone-armed ships have cargo boxes to store extra drones. Unless otherwise specified a cargo box will hold 50 spaces of spare drones. It does not have them automatically, however, unless specified in the ship description. These drones are lost when the cargo boxes are destroyed. See (G25.3). These drones come at no cost, and are proportional to the loading of the racks.

**(FD2.446)** If various special drones are carried, then it will be necessary to maintain detailed records of what types of drone are in each position.

**(FD2.45) COST CALCULATION:** The cost of improved drones (FD2.22) is paid only for a single loading of each launch rack and/or fighter; the reloads (and drones stored on a carrier for use by its fighters) are presumed to be of the same type without additional cost. Carrier Escorts with ready racks for drone-armed fighters compute the costs for drone upgrades for drones in their fighter ready racks and storage for those racks as if they were carrying fighters (J4.621). Fighters are equivalent to drone racks for the purpose of loading ready racks.

There is a partial exception in the case of H-racks (FD3.84). D-racks are another exception.

Special drones must observe the proportional reload requirement (if identical reloads are not available, the reloads must be of the next most restrictive and expensive type), except for the LAST special drone in each percentage category. Thus, four Limited (10%) drones on a ship with double reloads would have to be deployed as two in the racks (and paid for) and two in reload storage. Any 25% drones have to be first used as reloads for the second rack-mounted 10% drone.

The drones in storage are proportional to those on the racks/fighters. They can be of a less expensive, but cannot be of a more expensive, type than the drones in the loading paid for. For example, if a Klingon D7B with two type-A drone racks had six type-I and two type-I-ECM drones in its racks, then the reloads (assuming a single set) could include up to two type-I-ECM and the rest type-I.

Note specifically that this rule does not allow you to purchase some special drones and then declare that all the special drones on your ship were loaded in the racks at the start of a scenario with the regular drones in reload storage.

**(FD2.451)** Reload drones are held in storage. If a given rack has two type-I and one type-IV drone (and equal reloads), the player cannot declare that the two type-IV drones are in the rack while the 4 type-I drones are in reload storage. The player could voluntarily change the loading of a rack through the reloading procedure, but this would have to be done during the scenario by taking the rack out of operation to unload and reload the drones.

**(FD2.452)** The reload drones are presumed to be of the same cost (or lower) as the drones in the rack (on a drone by drone basis), but might be of a different type. Thus, a MW drone might be in the rack while an ECM drone was in the reload storage.

**(FD2.453)** Drones cannot be transferred to another ship that did not pay for better drones because that ship would not have the facilities to store, maintain, and operate that type of drone.

**(FD2.454)** Ships are not required to pay for the drone speed that is general availability, and might for tactical reasons have some slower drones on board. Extra drones purchased as such can be of any available speed. A drone-using ship used during a period when medium- or high-speed drones are used is not forced to purchase those faster drones (which in effect increases their BPV). For example, a Kzinti CS has a BPV of 116. However, it has four drone racks, each of which holds four drones. Equipped with medium-speed drones, the BPV increases by 8 points (1/2-point per drone) to 124. The BPV of a Kzinti CS armed with fast drones is 132. (Of course, by the time fast drones were available, all CS-class ships had been refitted as BCs.) Normally, all drones on a given ship are of the same speed. There might be exceptions to this during a brief historical period when new technology was being introduced. Thus, a ship might have one fast drone per rack while the remainder were medium-speed drones.

## (FD2.5) DOGFIGHT DRONES

**(FD2.51) DEFINITION:** Type-VI drones are classed as "dogfight" drones. They are used primarily by fighters to shoot at other fighters. They can be fired from type-E and type-G drone racks and by anti-drone systems (E5.41). Dogfight drones cannot be loaded on or fired by any drone racks except E and G (and ADDs). Type-VI drones are extensively used in dogfights (J7.0). There are no variants (FD2.22) of type-VI drones except for speed upgrades. Note that type-H drone racks also include a magazine of type-VI drones.

**NOTE:** In earlier editions of the game these were known as type-IS or type-ISH drones. That designation is now obsolete in this context, and type-IS now means type-I-Slow.

**(FD2.52) FIGHTER EXCHANGE:** Any fighter which carries non-dogfight drones can trade those drones for type-VI drones on a one-for-one exchange. There is no BPV adjustment for this exchange. The exchange is one-for-one rather than two-for-one because the limitation is the number of launch rails, not size or weight.

**(FD2.53) EFFECTS:** Dogfight drones are not affected by many factors that affect other drones. See (FD5.1).

**(FD2.54) LIMITED DAMAGE:** Dogfight drones score 2 points of damage on size class 4 and larger targets (ships, bases, monsters, asteroids, planets). This is because the tiny warhead is designed to score a direct hit on a fighter engine instead of damaging the shields of a ship.

Dogfight drones contribute 2 points to WW collateral damage (J3.304).

Dogfight drones score 4 points of damage on size class 5 targets (PFs, interceptors, GBDPs, size-5 ground bases).

Dogfight drones score 8 points of damage on size class 6 and size class 7 targets (shuttles, large shuttles, defense satellites, mines). See (FD1.56) for the impact of a type-VI drone on another drone.

**(FD2.55) RANGE:** Type-VI drones have a maximum range of 12 hexes regardless of speed. The range cannot be extended. Obviously, movement induced by another means (e.g., black holes, being tractorred) does not count against the 12 hexes of the drone's range. While a type-VI can be launched at a target up to 35 hexes away [exception, (E5.41)], its endurance is limited to 12 hexes (FD2.55).

**(FD2.56) WARP SEEKERS:** Type-VI drones will acquire (lock-on to) their target when they move within 8 hexes of it and need no further guidance after that point. They can be released (F3.4) or the controlling unit can continue guiding them to provide ECCM support (or in case the target moves out of the 8-hex lock-on range). Type-VI drones, despite being warp seekers, cannot be used to cause selective damage on warp engines. Warp-seeking warheads cannot be used on any other type of drone. Warp-seeking drones can track any type of energy; see (FD5.11).

**(FD3.0) TYPES OF DRONE RACKS**

There are several types of drone racks in service; all are listed below. All drone racks are type-A unless specified otherwise in the ship descriptions. Most type-A drone racks were replaced with improved types in Y175. Players cannot change the drone racks on their ships except as provided in (S7.0). Drone rack types A, B, C, D, and F were in service in Y65. Type-E drone racks entered service in Y160. Type-G drone racks entered service in Y165.

Except as noted, no drone rack can fire two drones within 1/4 turn of each other, even if on different turns.

**(FD3.1) TYPE-A**

The standard "A-rack" or "type-A drone rack" has a capacity of four spaces of drones and can fire one per turn. Unless stated otherwise in the ship descriptions, all drone racks are of this type. Virtually all type-A drone racks were replaced with types B or C in Y175.

**(FD3.2) TYPE-B**

The larger "B" drone rack has a capacity of six spaces of drones and can fire one per turn. The Klingons favored this type of rack for its increased ammunition supply.

**(FD3.3) TYPE-C**

The "C" drone rack is designed for "rapid fire." Two drones may be launched from this rack during a single turn. These cannot be launched within 12 impulses of each other (even on consecutive turns). It holds four spaces of drones. The Kzintis favored this type of rack because it could put more drones in flight more quickly.

**(FD3.4) TYPE-D**

The type-D drone rack is used by battle stations, base stations, and the Kzinti tug and battle pod. It is a single launcher with three separate magazines. The launcher, in effect, moves from magazine to magazine and draws drones from whichever magazine it is adjacent to.

**(FD3.41) MAGAZINE SELECTION:** The launcher can draw one drone from one magazine on each turn. The magazine used is selected when the drone is launched. The launcher cannot fire two drones within one-quarter turn even if from different magazines. Each of the three magazines holds four spaces of drones. The drones can be of any type, but cannot be anti-drones. Type-D racks cannot hold type-VI drones; see (FD2.51) for the reason why.

**(FD3.42) DAMAGE:** Each "drone" damage point scored on a ship/base with a type-D drone rack destroys one magazine (the last one from which the launcher withdrew a drone), but not the launcher itself. (The launcher is destroyed with the last magazine.) The battle station SSDs in Module R1 have their magazine record tracks arranged to facilitate this procedure. The repair cost in Annex #9 repairs the launcher and/or one magazine.

**(FD3.43) HANDLING:** Any magazine can be taken out of service during a turn for reloading (or unloading) under (FD2.42) without affecting the launcher, so long as the launcher does not draw a drone from that magazine during the turn it is reloaded. While type-D (and type-H) drone racks do not have formal reloads, if reload drones became available (transferred from another ship, purchased as extras, stored in cargo boxes, etc.) they could be loaded into an unused magazine in this manner.

**(FD3.44) RELOADS:** There are no reloads for type-D drone racks; the reload drones are loaded in the spare magazines. The unit pays the drone upgrade surcharges for one magazine per launcher; the other two magazines per launcher are considered to have proportional free reloads.

**(FD3.45) WEAPON STATUS:** At the various Weapon Status levels, a unit with this type of drone rack may be presumed to have unloaded enough drones for use in the allowed number of scatter-packs.

**(FD3.46) PLASMA RACKS:** The plasma-racks on Romulan, Gorn, and ISC battle stations use the same system with three magazines, each holding four type-D plasma torpedoes. A given launcher cannot have drones in one magazine and type-D plasma torpedoes in another. An Orion base can have both types of racks so long as there is an even number of plasma racks, with each "pair" covering the entire 360° arc.

**(FD3.5) TYPE-E**

The "E" drone rack holds eight dogfight drones. It can carry no other types. Type-E drone racks (and type-VI drones) were originally designed for anti-drone defense, but later proved useful against fighters. Many fast patrol ships carried this version which proved useful in hunting fighters. This rack can fire up to four drones per turn, but cannot fire two drones within 1/4 turn (8 impulses) of each other, even on consecutive turns.

**(FD3.6) TYPE-F**

The "F" drone rack (known as the "jump rack") was a Klingon invention used to add drones to ships not originally designed for them. The drone racks seen on the B10, C9, C8, D7, D6, F5, and E4 are actually type-F racks replacing shuttles.

Type-F racks are functionally identical to type-A racks, except as follows:

They fire out of the shuttle hatch (D17.4) Level E.

They can explode in a chain reaction (D12.3).

They can only fire one drone from each *pair* of racks (FD4.3).

A drone launched from an F-rack counts against the shuttle launch rate (J1.5).

Other races did not use type-F racks, and Klingon ships with the B-refit have their type-F drone racks replaced with standard type-A racks (often with type-B after the Y175 refits). The only type-F racks in the game are on unrefitted Klingon ships of the types listed above. All of these "differences" cease to exist after the type-F racks are replaced with type-A.

**(FD3.7) TYPE-G**

**(FD3.70)** The "G" rack can carry four spaces of drones, and it is equipped with targeting system for anti-drones (E5.0). Each anti-drone takes 1/2 space. The G-rack can carry the 1/2 space type-VI dogfight drones or any other type of drone. Federation ships (which needed anti-drones on the Klingon front but not on the Romulan front) used this type of drone rack extensively. Other races seldom used it. The unique nature of type-G drone racks requires that their loading must always be planned (FD2.421). They do not automatically reload ADDs when empty as ADD racks do (E5.74).

**(FD3.71) MODES:** The rack can carry a mixture of types and can operate in either of two modes (drone or anti-drone) on a given turn.

If fired in the anti-drone mode, it cannot fire normal drones that turn, but can fire one anti-drone per impulse.

In the drone mode, it can fire one drone per turn.

The decision as to which mode to use is made the first time (each turn) it is fired. The mandatory 1/4 turn delay between subsequent launches from a single rack (FD3.0) includes the last firing on one turn and the first firing on the next. ADD fire counts as a drone launch event for this purpose.

Note that the 8-impulse delay applies if the rack is switching from ADDs to normal drones. If it fired as an ADD launcher on Impulse #32 of one turn, it could continue to fire as an ADD launcher on Impulse #1 of the following turn with no delay. If it launched a drone on Impulse #32 of one turn, it could not launch a drone or fire as an ADD until Impulse #8 of the following turn. If it fired as an ADD on Impulse #32 of one turn, and the player wanted to launch a drone from the rack during the following turn, he would have to wait until Impulse #8 to do so.

**(FD3.72) RELOADS:** Type-G drone racks have two sets of reloads, one of which is entirely anti-drones and the other of which is identical to whatever is loaded in the rack itself. When the type-G was given a third set of reloads in Y175, that set was identical to the loading of the rack.

Typically, a Federation ship on the Romulan border would have drones (with perhaps two anti-drones) in the rack and first reload and eight ADDs in the second reload. A Federation ship on the Klingon front might have 2, 4, or even 6 anti-drones on the rack (and in the first reload) with 8 anti-drones in the second. These are examples; the Federation player may select the actual load (and first reload) at his own discretion.

NOTE: This data is correct; that on the various Federation SSDs in early printings is unclear.

**(FD3.8) TYPE-H STARBASE DRONE RACK**

This type of drone rack was installed only on starbases. It consists of a launcher and a series of five compartmented magazines. The launcher, in effect, moves from magazine to magazine and draws drones from whichever magazine it is adjacent to.

**(FD3.81) MAGAZINE SELECTION** The launcher can draw one drone from one magazine on each turn. The magazine used is selected when the drone is launched. The launcher cannot fire two drones within one-quarter turn even if from different magazines. Each of the five magazines holds four spaces of drones. In four of the magazines for each launcher, the drones can be of any type, but cannot be anti-drones. The fifth magazine holds eight type-VI drones; if this magazine is selected, it can fire as a type-E drone rack (FD3.5).

**(FD3.82) DAMAGE:** Each "drone" damage point scored on a starbase destroys one magazine (the last one from which the launcher withdrew a drone), but not the launcher itself. (The launcher is destroyed with the last magazine.) The starbase SSDs in Module R1 have their magazine record tracks arranged to facilitate this procedure. The repair cost in Annex #9 repairs the launcher and/or one magazine. A repaired magazine will of course be empty.

**(FD3.83) HANDLING:** Any magazine can be taken out of service during a turn for reloading (or unloading) under (FD2.42) without affecting the launcher, so long as the launcher does not draw a drone from that magazine during the turn it is reloaded.

**(FD3.84) RELOADS:** There are no reloads for type-H drone racks; the reload drones are loaded in the spare magazines. The starbase pays the drone upgrade surcharges for two magazines per launcher; the other two standard magazines per launcher are considered to have proportional free reloads. The fifth (type-VI) magazine is never charged for speed upgrades. Starbases are treated as CVAs for purposes of allowed racial drone percentages (but do not include their type-VI drones or anti-drones in those calculations).

**(FD3.85) WEAPON STATUS:** At the various Weapon Status levels, a starbase may be presumed to have unloaded enough drones for use in the allowed number of scatter-packs.

**(FD3.86) ANTI-DRONES:** The anti-drones on starbases and BATS use an identical five-magazine system; see (E5.53). Each anti-drone launcher has five six-round magazines and can draw from one magazine at a time. It takes 4 impulses to switch from one ADD magazine to another, but these ADD-30s are otherwise treated as type-H drone racks. Base Stations do not use this type of ADD.

**(FD3.87) PLASMA RACKS:** The plasma racks (FP10.0) on some Romulan, Gorn, and ISC starbases, battle stations, and base stations use the same system with five magazines, each holding four type-D plasma torpedoes.

**(FD3.9) TYPE-P**

There is no type-P drone rack, but the plasma rack (FP10.0) is often abbreviated P-rack and this entry is provided for the reference of players who mistake it for a type of drone rack. See also (FD3.87).

**(FD4.0) LAUNCHING RATES**

**(FD4.1) RACK TYPES**

Unless stated otherwise in the ship descriptions, or when player-modifications (S7.0) are being used, all ships are assumed to have "type-A" drone racks. See (FD3.0).

**(FD4.2) BASIC RATE**

Unless stated otherwise in the ship descriptions, or when using player-modifications, all ships are presumed to be able to launch one drone from each of their racks each turn.

**(FD4.3) EARLY KLINGONS**

Some older Klingon ships had an early form of drone rack (FD3.6) that limited the launch rate. These ships can, each turn, use a number of drone racks (at the appropriate firing rate for each rack) equal to half the original number of racks (round fractions up). These ships include:

Ship	# of racks	Drones launched per turn
C9	4	2
C8	6	3
D7	2	1
D6	2	1

The B-Refits for these ships replaced the F-racks with A-racks and removed this restriction. Note that the smaller F5 and E4 also have F-racks, but because they have only one drone rack, there is no restriction. The original (unrefitted) design of the B10 (8 racks, launches four per turn) should be on this list, but since the ship could not have been completed before the refit, it could never have existed.

**(FD4.4) BASIC ORION**

Many Orion ships (most of which are in other products) can mount large numbers of drone racks in their optional weapon mounts. None of these ships, however, can launch drones from more than three of their drone racks during a turn (at the appropriate firing rate for the type of rack).

These restrictions also apply to Orion ships with plasma racks (FP10.0) and combinations of drone and plasma racks. The limit of three drone racks or plasma-D racks firing per turn (each at up to their maximum rate) includes both types (i.e., three total, not three of each). The launch restriction does not include anti-drones or seeking shuttles (or any other weapon).

**(FD4.5) OAKDISC**

Some Orion ships are configured for long-range drone bombardment or for short-ranged anti-fighter work. These have sufficient tracking capacity to fire every rack (at its maximum rate) every turn and to control a number of seeking weapons equal to double the current sensor rating. [An Orion ship could further increase its seeking weapon control abilities by installing a special sensor in an option mount and using (G24.24).]

This modification, known as OAKDISC (Orion Advanced Killer Drone Improved System of Control) costs a set number of BPV points for each ship to which it is applied. This cost is given in the description for each ship.

This specific rule has precedence over the general ship modification rules (S7.0) for improving the seeking weapon control ability of a ship. The only means of improving seeking weapon control on an Orion ship is that given in this rule, i.e., OAKDISC.

OAKDISC also applies to plasma racks and ships with both plasma and drone racks (FD10.43).

**(FD5.0) METHODS OF CONTROL**

There are basically three methods of controlling drones: energy seeking, self-guiding, and launcher-controlled.

The standard and most common form of guidance is launcher guidance; see (FD5.3).

**(FD5.1) ENERGY SEEKING DRONES**

**(FD5.11) WARP SEEKER:** Type-VI dogfight drones (FD2.5) are all controlled by warp-energy seekers, which look for and home in on the emissions of warp energy by their targets. (The drone can find any type of energy it was told to look for, so the target need not have warp energy. They can be targeted on asteroids, for example.) Turning off or dropping a ship's warp engines, or the fact that they have been destroyed, will not prevent the drones from tracking their target.

**(FD5.12) LAUNCH REQUIREMENT:** These drones require guidance until they achieve their own lock-on (at a range of 8 hexes). At that point, the controlling ship may (but is not required to) release guidance. If guidance is released, the drone will assume self-guidance. (It cannot be commanded to go inert.)

The guiding unit (and hence the launching unit) must, of course, have a lock-on to the target. This is not required in the case of a dogfight (J7.0) or launch under passive fire control (D19.22).

**(FD5.13) NON-DISTRACTION**

**(FD5.131)** Dogfight drones that have gained their own lock-ons (even if still under control of another unit) cannot be distracted by electronic warfare (D6.3), wild weasels (J3.2), cloaking devices (G13.3345), SWACS (J9.2), or scouts (G24.22) and (G24.23). A dogfight drone which strikes a cloaked ship does *not* allow a lock-on by other units. Type-VI drones that gain a lock-on to a friendly unit can be inactivated by a tractor beam (G7.522).

**(FD5.132)** Dogfight drones can be distracted by chaff (D11.0).

**(FD5.133)** WW, SWACS, cloaking devices, and scouts could divert a dogfight drone that did not yet have its own lock-on.

Type-VI drones on a scatter-pack are defined by (FD7.37).

Type-VIs targeted on a WW will not revert to their original target if the WW is voided or destroyed.

Note that in the case of the cloak, if the drone did not have its own lock-on to the cloaking target, it would lose tracking and be removed from the board.

**(FD5.14) TYPE-VI ONLY:** Energy-seeking guidance is used only on 1/2-space dogfight drones and cannot be used on any other type of seeking weapon.

**(FD5.15) MOVEMENT:** The restrictions of (FD5.23) also apply to this type of drone.

**(FD5.2) ACTIVE TERMINAL GUIDANCE; SELF-GUIDING DRONES.**

Any drones (other than type-VI) can be equipped with active terminal guidance (ATG) as a Commander's Option (S3.2) for a cost in BPV points. ATG drones can guide themselves, but they can be distracted by electronic warfare, wild weasels, SWAC/scouts, cloaks, or chaff.

Federation scientists, while working on a deep space probe design, developed the technology for the active terminal guidance system. During the third Klingo-Kzinti War, a special treaty between the Federation and the Kzinti Hegemony resulted in various exchanges between the two fleets (including Federation observers serving on Kzinti ships and occasionally piloting Kzinti attack shuttles), one of which was this technology being passed on to the Kzintis. Shortly after they began using it, the Klingons began issuing their forces with this type of drone (and less than a year later, the Orion pirates were using it).

**(FD5.21) PROCEDURE:** A drone equipped with active terminal guidance (ATG), after closing to within 8 hexes of its assigned target, does not require command guidance from the launching ship but will track and follow the target independently if it is released (F3.42) at

that point. ATG drones must keep the target in their FA arc to track it; see (FD5.23).

If launched within 8 hexes of their target, ATG drones can lock-on immediately. However, the launching unit must have the ability to control the drone before it can be launched. A unit that is already controlling its maximum number of drones cannot launch an ATG drone, even if that drone would immediately have its own lock-on. If only one control circuit were available, and the target was within 8 hexes, the unit could launch one ATG (or dogfight) drone per impulse, releasing each drone on the next impulse and launching another one in the same Seeking Weapons Stage.

Passive fire control (D19.22) cannot be used to launch ATG drones while the fire control system is in active mode.

**(FD5.22) COST:** Any drone other than a type-VI may be equipped with ATG. This costs 1/2 BPV point; see (FD2.221). The warhead is not reduced.

**(FD5.23) LOSING LOCK-ON:** If, after acquiring its target and being released (F3.42) by the controlling unit to self-guidance, circumstances cause the drone to be more than 12 hexes from the target (or the target is outside of the FA arc) at the end of an impulse, lock-on is lost and the drone becomes inert (i.e., is removed from play under FD1.7). See (G18.64).

**(FD5.24) CLOAKED SHIP:** An ATG drone that is not controlled by a ship will roll for its own attempt to retain lock-on under (G13.33). If an ATG drone is controlled by a ship, the ship rolls to retain a lock-on. If this fails, the drone is released from control (it cannot be transferred) and can immediately roll for its own attempt to retain lock-on. ATG drones have an assumed sensor rating of six. See (FP4.5).

**(FD5.25) TYPE-III DRONES:** All type-III drones include a special form of ATG which does not require outside guidance and which can find its own targets after launch.

**(FD5.251)** A type-III drone can be launched as a standard ATG drone, with control retained until it achieves its own lock-on.

**(FD5.252)** A type-III drone can be launched on a ballistic course to seek its own target. It will accept the first enemy unit in its FA arc, eligible for lock-on, and within 8 hexes. This is known as "Tame Boar." At this point, it will lock-onto that target and assume self-guidance. The owning player can designate the acceptable size class of target at the time of launch using (FD7.3). [If you do not have Advanced Missions, this can be any size class.] This cannot be changed after launch. This also applies to MW versions of type-III drones. See (FD5.256) for an optional targeting system. If there are more than two targets that meet the drone's targeting, select the nearest one to be the target. If they are equally near, determine the one to be pursued randomly (by die roll) for each drone.

**(FD5.253)** Type-III drones cannot be placed in a scatter-pack; see (FD7.12).

**(FD5.254)** Type-III drones also include built-in ECCM (D6.393).

**(FD5.255)** Type-IIIXX drones, because of their unique long range, can use a system known as "Wild Boar." (This is not related in any way to a wild weasel, PFS, or SWAC.)

The drone is launched on a long ballistic course toward an area where enemy units are thought to be present. This course may include a maximum of three "waypoints" or intermediate targets. After reaching each waypoint (which can be up to 1,000 hexes apart), the Wild Boar will switch to the next waypoint. During this time, the drone will ignore any targets (including those which attack it).

After the final waypoint, it will activate its sensors and proceed on a programmed course (which can only be a straight line from the final waypoint or a circle of a defined radius) until its fuel is exhausted or it locates a target (FD5.252). It will then accept that target and attack. When the drone starts looking for acceptable targets, it accepts the first in terms of distance of those acceptable targets. Thus, if it was set to pursue either a frigate or a dreadnought, and both were in its range limit, it would pursue whichever was closer to it, even though the player might want it to pursue the other target instead. If two or more targets are equally close, the actual target is determined randomly by placing duplicate counters of each possible target into a cup and drawing one to maintain the secrecy of the drone's target. For multiple drones, have a neutral player observe these draws.

**(FD5.256)** Players can use a more accurate targeting system in (FD5.252) instead of (FD7.3). The player can specify a tactical

intelligence hull type. See Annex #10. Basic and § hull types can be specified. For example, you could tell it to attack a C8H, but if a C8V and a C8S were both present, it would take the first one it saw.

**(FD5.257)** A drone launched on either a Tame Boar or Wild Boar trajectory will ignore any unit protected by an active wild weasel when it begins to search for targets. It will accept a wild weasel launched by such a unit as that type of unit as any other drone would. If a unit voids such a weasel, and the drone is within 12 hexes of the unit, the drone will accept the unit as its target, but if the distance is more than 12 hexes, the drone will go inert and be removed from play.

**(FD5.26) BUILT-IN ECCM:** ATG drones have two points of built-in ECCM; see (D6.393). This is treated as per (F3.33).

### **(FD5.3) LAUNCHER-GUIDED DRONES**

This is the standard and most common form of drone guidance. If a given drone does not have ATG or is not a warp seeker (or is not yet close enough to acquire its target via those systems), it must be guided to the target by the launching unit [or another unit that assumed control under (F3.5) Transfer]. Note that the term "launcher-guided" does NOT mean that the player can move the drone at will, but that his ship has focused a targeting system on the target to identify it to the weapon. The player cannot change the drone's target after launch.

**(FD5.31) REQUIREMENTS:** To guide drones, a unit must satisfy the conditions of (F3.3) and of (F3.0) generally.

**(FD5.32) TERRAIN:** Planets can cause a lock-on to be broken (P2.3). In some cases the drone may suddenly accept the planet as its target and strike the planet. (Since the warheads of drones are thermonuclear, this could cause considerable damage.)

**(FD5.33) TRANSFER:** A unit guiding a drone to a target can transfer control of the drone (i.e., responsibility for its guidance) as per (F3.5).

**(FD5.34) ELECTRONIC WARFARE** can reduce the effect of a hit by a drone by causing the weapon to explode at a distance (well inside the target hex) from the target rather than against its shields; see (D6.36).

**(FD5.35) CUTTING TRACKING:** A unit guiding a drone can discontinue guidance under the terms of (F3.4). This could cause the drone to go inert (FD1.7). Note that a unit need not discontinue guidance of a drone if the target was destroyed. The unit could still guide the drone to the hex where the target was destroyed, at which point the drone would become inert. This might be done for deception purposes, to cause collateral damage (J3.3), to damage an ESG or detonate a mine, or for some other purpose.

**NOTE:** The "scrambling device" in rule (FD5.4) of previous editions of SFB was deleted in the Captain's Edition.

### **SYNOPSIS OF DRONE RULES IN STAR FLEET BATTLES ADVANCED MISSIONS**

To aid in later integration of Basic Set with a whole range of advanced and expansion products, the Basic Set rules are filled with numerous cross-references to the rules from those other products. Of course, if you do not have a given product, then any rules from that product cannot be used; they do not impose any penalties or provide any benefits to the player. To aid in understanding the Basic Set rules, and to prevent confusion over these references to rules in other products, the following synopsis of these rules is provided.

**(FD6.0) PROBE DRONES:** These were designed to conduct scientific investigations from safe distances, but often are used in combat for Tactical Intelligence.

**(FD7.0) SCATTER-PACK SHUTTLES:** It is possible to load up to six drones onto an administrative shuttle, launch it on a seeking or ballistic course, and have it release the drones when a defined target enters its detection range.

**(FD8.0) MULTI-WARHEAD DRONES:** Certain types of drones carry three or five type-VI dogfight drones instead of a conventional warhead. Designed as an anti-fighter weapon, these proved to be a devastating anti-drone defense.

**(FD9.0) ECM DRONES:** These drones have an ECM generator and can be used to protect a key ship from damage or to jam the fire controls of an enemy ship.

**(FD10.0) DRONE CONSTRUCTION:** A "build your own drone" kit allowing players to combine various drone frames, engine speeds, and special-purpose modules to create unique drones for Advanced Missions.

**(FD11.0) SWORDFISH DRONES:** To avoid having the enemy fire at the last second to score the most damage on your drones, you can use some Swordfish drones in your next drone bombardment. These drones fire a phaser at the target!

**(FD12.0) ARMORED DRONES:** To survive enemy defenses, you can replace part of the warhead with armor. If you want full effect, you can use external armor, although this will slow down the drones.

**(FD13.0) SLUG DRONES:** These drones are all armor and no explosive warhead. Sound strange? Not after you have seen the Lyran Expanding Sphere Generator (in Module C1).

**(FD14.0) SPEARFISH DRONES:** The armor-piercing drone, Spearfish makes only a small hole in the enemy shields but causes internal damage without having to knock the shields down entirely.

**(FD15.0) STARFISH DRONES** are basically multi-warhead drones loaded with ADDs instead of type-VI drones.

**(FD16.0) STINGRAY DRONES** were an early forerunner of the multi-warhead drones, fitted with a single type-VI submunition.

**END OF SECTION (FD.0) BASIC SET**



## (FP0.0) PLASMA TORPEDOES

### (FP1.0) GENERAL RULES

A plasma torpedo is a ball of matter on the brink of being converted totally to energy. The weapon is extremely powerful. It is used by the Romulans and Gorns as well as by the Orion pirates and (in Module C2) by the Interstellar Concordium. There are several different types of this weapon, each with different warhead strengths and energy costs.

#### (FP1.1) LAUNCHERS

**(FP1.11) SSD:** Each "PLAS" box on the SSD represents one plasma torpedo tube and can arm and fire one plasma torpedo at a time. Exception: (FP7.0).

**(FP1.12) TYPE:** The specific type (FP2.0) of launcher in each case is shown on the SSD. From largest to smallest, these are the Plas-R, Plas-S, Plas-G, Plas-F, and (in Advanced Missions) the Plas-D.

**(FP1.13) DOWNLOADING:** Any given plasma torpedo launcher may be used to load a less powerful, but not a more powerful, torpedo than that for which it is rated. Thus, a plasma-S launcher could load and fire a plasma-G but never a plasma-R. This is known as "downloading" or simply "downloading." A non-X tech plasma-R can be downloaded as a plasma-S prior to the Y170 invention of the plasma-S, but cannot be launched as a plasma-M or Plasma-L.

**(FP1.131)** Downloading is done as the torpedo is arming. It is not possible to reduce the status of a torpedo that is already armed and held. For example, a ship that has paid two units of power on each of the previous two turns for its S-torp launcher can complete the torpedo as a type-S or type-G, but not as an F as that requires one point per turn on the first two turns. To some extent, the two-turn-F (FP1.93) is an exception to this rule.

**(FP1.132)** A plasma-torpedo launcher that can be loaded at a given weapon status can be downloaded at that status. Launchers larger than type-F can have a type-F downloaded at the start of the scenario if the weapon status allows the launcher to have a standard torpedo loaded, but cannot have a downloaded type-F at WS-0 (whereas an actual type-F launcher could be holding a torpedo at that status).

**(FP1.133)** Type-F and larger launchers cannot download a type-D torpedo.

**(FP1.14) DISCHARGE:** If the energy to hold a completed plasma torpedo is not paid, the torpedo will be ejected by the crew at the end of the Energy Allocation Phase. This ejection can be detected and must be announced. It cannot be simulated by a PPT (FP6.0).

A torpedo must also be ejected if it cannot legally be held (plasma-R on some ships, shotgun, enveloping).

A torpedo must be ejected if the launcher was destroyed (FP1.7) and the torpedo has no target when the post-destruction period has expired. If the ship is tumbling, the torpedo cannot be targeted and will be discharged (not launched). See (C6.558), see also (C6.5473).

It would also be possible to fire a torpedo on a ballistic course (within the Sequence of Play) rather than eject it. At least then it would be of some deception value. This is actually the preferable means of discarding a torpedo that cannot be held.

**(FP1.15) SELF-DAMAGE:** You cannot voluntarily "destroy" a plasma torpedo tube on your own ship in order to claim the use of (FP1.72) to "hold" the torpedo until sometime in the subsequent turn.

#### (FP1.2) ARMING

**(FP1.21) PROCEDURE:** Each plasma torpedo requires three turns to arm. Energy must be allocated to the specific launch tube on each of three consecutive turns. The different types of torpedoes cost different amounts of energy to arm. These costs are shown in the rules for each torpedo (FP2.0). The arming energy can come from any source.

Exception: Accelerated arming (FP1.93).

**(FP1.22) ENERGY:** The energy to arm the torpedo must be applied over a three-turn period in EXACTLY the increments shown in (FP2.51). No more energy can be allocated; if any less energy than required is allocated, the weapon is lost and must begin arming all over again.

**(FP1.221) ROLLING DELAY:** A ship may, in effect, delay the firing of a type-R, S, G, or F plasma torpedo by only allocating two units of energy (one point for a plasma-F) on the third turn of arming. If done, the first turn's energy is lost [at the end of the turn; see (FP1.91)], and the second and third turns (two energy points each) become the first two turns of the three-turn arming cycle (unless the torpedo is completed with reserve power as in FP1.222). Mark an "R" on the EAF to avoid confusion.

**(FP1.222)** If the launcher is in its third (or later) turn of arming without paying the full cost (using the rolling delay system), the arming can be completed (paying the difference between the normal third-turn energy cost and the rolling delay energy paid) at any time during the turn with reserve power. The torpedo must then be fired before the end of that turn. See (FP1.91).

**(FP1.223)** A torpedo held by rolling delay can be completed as an EPT or shotgun during the Energy Allocation Phase (not by reserve power), but such arming is irrevocable and the torpedo must be fired on that turn.

**(FP1.23) PRIOR ARMING:** Plasma torpedoes are expensive (in power) to arm and hold. A ship would not normally travel for months with loaded torpedoes just in case trouble showed up. Ships do not normally begin scenarios with plasma torpedoes armed, but might have armed them if combat were known to be imminent; see (S4.0) Weapon Status.

**EXCEPTION:** Plasma-F torpedoes, held in stasis boxes, can be held almost indefinitely and are always ready at the start of a scenario, except when the ship is "surprised" (D18.12). Plasma-D torpedoes, while in stasis canisters, must be energized (FP9.2) before they can be fired, and this is not normally done unless specified by (S4.0).

**(FP1.24) HOLDING:** If not fired on the third turn, the torpedo can be held for the appropriate energy cost (FP2.5). If the holding energy is not paid, the torpedo is ejected. There is no 8-impulse holding period as per (FP1.71). Mark an "H" on the EAF to avoid confusion.

#### (FP1.3) LAUNCHING

**(FP1.31) PROCEDURE:** A plasma torpedo may be launched during the Impulse Activity Segment of any impulse during the turn in which arming is completed.

**(FP1.311)** If a completely-armed torpedo is not launched during the final turn of arming, it may be held over and launched during the next subsequent turn (exception: type-R torpedoes armed by ships cannot be held, those on starbases can be) by paying a specified energy cost to hold the torpedo (exception: type-F torpedoes in type-F launchers cost nothing to hold). It can be held indefinitely by paying the holding cost during Energy Allocation of each subsequent turn.

**(FP1.312)** The torpedo must be launched in accordance with the tracking arcs (FP3.0) available for that tube. When the torpedo is placed on the board, it must be facing in a direction available to that launch tube and must have the target in its (the torpedo's) FA arc. The target of a plasma torpedo must be announced when it is placed on the board, unless using (F3.6).

**(FP1.313)** Plasma torpedoes can be targeted on anything except another plasma torpedo. The "friendly fire" rules (D1.5) will create some exceptions to this rule.

**(FP1.32) WARHEAD:** When a plasma torpedo is placed on the board, the owning player must state the warhead strength if there is an enemy unit within 35 hexes (FP1.323).

**(FP1.321)** This information will be of tactical benefit to the enemy. EPTs (FP5.0) will of course be recognized immediately by their higher strength. Type-F and type-G torpedoes will appear identical when first launched.

**(FP1.322)** If the launched torpedo is a PPT (FP6.0), the owner must state the warhead strength of the type it is simulating (although not that it is a simulation).

**(FP1.323)** The warhead strength is known continuously as the torpedo travels across the board, so long as one enemy unit is within 35 hexes of the torpedo. [Level B if using the Optional Tactical Intelligence rules, (D17.4), in which case the range would vary.] Active fire control is not required, and a cloaked ship can observe the size of the warhead. The owning player is not required to announce any change in warhead strength of a given torpedo, but must answer correctly if asked at any point.

**(FP1.33) SAME HEX:** Plasma torpedoes can be launched in the same hex as their targets; see (F2.32) for the same-hex procedure and (FP1.86) for feedback damage to the launching ship.

**(FP1.4) MOVEMENT**

**(FP1.41) SEEKING WEAPONS:** Plasma torpedoes are seeking weapons and move by (F2.0).

**(FP1.42) ENDURANCE:** Plasma torpedoes have a maximum endurance of 32 impulses, but, as their warhead strength steadily decreases, they will reach zero strength before moving all 32 hexes. If a unit that is a target of a plasma torpedo enters the hex of that torpedo as part of its movement, the torpedo strikes the target and is not regarded as having moved that impulse for purposes of warhead reduction.

**(FP1.43) SPEED:** All plasma torpedoes move at a speed of 32.

**(FP1.5) WARHEAD STRENGTH**

**(FP1.51) STRENGTH CALCULATION:** The warhead strength of a plasma torpedo is determined at the instant of impact, based on two factors: the distance that the torpedo has traveled (it grows weaker the farther it travels) and damage done to it (FP1.6) by phasers and (possibly) other effects. This may be further adjusted by the effects of electronic warfare (D6.36). The warhead strength vs range (for each type) is shown on the Plasma Torpedo Table (FP1.53). The warhead strength decreases with range, as is shown on the plasma torpedo tables. Once the warhead strength reaches zero, the torpedo has no further effect or function and the counter is removed from the board. Terrain-induced movement (black hole, nebula) does not count as movement for purposes of lowering the warhead strength.

**(FP1.52) SEQUENCE:** The damage is applied during the Seeking Weapon Impact Step (or the Enveloping Plasma Torpedo Impact Step); see the Sequence of Play in Annex #2.

**(FP1.53) PLASMA TORPEDO TABLE:** See bottom of page.

**(FP1.6) FIRING AT PLASMA TORPEDOES**

**(FP1.61) DAMAGING PLASMA TORPEDOES:** Plasma torpedoes may be fired at only by phasers (of any type). ONLY phasers or impact with a large object (such as a planet or asteroid), and some other terrain types listed below, will damage a plasma torpedo.

**(FP1.611)** Every two points of damage by phaser fire reduces the warhead strength by 1. Note that this reduction is below the normal strength shown on the Plasma Torpedo Table.

**(FP1.612)** Record damage points made on a plasma torpedo during its movement, and adjust the strength of the weapon accordingly on impact or when asked for current warhead strength.

**(FP1.613)** Damage from planetary rings (P2.223), asteroids (P3.24), pulsars (P5.33), nebulae (P6.73), and dust clouds (P13.3) counts as phaser damage.

**(FP1.614)** MCIDS can damage plasma; see (E6.5).

**(FP1.62) OTHER WEAPONS:** No other weapon, including another plasma torpedo, will damage a plasma torpedo. No other effect (for example: self-destruction blast, mines, expanding spheres) will damage a plasma torpedo unless specifically stated to do so.

A displacement device, while it won't damage a plasma torpedo, can relocate it (G18.71).

A plasma torpedo cannot accept another plasma torpedo as a target (FP1.313).

**(FP1.63) OTHER TERRAIN:** Each hex of atmosphere (P2.85) or gravity wave (P9.312) traversed by a plasma torpedo reduces the strength.

**(FP1.7) SPECIAL COMBAT RULES**

**(FP1.71) FIRING AFTER DAMAGE:** If a plasma torpedo has been armed, and the torpedo launch tube is destroyed while holding a fully-armed torpedo, the torpedo may be launched within eight impulses; otherwise it is destroyed. The torpedo cannot be held. Destruction of the plasma torpedo systems box on the SSD destroys the ability of the ship to produce new weapons, but not its ability to fire the one it has already created. This does not apply to fighters with plasma-torpedoes and is superseded by (J1.332).

If the ship has broken down, see (C6.5473).

**(FP1.72) SUBSEQUENT TURN:** If the 8-impulse time period (in which the torpedo can be fired from the destroyed tube) extends into the next turn, it can be fired then and no holding energy need be paid.

**(FP1.73) PPT:** The PPT of a destroyed tube can also be fired during this interval.

**(FP1.74) CLOAKED SHIP:** If a launch tube on a cloaked ship is destroyed, the ship will have to uncloak to fire the torpedo at a target. If still cloaked, the torpedo will be ejected. In this case the torpedo could not be launched ballistically (FP1.14).

**(FP1.8) OTHER SPECIAL CASES**

**(FP1.81) DISTRACTION:** Plasma torpedoes may be distracted by "wild weasel" shuttlecraft (J3.0) or by wild SWACS (J9.2). Plasma torpedoes may accept planets as their target under some conditions; see (P2.33).

Type-D torpedoes (and only that type) can be distracted by chaff; see (FP9.18).

**(FP1.82) TERRAIN:** Plasma torpedoes are affected by some types of terrain. See (FP1.613) and (FP1.63). Also, black holes (P4.22) and some other terrain types generate EW points which could affect the probability of a hit.

**PLASMA TORPEDO TABLE**

TYPE	RANGE														
	0-5	6-10	11-12	13-14	15	16-18	19	20	21-23	24	25	26-28	29	30	
R	50	50	35	35	35	25	25	25	20	20	20	10	5	1	
S	30	30	22	22	22	15	15	15	10	5	1	0	0	0	
G	20	20	15	15	15	10	5	1	0	0	0	0	0	0	
F	20	15	10	5	1	0	0	0	0	0	0	0	0	0	
D	10	8	5	2	1	0	0	0	0	0	0	0	0	0	
BOLT	1-4	1-3	1-2						1						

**(FP1.83) STASIS:** Plasma torpedoes may be placed in a stasis field (G16.62).

**(FP1.84) MINES:** Mines (other than phaser-captors) will not damage a plasma torpedo. Mines (except phaser-captors) will not accept plasma torpedoes as targets; see (M4.221) and (M2.48).

**(FP1.85) OVERLOAD:** Plasma torpedoes cannot be overloaded.

**(FP1.86) FEEDBACK:** If the torpedo is launched in the same hex as its target and hits (impacts) its target before the target or launching ship moves to another hex, the firing ship receives "feedback" damage on the shield facing the target equal to 25% of the warhead's strength. This does not reduce the warhead's strength. As with similar rules for photon torpedoes and disruptors, this does not affect any other unit in that hex. If the effect of the torpedo is reduced by electronic warfare, the feedback damage is reduced by an equal percentage. Feedback may also be reduced by a target's Cloak (G13.37).

**(FP1.87) TRACTORS:** Plasma torpedoes cannot be held in a tractor beam (G7.26).

### (FP1.9) ARMING WITH RESERVE POWER

Reserve power may be applied to a plasma torpedo held in the launch tube to complete its arming. The following restrictions apply.

**(FP1.91) ROLLING DELAY:** Reserve power can be used to supply the additional energy required to complete the arming of a torpedo held by rolling delay (FP1.221). If two points had been allocated on Turn #1 and two points on Turn #2, and then only two points were allocated on Turn #3, the energy from Turn #1 is not lost; the torpedo can be completed with reserve power during a later portion of the turn. The Turn #1 energy will be lost if the torpedo is not completed by the end of Turn #3. Note that plasma-F launchers can use rolling delay (FP1.221), but cannot use (FP1.93) below.

**EXAMPLE:** A ship with a type-S launcher could pay two points of energy on Turn #1, two points on Turn #2, and two points on Turn #3. During any impulse of Turn #3, it could pay one point from reserve power to complete the arming of a type-G torpedo or two points to complete the arming of a type-S. If this is not done, the torpedo is still "arming" and Turn #4 becomes the third turn of the arming cycle.

**(FP1.92) EPT & SHOTGUN:** Reserve power cannot be allocated to complete the arming of an enveloping plasma torpedo (FP5.0) or of a plasma shotgun (FP7.0).

**(FP1.93) ACCELERATED ARMING:** Reserve power (not allocated power) can be used during the launch/fire step for accelerated arming of type-G, type-S, or type-R torpedoes. During the second turn of arming, these weapons (with two energy points allocated on the first turn and two on the second turn), two points of reserve power can be applied to produce a type-F plasma torpedo. This torpedo must be launched/bolted immediately upon the application of the reserve power. Type-F launchers cannot be armed by this method.

**(FP1.94) LOST TORPEDOES:** If energy is not allocated at the start of a turn to continue the arming of a plasma torpedo or to hold that torpedo, the torpedo is lost immediately. Application of reserve power later during the turn cannot restore the torpedo. See (FP1.14).

**EXAMPLE:** Type-S torpedo launcher A receives two points of power on Turn #1 and two points on Turn #2. It receives no allocated points, however, on Turn #3. The uncompleted torpedo is lost immediately and cannot be recovered by allocating reserve power.

**(FP1.95) SUBSEQUENT TURN:** A player cannot allocate reserve power to a launcher to substitute for the holding or arming energy required for the subsequent turn. A player could not allocate reserve power on Turn #2 as a substitute for the allocated power required on Turn #3.

**(FP1.96) RESERVE POWER** can be used, on the last turn of arming (FP1.9), to increase the power of a plasma torpedo. This can never be in excess of the capability of the launcher. For example, a plasma-

S launcher receives two points of power on Turn #4, two points on Turn #5, and three points on Turn #6. This would normally make the torpedo held by the launcher a plasma-G. However, during a later part of Turn #6, the owning player could add reserve power and increase the torpedo to a plasma-S. He could not increase it to a plasma-R because the launcher cannot handle that weapon. A torpedo increased with reserve power during the original arming cycle can be held. See (H7.53).

**(FP1.961)** This could be used to increase a previously held torpedo, but the resulting torpedo cannot be held past the end of that turn.

**(FP1.962)** This procedure cannot be used to increase a plasma-F torpedo, to create a plasma shotgun (FP7.0), or to create an enveloping (FP5.0) version of a plasma torpedo.

**(FP1.963)** Reserve power can be added to a point allocated to begin loading a type-F torpedo in a larger launcher at any time during the first turn of arming. This irrevocably commits the torpedo to be finished either as a two-turn F or as a larger three-turn torpedo within the capability of the launcher, e.g., G, S, or R in a type-R launcher.

## (FP2.0) TYPES OF PLASMA TORPEDOES

There are four types of plasma torpedoes in Basic Set, each of which is described in this section. Other types are in other products.

### (FP2.1) TYPE-R PLASMA TORPEDO

**(FP2.11) GENERAL:** This is the most powerful type of plasma torpedo, causing up to 50 points of damage out to 10 hexes, and with a maximum range of 30 hexes.

**(FP2.12) NON-HOLDABLE:** In the case of ships carrying plasma-R, the weapon cannot be held if it is not fired before the end of the third turn of arming. A starbase (but not a smaller base) armed with a plasma-R could hold it when fully charged.

**(FP2.13) SHIP SIZE:** No unit smaller than size-3 can mount a plasma-R, and relatively few units smaller than size-2 carry it. Those that do (e.g., War Eagle) generally carry few other weapons because of the bulk needed for the plasma-R.

### (FP2.2) TYPE-S PLASMA TORPEDO

**(FP2.21) GENERAL:** This type, known as "S," is an improvement of the plasma-G. Historically, it was available in Y170. In some earlier editions of Star Fleet Battles, this was called the "G-II" torpedo.

**(FP2.22) REFITS:** Many ships with plasma-G were refitted with plasma-S. All ships with such refits are described as such in their rule. No ship has type-S plasma torpedoes prior to Y170 unless a specific exception to this rule is noted in its description.

**(FP2.23) SHIP SIZE:** No unit smaller than size class-3 can be armed with a plasma-S.

### (FP2.3) TYPE-G PLASMA TORPEDO

**(FP2.31) GENERAL:** This was the original Gorn type and is carried by most of their ships. The Romulan KR-class cruiser (a converted D6) carries this type.

**(FP2.32) REFITS:** Most ships with type-G torpedoes had their weapons upgraded to type-S during the General War. See the refit information for each ship.

### (FP2.4) TYPE-F PLASMA TORPEDO

**(FP2.41) GENERAL:** Being the smallest ship-mounted plasma torpedo, the plasma-F has been adapted to a stasis (time-freeze) box firing system. For this reason, the plasma-F costs nothing to hold once fully charged (unless it has been armed in a larger launcher, in which case it costs 1 point to hold). The plasma-F is (in Basic Set) only used by the Romulan K5R, the Orion pirate CR in its optional

weapons mount, and certain bases. In other products, the plasma-F is widely used on ships, fighters, gunboats, etc.

**(FP2.42) FIGHTERS:** Fighters carrying plasma-F torpedoes are unable to arm these weapons themselves. See (J4.86) for reload instructions.

**(FP2.43) FAST PATROL SHIPS:** PFs armed with type-F plasmas can recharge them.

**(FP2.5) PLASMA TORPEDO DATA TABLES**

**(FP2.51) ARMING COST:** The cost of arming a plasma torpedo is as follows:

Type	Turn #1	Turn #2	Turn #3	EPT/SG	Hold Cost
R	2	2	5	10	4
S	2	2	4	8	2
G	2	2	3	6	1
F	1	1	3	NA	0*

\* 1 point if downloaded from a larger launcher.

**(FP2.52) WARHEAD STRENGTH:** This is shown on the Plasma Torpedo Table (FP1.53). As can be seen, a type-R plasma torpedo that has traveled 13 hexes has a strength of 35 damage points.

**(FP2.6) OTHER TYPES OF PLASMA TORPEDOES**

Beyond the four ship-mounted types most commonly used in the game, there are several additional types found in advanced products:

**Plas-D:** Carried by some fighters; see (FP9.0). The type-D is an encapsulated torpedo carried in a canister the size of a drone. It is also carried by some ships on a special plasma rack (FP10.0).

**Plas-M:** An intermediate size between the S and R carried only by certain X-ships.

**Plas-L:** An upgraded type-F which has the warhead size of a type-G but the launcher size of a type-F and which cannot be upgraded to a type-S.

**NOTE:** Types L and M are seldom mentioned in the FP section because they are used only by X-ships; see (F1.3).

**(FP3.0) FIRING ARCS AND LAUNCHERS**

During the Impulse Activity Phase in which a plasma torpedo is launched, the counter for the plasma torpedo is placed on top of the firing ship. The direction that the counter is faced depends on the launcher. There are two types: fixed and swivel.

**(FP3.1) FIXED LAUNCHERS**

**(FP3.11) STANDARD FIXED LAUNCHERS:** This type of launcher is built into the ship. It can fire in one specified direction (usually directly forward) relative to the launching ship (or fighter). The target must be in a 120° arc bisected by (60° to either side of) the direction of the launcher. If the launcher is facing directly ahead, the target must be in the FA firing arc.

If no target is within the valid arc, the torpedo cannot be targeted and must be held or ejected. The counter must be faced in the same direction as the launcher. The firing arc designated for that launcher (e.g., the War Eagle has a Plas-R-FA) is the arc that the target must be in.

**(FP3.12) GORN LAUNCHERS:** Early Gorn CA and CL ships had their torpedo tubes aimed to the side at 60° angles, so that one could track targets in the RF+R arc (launch in direction 6 relative to the

ship) and the other in the LF+L arc (launch in direction 2). See (D2.2) for arc descriptions.

**(FP3.2) SWIVEL MOUNTS**

**(FP3.21) GENERAL:** Some ships have "swivel" tubes allowing their torpedoes to be aimed at targets within a larger arc. Using this system, the torpedo could be fired in any of three directions at a target within a 180° arc. See (D2.34) and (D2.36) for a layout of these firing patterns.

**(FP4.0) PLASMA TORPEDO GUIDANCE**

Plasma torpedoes are self-guiding. Once launched, they do not require the assistance of any ship to find their targets.

See (P2.33) if there is a planet in the scenario.

**(FP4.1) LOCK-ON AT TIME OF LAUNCH**

The firing unit must have a lock-on to the target at the time the weapon is launched. If the firing unit does not have a lock-on to the target, the weapon cannot be fired. Exception; see (D19.22).

**(FP4.2) SELF-GUIDING ABILITY**

Once launched, the plasma torpedo provides its own guidance. It is not necessary for the firing ship (or another ship) to maintain a lock-on while the torpedo is following its target. See also (F3.42).

**(FP4.21) CONTROL:** The ship can retain (and/or transfer) control of a plasma torpedo in order to provide increased ECCM. If control is released by the ship (or broken), the torpedo then assumes its own guidance. See (F3.3), (F3.4), and (F3.5).

**(FP4.22) CEASE TRACKING:** There is no means by which a player can force his torpedo to cease tracking the target. When control is released, the torpedo automatically assumes its own guidance; control cannot thereafter be re-established. See (F3.42).

**(FP4.23) CONDITIONS:** Plasma torpedoes have superior guidance systems to ATG drones. They can maintain their own lock-on within 35 hexes and can track targets in any arc.

Note, however, that plasma torpedoes are still distracted or otherwise affected by wild weasels, EW, cloaks, etc. Plasma torpedoes are not affected by some scout functions that affect drones; see (G24.225) and (G24.233). Plasma torpedoes (except type-D) are not affected by chaff (D11.6). Ballistically launched (F4.0) plasma torpedoes cannot acquire their own targets, but might be launched at ground targets (P2.713).

**(FP4.24) SENSOR RATING:** Plasma torpedoes have an assumed sensor rating of six. This is not reduced by damage.

**(FP4.3) BUILT-IN ECCM**

**(FP4.31) TORPEDO:** All plasma torpedoes are assumed to have three points of ECCM; see (D6.393).

**(FP4.32) LAUNCHER SUPPORT:** If the launching unit (or another friendly unit to whom control of the weapon has been passed) maintains a lock-on while the weapon is following its target, the ECCM power of the controlling unit is added to that of the torpedo (F3.331) when determining if the target's ECM has diverted the torpedo. If no unit maintains external control, no ECCM power can be added.

**(FP4.4) EFFECT OF EW**

Electronic warfare cannot stop a plasma torpedo from being fired, but can reduce its effect when it reaches the target; see (D6.36).

**(FP4.5) CLOAKS**

**(FP4.51) SELF-GUIDING:** A plasma torpedo that is not controlled by another unit will roll for its own attempt to retain lock-on under (G13.334).

**(FP4.52) LAUNCHER GUIDED:** If the plasma torpedo is controlled by an outside unit, the unit rolls to retain a lock-on. If this fails, the torpedo is released from control and can immediately roll for its own attempt to retain lock-on.

ATG drones use a similar procedure; see (FD5.24).

**(FP5.0) ENVELOPING PLASMA TORPEDOES (Advanced)**

The Romulans developed this weapon in Y162. This technology is available to any race possessing the weapons themselves.

**(FP5.1) BASIC RULE**

The enveloping plasma torpedo (EPT) can be fired by plasma-armed ships instead of their regular plasma torpedoes and from the same launcher.

**(FP5.11) TYPES:** Type-G, type-S, and type-R plasma torpedo launchers can launch EPTs. Type-D and type-F plasma torpedo launchers cannot arm or launch EPTs.

**(FP5.12) SPECIFICATION:** A ship loading a plasma torpedo must specify (on the Energy Allocation Form) on the final turn of arming whether it will be fired as a normal or enveloping type; see (FP5.23).

**(FP5.2) ARMING**

The weapon is armed, fired, and operated in the same manner as a standard plasma torpedo, except that it requires twice the normal amount of energy on the final turn of arming, which **MUST** be the turn of launch.

**(FP5.21) STRENGTH:** The warhead strength of an EPT is double that shown on the appropriate chart for the normal torpedo.

**(FP5.22) HOLDING:** An EPT cannot be held (FP1.24). A torpedo armed in a prior turn and held cannot be converted to an EPT. A torpedo held by rolling delay (FP1.223) can be completed as an EPT. See also (FP1.92).

**(FP5.23) DECISION:** The decision to fire a given torpedo as an EPT is made during the Energy Allocation Phase of the turn of firing. This is the only time the energy can be provided; reserve power cannot be used (FP1.92).

The player marks "EPT" on his Energy Allocation Form to note this type of loading. [The fact that double arming energy was paid is not enough; it could also be marked "SG" for shotgun; see (FP7.32).]

**(FP5.24) EFFECTS OF SIZE:** The torpedo is large, resulting in several effects.

**(FP5.241)** Because the warhead strength is higher, it will take more phaser damage (FP1.6) to destroy an EPT than a standard torpedo.

**(FP5.242)** The torpedo will be immediately recognized as an EPT due to the higher warhead size; see (FP1.32).

**(FP5.243)** The torpedo can be bolted, but the extra energy provided for EPT arming (over and above standard arming) is lost; see (FP8.22).

**(FP5.3) IMPACT PROCEDURE**

Upon reaching its target, the EPT "envelopes" it and implodes, causing damage to all six shields equally. For ground bases, see (P2.7331).

**(FP5.31) BASIC PROCEDURE:** Subtract General Reinforcement (shield points, not energy points) (FP5.35) from the warhead strength

and divide the remainder by six. [Divide by two in the case of Interceptors; (K3.4).] Round fractions down. This is the number of damage points that are immediately applied to all shields. [The specific reinforcement on each shield will of course be used first; see (D3.342).] The remaining points (from rounding) are then scored on shields of the (target) owner's choice, but no more than one point per shield.

**(FP5.32) SEQUENCE:** EPTs strike with other seeking weapons but are treated as a separate "volley." Penetrating hits from any or all of the six shields are resolved internally as a single volley due to the near simultaneity of the implosion. All EPTs which strike during a given impulse are resolved as a single volley.

Treat any phaser which can fire through a down shield as vulnerable to destruction under (D4.321).

**(FP5.33) ANDROMEDANS:** See (D10.14) in Module C2 for the procedure. Generally, the power is divided equally between the PA panel groups. Players without Module C2 can ignore all references to the Andromedans. Should you later acquire module C2, all of the necessary references and exceptions dealing with them will already be in your rulebook waiting for them.

**(FP5.34) NO SHIELDS:** If the target has no shields, simply resolve the warhead strength (not divided by 6) as a single volley without the phaser restriction (D4.321). Note that if the target has general shield reinforcement (D3.341) up, the strength of this must be subtracted from the EPT's warhead before calculating internal damage.

**(FP5.35) GENERAL REINFORCEMENT:** Any general reinforcement (D3.341) allocated (the points produced by the power allocated, not the power itself) by the target ship is subtracted from the weapon's warhead strength before it is divided.

**(FP5.36) MONSTERS:** Living monsters and size-class 0 monsters cannot be enveloped. EPTs are treated as standard torpedoes against these units. Any exceptions will be specifically noted in the appropriate rules.

**(FP6.0) PSEUDO-PLASMA TORPEDOES (Advanced)**

Due to the slow firing rate of plasma torpedoes, the pseudo-plasma torpedo (PPT) was developed by the Romulans to improve the flexibility of the weapon. (Other plasma-using races copied it almost immediately.)

This device simulates a plasma torpedo, making it more difficult to time attacks on a plasma-armed ship to the rearming cycle. All plasma torpedo launchers have PPTs except as noted in the rules. PPTs (and wild weasels) have existed for very nearly as long as plasma torpedoes.

**(FP6.1) DEFINITION**

**(FP6.11) GENERAL:** The pseudo-plasma torpedo is a "fake" plasma torpedo. All F, G, S, and R torpedo launchers have one PPT in a special launch tube near the plasma launcher. PPTs are always available, unless the ship was "surprised" (D18.12) or used the PPT in an earlier battle in a campaign which defines that there was not sufficient time to reload expended PPTs.

There are no type-D PPTs; see (FP9.13).

**(FP6.12) LAUNCH:** The PPT can be launched for no energy cost at any point in the Sequence of Play and under any conditions at which a real torpedo could be fired, assuming that the conjectural real torpedo was armed.

**(FP6.13) CONDITIONS:** It is not necessary to have a real torpedo armed in the tube to fire the pseudo torpedo. A ship that had been so heavily damaged that it could not arm a torpedo could still fire a pseudo plasma torpedo, assuming that it had such a torpedo available and that other conditions for torpedo launch were met.

**(FP6.14) FIGHTERS** armed with plasma torpedoes never have PPTs.

**(FP6.15) PFs:** Most PFs armed with plasma torpedoes have fewer PPTs than they do torpedo launchers. The ship description for each PF class defines these.

**(FP6.2) FIRING RATE**

**(FP6.21) FIRING LIMIT:** Only one PPT may be fired per launcher during a given scenario.

**(FP6.22) SIMULTANEOUS:** A PPT may not be fired during the same impulse as a real torpedo from the same launcher.

**(FP6.23) TYPE:** The PPT can only simulate the largest non-EPT torpedo the launcher is capable of launching.

**(FP6.24) SPECIAL COMBAT RULE:** The PPT can be fired after the launcher is destroyed (FP1.7) under the same conditions as a real torpedo.

**(FP6.3) OPERATIONS**

The PPT moves on the board, follows its target, absorbs phaser damage, etc., and operates in all ways as a plasma torpedo, except that upon reaching its target it does not explode but simply disintegrates (doing no damage to the target or anything else). The obvious function of a PPT is to make engaging a plasma-armed ship more challenging since it introduces some uncertainty as to just what has been launched and how soon another torpedo could be ready.

**(FP6.31) IMPACT:** The impact of a PPT on its target [which may not be the original target; see (FP1.81)] reveals that it is not a real torpedo (i.e., the damage points from the warhead strength are not scored). Even if one or more PPTs and one or more real plasma torpedoes hit the same target at the same time, the owner must reveal which was a PPT and which was a real torpedo.

**(FP6.32) WEB:** A PPT is not exposed when it enters a web (G10.0). It acts exactly as a real torpedo would.

**(FP6.33) LIMITATIONS:** A PPT cannot simulate an enveloping plasma torpedo (FP5.0) or shotgun (FP7.0).

**(FP6.34) DECEPTION:** The PPT is a deception weapon, and any number of tactical papers have been written expounding on how to exploit this. Most players who fire phasers at a plasma torp will avoid reducing it to zero so that it will impact and the minimal damage will reveal its status. Some players will use phasers to destroy their own weak "torpedo" before it hits, to avoid letting the enemy know if it was real or a PPT. Some players will launch PPTs into open space, in an attempt to lure an enemy into range by making him think the torpedo tubes are empty.

**(FP7.0) PLASMA SHOTGUN (Advanced)**

Gorn scientists, seeking a solution to the tactical problems created by a plasma-armed ship (with its slow firing rate) engaging fighters (which the Romulans deployed in Y165), developed the "plasma shotgun" system in Y168. Other plasma-using races duplicated the technology in Y169. The system is devastating to a fighter squadron. It is also useful in fleet actions when engaging several ships.

**(FP7.1) DESIGNATION**

Using this system, any torpedo larger than a type-F can fire a number of type-F torpedoes simultaneously.

BASIC TYPE	NUMBER OF TYPE-Fs PRODUCED
R	5
S	3
G	2

Essentially the ball of plasma energy in the launch tube is divided into smaller pieces to allow more targets to be engaged. The additional arming energy is used to build magnetic fields inside the arming chamber to sub-divide the torpedo into several smaller ones.

**(FP7.2) OPERATION**

**(FP7.21) SIMULTANEOUS LAUNCH:** All of the type-Fs must be fired on the same impulse and with the same facing.

**(FP7.22) SEPARATE TARGETS:** Each type-F must have a separate target, and those targets must all be within the tracking arc of the launcher. If there are not enough targets for all of the type-Fs, the excess are removed from play or can be given ballistic courses (F4.0) for deception purposes.

**(FP7.23) TWO LAUNCHERS:** A given ship cannot fire two plasma launchers in the same impulse if one of them is a shotgun type.

**(FP7.24) BOLTS:** A plasma launcher loaded as a shotgun can be bolted, but the separate torpedoes will fuse back into a single torpedo of the original size; see (FP8.24). The excess energy (used to build the magnetic divisions) is lost.

**(FP7.3) ARMING**

**(FP7.31) DECISION:** The decision to fire a plasma charge as a shotgun instead of a single torpedo is made during the Energy Allocation Phase of the last turn of arming. A torpedo can be completed as a standard, enveloping, or shotgun type, but cannot be simultaneously completed as both an enveloping AND a shotgun type.

**(FP7.32) ENERGY:** The energy cost for the last turn of arming is double the normal cost. (Example: A type-G plasma torpedo normally costs 2-2-3 to arm; as a shotgun it would cost 2-2-6.) The player marks "SG" on his EAF to note this type of loading.

**(FP7.33) HELD TORPEDO:** A completed plasma torpedo held from a previous turn cannot be converted to a shotgun load. A torpedo held by rolling delay (FP1.223) can be completed as a shotgun.

**(FP7.34) RESERVE POWER:** A plasma torpedo being held by rolling delay cannot be completed as a shotgun type with reserve power; see (FP1.92).

**(FP7.4) RESTRICTIONS**

**(FP7.41) HOLDING:** A launcher loaded as a shotgun cannot be held.

**(FP7.42) CONVERSION:** A launcher loaded as a shotgun cannot be converted back to normal or into an enveloping plasma torpedo.

**(FP7.43) PSEUDO-PLASMA:** PPTs are pre-loaded and cannot simulate shotgun launches.

**(FP7.44) TYPE-F ONLY:** Division into type-F plasma torpedoes is the only means of dividing a plasma torpedo. For example, a type-R cannot be shotgunned into a type-G and a type-S.

**(FP7.45) SENSOR BLINDING:** The launch of a plasma shotgun will blind special sensors (G24.13), but only one sensor is blinded for each launcher which fires a shotgun (not one per component type-F).

**(FP8.0) PLASMA BOLTS**

Plasma torpedo launchers can be fired, within certain restrictions, as direct-fire weapons (plasma bolts), rather than as launchers for seeking weapons. This procedure is less efficient, but has certain tactical advantages. The electro-mechanical procedure for firing in this mode is to detonate the torpedo in the launch tube and release the energy in a specific direction. The plasma bolt is an inefficient weapon, but provides tactical options that make the seeking torpedoes more usable.

**(FP8.1) AVAILABILITY**

**(FP8.11) USE:** All plasma torpedo launchers except those noted in (FP8.2), during all time periods, can be used to fire plasma bolts.

**(FP8.12) AVAILABILITY:** Using a given launcher in either mode (seeking or bolt) does not restrict its future use (even within the same scenario) in the other mode.

**(FP8.2) RESTRICTIONS**

Certain types of plasma torpedoes cannot be used as plasma bolts due to the nature of their operations.

**(FP8.21) PSEUDO PLASMA TORPEDOES** (FP6.0) cannot be used as plasma bolts because they are not energy-based weapons, but fixed-rounds stored in advance. Besides which, as no deception is possible, there would be no benefit to doing so.

**(FP8.22) ENVELOPING PLASMA TORPEDOES** (FP5.0) do not have increased effects when used as plasma bolts. If a launcher, previously loaded as an enveloping plasma torpedo, is fired as a bolt, it is treated as a normal non-enveloping torpedo. The extra arming energy is lost. If the torpedo had been downloaded (e.g., a plasma-R launcher downloaded with an enveloping type-G), the extra energy for an EPT is lost and the bolt is type-G, not type-R. (Some might argue that since enough total power was applied to arm a standard torpedo of the large type, the bolt should be of that type. This is not true because the extra energy is being used for other purposes than pure strength.)

**(FP8.23) FIGHTERS:** The type-F and type-D plasma torpedoes carried by fighters (J4.86) cannot be fired as bolts. The small frame of the fighter could not stand the shock. Note that this rule includes plasma-armed MRS shuttles.

**(FP8.24) SHOTGUN:** If a torpedo, previously armed as a plasma shotgun (FP7.0), is fired as a bolt, the individual elements will simply fuse into a single torpedo of the normal (G, S, R) type, which is then bolted normally (i.e., at 50% of the strength for the given range). If the torpedo had been downloaded (e.g., a plasma-R launcher downloaded with a shotgun type-G, that is two type-Fs), the extra energy for a shotgun is lost and the bolt is type-G, not type-R. (Some might argue that, since enough total power was applied to arm a standard torpedo of the large type, the bolt should be of that type. This is not true because the extra energy is being used for other purposes than pure strength, in this case to section the arming chamber.)

**(FP8.25) DESTROYED LAUNCHERS:** Plasma bolts cannot be fired from destroyed launchers. Torpedoes held in destroyed launchers may (FP1.7) be launched as seeking weapons up to 8 impulses later. When the launcher is destroyed, the torpedo is still held in the magnetic bottle contained within the launcher. Without the physical structure, the bottle will collapse within that time. The magnetic bottle, however, is too weak to withstand the detonation of the torpedo, so it cannot be bolted.

**(FP8.26) FAST PATROL SHIPS:** Plasma-armed PFs cannot fire more than one torpedo as a bolt during any given turn. This is included in the normal two torpedoes per turn firing rate, allowing a typical PF to fire one bolt and one seeking torpedo, or two seeking torpedoes, within a turn.

The limit of one bolted torpedo per PF per turn includes any type-D torpedoes except those fired in defensive mode (FP10.212) against targets of size-6 or smaller.

**(FP8.3) OPERATION**

**(FP8.31) DIRECT-FIRE WEAPONS** The plasma bolt operates as any other direct-fire weapon. It is declared and resolved in the Direct-Fire Weapons Stage 6D2, cannot be distracted as seeking weapons can (WW, scout), and cannot be intercepted or reduced by weapons fire on the torpedo/beam itself.

**(FP8.32) ELECTRONIC WARFARE:** The effect of electronic warfare on a plasma bolt is resolved as with any other direct-fire weapon. The net ECM shifts are added to the die roll, increasing the possibility of a miss. Plasma bolts are not seeking weapons and are not treated as such. Torpedoes fired as plasma bolts do not have the built-in ECCM of seeking torpedoes.

**(FP8.33) PROCEDURE** To be fired as a plasma bolt, the plasma torpedo launcher must be fully charged and ready to fire. The decision to fire a plasma torpedo in either seeking or direct mode is made at the instant of launch/firing. If the launcher is armed by reserve power, it must launch a torpedo or fire a bolt on that turn.

**(FP8.331)** Direct-fire weapons are fired and seeking weapons are launched at different points in the Sequence of Play. If the game has reached the Plasma Torpedo Launch Step and the player decides to fire the weapon as a plasma bolt, he must wait for the Direct-Fire Stage 6D2. If in the Direct-Fire Stage, the player decides to launch as a seeking torpedo, he must wait for the next impulse.

**(FP8.332)** In the case of accelerated arming (FP1.93), once reserve power is applied, the torpedo must immediately be launched or bolted.

**(FP8.34) OVERLOADS:** There is no overload function for a plasma bolt.

**(FP8.35) FIRING ARCS:** The firing arc of a plasma bolt is generally the same as the tracking arc for the corresponding plasma torpedo. However, arcs for swivel launchers are limited for bolt purposes as follows:

TRACKING ARC	LIMITED TO
LP	L+LF
LS	L+LF (LS for plas-D-rack)
FP	FA
RP	RF+R
RS	RF+R (RS for plas-D-rack)
LPR	L+LR
RPR	R+RR
AP	RA

**(FP8.36) FEEDBACK:** If fired in the same hex as the target, the plasma bolt produces feedback damage to the firing ship equal to 25% of the warhead strength of the normal torpedo, as per (FP1.86). Extra energy from an enveloping or shotgun load is ignored for this purpose.

**(FP8.4) COMBAT RESOLUTION**

The effect of a plasma bolt is resolved as follows:

**(FP8.41) STEP A:** The owning player indicates his intention to fire a given plasma torpedo as a plasma bolt. He designates the firing ship and the target. See (E1.612) for narrow salvos.

**NOTE:** If using (D17.0) Tactical Intelligence, the specific weapon fired might not be revealed at some ranges.

**(FP8.42) STEP B:** The probability of a hit is based on the effective range to the target and is given here. The hit probabilities are shown as a "Bolt" line on the plasma torpedo charts on SSDs.

RANGE	0-5	6-10	11-20	21-31
HIT	1-4	1-3	1-2	1
MISS	5-6	4-6	3-6	2-6

**(FP8.43) STEP C:** The amount of damage scored (if the torpedo hits) is equal to one-half of the warhead strength of the corresponding plasma torpedo (S-bolt = S-torpedo) at the true range to the target. Retain fractions throughout the calculation, then drop all remaining fractions before applying any damage. Bolts, even those in narrow salvos, cannot be combined to avoid losing fractional warhead points.

**SYNOPSIS OF PLASMA TORPEDO RULES IN STAR FLEET BATTLES ADVANCED MISSIONS**

To aid in later integration of Basic Set with a whole range of advanced and expansion products, the Basic Set rules are filled with numerous cross-references to the rules from those other products. Of course, if you do not have a given product, then any rules from that product cannot be used; they do not impose any penalties or provide any benefits to the player. To aid in understanding the Basic Set rules, and to prevent confusion over these references to rules in other products, the following synopsis of these rules is provided.

**(FP9.0) TYPE-D PLASMA TORPEDO:** The type-D torpedo is about half the strength of a type-F. It is contained in a fixed canister the size and shape of a drone, allowing it to be carried on fighters. (For example, the Gorn G-18 fighter is a license-built copy of the Federation F-18. Where the F-18 carries drones, the G-18 carries plasma-Ds.) The capsule must be activated with a small amount of energy before the torpedo can be fired.

**(FP10.0) PLASMA RACK:** The plasma rack is used by ships to fire type-D plasma torpedoes. It operates in a fashion similar to a drone rack, but has offensive and defensive modes. It can fire faster in defensive mode, but only against small targets. Many Gorn and Romulan carrier escorts use plasma racks, resulting in escorts as powerful as standard warships.

**END OF SECTION (FP0.0) BASIC SET**



**(G0.0) SYSTEMS****(G1.0) GENERAL RULES**

Ships include many systems (primarily electronic) which are used to perform the assigned tasks. Most systems are defined in this section; weapons and certain other systems are defined separately.

**(G2.0) CONTROL SYSTEMS**

Each ship contains several control systems. These represent the ability of the captain to control his ship. If all control systems are inoperable (destroyed), then the ship is considered to be "uncontrolled;" see (G2.2).

**(G2.1) DEFINITION**

**(G2.11) GENERAL:** The following systems are control systems: bridge, emergency bridge, auxiliary control, and flag bridge. These are within the general category of "control systems" for purposes of repair cost (Annex #9), emergency damage repair (D14.0), lab substitution (G4.31), etc.

**(G2.12) DAMAGE:** Each damage point allocated to a control system destroys one appropriate box on the SSD.

**(G2.13) SECURITY:** Klingon security stations (G6.1) are considered as control systems for all purposes except actually controlling the ship (G2.2). Security stations are not used to control the ship (they are used to control the crew). The security officers could manage to get the ship home, but could not control it in combat.

**(G2.2) EFFECT OF BEING UNCONTROLLED**

**(G2.20) BECOMING UNCONTROLLED:** If all control systems (excluding security) on the ship are destroyed (or have been captured by enemy boarding parties), the following restrictions apply to the ship on the turn following the destruction/capture of the last control box and on all subsequent turns. If a control box is repaired or recaptured, the restrictions are removed at the end of the turn during which this happens.

**NOTE:** See (G9.44) if the ship is also "undermanned."

**(G2.21) MANEUVERING** by an uncontrolled ship is restricted. These restrictions can only take effect at the start of a turn.

**(G2.211)** The turn mode is increased to the next higher category (B to C, etc.).

**(G2.212)** The ship cannot:

- make high energy turns (C6.0),
- make quick reverses (C3.6),
- change speed in mid-turn (C12.0),
- use EM (C10.0), or
- perform emergency deceleration (C8.0).

**(G2.213)** If the ship attempts to land on a planet by any procedure except a crash landing, roll one die at the point when the ship actually lands. If the result is 1-3, proceed normally; otherwise treat it as a crash landing (P2.431).

**(G2.22) TACTICAL MANEUVERS** (C5.0) are allowed only in the last half of any given turn (after half of the impulses have elapsed). Tacs in the first half (Impulses #1-#16) of the turn (and the energy paid for them) are lost. If under these restrictions, the ship allocates power for tactical maneuvers as usual, but loses any such maneuvers (and the energy allocated for them) earned or scheduled to take place in the first half of the turn. The one allowed impulse (sublight) tactical maneuver cannot be lost. Crippled ships do not have to pay (in subsequent Energy Allocation Phases) for TACs on the first half of a turn when they would not be able to use them.

**(G2.23) COMBAT:** The ship may fire weapons normally at only one target in any given turn; this fire must be in a single impulse. All other

use of direct-fire weapons is considered to be under the "disrupted fire control" provisions of (D6.68).

**(G2.231)** ADDs (E5.0) operate with an automatic and autonomous tracking system and are not affected by being uncontrolled. This includes G-racks in ADD mode. This does not include type-VI drones launched from an ADD or G-rack.

**(G2.232)** A PPD (E11.0) would fire for only one pulse, the others being lost. A PPD continuing fire from a previous turn would fire only on the first impulse. This is regardless of the target type.

**(G2.233)** A web caster (E12.0) could place web only in a single hex. This would be limited to five hexes range unless it was the "one target" engaged with normal fire.

**(G2.234)** The ship can only control seeking weapons equal to half of its sensor rating (round fractions up). The ship can only launch seeking weapons during one impulse of the turn and can guide them to only one target (the same target as direct-fire weapons).

**(G2.24) SYSTEMS:** The ship may not:

- use tractor beams (G7.0),
- use labs to identify seeking weapons (G4.2),
- use ECCM (D6.3),
- launch wild weasels (J3.0),
- use any scout functions (G24.0),
- or lay, control, detect, or sweep mines (M0.0).

The ship can use negative tractor power (G7.35). It uses transporters (G8.0) normally. This rule creates an exception to (D6.681).

**(G2.25) FIRE CONTROL:** The ship may not use:

- Aegis (D13.0) or limited aegis fire control,
- DERFACS (E3.62) fire control, or
- UIM (D6.5) fire control.

It may use Passive Fire Control (D19.0) and Low Powered Fire Control (D6.7). Its fire control can still be Disrupted (D6.68).

**(G2.26) SPECIAL WEAPONS:** The ship may not use stasis field generators (G16.0) or displacement devices (G18.0). Temporal Elevators (G31.0) cannot be used, and cease to function, if the base is uncontrolled.

**(G2.27) FLYWHEEL:** The ship cannot benefit from or use a positron flywheel (C9.0).

**(G3.0) HULL****(G3.1) DEFINITION**

**(G3.11) GENERAL:** The various boxes marked "hull" represent various non-critical parts of the ship. These include such things as crew quarters, gymnasiums, bowling alleys, storage, swimming pools, machine shops, libraries, etc. While damage in these areas is not particularly desirable, it does not materially affect the ship's ability to participate in combat. (They can be repaired later, after the crisis has passed.) In practice, hull hits are "free" hits (i.e., damage that doesn't hurt).

**(G3.12) OTHER SYSTEMS DESTROYED BY HULL HITS:** Repair (G17.25) and barracks (G28.2) are destroyed on "hull" hits; see Annex #7E.

**(G3.2) CLASSIFICATION**

Hull is divided into three types as described here. See (D4.351) for instructions on scoring damage on the various types of hull.

**(G3.21) FORWARD HULL:** This is marked F HULL on SSDs. Some SSDs have "HULL" over a group of boxes with an "F" in one box. Forward Hull boxes are destroyed only on "F Hull" damage points.

**(G3.22) AFT OR REAR HULL:** Aft Hull (also known as Rear Hull). This is marked A HULL or AFT HULL on SSDs. Some are marked R HULL or REAR HULL. Some have HULL over the group of boxes with an "R" in one box. The terms Aft Hull and Rear Hull are interchangeable. Aft Hull boxes are destroyed only on "A Hull" damage points.

**(G3.23) CENTER HULL:** Some ships have a third type of hull, while others have all of their hull boxes combined into a single type. This is simply marked HULL or sometimes C HULL on the SSD.

**EXAMPLES:** The Gorn Heavy Cruiser has all three hull types. The Tholian PC has only Center Hull.

**(G4.0) LABS**

The laboratory boxes indicate the ability of the ship to conduct scientific experiments and gather information. In the "monster" scenarios, these labs can sometimes be used to gain victory points, e.g., (SM2.46). In combat with other ships, however, they in effect become just free hits; exceptions, see:

- (G4.2) Identification of seeking weapons,
- (D14.0) Emergency damage control, and
- (D17.228) Tactical Intelligence.

Labs do not require active fire control or a lock-on to function. Range is unaffected by which type of fire control is in use.

**(G4.1) SCIENTIFIC RESEARCH**

The primary operation of labs in scenarios is the scientific investigation of an object or "target," which may be a monster, unit, object, or location specified by a scenario. In general combat, scientific information has no function. This rule is used only if the scenario calls for scientific information to be gained about a specific item.

**(G4.11) CHART:** The chart below is used to determine the amount of information gained about the object of study on each turn. During each turn, the player should record the closest approach of his ship to the object. The chart is based on the distance from the object at closest approach (during that turn).

DIE ROLL	RANGE										
	0	1	2	3	4	5	6	7	8	9	10
1	10	9	8	7	6	5	4	3	2	1	0
2	9	8	7	6	5	4	3	2	1	0	0
3	8	7	6	5	4	3	2	1	0	0	0
4	7	6	5	4	3	2	1	0	0	0	0
5	6	5	4	3	2	1	0	0	0	0	0
6	5	4	3	2	1	0	0	0	0	0	0

**(G4.12) PROCEDURE:** At the end of each turn, the player must determine how much information he has gained about the monster. This is determined using the chart above. Noting the range at his closest approach to the monster and rolling a single die, the player obtains a result from the chart. This number, multiplied by the number of functioning lab boxes on his SSD at the end of the turn, is the amount of scientific information gathered about the monster. This procedure is not affected by electronic warfare (D6.3).

See (G4.43) for cloaked ships, and (C10.52) for ships using EM. See (G24.27) for using labs in conjunction with scout sensors.

**(G4.13) OTHER INFORMATION SOURCES:** Administrative shuttles (J2.212), EW fighters (R1.F7), and probes (G5.2) may assist in obtaining (G4.1) information (only). These gather information based on their range to the target (and with their own die roll), which is presumably closer than the ship. Labs can be used in conjunction with scout sensors (G24.27) for enhanced information gathering.

The term "administrative shuttles" includes (for purposes of this rule) manned MSS, manned MLS, and GAS shuttles. This rule also covers manned MRS and SWAC shuttles, and manned fighters with sensor pods (J11.42).

**(G4.2) IDENTIFYING SEEKING WEAPONS WITH LABS (Advanced)**

Labs can, to a limited extent, obtain certain information about seeking weapons near the ship. See (M7.51) for identifying mines.

**(G4.21) LIMITATION:** Each lab box on board a ship, if it (the lab) is undertaking no other action on that turn, can make one attempt to identify a seeking weapon. This procedure can be used while the ship is under wild weasel restrictions (J3.13), but cannot be used by a cloaked ship (G13.56) or one using erratic maneuvers (C10.52).

**(G4.22) PROCEDURE:** The player owning the ship rolls a single die, and if the result is greater than the range from the ship to the seeking weapon, then the attempt is successful and the player controlling the seeking weapon must identify it as per (G4.23).

**(G4.23) INFORMATION GAINED:** A successful lab attempt to identify a seeking weapon reveals the following information. See (F1.4) for other means of gaining similar information. See (G24.25) for using labs in conjunction with scout channels.

**(G4.231) DRONES:** The player controlling the drone must reveal its exact type (including all modules, speed, ATG if present, and endurance) and its target. The lab will also reveal armor and previous damage. When identifying the target, if the weapon is on a ballistic course (F4.0) this is revealed but the precise target hex is not. A null module (FD10.48) will be reported as an explosive module.

**(G4.232) PLASMA TORPEDOES:** Labs can only reveal the target of a plasma torpedo; this is revealed by the player controlling the torpedo. They cannot distinguish between plasma torpedoes and pseudo-plasma torpedoes. Note the strength of the torpedo is always known [(FP1.32) and (FP5.242)] and therefore whether or not it is enveloping without using labs. Labs cannot determine if a given torpedo was originally part of a shotgun load (FP7.0).

**(G4.233) SHUTTLES** can also be identified by labs. A successful attempt reveals if the shuttle is manned or unmanned and if it is following a seeking course (seeking weapon, not pursuit plotting), but not if it is carrying drones or a suicide bomb. It will reveal the target of a seeking shuttle as if it were a drone (G4.231). Note that a stationary shuttle will list its targeting even if it is not moving.

**(G4.24) AEGIS:** The Aegis systems uses the same rules as the laboratory procedure for the information gained, but uses (D13.31) to determine if the information is gained or not.

**(G4.3) LAB SUBSTITUTIONS**

**(G4.31) CONTROL SPACE:** A ship without labs, including ships that lost them in combat or never had them, can use one of its control spaces (G2.11) as a lab. This does not interfere with its ability to function as a control system.

If a lab is recaptured or repaired, it assumes the lab function at the start of the next turn (and the control box loses its lab capability).

No more than one control space can be used per turn.

This substitution can be used if all undestroyed lab boxes have been captured by enemy boarding parties; see (D16.0).

**(G4.32) ACTIVATION:** The transfer of function takes place at the end of the turn on which the last actual lab box is destroyed or captured.

**(G4.33) EMERGENCY REPAIRS:** One (and no more than one) control space can be used as a lab for emergency damage repair (D14.0), and only after all labs have been destroyed.

**(G4.4) OTHER LAB FUNCTIONS**

**(G4.41) EMERGENCY REPAIRS:** Labs can be used for emergency damage repair (EDR), see (D14.0).

**(G4.42) PLANETARY STUDIES:** Some scenarios may require a ship to gain scientific information on a planet (or ship or other object). This uses the procedures in (G4.1).

**(G4.43) CLOAKED SHIPS** cannot use labs to detect or study anything outside of the ship (G13.56), but can use them for EDR (D14.0).

**(G4.44) POWER:** Labs do not require power for scientific research or for identifying seeking weapons. They require power for EDR (D14.12). No power is needed for TacIntel (D17.228).

**(G4.45) CYCLE:** The standard quarter-turn delay between using a system twice (once in each of two subsequent turns) applies to labs. This applies even if the lab is used for different functions on subsequent turns.

**(G4.451)** Scientific research, tactical intelligence, and seeking weapon identification are tied to a specific impulse. If a lab is used for any of these functions during the last 8 impulses of a turn, that same lab cannot be used for any of those functions during the first impulses of the next turn (due to the 8 impulse delay).

**(G4.452)** Emergency damage repair (D14.0) takes the entire turn. If used for EDR on one turn, it cannot be used for (G4.451) during the first 8 impulses of the next turn. However, even if the lab is used for (G4.452) during the last 8 impulses of one turn, it can be used for EDR on the next turn.

## (G5.0) PROBES

Probes are instrument packages used to gather scientific information. Probes can be used against certain types of space monsters, such as the Space Amoeba (SM2.0), or as emergency weapons. The "probe" results in (S6.0) are resolved as (G5.3). In most cases, the probe box on the SSD is just another free hit.

### (G5.1) GENERAL RULES

**(G5.11) RANGE:** Probes have a maximum range of six hexes. This range is reduced in a nebula (P6.72).

**(G5.12) AMMUNITION:** Unless specifically stated otherwise in the ship description or shown on the SSD, all probe launchers carry five probes. Extra probes (up to 5) can be purchased under (S3.2); these can be reloaded by (FD2.42).

**(G5.13) SSD:** Each probe box on the SSD represents one probe launcher. Most ships have one probe launcher. A few ships, mostly survey cruisers, have two probe launchers. A few ships, mostly small civilian types, do not have a probe launcher.

**(G5.14) FIRING ARC:** When launched to gain information, the probe has a 360° firing arc. If fired as an emergency weapon, see (G5.33).

### (G5.2) INFORMATION

The primary function of probes is to gain scientific information about specific objects of interest or study. Probes can be used to gain information on enemy units (G5.24) and seeking weapons (G5.25).

**(G5.21) ARMING:** Probes launched for informational purposes must be armed. Arming costs one unit of energy (any type) for two consecutive turns. The second turn of charging may be the turn of launching. Only one probe may be armed or launched at a time for each launcher on the ship. If not launched during the second turn of arming, the first turn of arming is lost and the second turn of arming is considered to be the first turn of a new two-turn cycle. See (H7.42) to begin arming as a weapon with reserve power. Reserve power can also be used to arm scientific and tactical intelligence probes. Probes may not be armed prior to the beginning of a scenario unless allowed by Special Scenario Rules.

**(G5.22) PROCEDURE:** The ship using the probe must be within 6 hexes of the "object of study." The probe, when fired, moves immediately to any hex which is: within six hexes of the launching ship, in the same hex as or in a hex adjacent to the object of study, and to which there is a direct path (between the ship and the hex) which is clear of blocking terrain (webs, ESG fields, planetary surfaces, black holes, pulsars). Asteroids, small moons, and various zones are not blocking terrain. The probe then produces 20 points of "Information" (G4.1) about the object of study.

**(G5.23) OPERATIONS:** Probes launched for information cannot be fired at, displaced, placed in stasis, moved by transporter, or held in a tractor beam. Probes launched for information or tactical intelligence cannot cross an ESG (G23.86) or web (G10.65). See (G5.37) for an interesting difference between scientific and weapon probes. Probes fired into a nebula have a reduced range (P6.72).

**(G5.24) TACTICAL INTELLIGENCE:** In the case of probes used to identify enemy ships, see (D17.15), which uses a slightly different procedure.

**(G5.25) SEEKING WEAPONS AND SHUTTLES:** A probe fired at a seeking weapon or shuttle will provide the same information as a successful lab identification (G4.23). The probe must use the procedure from (G5.22) to gain this information.

### (G5.3) EMERGENCY WEAPONS

Probes may be launched at ships or monsters as anti-matter bombs. While the probe launcher could be used as such (using the procedure below), it is intended for use as a scientific tool. It can only be fired or armed as a weapon if one (or more) of the following conditions are met.

1. If the ship is crippled.
2. If the enemy forces outnumber the friendly forces in the current scenario by 50% of their combat BPV (based on the current situation).
3. If directed to use it by the scenario.
4. If all players agree before the scenario begins (or if local tournament rules establish) that probes may be fired as weapons at any time.
5. If the ship is commanded by a legendary captain (G22.221) or manned by an outstanding crew (G21.215). Similarly, a poor crew (G21.115) can never use a probe as a weapon.

**(G5.31) COMBAT:** Anti-matter probes have a warhead strength of 8 and are considered a direct-fire weapon. There is no overload function. There is no feedback damage.

**(G5.32) ARMING:** Anti-matter probes are armed by allocating two units of warp energy on two consecutive turns; the weapon MUST be launched (or discharged) on the second turn; it cannot be held. If energy is not allocated on the second turn, arming is aborted and the energy allocated on the first turn is lost. The same probe could be armed again, or used as a scientific device, on a later turn. Energy must come from warp sources (H2.0) or (H2.3).

Arming can begin with reserve power (H7.53), but a probe cannot be fired within 8 impulses of the point at which arming began. A probe launcher cannot begin arming with reserve power on the turn on which it was fired (for information or as a weapon).

Each probe launcher may arm only one anti-matter probe at a time. While the launch is doing this, it cannot also arm or fire a probe for informational purposes.

**(G5.33) FIRING ARC:** While informational probes may be launched in any direction, anti-matter bombs may only be fired directly ahead (in the row of hexes extending directly ahead of the ship). There are two exceptions.

**(G5.331)** A probe on a base can be fired (as a weapon) in any direction; it is not restricted to the straight hex rows. This is a true 360° firing arc.

**(G5.332)** Ships using directed turn modes (C3.8) could use the alternative firing arcs below:

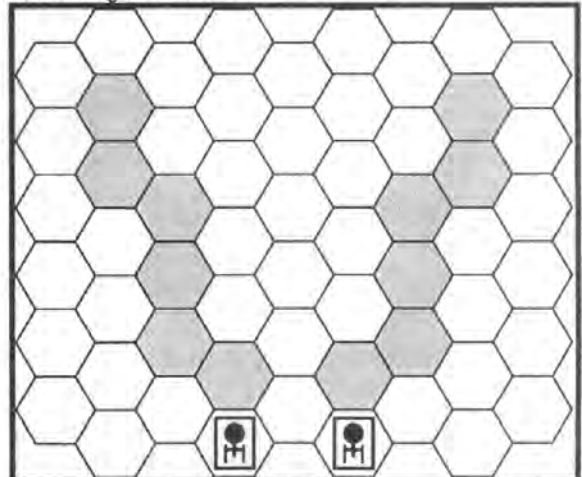

**(G5.34) HIT:** To determine if the probe has hit its target, roll a single die. If the result is greater than or equal to the range from the ship to the target, the probe has scored a hit. The probe can be fired at a range of zero.

**(G5.35) WEAPON FUNCTIONS:** There is no overload, mine, or proximity function for this "weapon."

**(G5.36) MULTIPLE LAUNCHERS:** If a ship has two or more probe launchers, the use of one of them as a weapon has no effect on the others.

**(G5.37) ESG:** Probes fired as weapons can pass through an ESG (G23.86).

**(G5.38) WEAPON STATUS:** Probes may never be armed as weapons before the scenario begins, regardless of weapons status, unless specifically exempted from this rule in a scenario.

## (G6.0) SECURITY STATIONS AND KLINGON MUTINY *Advanced Rule*

Unlike other ships in the game, Klingon starships include in their crews numerous individuals of "subject races." Normally over half the crew is composed of such individuals. While most of the "subjects" are not slaves, they are considered to be "politically undependable," and the security stations on each ship keep a constant watch on these crewmen. The security stations also watch the Klingon officers and crew for signs of weakness, cowardice, or treason.

The security stations are manned by the Empire Security Service, members of which are not naval personnel and are not under the direct control of the captain.

### (G6.1) SECURITY STATIONS

**(G6.11) SSD:** Most Klingon ships have two security stations, each represented by one or two boxes on the SSD. Some ships have only one, and a very few have three or more.

**(G6.12) DAMAGE:** Hits designated by the DAMAGE ALLOCATION CHART as "flag bridge" hits will be scored against the security stations of a Klingon ship. For this reason, no Klingon ship has a "flag bridge." The flag bridges on Klingon ships are merged with the regular bridges for SSD purposes, which is appropriate because Klingon admirals and commodores are expected to command their flagships as captain during combat. See Annex #7E.

Exception: Diplomatic ships (e.g., D7N and D5N) have flag bridges.

**(G6.13) EFFECT ON BOARDING PARTY COMBAT:** Security stations give Klingon ships an advantage in boarding party combat; see (D7.422)-Step 2A.

**(G6.14) EXEMPT FROM MUTINY:** Klingon diplomatic ships (e.g., D7N, D5N), PFs, computer-controlled ships (G11.25), and X-ships cannot mutiny. Other ships which cannot mutiny may be designated in their ship descriptions. Ships with poor crews mutiny more often (G21.144); ships with outstanding crews (G21.244) mutiny less often.

None of these mutiny-exempt ships are in Basic Set.

Ships which have already experienced one mutiny (G6.24) cannot mutiny again during the scenario.

### (G6.2) HOW MUTINY CAN OCCUR

If all security stations are destroyed [or captured by enemy boarding parties under (D16.0)], there is a possibility that the crew will mutiny and successfully take control of the ship.

**(G6.20) PROCEDURE:** The possibility of a mutiny is determined by a die roll. When the last security station is knocked out (or captured), a die is rolled immediately to determine if a mutiny has broken out. If it has not, then at the end of that turn, and at the end of all subsequent turns until a mutiny is staged (or a security station is repaired or recaptured), a die must be rolled.

On a die roll of "1," a mutiny has occurred.

When a mutiny occurs, immediately roll a second die to determine if the loyal crewmen have been able to retain control or if the ship has been seized by the mutineers. On a die roll of "1," "2," or "3," the mutiny has been put down. On a die roll of "4," "5," or "6," the mutiny has been successful. Note the option stated in (G6.25).

**(G6.21) MARINES:** While there is nothing to prevent the Klingon player from transferring boarding parties around between his ships, the presence of more or fewer boarding parties has no effect on the chance of a mutiny happening or on its success since the boarding parties themselves are largely non-Klingon troops and would be as likely to mutiny as the crew of the ship.

**(G6.22) ENEMY MARINES:** For every fourth enemy (enemy of the Klingons, not counting mutineers) boarding party on board (not counting those enemy boarding parties conducting "hit-and-run" raids), subtract 1 from the die roll when determining if the mutiny has occurred (a result of less than 1 is considered to be 1) and add 1 to the die roll when determining if it was successful.

**(G6.221)** If the ship is size class 2, this effect is caused by every sixth enemy boarding party.

**(G6.222)** If the ship is size class 4, this effect is caused by every second enemy boarding party. (Size class 5 ships, i.e., PFs, cannot mutiny.)

**(G6.223)** In the case of a starbase, which is size class 1, this effect is caused by every tenth enemy boarding party on board.

**(G6.224)** See (G21.144) in the case of a poor crew, (G21.244) in the case of an outstanding crew, and (G22.53) in the case of a legendary marine major. If both a crew (whether poor or outstanding) and a legendary marine major are aboard the ship, their effects are cumulative on the mutiny die roll (G22.122).

**(G6.23) CONTROL SPACES:** If all control spaces (G2.11) on the ship have been destroyed before a mutiny has been declared, subtract 1 from the die roll when determining if it occurs and add 1 to the die roll when determining if it was successful. This is cumulative with the effects of (G6.22), (G21.144), (G21.244), and (G22.53), i.e., an addition of 1 and a subtraction of 1 would cancel each other out.

**(G6.24) SUBSEQUENT MUTINY:** If the mutiny occurs and is put down, do not roll on subsequent turns for mutiny. Any crewmen who might have tried it are most likely dead.

**(G6.25) BOOM SECTION:** The owning player of the ship has the option, should a mutiny occur, of allowing it to be successful automatically, but retaining positive control of the boom section. See (G6.4) and (G12.0). Assume 1/3 of the crew and boarding parties are in the boom and loyal to the captain (or the senior loyal officer). The decision is made when the mutiny occurs, but before it is rolled for.

If using (D16.0) in Module M, the owning player would have to control the boom section to conduct separation.

### (G6.3) EFFECTS OF A MUTINY

If a mutiny occurs and is successful, the following actions occur.

**(G6.31) DIE ROLLS:** No further mutiny die rolls are made.

**(G6.32) OPERATIONS:** The ship cannot move or fire weapons. The non-Klingon beings among the crew are never taught these skills. If the mutineers seize control during the turn (as opposed to at the end), the ship continues moving for the rest of the impulse procedure but cannot turn, sideslip, or fire. If using plotted movement (C1.32), the ship follows the plot.

Historical Footnote: The Klingon D6 battlecruiser *Destruction*, which was taken over by mutineers in Y170, was able to escape to Federation territory because two Federation spies, trained to operate the helm, were aboard. There is no provision in the current SFB rules for this unique incident.

**(G6.33) SURRENDER:** The "crew" notifies the ships of the opposing player that they wish to surrender. Unless the ship is subsequently recaptured or destroyed, or towed away by the Klingons, the ship is considered to be captured (by the enemies of the Klingons) for victory conditions. See (G6.62).

**(G6.34) POST-MUTINY:** After the mutiny is over (either successfully or unsuccessfully), the winning player (the non-Klingon player would represent the mutineers) rolls a single die for each of the Klingon boarding parties that were on board when the mutiny began. A die roll of 1-3 means that the boarding party in question has survived and joined the winning side. A die roll of 4-6 means that the boarding party was destroyed in the fighting.

Any enemy boarding parties aboard are unaffected. Any Klingon boarding parties from other Klingon ships joined the mutineers or were destroyed by them. Any non-Klingon boarding parties allied to the Klingons (e.g., Lyrans and/or Romulans during the General War) remain on board and can attempt to recapture the ship.

#### **(G6.4) POSSIBILITY OF THE OFFICERS MAINTAINING PARTIAL CONTROL**

**(G6.40) BOOM CONTROL:** The "loyal" members of the crew (mostly officers in the command module at the end of the boom) may have managed to retain control of the bridge area. Determine this by die roll. A "1" or "2" means the boom has been captured by the mutineers. Otherwise, the loyal officers have maintained control of the boom. Certain options (see below) are then open to the officers (who remain under the direction of the Klingon player).

**(G6.401)** If the officers allow the mutiny to be automatically successful (G6.25), they automatically retain control of the boom.

**(G6.402)** In the case of a ship with a non-separable boom (e.g., E4), or ships without a specific boom (e.g., bases, freighters, etc.), option (G6.42) is not available but the others are.

**(G6.41) SELF-DESTRUCT:** The officers may attempt to activate the self-destruction device. This is successful only on a die roll of "1." Refer to rule (D5.53). Self-destruction may be attempted only one time per turn under these circumstances; the crew in the rear hull cannot deactivate the system. If successful, the boom automatically escapes by (D21.5). Note that the mutineers might succeed in deactivating the self-destruct given enough time (G6.434).

**(G6.42) SEPARATION:** The officers may separate the boom from the rest of the ship and attempt to return to friendly space (C7.3). In fleet actions this becomes important as the boom section may be able to escape independently (G12.0). You are allowed to attempt destruction of the rear hull immediately after separation.

**(G6.43) CONTINUATION:** If the boom does not separate, and if self-destruction is either not accomplished or was not attempted, then the situation on the ship is unresolved.

**(G6.431)** The movement of the ship is controlled from the rear hull. [As the mutineers cannot control the ship, this would mean that the ship would stop unless other qualified personnel were brought into that area; see (G6.51).] The two sections (hull and boom) cannot use each other's equipment or power. Loyal boarding parties from other Klingon (or allied) ships may be transported into the boom at the higher non-combat rate (G8.32).

**(G6.432)** The mutineers in the rear hull cannot enter the boom due to the security doors unless they win a boarding party action initiated by the crew in the boom or under (G6.434).

**(G6.433)** The boom and rear hull are treated for boarding party combat as two docked ships under (C13.961) although this docking is mechanical and does not require a tractor beam.

**(G6.434)** No situation can go on indefinitely. The crew in the rear hull would be able to disable the security doors (G6.432) in 100 turns. The crew in the rear hull would be able to disarm the self-destruct device (G6.41) in 50 turns.

**(G6.435)** If enemy boarding parties are on the mutinous ship, they may be able to avert the self-destruct system under (D7.71), but they will not be able to breach the security doors any faster than the mutinous crew.

**NOTE:** If using (D16.0) from Module M, see the various rules there regarding partial control of a ship.

#### **(G6.5) CAPTURING A MUTINOUS SHIP**

Once the mutineers have seized control of the ship, either player may attempt to regain control.

**(G6.51) CREW:** The non-Klingon player may use transporters (G8.0) or shuttles (J2.0) to place a skeleton command crew on board. This skeleton crew will be able to operate most of the systems on the ship; see (D7.54) and (D7.55). This skeleton crew must consist of at least the specified minimum number of crew units (G9.41) and must be drawn from the opposing player's ships.

**(G6.511)** Coded safety interlocks make it all but impossible for any non-Klingon to fire the weapons. Exception: See (G22.75).

**(G6.512)** The Klingons could also transport crew units aboard, but will only regain the loyalty of all surviving units when and if control is reestablished by boarding party combat.

**(G6.52) MARINES:** Both players may use transporters to attempt to place boarding parties (D7.0) on the ship to capture or defend it. Or see the advanced rules in (D16.0).

#### **(G6.6) OTHER EFFECTS OF MUTINY**

**(G6.61) MONSTERS:** If mutiny occurs in a monster scenario, the ship disengages by (C7.4). It is assumed that an officer is being coerced to operate the navi-computers. The scenario is over at that point.

**(G6.62) CASUALTIES:** After the mutiny is over, assume that 2/3 of the crew units on board at the time the mutiny began have survived; the remainder died in the fighting.

#### **(G6.7) NOTE ON KLINGON SHIPS**

All Klingon ships (except those noted) have security stations. In most cases where a standard ship is modified for Klingon use, this addition will be noted. In other case (freighters, free traders, auxiliaries, etc.), it can be assumed that two separate one-box security stations are added. There is no change in BPV; the chance of a mutiny is cost enough.

### **(G7.0) TRACTOR BEAMS**

Tractor beams are magnetic force beams that are used for various purposes such as: to retrieve small objects, to land shuttlecraft, to tow other starships, to prevent drones from striking their targets, etc. Tractors cannot dismember starships.

Note that the tractor rules are written in terms of "ships" (which include bases and PFs). Non-ship units do not have tractor boxes on their SSDs (most do not have SSDs).

#### **(G7.1) GENERAL RULE**

**(G7.11) SSD:** Each TRAC box represents one tractor beam.

**(G7.12) ACTIVATION:** Tractor beams may only be activated during the Operate Tractors Step of any impulse of a turn.

**(G7.121)** Once attached, tractor beams can be released under (G7.33).

**(G7.122)** Once attached, tractor beams can be broken by negative tractor (G7.35), disengagement (G7.28), fighter breakaway (G7.55), destruction of the tractor beam (G7.34), energy reductions due to damage (D22.0), web being cast between the tractoring ship and the tractor object (E12.6), displacement of either unit (G18.672), another unit counter-tractor the held unit (G7.37) or the tractoring unit (G7.91), break down (C6.545), trying to drag a unit through an atmosphere (G7.323), one or the other being placed in stasis (G16.0), or other means as provided by the rules.

**(G7.123)** Tractor beams may be used at any speed up to 32. (This refers to the speed of each unit involved, not to their relative speeds or closure/separation rates.)

**(G7.124)** A tractor beam may continue to be attached into a subsequent turn, but this requires the application of sufficient new power; see (G7.42).

**(G7.13) SEQUENCE:** Each tractor beam on a given ship may only be used once each turn. A given tractor beam cannot be used again (on different or the same objects) on the same turn (or within 8 impulses on two consecutive turns) of its link being released or broken.

**(G7.14) FIRING ARCS:** There are no firing arcs for tractor beams. (They all may be used in any direction.)

**(G7.15) ENERGY COST:** One unit of energy is required to operate each of a ship's tractor beams. Additional energy may be used to operate the tractor at a longer range (G7.6) or to overcome the effects of negative tractor (G7.35).

Fractional units of power cannot be used for tractors or negative tractor. Only whole units of power can be used for these functions.

**(G7.16) MULTIPLE BEAMS:** There are various conditions when multiple tractor beams are involved. See also (G7.37).

**(G7.161)** A ship can generate several tractor beams (one per tractor box on the SSD) and attach each to a different object; for example, a PF tender recovering its PFs (K2.35).

**(G7.162)** No more than one tractor beam can be used (or attempted) by one ship on another unit at any given time (during any given step of the Sequence of Play). Multiple tractor beams could tractor several objects (one per available beam) at the same point in the sequence of play.

**(G7.163)** Tractors on some bases can hold more than one unit; see (C13.141).

### **(G7.2) USES OF TRACTOR BEAMS**

There are many uses for tractor beams, some of which are explained below or in the other rules noted below.

Other uses that deserve mention include: gravity landing system (P2.432), raising and lowering objects from a planetary surface (P2.44), ground bases tractoring ships (P2.712).

Some units cannot be tractoried; see bases (G7.251), plasma torpedoes (G7.26), and ships in a web (G10.1163). See (C10.52).

**(G7.21) TOWING:** Tractor beams can be used to tow various objects, including ships. Towing restricts the movement of both the towing ship(s) and the towed unit(s). Towing enemy units can serve a variety of tactical purposes. See (R1.10B) for towing a Fleet Repair Dock.

**(G7.211)** Ships which have no forward (or reverse) speed use the procedures of (G7.32). To tow moving ships, additional procedures are found in (G7.36).

**(G7.212)** Being held in a tractor beam imposes various restrictions on the towed ship; see (G7.9).

**(G7.213)** A tractor beam applied to a friendly unit can have only one effective point of power, exception (G7.37). More power may be required by an auction (G7.37) with an enemy ship for control of a friendly unit.

**(G7.214)** Under the friendly fire rules (D1.5), a unit cannot tractor a friendly unit if doing so would cause the destruction of that unit except as allowed therein.

**(G7.22) SHUTTLES:** Tractor beams can be used to land shuttles; see (J1.62). Tractor beams can also be used to drag aboard (G7.8) or to destroy (G7.54) enemy shuttles. While shuttles can be dragged by ships, shuttles can never tow ships.

**(G7.23) DOCKING:** Tractors are used for various means and types of docking. See:

ships (friendly or enemy) docking to ships (C13.9). Note particularly the restrictions of (C13.96).

ships docking to or inside bases (C13.0).

mech links for PFs and shuttles (K2.2).

**(G7.24) TERRAIN:** Various types of terrain have various effects on tractor beams.

**(G7.241)** Planets (P2.0) cannot be tractor beamed, but large meteors (SH3.0) can be. There are exceptions (some of which require the ship to be at speed zero) in the cases of the gravity landing system (P2.432); raising objects from and lowering them to a planetary surface (P2.44); bases on planets (P2.712); or using rotation to pull your ship toward a planet, moon, or large asteroid (G7.252). A planet or asteroid held in a tractor for this purpose (and all of the units on it) is not under the restrictions or penalties of (G7.9).

**(G7.242)** Asteroid counters cannot be towed by tractor beam (they represent fields of hundreds of asteroids; you could not, within the time of a scenario, move enough of them to create a new asteroid hex or clear out an existing one).

**(G7.25) BASES:** Bases with active positional stabilizers (G29.0) can be tractoried by a moving ship; see below. (All bases in Basic Set have active positional stabilizers.) In Advanced Missions; (C13.11) allows ships to dock with a base using tractor beams while moving at a speed of 1 or 0.

**(G7.251)** If a moving ship attaches a tractor beam to a base with positional stabilizers, it is resolved under (G7.36); the base has a movement cost of infinity (giving the ship a pseudo speed of zero). The ship is still "moving" at the original speed and does not "stop" for purposes of WWs, acceleration, etc. See (C2.4) for speed definitions.

**(G7.252)** While a ship could not tow a base with a tractor beam, a non-moving ship could establish a tractor beam to a base and use the beam to pull itself to the base at a speed of one hex per turn by using the rotation system (G7.7). A ship could also use this system to pull itself to a planet or large asteroid (G7.241). Once you pull your ship to the planet, it will have to land by one of the procedures in (P2.4).

**(G7.253)** A base with positional stabilizers (G29.0) can tractor a moving (or non-moving) ship (within the limits of other rules). The situation is resolved under (G7.36); the base has an infinite movement cost, so the ship will have a pseudo speed of zero (while still retaining its higher practical speed and maneuver rate). See (C2.4) for definitions of speed.

**(G7.254)** Bases with active positional stabilizers are exempt from the conditions of (G7.9); see (G29.21).

**(G7.255)** A ship cannot tractor another unit that is docked to a base. A ship docked to a base cannot tractor anything except the base (C13.48).

**(G7.256)** Unless specifically designated in a particular unit description or scenario, all bases have active positional stabilizers (G29.0) and are covered in the preceding subsections of (G7.25). All bases in Basic Set have active positional stabilizers. Only in the extremely rare circumstance in which a base has been designated as being without active positional stabilizers, it is treated (for the purposes of the tractor rules) as a ship moving at a speed of zero using (G7.32). Its movement cost is given in Annex #7L (add the cost of the base and all of the modules and other units docked to it). Bases without active positional stabilizers are not subject to (G7.251) through (G7.255). A base which is operational on a planet, small moon, planetoid, or large asteroid is always treated as if it has active positional stabilizers.

**(G7.26) SEEKING WEAPONS:** Tractor beams cannot be used to hold plasma torpedoes. For the effects of tractor beams on drones and seeking shuttles, see (G7.52).

**(G7.27) FORCED CONTACT:** Objects held in a tractor beam cannot be forced into contact with another unit.

Exceptions: docking (C13.0) and landing shuttles (G7.8), and those noted below.

**(G7.271)** A tractor beam cannot be used to rotate, move, tow, or push mines. However, see minesweeping (M8.1). If a unit has a tractor applied to a mine, and the ship moves, the tractor link simply breaks and the mine is unaffected.

**(G7.272)** A tractor beam from a friendly ship cannot be used to tow or push a friendly seeking weapon; see (G7.522). Note that as even ballistically targeted weapons will go inert if tractoried by a friendly unit, (F4.5) does not form an exception to this rule.

**(G7.273)** On a fixed map, a tractor cannot be used to force a ship off of the map. In a tournament arena (P17.0), a tractor could be used to force a unit into the barrier, at which point the tractor link is broken. If a ship attempts to force or drag another ship off a fixed map, the non-tractorship is released from the tractor at the map edge unless special scenario rules say otherwise. An enemy ship cannot be towed off of a fixed map unless it has been captured. The towing ship must leave with the towed ship or the tractor link is deemed broken.

**(G7.274)** If a unit is connected to another unit by a tractor beam, and either unit attempts (voluntarily or not) to enter a planet or moon hex, the tractor beam is broken by gravitational effects before the unit enters the hex. (Large asteroids and meteors are ignored for this purpose.) If the unit attempting to enter the planet hex is a seeking weapon (including an unmanned or seeking shuttle), this rule is ignored. A seeking weapon can be forced into a planetary surface (resulting in its destruction without detonating the warhead).

**(G7.275)** A unit could be forced to enter an asteroid (P3.0) or ring (P2.223) hex while linked to another unit by a tractor beam and moving under the terms of (G7.32) or (G7.36). Use the sum of the two pseudo-speeds at the instant of contact.

(G7.276) See (G7.75) in the case of rotations. See (G23.573) in the case of contact with an ESG field.

(G7.277) A unit can be forced into a web (G10.71).

**(G7.28) DISENGAGEMENT:** When a ship disengages by acceleration (C7.1), all tractor beams generated by it or attached to it are automatically broken. Note that a ship's disengagement speed is based on the energy applied to its movement (i.e., practical speed). The fact that the ship may be slowed down by its tractor link (even to an effective speed of zero in the case of a base tractoring a ship) has no bearing on its ability to disengage.

See (C7.4) for fixed map disengagement.

**(G7.29) MONSTERS:** Living monsters (i.e., those that are creatures rather than robot ships) cannot be tractorred; exception (S6.1) Result #2. See Annex #12. Any exceptions will be noted.

### (G7.3) OPERATIONS

Gaining a tractor beam hold on another ship or object is referred to as gaining a tractor link to the ship or object. This may be attempted during the Operate Tractors Step of any impulse (G7.12), but if a tractor link is made, it must be re-established at the start of each turn [see (G7.42) below] or it is lost. It is not mandatory to attempt to re-establish a tractor link.

Once a tractor link is established, it can be broken by various means listed in (G7.122). It cannot be broken by the application of speed, except as per (G7.28). It could be voluntarily released (G7.33) by the ship operating it.

**(G7.31) RANGE:** Tractor beams may only be used against ships or other objects in adjacent hexes or in the same hex; exception, see (G7.6). Tractor beams always use the true range, not the effective range (D1.4).

**(G7.32) TOWING A NON-MOVING SHIP:** This section refers to towing in general, specifically non-moving ships and other objects (those which can be both linked to and moved by a tractor beam). For additional requirements involving towing moving ships, see (G7.36).

The towing ship is considered to be the moving ship, regardless of which ship is generating the tractor link.

If a tractor link is made, the linked objects will follow the towing ship (maintaining a parallel course, moving in the same direction at the same time) for as long as the tractor link is maintained. Towing via tractor beam places a considerable strain on the ship. This is reflected by these rules. Note that the facing of the non-moving unit is only changed under (G7.322) and not as a result of any movement by the towing unit.

See (G7.9) for additional information on a ship held in a tractor beam.

**(G7.321)** When towing a tractor-linked ship or ships, the movement cost per hex is equal to the cost of all ships involved. For example, a Fed DN (1+1/2) towing a scout (1/2) and a CA (1) would have to pay 3 movement points per hex. When being towed by a friendly ship, the towed ship does not operate its engines for movement [if it does, it is handled under (G7.36) below]; exception (G10.56). See Annex #7L for towing costs of various units which do not have assigned movement costs.

**(G7.322)** For the purposes of this rule, a non-moving ship may expend movement points allocated for tactical maneuvers (C5.0) or HETs (C6.0); however, see (G7.3222) for breakdown.

**(G7.3221)** Tacs and HETs by one ship do not affect the other ship or the pair, regardless of which is doing the towing.

**(G7.3222)** The HET breakdown number (C6.51) is decreased by one for every ship (not including PFs or non-ship units) towed (i.e., held in a tractor beam); e.g., a rating of 4-6 becomes 3-6. A ship being towed (i.e., being held, even if it is the only one actually moving) is not subject to this penalty unless it is also tractoring a ship. The movement or non-movement of the ships is irrelevant; it is the question of which ship is generating the tractor beam that decides which is under the penalty. This applies only while actually linked by tractor; not after the tractor is released or broken.

**(G7.3223)** If a breakdown occurs, the tractor link is broken and cannot be restored on the current turn. In addition to the damage resulting from the breakdown, the towing ship takes one point of internal damage, distributed directly by the DAC

(D4.21), for each point of its practical speed (C2.411). For the remainder of the turn, the towed ship does not move, while the towing ship automatically tumbles (C6.55). Shuttles, fighters, and PFs do not count for purposes of this rule and are not affected by it.

**(G7.3224)** If tumbling occurs, the tumbling ship moves at its own effective speed.

**(G7.323)** Atmospheres impose special restrictions on tractor links. A tractor link cannot be maintained if either the towing unit or the towed unit move through an atmosphere at an effective speed (C2.46) greater than one. If such an event is about to occur, the tractor link is immediately broken prior to the anticipated movement, at the beginning of the appropriate Movement Step (this is outside the normal Sequence of Play). An object may not be rotated through more than one hex of atmosphere in a turn, even by (J1.621); see (G7.7). If the first hex entered (by towing) during the turn is outside the atmosphere, there is no restriction. An object must be lifted from the surface (P2.44) before "towing" can begin.

**(G7.324)** See rule (C2.46) to determine the turn mode and acceleration limits. Acceleration limits are based on practical speed (C2.21), not pseudo-speed (C2.413).

**(G7.325)** There is no additional cost in movement points expended by the moving ship for towing shuttles, fighters, or drones or for docked PFs. There is an exception when towing a fleet repair dock; see (R1.10B3). Shuttles, fighters, and drones cannot tow ships.

**(G7.326)** The courses are parallel in relation to the map grid, not in relation to each other. If a ship that is holding an object in a tractor changes facing, the held object does not "swing" through a 60° arc to maintain the same orientation. Ships directly docked to each other use the procedure in (C13.922).

**(G7.33) RELEASING A TRACTOR BEAM:** If a tractor beam is attached to an object, it can be released voluntarily by the owning player during the Operate Tractors Step of any impulse.

**(G7.331)** A unit released from a tractor beam operates normally for the remainder of the turn, moving with a speed equal to that with which it would have had without the beam [i.e., at its "legal speed plot" (C1.341) which may include speed changes under (C12.0)]. The turn and sideslip mode records of a ship are continuous whether or not it is held in a tractor beam (G7.93). The actual turn mode requirement may change with conditions, but the accumulation of hexes is unaffected.

**(G7.332)** If a tractor link is voluntarily released, it cannot be re-established by the releasing ship between those two units within 1/4-turn. The released ship could tractor the releasing ship. Not maintaining a tractor link during an Energy Allocation Phase by not powering it counts as voluntary release, although the specific tractor would be available to tractor some other unit during the turn (or even the original unit) after eight impulses. Releasing a tractor under (D22.13) is also considered a voluntary release even though it may be out of the player's hands.

**(G7.333)** If a ship which is using a tractor beam launches a wild weasel, it must involuntarily release the tractor beams at the time the weasel is launched in the Shuttle Functions Stage. This would allow a ship released from the dropped tractor to launch its own WW on the same impulse. See (J3.452) for details, conditions, and exceptions.

**(G7.334)** A tractor beam may be dropped during the Energy Allocation Phase; see (G7.42).

**(G7.335)** Tractor beams may also be released as a result of the destruction of the tractor box on the SSD (G7.34).

**(G7.336)** Certain interactions with planetary bodies may cause the immediate involuntary release of a tractor beam. See (G7.274) and (G7.323).

**(G7.337)** Tractor links to a unit that breaks down are not broken unless that ship tumbles (C6.553), or a towed ship suffers a breakdown (G7.3223).

**(G7.34) DESTRUCTION OF TRACTOR BEAMS:** The destruction of tractor beam boxes on the SSD may result in existing tractor links being broken.

**(G7.341)** A player can assign existing tractor links to any of the tractor beam boxes on his SSD, but once assigned the specific link and the specific box on the SSD are "associated". Which link is associated to which box is known to the opponent at Tactical Intelligence Level E (always known if TacIntel is not in use). The opponent must request the data, but he must be informed of any subsequent changes in data previously requested if still at Level E or better.

**(G7.342)** Existing tractor links can be transferred between SSD boxes only during the Operate Tractors Step of the Sequence of Play. Transfer is made by adjusting records.

**(G7.343)** If a given tractor beam is destroyed, the associated tractor link is immediately released and the energy in it is lost. Since most damage (once designated by the DAC) is assigned to specific boxes by the owner of the target unit, that player can select which tractor box to give up based on his view of the priority of the associated tractor links. However, as hit-and-run raids (D7.8) can attack specific systems, this is not always the case.

**(G7.344)** Any tractor beam on the ship can perform any function (e.g., the nose tractors on a Klingon D7 can be used to land shuttles in the bay). Any exceptions are in the ship descriptions for the relevant units (e.g., the tractor beams on a starbase module can only dock units in or to that module).

**(G7.345)** Destruction of a tractor beam does not force units to drop "hard docked" units such as tug pods formally attached to a tug (G14.4) or PFs held in mech links (K2.3).

**(G7.35) NEGATIVE TRACTOR BEAM:** In the event that a tractor is established between two opposing ships, the tractored ship may, but is not required to, attempt to break the tractor. This can be done by applying power to "negative tractor beam" or other means listed in (G7.122). The primary method of breaking a tractor beam is to apply power to negative tractor.

**(G7.351)** During the Energy Allocation Phase, energy allocated to tractor beams is not designated as intended for "positive" or "negative" use. This designation is made only at the time each point of power is actually used, but once made it cannot be changed and remains in effect until the end of the turn unless dropped (G7.358) or released (G7.33). Note that tractor energy is lost when the tractor is released and cannot be used again, see also (G7.414).

A unit with energy allocated to tractors can designate this energy for use as negative tractor at any point, including the point at which an enemy unit tractors the unit. In such case, the negative tractor energy takes effect immediately and the enemy tractor beam, if fully cancelled, will never take effect.

Tractor energy allocated as part of an auction is designated as positive or negative at that point.

Reserve power allocated to tractors is designated as being negative or positive at the point at which it is used. Reserve power which is released as allocated power at the end of an impulse without being immediately used (H7.1) is treated as allocated but undesignated power from that point.

**(G7.352)** Each point of power applied to "negative tractor" (whether allocated or reserve) cancels one point of effective power of a tractor beam applied to the unit using negative tractor. Note the term "effective power." A ship three hexes away would be spending three points of power to generate one point of effective tractor beam (G7.6), and this point of effective tractor energy (produced by three energy points) would be cancelled by one energy point committed to negative tractor.

**(G7.353)** Power applied to negative tractor lasts for the entire turn (or for the remainder of the turn in the case of that from reserve power) and is used to counter any attempt to tractor the ship for that time, whether by the same or a different unit. Note that negative tractor will block friendly as well as enemy tractor links.

**(G7.354)** Negative tractor beam is not a special device, but is designed into the hull of the ship. Negative tractor beam does not require or use a tractor beam box on the SSD.

**(G7.355)** Shuttles (which of course includes fighters), drones, and non-unit bodies (e.g., asteroids, planets, etc.) can never use negative tractor. (Neither can plasma torpedoes, but as they cannot be tractored, this situation is meaningless.)

**(G7.356)** Fractional points of power cannot be used for negative tractor beam purposes. See (G7.15).

**(G7.357)** Negative tractor beam does not require active fire control (D6.6) and will not void a cloak (G13.432) or wild weasel (J3.452).

**(G7.358)** Negative tractor energy can be voluntarily cancelled (as releasing a tractor beam), but if this is done, the energy is lost. Part of the energy can be cancelled and the rest retained.

#### **(G7.359) TACTICAL EXAMPLE**

A Klingon D6 successfully wins a tractor auction with a Kzinti BC. The BC had tried to anchor (G7.98) the D6 with a tractor beam so it could be destroyed with a massive drone attack; with a tractor in place, the D6 could not launch a WW and would have been destroyed.

The D6 has 23 points of negative tractor (a very high amount, but what it took to win the auction), but is moving at speed 4 due to the lack of power to move faster and to preserve the WW option.

A Klingon C8 is nearby and wants to tow the D6 out of range, but cannot attach a tractor beam due to the massive amount of negative tractor. The D6 drops 20 points of its negative tractor (the C8 overcomes the remaining 3) and accepts the tow, but the C8 releases the D6 some 11 impulses later (now that the D6 is out of danger).

Later during that same turn, a Kzinti CV moves into a position one hex from the D6 and tries to tractor the D6. The CV has 6 points of energy allocated to tractors, and while it could have tractored the D6 at range 2, this would have produced only 3 effective points of tractor energy and would have been negated by the remaining negative tractor. The D6 cannot use any of the 20 points of negative tractor energy that it voluntarily cancelled.

With very little energy left (the 3 remaining negative points and 2 points of battery power were all that was available), the D6 is helpless to resist a subsequent anchor (G7.98) and is destroyed by 12 type-IV drones. To add insult to injury, the crew cannot escape (D21.41) in the shuttlecraft as both had been prepared as wild weasels for defense against drones. The boom separates (G12.01) and escapes (D21.43), so the officers survived.

Had the officers been paying attention, they could have launched a WW when the CV approached, protecting themselves from being tractored (at least until the CV destroyed the WW and the explosion faded, by which time perhaps the C8 would have come back).

**(G7.36) TRACTORING A MOVING SHIP:** These procedures are used to resolve movement when two moving ships are linked by an active tractor beam. These rules are additional procedures to those in (G7.32). They apply when both ships in a tractored pair are generating movement points. All restrictions and conditions of (G7.32) apply to ships moving under (G7.36) except where noted.

See also (G7.9) and (G7.3223) for additional restrictions.

The procedure is used whenever the two ships are linked and for as long as they remain linked. If this movement results in any condition that would break the tractor link, the link is broken.

**A-**Determine the total movement cost of both ships.

**B-**Determine the speed that each ship would move assuming its current energy allocated to movement and the total movement cost of both ships (drop all fractional points of movement). However, the impulse power of the smaller ship is ignored. (If the two ships are the same size, ignore all impulse power unless the two ships agree for one of them to use its impulse power. If only one ship applies impulse power, that power is used by that ship.) This is known as its pseudo-speed (C2.46). The pseudo speed cannot be more than 15 (16 if impulse is available) if two movement cost one ships were involved because no ship can generate more than 30 points of movement from warp energy. If the movement costs were different, one would have a higher pseudo-speed than the other. In the case of ships with plotted (or making unplotted) speed changes, assume that the current speed is continued for the entire turn. When a unit announces that a mid-turn speed change is going to take effect, the pseudo speed is then recalculated based on the new speed and again assumes that that speed was used for the entire turn from that point.

**C-**Each ship moves both ships whenever its movement is called for by the impulse chart for its pseudo-speed and can turn when its turn mode is satisfied at that pseudo-speed. If both ships are scheduled to move in the same impulse, this is resolved as follows:

1-If the result of both ships' movement is that both ships return to the hexes where they began the impulse, neither moves.

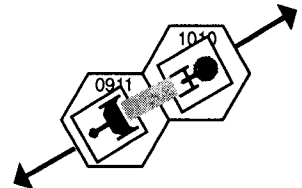



2-If the result is that each ship moves one hex, they move directly to that hex. For example, a ship (in a tractor link) is in hex 1010. It wants to move in direction B, but the other ship wants to move in direction F. The result is to move one hex in direction A. The ship does not move to hex 1110 (or 0910) on its way to 1009, but moves directly there.

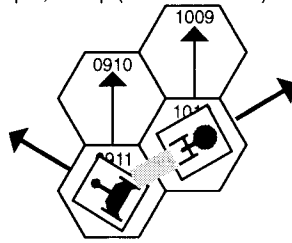

3-If the result is that each ship moves two hexes, the larger ship (by size class; then by movement cost if the same size class) conducts its movement first, then the other ship moves on the next impulse. [If they are the same size, use the Order of Precedence in (C1.313), using the pseudo-speed of each ship. If that does not resolve the matter, both ship captains write down their intended direction of movement, then toss a coin or roll a die to determine which ship reveals and conducts its movement first.] For example, a ship in hex 1010 wants to move in direction B, but a larger ship linked to it wants to move in direction A. The ship is then moved one hex in direction A (to 1009), then on in direction B (to 1109) on the next impulse. The movement of the second ship must be executed as originally stated on the subsequent impulse, and cannot be changed even if there are VERY strong tactical reasons that indicate that he should change it.

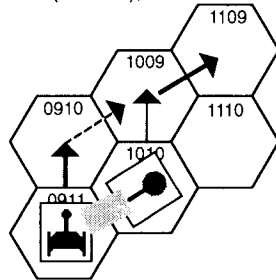

If this occurs on Impulse #32, the second ship's movement takes place on Impulse #1 of the subsequent turn (unless the link is not maintained). Ships cannot move more than one hex in one impulse. In this case, the larger ship moves both ships on the current impulse, and the second hex of movement (caused by the smaller Fed DD) is conducted on the next impulse. (If both are the same size, toss a coin.) If further movement is scheduled for that next impulse, that movement is delayed one impulse so that the movement delayed from the previous impulse can be conducted sequentially. (This can continue indefinitely although the mathematics will make it even up once per turn. All movement points are conducted in the order they are earned, even if an impulse late.) If the tractor link is released before an owed movement point is conducted, it is simply lost. If two ships are tractor on Impulse #32, both perform any HET maneuvers during Impulse #32 even if the ship in question is the one that will not conduct its movement until Impulse #1 of the next turn.

**EXAMPLE OF MOVEMENT BY TRACTORED SHIP**

A Klingon F5 (movement cost 1/2) tractors a Federation DN (movement cost 1+1/2). The F5 has allocated 5.5 units of warp energy and 1 unit of impulse energy to movement, which would call for a speed of 12. The DN has allocated 20 units of warp energy and 1 unit of impulse energy, which would call for a speed of 14. The total movement cost of the two ships is two energy units per hex. The F5 thus has a pseudo-speed of two hexes per turn (5.5 divided by 2 dropping all fractions and ignoring its impulse power). The DN has a pseudo-speed of 11 (20 divided by 2 plus the 1 point for the impulse engines). The tractor link was established on Impulse #14. On Impulse #15, a ship with a speed of 11 would move, so the Federation player would move both ships one hex in the direction that the DN was facing (or was turned to face within the restrictions of its turn mode). During this movement, the F5 will retain its facing. On Impulse #16, a ship with a speed of 2 moves, so the Klingon player moves both ships. In this case, the F5 captain must apparently be trying to slow down the DN so that other Klingon ships can engage it. If not, the DN captain will probably tow him behind some convenient

asteroid and beat the daylights out of him! (But the DN captain must be careful, or the F5 captain will steer him into the asteroid field!)

**(G7.37) MULTI-TRACTOR ENGAGEMENTS:** Various conditions arise when two or more ships are linked by tractor. Note that these complications are not generally created by non-ship units.

**(G7.371)** In the event that two or more ships tractor a single object (e.g., ship, shuttle, asteroid, etc.), an auction (G7.42) is conducted and the tractor beam with the most effective power (as adjusted for range) establishes a link on the object; the other ships immediately release their tractors. This auction is conducted before (and independently of) conducting any auction against negative tractor energy generated by the tractor object. All positive tractor power used by the winner remains and applies to the further resolution. Tractor power bid by other units is lost. Note that once this auction is over, another would be held immediately between the winning-tractoring unit and the tractor object (which could try to break the tractor with negative tractor).

**(G7.372)** Under some circumstances, a unit held in a tractor cannot tractor other units (G7.91). Because of this, one way to force a ship to release a tractor is to tractor the tractoring ship.

**(G7.373)** In the event that three or more ships are linked by tractors, only two of them can produce pseudo-speed. Ignore any unit not generating practical speed. The pseudo speed of the combination is calculated based on the combined movement costs of all the units in the tractor link. If three or more units are generating movement points, ignore the points generated by the smaller units and use the pseudo-speeds of the two largest units. (Largest is defined first by size class and then by movement cost.) If there are three or more "largest" units, use one from each "side" of the battle (assuming there are two sides), with the owners selecting the ships to be used. If the largest ships are all on the same side, the owner selects which to use. If the largest ships are from three or more sides, each of the ships "tied" for this purpose rolls one die, with the ships having the two highest die rolls being used. This decision procedure is repeated whenever a ship joins or leaves the linked group and at the start of each turn. Each ship calculates its pseudo-speed for its own turns and facing changes based on its own generated movement power and the total movement cost, even though only two ships can affect the movement of several ships linked by tractors.

**(G7.374)** Tractors used to hold two units in a docked configuration (C13.0) are exempt from all of these provisions. The two docked units are considered a single unit for this purpose. It is not possible to use a tractor beam to forcibly undock another unit (e.g., a ship from a base, a PF from a mech link, a module from a base, a pod from a tug, etc.). See (C13.921) in the case of two ships docked to each other.

**(G7.375) EXAMPLE:** A Federation CA (size class 3) establishes a tractor link on a Klingon F5 (size class 4). Later a Klingon D7 (size class 3) tractors the CA in an attempt to slow it down; the CA has no power to negate the D7's tractor, so the D7 successfully establishes a link. At this point the CA is not forced to release its hold on the F5 because the D7 is not larger than the CA and because the D7 is an enemy ship (G7.91). The CA chooses (perhaps to keep the F5 from doing more mischief) to maintain its link on the F5. The movement points generated by the F5 (the smallest ship among the three linked units) do not count for purposes of (G7.36).

Later a Klingon C8 (size class 2), capable of generating the same effective positive tractor power as the D7, declares it will establish a tractor link on the Federation CA. Under (G7.371), the C8 is required to conduct an auction with the D7 to decide which ship maintains a tractor link; if an auction was held and neither ship won, both tractor links would be lost. Since the two ships are on the same side, they simply agree that the C8 will establish its link and the D7 voluntarily drops its link.

Furthermore, since the C8 has a larger size class than the CA, per (G7.91) the CA is now required to immediately release its tractor on the F5. The Federation CA can now only tractor and fire at the Klingon C8 (although the CA can also fire at other non-ship units).

**(G7.4) TRACTORING A STARSHIP**

**(G7.41) CONDITIONS:** The conditions for tractoring a starship (enemy or friendly) are as follows:

A. The tractoring ship must be in an adjacent hex or the same hex as its target [see (G7.6) for extended range] and have an operable tractor beam. It must have a lock-on to the unit to be tractoried (unless they are already docked).

B. The tractoring ship must allocate power to that tractor beam. Reserve power can be used to initiate or reinforce a tractor link.

C. The starship being tractoried may have allocated power to tractors and could use this for "negative tractor beam" (G7.35). (If it did not have power allocated for negative tractor on the first turn of being tractoried, it will have the opportunity to allocate power to this purpose on the next turn when the tractor must be re-established.) The tractoring starship must have allocated an amount of power equal to the amount allocated to negative tractor beam, plus one effective point [this may take more actual power at longer range (G7.6)] in order to maintain the tractor. Note that the effective strength of the tractor beam (as adjusted for range) must EXCEED, not merely equal, the strength of the negative tractor force applied.

**NOTE:** A ship or object that has been tractoried is NOT considered to be captured for victory purposes until it is actually boarded and captured by (D7.0) or (D16.0). This may extend the scenario beyond the normal end point.

**(G7.411)** Reserve power (H7.2) can be used for negative tractor beam and to reinforce a tractor beam.

**(G7.412)** A tractor link cannot be established without a lock-on. However, should a tractor link exist between two ships, both automatically have a lock-on to each other. This assumes that each ship has active fire control, even if it did not obtain a lock-on previously, and that the period for activation of fire control (D6.333) has expired. If not, a ship without AFC has no lock-on. See also (D6.11).

**(G7.413)** Movement is governed by (G7.32) and possibly also by (G7.36).

**(G7.414)** If a tractor link is established during a turn, an immediate auction (G7.42) is conducted using reserve and allocated power. The player establishing the link is not required to reveal how much power he has allocated until it is used in bidding. Note, however, that negative tractor energy can be reused on the same turn against later links, but active tractor energy is lost once the link is broken or released. If the link survives the auction, the tractoried ship can reopen the bidding on any subsequent impulse if power is available. A new auction is also required at the start of each turn, during Energy Allocation.

**(G7.415)** Electronic warfare can prevent a tractor link from being established; see (D6.37).

**(G7.42) TRACTOR AUCTIONS:** If a tractor beam was established during a prior turn, then the two ships involved must determine if it is broken at the start of each turn. This is done by an auction during the Energy Allocation Phase. Auctions may also be held during a turn. Note that the player who is maintaining the tractor must announce his intention to either maintain or drop the tractor link. If he announces that he will not maintain it, there is no auction.

**(G7.421)** The tractoried ship announces how many points of energy it is applying to "negative tractor beam." The capturing ship then announces whether or not it will match this amount. If not, the tractor is broken; if yes, the tractoried ship may then increase the amount of power applied to negative tractor beam. The auction continues in this manner until either the tractor is broken (G7.122) or the tractoried ship is unable or unwilling to apply more power. Remember that negative tractor can only be in whole units of energy and that positive tractor must be in whole units of effective energy (which may require multiple units of actual energy at longer range).

**(G7.422)** Whatever the result, both ships are required to expend the energy they committed themselves to expend in the auction. This is defined/explained below:

**(G7.4221)** If the tractoring ship loses the auction, the power it committed is lost irrevocably, and even if the tractor is re-attached later with reserve power, this energy cannot be reused.

**(G7.4222)** The power applied to negative tractor by the tractoried ship remains in effect until the end of the turn regardless of the outcome of the auction. If the tractoried ship lost the auction, it can reopen the bidding later (with available reserve or allocated power), in which case the power it committed to negate the

tractor remains available for use unless cancelled (G7.358). Whether winning or not, the negative tractor energy cannot be used for any other purpose.

**(G7.423)** Auctions can also be held (entirely with positive tractor energy) between two ships trying to tractor a third object (G7.37).

**(G7.424)** In the event that several ships are involved, or that two ships may have tractoried each other, or that two ships may be tractoring a third object (or any/all of the above), each ship secretly records its negative tractor energy, then simultaneously announces it. All ships trying to maintain tractors then secretly record which tractor links they are generating will be reinforced with additional energy to match this negative tractor energy (or positive tractor energy to the object by a third ship). The process is then repeated until all situations are resolved (G7.421).

**(G7.5) TRACTORING SHUTTLES AND DRONES**

**(G7.51) CONDITIONS:** The conditions for capturing an enemy shuttle or drone are as follows:

A. The capturing ship must be in the same or adjacent hex [see (G7.6) for longer range] and have an operable tractor beam. It must have a lock-on to the unit to be tractoried.

B. The capturing ship must allocate power to that tractor beam appropriate to the range (G7.6). This requires one point of effective tractor energy (two points of energy at range two, three points of energy at range three).

The drone or shuttle could subsequently be rotated (G7.7); a shuttle could be pulled into the shuttle bay (G7.8). Shuttles and drones change facing whenever they would normally "move"; they do not have a pseudo-speed.

**(G7.52) SEEKING WEAPONS:** Plasma torpedoes cannot be held by a tractor beam (G7.26). Drones (and seeking shuttles) held in tractor beams are treated as follows.

**(G7.521)** If a drone is tractoried and held until its fuel is exhausted, it is removed from play (FD1.71).

**(G7.522)** If a drone is held in a tractor beam by a ship on the same side as the ship that fired/launched it, it loses its tracking and is removed from the board. (Captured ships are on the side that captured them.) Enemy seeking weapons do not lose tracking. Note that the application of any tractor energy at all will cause the seeking weapon to go inert, the fact that you were trying to wrest it from an enemy tractor and never actually held it has no effect.

**(G7.523)** Shuttles used as seeking weapons are treated as drones but are not removed from the board until destroyed. A suicide shuttle tractoried by a friendly ship loses tracking and is treated as per (J2.227). A scatter-pack tractoried by a friendly ship loses tracking and is treated as per (FD7.46). In any case, the shuttle might be destroyed if towed at high speed; see (G7.54).

**(G7.524)** These conditions apply whether or not the ship which tractoried the drone is the target of the drone.

**(G7.525)** If a seeking weapon is moved into the hex of its target (or vice versa) by rotation or towing (and the weapon has not become inert or destroyed), impact occurs at that point; see (F2.312).

**(G7.53) DRONE DESTRUCTION:** Drones cannot be destroyed merely by towing them with a tractor beam. They could be destroyed by forcing them into contact with a terrain feature (G7.274) or an ESG field (G23.573) among other things.

**(G7.54) SHUTTLE DESTRUCTION:** If a shuttle is held in a tractor beam by a ship moving faster (effective speed) than twice the maximum rated speed of the shuttle (ignoring booster packs), the shuttle is destroyed. This is known as "death dragging" by shuttle pilots.

See (G7.9433) for seeking shuttles.

See (J1.212) for speed definitions.

Note that as ships move before shuttles and seeking weapons in the Order of Precedence (C1.313), a suicide shuttle carried along in a tractor tunnel (G7.9433) might be death-dragged before it reached its target. Regardless of the speed of a given drone, it cannot be death-dragged as a shuttle can.

**(G7.541)** The shuttle is not destroyed simply by being held. When the ship moves (and by doing so attempts to drag the shuttle along), the shuttle is destroyed in the hex where it was before the movement.

**(G7.542)** A crippled shuttle is destroyed if towed at faster than twice its reduced speed (i.e., faster than its undamaged maximum speed).

**(G7.543)** An uncrippled fighter must have an opportunity to make an HET breakaway maneuver (G7.55) before it can be destroyed. If the ship is scheduled to move, the fighter can make the breakaway out of the normal Order of Precedence (C1.313).

**(G7.55) FIGHTER BREAKING TRACTOR:** An uncrippled fighter can break a tractor beam and avoid "death dragging" by performing an HET (J4.12) to face directly away from the tractor unit (even if already facing in that direction) and moving in that direction at its maximum possible speed (it does not have to use warp packs). The tractor is then broken, but the fighter cannot turn until it has traveled at least three hexes in that direction (it can sideslip). If the fighter is not able to accelerate to its maximum speed due to acceleration limits (C12.34), it will not be able to break the tractor with this maneuver.

See (C12.342) for speed change restrictions.  
See (G7.543) for additional data. See also (C10.134).

**(G7.6) EXTENDED RANGE (Advanced)**

Tractor beams may be operated at up to three hexes range. However, this requires additional power.

**(G7.61) RANGE 2:** Twice as much power must be allocated to each tractor for the specific function being used if the range is two hexes. To tractor a ship at a range of two hexes, calculate the power required in (G7.41) and double it.

**(G7.62) RANGE 3:** Three times as much power must be allocated to each tractor for the specific function being used if the range is three hexes. To tractor a ship at three hexes, calculate the power required in (G7.41) and triple it.

**(G7.63) EFFICIENCY:** Because of the inefficiency, one point of negative tractor power will cancel three points of tractor energy from a ship three hexes away. Similarly, a ship would have to use two points of power to overcome one point of negative tractor energy by a unit two hexes away.

At a range of 3, the ship trying to establish or maintain would have to use six points of power (two effective points of tractor) to overcome one point of negative tractor energy (three to overcome the negative tractor energy, three to hold the object).

**EXAMPLE:** A ship in hex 1212 wants to tractor a ship in hex 1215. As this is three hexes away, the tractoring ship must allocate three units of power. Should the tractoring ship later use negative tractor power, the tractoring ship must use three times as much power to maintain the tractor, plus that required to hold it.

**(G7.7) ROTATION (Advanced)**

A ship holding another object in a tractor beam has some control over its movement. If a tractor is maintained from the previous turn, the ship maintaining the tractor can conduct a rotation during the Initial Activity Phase. Note that rotation changes the position of a unit, not its facing.

See (J1.621) for a special rotation system used to land friendly shuttles and (K2.31) for landing PFs. See (P2.44) for use of the rotation system in lowering objects to or raising them from planets.

Tractor rotation (G7.7) is not the same as base rotation (C3.7).

Tractor rotations can move the object closer or farther away as well as to either side.

**(G7.71) PROCEDURE:** A unit or object held in a tractor beam can be "rotated" one hex per turn, at the start of the turn, after the tractor is re-established. The relative position of the tractor object to the tractoring ship is changed by moving it one hex (it must remain within three hexes of the tractoring ship) at the tractoring player's option.

**(G7.711)** If moved further away, extra power would be required (from reserve power or unused power allocated to tractors) or the strength of the tractor beam (G7.6) would be reduced (it could even be broken after the rotation is completed). A ship holding an object at a range of 3 hexes cannot push it to a range of 4.

**(G7.712)** If moved closer (e.g., from 3 hexes to 2), the strength of the tractor beam would be increased because the same power (G7.6) was covering less distance. (Tractor beams at range zero and range one are the same strength.)

**(G7.713)** In the case of two ships, the owner of the tractor beam being used controls the rotation, but the smaller of the two ships is the one that is moved by the rotation. If both ships have established tractor beams, the larger ship controls the movement created by rotation. Exception: (G10.562). Also note that an asteroid will always be considered a "larger ship."

**(G7.714)** If there is a choice of two hexes into which a unit can be rotated, the unit performing the rotation selects the hex.

**(G7.715)** If two ships are of equal size, there is no rotation although a ship maintaining a tractor link can pull the other ship one hex closer (or into the same hex if already adjacent) or push it one hex further away. The relative orientation of the two ships relative to the map directions will remain fixed, i.e., if one ship is in direction B from the other, any rotation will maintain that general facing at all times (tactical maneuvers, turns, or HETs, might change the relative shield facings). Example: On Impulse #32, Ship A moves from 2214 into 2215; ship B moves from 2216 into 2215. Ship A tractor's ship B. In the rotation step of the initial activity phase of the next turn, ship B can only be pushed into 2216. Note that if ship B was smaller than ship A, ship A could rotate ship B to a different (adjacent) shield facing (or if ship A was smaller than ship B, it could rotate itself to a different shield facing) even if they were in the same hex. If both are maintaining tractor links (to each other) and both wish to conduct a rotation, each writes down his intended rotation and the written records are exposed simultaneously.

If both wish to rotate closer, they move one hex (not two) closer. Both units roll a die; the ship with the lower die roll moves.

If both wish to rotate further away, they move one hex (not two) further apart. Both units roll a die; the ship with the lower roll moves.

If one wishes to rotate closer and the other further, no rotation takes place (the two rotations cancel).

If only one ship wants to do rotation, it does so within the rules. If there are two (or three) possible hexes into which the other ship could be pushed/pulled, the player conducting the rotation may select either one. For example, a ship in 3610 could push a ship in 3612 into either 3613, 3513, or 3713. A ship in 3610 could push a ship in 3711 into either 3712, 3811, or 3810. Over multiple turns, ships of equal size could (by pushing and pulling) change the shields that each is facing.

**(G7.716)** In the event that a ship has tractor links with two or more ships, it cannot be rotated.

**(G7.717)** In the event that a ship with tractor links to small units (size 5-7) is rotated, the drones and shuttles maintain the same relative position to the rotated ship. Exception: mines cannot be rotated; a ship with a tractor link to a mine which is rotated would lose that link. In the case of mines, see (M2.21).

**(G7.718)** Bases with positional stabilizers (G29.0) cannot be rotated; ships treat them as a "larger size class" (G7.713).

**(G7.719)** If two ships are in a situation where both can rotate one of them (e.g., an F5 tractoring and tractor'd by a Federation DN; either or both can rotate the F5), the larger unit uses its rotation while the smaller unit does not. If the units are the same size, see (G7.715).

**(G7.72) WHICH UNITS:** A tractoring ship may rotate (move) a shuttle, drone, other unit, or ship. Rotation refers to the hex it is in, not its facing.

**(G7.73) FACING:** The facing of a unit being rotated is controlled by the player who owns the unit or other object being rotated. Rotation does not change facing (heading), which remains unchanged (relative to the map grid). The owning player changes facing by the normal rules (G7.32)+(G7.36), including HET and Tac.

**(G7.74) PULLING:** An object could be pulled into the same hex as the tractoring ship by this method, or if tractor'd at extended range, it can be pulled closer to the ship. For example, a Federation DN in hex 0911 is holding a Klingon D7 in 0811 by tractor beam. The DN could rotate the D7 to hex 0810 or 0912 or pull it into 0911.

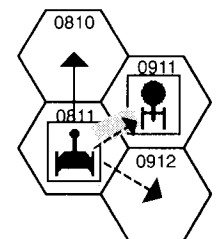

A unit could be pulled to range zero, but its relative facing remains the same and it cannot then be pushed away to the opposite side of the tractoring unit, e.g., an F5 could be pulled to range 0 of a Fed DN's #4 shield, but could not then be pushed to range 0 of the DN's #1 shield. It could be rotated to the DN's #5 or #3 shield.

**(G7.75) TERRAIN:** Due to gravitational interference, rotation cannot be used to move a unit or object into a hex containing a planet, moon, star, black hole, or pulsar. Exceptions:

Lowering an object onto or raising it from a planetary surface, see (P2.44).

An object can be rotated into the boundary of a tournament arena; see (P17.0).

An object can be forced into a web (G10.71).

**(G7.76) SEEKING WEAPON IMPACT:** If a unit is rotated into a hex containing seeking weapons targeted on that unit, the weapons will impact during the Movement Segment of the next impulse. The target will not be able to fire at the weapons before they impact.

If as a result of (G7.36-3) the unit rotated into a seeking weapon moves on Impulse #1, it exits the hex in the Order of Precedence (C1.313) before the seeking weapons impact. The seeking weapons may still strike the unit on Impulse #1 if it is in their FA arc, they also move on Impulse #1 (Speed 32 drones or plasma torpedoes), and their turn or sideslip mode is satisfied (if the target is not centerlined).

### **(G7.8) PULLING AN ENEMY SHUTTLE INTO YOUR SHUTTLE BAY (Advanced Rule)**

An enemy shuttlecraft or fighter held in a tractor beam and already in the same hex as the tractoring ship can be pulled into one of the tractoring ship's shuttle boxes (if an unoccupied one exists). This counts as the one "rotation" of that unit (G7.71) allowed per turn. The same rotation can pull a shuttle into the hex with the ship and into the bay.

The procedure in (J1.621) cannot be used with enemy shuttles. The enemy shuttle is landed aboard as per the rules and restrictions of (J1.620).

Once the enemy shuttle is inside the shuttle bay, the following procedures and rules apply. This procedure is also used in the case of an enemy shuttle that crashes into a shuttle bay; see (J1.63).

See (D7.63) for boarding party combat inside a shuttle bay.

**(G7.81) FIRING INSIDE THE BAY:** If an enemy shuttle that is pulled into a bay has weapons available to launch or fire, it can fire them inside the shuttle bay. (An enemy shuttle that crashed aboard of its own volition had to disarm its weapons due to the shock of the crash landing and cannot fire or launch weapons within 32 impulses of landing.)

**(G7.811)** Firing/launching inside the bay is conducted within the normal Sequence of Play (direct-fire and seeking weapons at different times; a fighter with both might destroy itself with one before the other can fire/launch). Each shuttle box damage point must be randomly distributed and might destroy the firing shuttle itself if they are scored on the box it is in. The procedure in (J1.413) can be used. See exception in (G7.813). A fighter/shuttle could fire every turn until destroyed or captured (although firing many weapons will destroy the shuttle).

**(G7.812)** The range is assumed to be zero, with half of the damage points (round up) scored on shuttle boxes (G7.811) in that bay and the remainder as internal damage (inside the armor). (If there are not enough undestroyed shuttle boxes available, all remaining damage points are resolved as internal damage.) See also (G7.813) and (G7.814).

**(G7.8121)** Roll normally for each weapon's fire; do not assume maximum damage due to the "can't miss" situation.

**(G7.8122)** If the weapon cannot fire at range zero, use the range one column.

**(G7.8123)** If two or more shuttles in the bay fire simultaneously, combine this into one volley but do not combine it with damage from other sources.

**(G7.813)** Weapons of the following types (photons, disruptors, plasma torpedoes, hellbores, plasma-D torpedoes, fusion beams, drones except type-VI) automatically and immediately hit, but the result destroys the shuttle (and the box it is in) as one point of the damage scored on the shuttle bay. The damage ignores shields and armor and is applied as in (G7.812). Hellbores score the full explosion strength. Proximity photons score the full unreduced (8 points) damage because the proximity fuse does not reduce warhead strength, but increases the detonation radius, and inside the bay the radius becomes irrelevant. Because this type of firing is literal suicide,

a fighter cannot do it unless it has been attacked by boarding parties (and survived the attack).

**(G7.814)** Weapons not listed in (G7.813) do not necessarily destroy the shuttle, but might do so if allocated (randomly) to the shuttle box holding the firing shuttle (G7.811). Type-VI drones score two points of damage. Phasers (and other weapons not listed) score their normal damage. ADDs score one point of damage (the only way an ADD can damage a ship).

**(G7.82) CAPTURE ATTEMPTS:** At the end of each turn that any uncaptured enemy shuttle is in the shuttle bay, boarding parties belonging to the ship can attempt to capture it. See (D7.631).

**(G7.83) CRIPPLED SHUTTLES:** If the shuttle has been crippled, it cannot fire any weapons or resist any attempt to capture it with boarding parties. See (J1.335) and (D7.632).

**(G7.84) BOARDERS:** If there are boarding parties on board the shuttle (friendly to the shuttle, not the ship), they may "board" the ship, in which case see (D7.633)–(D7.636).

**(G7.85) EXPULSION:** A shuttle could be expelled from the bay in the Operate Tractors Step of any subsequent impulse. This requires one tractor beam (within the normal rules, e.g., powered, undestroyed), which could continue holding the shuttle under the normal tractor rules. A shuttle could escape on its own if it is not held in the bay by a tractor beam. Fighters can not make an HET escape (G7.55) from the tractor holding them in (or expelling them from) the shuttle bay. Expulsion counts as "launching" the shuttle, including for purposes of (J1.50) and (J1.34).

**(G7.86) LOW-POWER ATTACKS:** Boarding parties on the ship could attempt to attack (rather than capture) the shuttle by firing at it with low-powered weapons. In such case see (D7.637).

### **(G7.9) RESTRICTIONS ON A UNIT WHICH IS HELD IN OR TOWED BY A TRACTOR BEAM**

A unit being tractoried (by a friendly or enemy tractor beam) is under certain restrictions defined herein. See (C11.32) in regard to nimble ships.

The holding unit is not affected by this rules section (G7.9).

**(G7.90) TRACTORED BASES:** Bases with active positional stabilizers (G29.0) are exempt from the restrictions of (G7.91), (G7.94), and (G7.98). All bases in Basic Set qualify. Ships docked to a base cannot fire at the base; see (C13.72).

**(G7.91) PRIMARY FIRING RESTRICTION:** A unit being tractoried (i.e., held in a tractor beam) cannot fire its direct-fire weapons or plasma torpedoes, or use its tractor beams, against any ship except the holding unit. Note that this restriction applies to "ships" and not "units," so the tractoried unit can fire at shuttles and seeking weapons (but not PFs). See also (G7.943) in regard to the launch of seeking weapons. Tractors do not affect special sensors (G24.0).

**EXEMPTION:** This firing (and tractoring) restriction (G7.91) is ignored if the tractoring unit is equal in size class to or smaller than the tractoried unit *and* if the two units are not on the same side. For example:

A Klingon F5 tractor a Federation DN. The F5 is not under (G7.91) because it isn't held in a tractor; neither is the DN because it is large enough to ignore the F5.

A Federation DN tractor a Klingon F5. The DN is not under (G7.91) because it isn't held in a tractor; the F5 is because the DN is too large to ignore.

A Federation DN tractor a Federation DD. The DN is not under (G7.91) because it isn't held in a tractor; the DD is because the DN is too large to ignore.

A Federation DD tractor a Federation DN. The DD is not under (G7.91) because it isn't held in a tractor; the DN is because its fire control is confused by the "friendly" tractor.

A Federation DD tractor a Klingon F5. The DD is not under (G7.91) because it isn't held in a tractor; the F5 is not because the DD is of an equal size class and the two ships are not on the same side.

A Federation DD tractor another Federation DD. The first DD is not under (G7.91) because it isn't held in a tractor; the second is because while the two ships are of equal size they are on the same side and the friendly tractor confuses the second DD's fire control.

In the event that two ships tractor each other, consider each case separately within the examples above.

**(G7.92) ERRATIC MANEUVERS:** A unit being held in a tractor beam cannot use erratic maneuvers (C10.24). See (C6.553) for an overriding condition.

**(G7.921)** A friendly unit using EM cannot be tractorized unless it drops EM and cannot adopt EM while held in a tractor.

**(G7.922)** If an enemy unit performing EM is grabbed by a tractor beam, all effects of EM stop immediately. If the enemy unit is later released or breaks free, the effects of EM resume. The external tractor is an overriding condition in addition to the unit's normal EM condition. If the enemy unit drops EM or adopts it, this takes effect but the effect will not be realized until the unit is released.

**(G7.93) FACING:** A unit being held in a tractor beam can use tactical maneuvers (C5.0), HETs (G7.36), or its normal turn mode (C2.413) to control its own facing. The holding unit cannot control the facing of the held unit. Docked units (C13.922) are treated as docked units, not tractorized units. See also (G7.3222) and (C6.0).

#### **(G7.94) RESTRICTIONS ON "LAUNCHED" UNITS**

**(G7.941)** A unit being held cannot launch fighters, shuttles, or PFs. A unit being held cannot drop a pod, pallet, or warp pack. These units do not have the power to escape from the tractor beam. While a fighter in space can break a tractor beam (G7.55), a fighter cannot launch from the shuttle bay (or launch tube) of a tractorized ship because there is insufficient space to complete the maneuver. See also (G7.98). Exceptions: (G7.9432), (G7.90), and (C13.947).

**(G7.942)** Units (booms, shuttles, PFs, ships docked to bases) can "escape" under the provisions of (D21.4) from a ship held in a tractor beam because the tractorized unit's explosion weakens the tractor link.

**(G7.943)** A unit being held in a tractor beam cannot launch seeking weapons except at the holding unit (regardless of their relative size). This is because those weapons lack the power to escape the tractor beam, but if they are moving toward the holding unit, they don't have to break away from the beam to reach their target. A scout (G24.23) or wild SWAC or PFS cannot attract a drone held in a tractor beam in this manner.

**(G7.9431)** Seeking weapons (including plasma torpedoes) launched and targeted on the tractorizing unit must be launched facing that unit and must move directly toward it by the shortest possible route, using hexes along the direct line of fire.

**(G7.9432)** Note that as suicide shuttles and scatter-packs are seeking weapons, they cannot be launched except if targeted on the holding unit. (They *can* be launched at the holding unit, even though shuttles and fighters that are not configured as seeking weapons *cannot* be launched.) These seeking shuttles, being unmanned, can function in the stress of the tractor field where a pilot could not. Weapons released from a scatter-pack can only be targeted on the holding unit (and SPs probably will not have sufficient standoff distance to release their drones).

**(G7.9433)** While on the map, such seeking weapons as described herein will be carried with the two units while they are moving under (G7.36). Those weapons cannot be rotated (and are not considered to be held) unless tractorized separately. Seeking shuttles could suffer destruction by "death dragging" (G7.54). Note that a unit nominally in the "tractor tunnel" between two units can be tractorized separately and held by either of the units or a third unit.

**(G7.9434)** Note that this section (G7.9433) does not apply to plasma torpedoes (which cannot be tractorized), but see (G7.91). Note also that despite similar titles "anti-drones" (ADDs) are direct-fire weapons and are not drones, hence they are not restricted by this rule.

**(G7.944)** Fighters, shuttles, seeking weapons, pods, etc. launched (or released or dropped or whatever) by the tractorizing unit are not affected by the tractorizing unit's tractor. They gain no benefit (they cannot "ride" the tractor to the target) and suffer no penalty.

**(G7.945)** Mines can be laid by a unit held in a tractor beam. The mine will NOT be carried along by a tractor between two ships as a drone would be under (G7.9433).

**(G7.95) POWER:** A unit being held cannot transfer power to any other unit including the towing/holding unit unless "docked;" see for example: (C13.41), (C13.55), (C13.952), (C14.0), and (R1.10B4).

**(G7.96) NON-COMBINATION:** The systems (including shields) of the two units joined by a tractor beam are not combined by virtue of the tractor link. Those systems may be combined if the rules so provide, for example if the units are docked as in (C14.0) or (G14.0). Tractor beams will often be a prelude to or a part of a docking arrangement, but it is the docking, not the tractor beam, which creates any combination, and not all forms of docking do so.

**(G7.97) LOCK-ON:** A unit held in a tractor beam may be locked-onto and fired at separately by enemy units.

See (G7.412) for lock-on between linked units.

**(G7.98) WILD WEASELS:** A unit being held in a tractor beam cannot launch a WW due to (G7.94). This is why plasma-armed ships (and drone-armed ships with double control and fast-firing racks) strive to achieve the "Gorn Anchor" (in which the target is held in a tractor beam when the torpedoes are launched). Exceptions: Docked units (C13.947) and tractorized bases (G7.90).

**NOTE:** A unit protected by a WW cannot be tractorized; see (J3.452).

**(G7.99) CLOAKED UNITS:** A cloaked unit held in a tractor beam is particularly vulnerable as it cannot fire its own weapons while most of the advantages of the cloak are lost. For this reason, whenever a ship is hunting a cloaked unit, any temporary lock-on is used as an opportunity to establish a tractor beam.

**(G7.991)** The ship attempting to establish the tractor link must have a lock-on to the cloaked unit and must fulfill all requirements [except (D6.37); see (G13.303)] to establish a tractor link. (The true range, not the effective range, is used.) Once the link is established, the tractorizing ship will have a lock-on to the cloaked ship (G7.412) without rolling to retain this lock-on (G13.331).

**(G7.992)** Any unit with a tractor beam attached to a cloaked unit is exempt from the double-range penalty (G13.301) in regard to that particular unit. This is because it automatically has a lock-on (G7.412) and the double-range penalty is based on a lack of a lock-on.

**(G7.993)** Any unit with a tractor beam attached to a cloaked unit is exempt from the +5 range penalty (G13.302) with regard to that unit. Even with a tractor, (G13.37) still applies.

**(G7.994)** The fact that one unit has a lock-on to a cloaked unit does not confer any benefits to or cancel any penalties against units allied to the tractorizing unit.

**(G7.995)** This rule (G7.99) does not apply to a tractor beam used to hold two units in a docked configuration. See (C13.949) and (G13.46).

## **(G8.0) TRANSPORTERS**

Most starships in the game are equipped with transporters which are used to move personnel and equipment from one point to another over short distances. Transporters may be used in this game to transfer officers, evacuate crews, and/or transport boarding parties.

On a starship, most transporter activity involves administrative personnel movements. In the combat sequences in Star Fleet Battles, most transporter activity involves sending Marines onto enemy ships.

### **(G8.1) GENERAL RULES**

**(G8.11) GENERAL:** Transporters are capable of picking up people and moving them to their location, or of transporting people at the location of the transporter to another location, or of transferring people from one location to another. There does not have to be a transporter unit on both ends of the transfer. Exception, (G13.421); see also (G19.47) for cases where two transporters are needed.

**(G8.111)** Transporting may be done during any impulse. This is done during the Marines Activity Stage of the Impulse Activity Segment. See Annex #2.

**(G8.112)** Each transporter may be used only once per turn. A given transporter cannot be used twice (on two consecutive turns) within 1/4-turn. Exception: (D21.3).

**(G8.113)** A single transporter can, in a single operation, pick up an object at one point and deposit it at another, without ever bringing it to the location of the transporter itself. (This is known as the "Bouncing Marines Tactic.") This must be done within the rules; it must be legally possible to transport something to or from both locations. It is not necessary (G8.21) for there to be a line-of-sight from the original location to the destination; it is necessary for there to be an unblocked line of sight from the transporter to both locations. In this case, the actual origin of the transported item is the origin for the first half of the operation (the unit with the transporter is the destination), then the unit with the transporter becomes the new origin and the ultimate destination is the destination for the second half of the operation. Note that this is a single operation conducted in a single impulse. The items or personnel being transported cannot stop at the transporter without requiring a second transporter operation. This cannot be used for hit-and-run raids (D7.8) as the two halves of the operation consume all of the available time. This rule cannot move explosive ordnance (G25.3).

**(G8.12) SSD:** Each box marked "TRAN" on the SSD represents one transporter. As with all systems, a ship must have undestroyed transporters to use them.

**(G8.13) ENERGY:** It requires one unit of energy to operate up to five of a given ship's transporters. If a ship has 6-10 transporters, two units of energy must be allocated if all are to be used. When using fractional accounting (B3.2), each transporter requires 1/5 point.

**(G8.14) RANGE:** The maximum range of transporters is five hexes.

**(G8.15) RESTRICTION:** Transporters can never be used to beam enemy personnel or objects (including shuttle pilots, cloaking devices, etc) without their permission (due to the special security systems involved). A hit and run raid, however, could result in captured crew units [or other objects] being transported at phaser-point. Captured equipment can be transported as friendly equipment could be.

**(G8.16) CYCLE:** A given unit or object cannot be transported twice within a period of 1/4-turn. Hit and run raids form a partial and limited exception to this rule, in that the attacking marines are transported to the target and back again during the same impulse.

**(G8.17) FIRE CONTROL:** The unit operating the transporter must have a lock-on to both the origin and destination of the transporter action; see (D6.623). (Obviously, the transporter always has a lock-on to itself.) Exceptions include escape (D21.3), friendly cloaked units (G13.421), and docked ships (C13.955) or (C13.45).

Units using EM cannot use transporters; see (C10.52).

## (G8.2) THE EFFECT OF SHIELDS ON TRANSPORTERS

**(G8.21) BLOCKAGE:** Transporters will not function through shields. Transporters work on a direct line from point to point. To determine which shield must be dropped or destroyed in order to use transporters, use the same rules of sighting as are used for direct-fire weapons.

See (D10.52) for the effect of PA panels on transporters.

See (C13.955) and (C13.42) in the case of docked units.

The illustration at right shows the hexes to which a Federation CA (or any ship) with heading "A" could operate its transporters after dropping the #2 shield. See the examples below for cases of ship-to-ship transporting.

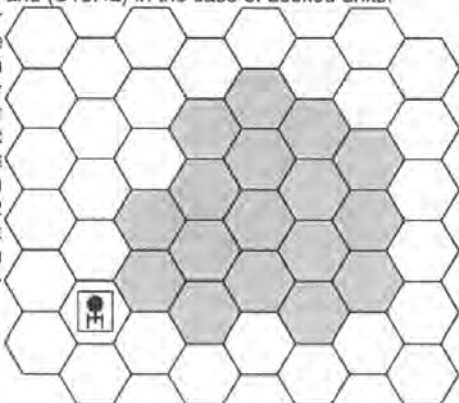

**EXAMPLE, PART I:** In the illustration below, a Federation cruiser is in hex 0911 while a Klingon D7 is in 1110 and a Klingon D6 is in 1111. The Federation ship fires photon torpedoes (overloaded with all but one point of available reserve power) at the D7, scoring two hits with overloads and some of the phasers, destroying the #5 shield. Consulting the records of the scenario, the Federation player observes that most of the marines (boarding parties) from the D7 were transported to a nearby planet earlier.

The Federation player, taking advantage of the shortage of Klingon marines, wishes to board the D7 (which is almost undamaged except for the down shield) in an attempt to capture it. The Federation ship drops its #2 shield (the one facing the D7) and applies his reserve power to the transporters in order to do this.

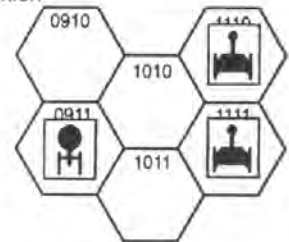

**(G8.22) DROPPING SHIELDS:** Players may, at their option, voluntarily drop any specific shield to facilitate the use of transporters, but the shield in question will remain down for at least one-quarter turn after it was dropped. See (D3.51) for the detailed procedure.

**(G8.23) GENERAL REINFORCEMENT:** General shield reinforcement will block the use of transporters, even through shields that are voluntarily dropped or destroyed by damage.

If a player announces he is trying to transport boarding parties onto an enemy unit, and the target unit still has general reinforcement shielding power active [or creates it with reserve power (H7.344)], the attempt fails with no loss or damage to either side. However, as each transporter may only be used once in a turn, no further attempt could be made with that specific transporter until the following turn. Note that reinforcement can be dropped, as shields can, under (D3.55). A minimum of one point of shield strength (not necessarily energy) is required to block transporters. This includes general reinforcement.

**EXAMPLE, PART II:** In the illustration above, the Federation player declares a transporter action against the D7 in 1110. The D7 then uses two points of reserve power to create one point of general shield reinforcement (H7.341), blocking the transporter action. The Federation player could, on a later impulse, fire a phaser or some other weapon to destroy this one point of general shield reinforcement. As it happens in this case, the Federation CA has no more weapons available to be fired at the present time.

**(G8.24) SHIELD DETERMINATION:** In the event that the line of sight passes exactly through the junction of two shields, the exact facing shield must be determined.

**(G8.241)** If the destination had no shields, or had two adjacent down shields (e.g., the #2 and #3 on the Federation CA in the illustration), the shield of the destination would not be relevant and the unit using the transporter could drop either of the two shields in order to facilitate the use of transporters.

**(G8.242)** If the destination has shields, the two units (origin and destination) determine their facing shields by (D3.4).

**EXAMPLE, PART III:** In the illustration, the D6 in hex 1111 now (on the next impulse) wishes to board the Federation CA through the down #2 shield. Using (D3.4) to determine the actual line of fire, the D6 captain notes that he must be going faster than the CA in order for the line-of-sight to pass through the CA's #2 shield. If that were the case, the D6 would drop its #5 shield and conduct the operation. In this case, however, the D6 is going the same speed as the CA and the shield resolution procedure in (D3.4) proceeds all the way to (D3.43) step C3, which allows the Federation player to decide which shield was "hit" by the transporter. The Federation player, being no fool, selects shield #3 and transporter action is impossible.

However, the Klingon D6 captain is not entirely stupid either. After briefly considering the idea of an unplotted mid-turn acceleration (C12.24) and discarding it (because he has only one point of reserve warp power available and that would leave no power for the transporters), the D6 captain drops his #1 shield (facing the D7). The D7 then drops his #4 shield (facing the D6) and drops the one point of general shield reinforcement. The D7 then uses its transporters (with the last point of reserve power) to pick up five boarding parties from the D6 and deposit them on the Federation CA, using (G8.113). Moreover, the D6 uses its point of reserve power to operate its five transporters, moving five more boarding parties to the D7 to guard

against counter-boarding by the Federation CA. Humiliated at being outsmarted by these two Klingons, the Federation captain re-evaluates his career options.

### (G8.3) OPERATIONS

**(G8.31) COMBAT RATE:** When sending boarding parties into an active combat situation [including boarding party combat (D7.0), ground combat (D15.0), or on a hit and run raid (D7.8)], each transporter can transport only one boarding party at a time. (This is much less than the administrative rate. The difference is that the troops must have their weapons armed and at the ready and must be physically facing the appropriate directions in a combat stance. This takes considerably more room than troops standing at attention in a squad formation.)

**(G8.32) NORMAL (NON-COMBAT) RATE:** Each transporter can perform one action per turn. Each action can transport one or two crew units, or their equivalent in boarding parties, passengers, deck crews, etc. (Four boarding parties equal two crew units, etc.) This cannot be into a "combat situation," i.e., into an active boarding party (D7.0) or (D16.0) engagement or a non-remote area of a ground (D15.0) battle.

**(G8.321)** Each transporter could, instead of crew units, transport one T-bomb (M3.22) or a certain amount of cargo (G25.0).

**(G8.322)** Troops can be sent into combat situations (i.e., into a ground combat location (D15.0) or into a ship in which combat is taking place) at this higher non-combat rate. They could not fight offensively on the turn of their arrival; they could become casualties on that turn. No more troops can be sent by the non-combat rates (total) than there are active troops (not under this or other restrictions) in the enemy-held area.

**EXAMPLE, PART IV:** The D7 transported five boarding parties onto the CA (above). After boarding party combat at the end of the turn, three survived. The D7 could use three transporters to send three "combat rate" boarding parties and then, on the next impulse, use the other two transporters to send six "non-combat rate" boarding parties (because six unrestricted boarding parties are there to screen them). As the two transporters used for non-combat rate transfers had a total capacity of eight boarding parties, they could have transported two more than they did had there been more troops on board to screen the arrivals. If another D7 arrived, it could use four transporters to send four "combat" boarding parties and (on the next impulse) its fifth transporter to send four at the "non-combat" rate.

**(G8.323)** The non-combat rates cannot be used to create a combat situation, i.e., the first units transported into an enemy-held area cannot use the non-combat rate. A "beachhead" must first be established by boarding parties transported at the combat rate. The non-combat rate cannot be used until one full turn (32 consecutive impulses) after boarding parties arrived (by whatever means), and only if boarding parties have survived on the enemy-held area for that entire time. Exception: (G8.33).

**(G8.33) EMERGENCY RATE:** In an emergency situation (D21.3) when a ship is being completely evacuated, each transporter could carry four crew units (or their equivalent in boarding parties, deck crews, etc.). If transported to an enemy vessel, such crew units would surrender immediately; exceptions (D21.34) and (G22.223).

**(G8.34) LIMITATIONS:** There are some objects which cannot be transported.

**(G8.341)** The following cannot be transported: ships, shuttles (including fighters), PFs (including interceptors), direct-fire weapons (e.g., photons, disruptors, hellbores), seeking weapons that have been launched (unlaunched drones can be transported as cargo), previously-laid mines, planets, asteroids, other terrain features, monsters, or bases.

See also (G8.15) for additional prohibited items.

See also (G25.0) for cargo transfers.

**(G8.342)** Andromedans (in Module C2) are the only race able to transport a "ship," and they can only transport their own ships. See (G19.4).

**(G8.343)** Transporters cannot transport part of an object; they must move the entire object. Thus, you cannot transport the phasers off of an enemy ship or the back half of an enemy fighter a hex or two away

from the front half. Exception: Ground combat vehicles are designed to be transported in two sections (G25.221).

**(G8.344)** Transporters cannot remove weapons or ammunition, such as drones from a drone rack or chaff pods from a fighter.

### (G8.4) CAMPAIGN FUNCTIONS

In some campaign games, players may wish to assume that they personally are on board a given ship. (The logical extension of this is that if that ship is destroyed, they cannot participate further in the game. While this works well enough in large multi-player games, in one-on-one games, it is, of course, pointless.) Using transporters, it is possible to "beam" yourself from a doomed ship to one that (you hope) will survive the scenario.

## (G9.0) CREW UNITS

### (G9.1) ASSIGNMENT

Each ship type is assigned a number of "crew units," each representing about 10 people (Klingons, Gorns, or whatever).

**(G9.11) RECORDS:** At their option, players may keep track of crew units for victory points. At the time the ship is destroyed, all crew units still on board perish. See (G9.3) and (D21.0).

**(G9.12) TRANSFERS:** When transferring crews from ship to ship, add any crew units taken from one ship to the amount carried by the ship they are transferred to. Example: at the start of a given turn, one ship has 32 crew units, while another has 31. During the course of the turn, 4 crew units are transferred from the second ship to the first. At the end of the turn, the first ship will have 36 crew units and the second will have 27.

**(G9.13) EVACUATIONS:** When evacuating a ship, crews may be transferred to another ship, base, planet, or other survivable habitat. Administrative shuttles (G9.14) can also be used to evacuate crew units. Evacuations might be conducted under (D21.0) or within the normal rules (perhaps because a ship is not expected to survive).

**(G9.14) SHUTTLES:** One administrative shuttle may carry one crew unit (J2.211). There are sufficient supplies on board to last the inhabitants several hundred turns.

**(G9.141)** Administrative shuttles can be "overcrowded" during emergency situations. A shuttle can carry two crew units, but all will perish if the shuttle has not landed in an environment where the passengers can debark within 20 turns due to the overload on the environmental systems. If the shuttle is crippled while overcrowded, the passengers become casualties (one unit is killed, the other is wounded). If not using (G9.23), wounded are killed.

**(G9.142)** Administrative shuttles can be "very overcrowded" in extreme emergencies, carrying up to three crew units. All will perish if the shuttle has not landed in an environment where the passengers can debark within 10 turns due to the extreme overload on the environmental systems. If the shuttle is damaged while very overcrowded, the passengers become casualties (one unit is killed, the other two are wounded). Only uncrippled shuttles can be used in this role, if the shuttle is crippled while overcrowded, its remaining time before critical overload is halved, rounding fractions up, e.g., if the shuttle had five turns remaining when it was crippled (not counting the current turn), it would have three turns remaining after being crippled. The casualties for damage scored to the shuttle are only scored when the shuttle is crippled.

**(G9.143)** Various other non-combat shuttles (e.g., the ground assault shuttle) carry passengers by the same rules as administrative shuttles. These are noted in their unit descriptions. The large heavy transport shuttle (R1.F5) carries twice as many as the admin shuttle.

**(G9.15) NUMBER:** Crew units are assigned by the MASTER SHIP CHART and noted on each SSD. See (G11.23) for an exception.

**(G9.16) CASUALTIES:** Each crew unit killed in combat (on a unit that is not destroyed) scores 1/4 BPV point (added to the opponent's score), and each crew unit saved (by friendly forces) from a unit that

was destroyed reduces the points received (by the opponents) for destroying it by 1/4 point. Captured crew units are worth 1/4 BPV in addition to the BPV of the ship. Stunned and wounded (G9.23) crew units do not count as casualties (but could be considered prisoners).

**(G9.17) SHUTTLE CREWS:** Shuttle and fighter crews are part of the ship's crew.

**(G9.18) PF CREWS:** PF crews are not counted as part of the crew of their PFT. These crews can abandon their PF (by various means provided in the rules) and be merged into the crew of the PFT (or base, or whatever). See (K2.36).

### (G9.2) CASUALTIES

**(G9.21) CAUSE:** Every tenth internal damage point scored on a ship kills one crew unit. See also (D7.21), (G17.25), and (J4.811). If the ship is destroyed, see (G9.11). Exception: (G9.231).

**(G9.22) SURVIVORS:** The last crew unit and the last two boarding parties (in effect, two crew units) cannot be destroyed by internal damage scored against the ship. (There would almost always be survivors.) Monsters that attack crew units directly (rather than by damaging the ship) are exempt from this rule. See (SM6.47).

**(G9.23) WOUNDED CREW UNITS (Optional):** Crew units might be wounded by various means.

**(G9.231)** If using this rule, one half of the casualties caused by various rules [e.g., (G9.21), (G9.142), (D7.21), (D7.4), (G17.25), (P15.1), (J4.811), etc.] are considered wounded rather than killed (round fractions up).

**(G9.232)** Wounded crew units are unable to function for the remainder of the scenario, but will recover within 24 hours. This is usually enough time for the next scenario. If insufficient time will be available for recovery during a campaign, this will be provided in specific scenario rules.

**(G9.233)** Wounded and dead crew units can be cured by a Legendary Doctor (G22.611).

**(G9.24) OTHER CAUSES OF CASUALTIES** may be specified as special scenario or terrain rules. See (SM6.47) and (P15.1).

### (G9.3) RECORD KEEPING

**(G9.31) CREW UNITS:** The number of crew units on a given ship includes the boarding parties and deck crews. Two boarding parties or deck crews equal one crew unit. It is desirable to keep track of which crew units on a given ship are boarding parties, which are deck crews, and which are general crew.

**(G9.32) EXAMPLE:** A Kzinti CV has 50 crew units. Of these, 10 represent the 20 boarding parties and 6 represent the 12 deck crews. If the ship were to receive 53 internal hits, 5 of the crew units would have been killed. In addition, 5 boarding parties would also be killed, but since the first 4 boarding party casualties (D7.21) are not counted, only 1 is killed. (From this point, every 10 internals will kill a boarding party.) In addition, 5 fighter boxes were destroyed, killing 5 deck crews. The combined boarding party and deck crew casualties represent 3 more crew units killed for a total of 8. After receiving this damage, the ship has 42 crew units, of which 9-1/2 represent the 19 boarding parties and 3-1/2 represent the 7 remaining deck crews. Note that after the first 40 internals, every 10 internals from that point kills a crew unit AND a boarding party.

### (G9.4) MINIMUM CREW

All ships require a certain number of crewmen to be operated, even at a minimum level.

**(G9.41) REQUIREMENTS:** The minimum crew for each ship depends on the size of its original crew, as follows:

Original crew	Minimum crew
1-4	1
5-8	2
9-12	3
13+	4
Starbase	24

**(G9.411)** If the crew of a ship is reduced below this level by enemy action or by evacuation, or if the skeleton crew beamed aboard a captured ship is less than the specified size, it is considered to be "undermanned." See (K1.31) for casualties to PF crews.

**(G9.412)** Captured ships require a minimum crew to function; see (D7.51).

**(G9.413)** For PFs (K1.31) the minimum crew is the original crew. These units are easily destroyed and have only enough crew to operate the systems.

**(G9.414)** Boarding parties and deck crews do not count toward satisfying the minimum crew requirement, but can be converted to crew units in some cases; see (G9.431).

**(G9.415)** Legendary officers can substitute for crew units in fulfilling the minimum crew requirement; see (G22.121).

**(G9.416)** Non-crew passengers cannot be counted toward fulfilling the minimum crew requirement. Passengers are noted on the MASTER SHIP CHART under crew units as Crew + Passengers; e.g., 4+30 on the Federation Starliner Pod (R2.9). Some scenarios may specify that the passengers are replacement crew units and do qualify as crew.

**(G9.42) RESTRICTIONS ON UNDERMANNED SHIPS:** If a ship is undermanned, it cannot operate any equipment except power producing systems (engines, APR, batteries), control systems, sensors, scanners, and shields.

**(G9.421)** It can move, but maneuverability is affected; the turn mode is increased by one. One crew unit can be assigned to "movement" and conduct all normal movement, turning, and sideslips, but a second unit would be required to perform an HET. There is no effect on nimble status or EM.

**(G9.422)** Each crew unit on board can operate one undestroyed systems box on the SSD (a weapon, tractor beam, lab, etc.). The cloaking device requires a crew unit. UIM, aegis, improved drone control, and DERFACS do not require an extra crew unit. An SFG requires one crew unit, not two (G16.52). This one system per crew unit is in addition to the systems listed in (G9.42).

**(G9.423)** Computer-controlled ships (G11.23) are not subject to the minimum crew rules.

**(G9.424)** Crew units transported to an undermanned ship during a turn count as crew on that ship (if sent for that purpose) during the Energy Allocation Phase that is more than 32 impulses from the point at which they arrived on the ship. Thus, crew units transported aboard between Impulse #2 and Impulse #32 of Turn #5 do not count as crew on the ship until the Energy Allocation Phase of Turn #7. Crew units transported over on Impulse #1 of Turn #6 count as crew during the energy allocation phase of Turn #7. This applies for (D7.51) in manning a captured ship.

**(G9.43) SPECIAL CREW UNITS:** Boarding parties and deck crews cannot be counted toward the minimum crew requirements.

**(G9.431)** Since the last two boarding parties cannot be destroyed by damage scored on the ship (G9.22), it would be possible for the ship to have boarding parties remaining when the ship is reduced to or below a minimum crew. In this case, the owning player may disband the last two boarding parties (convert them to one general crew unit) to satisfy the minimum crew requirement. Once converted, they cannot be converted back into boarding parties, and their "last two boarding parties" exemption (G9.22) no longer applies. Deck crews



(J4.81) can be converted to general crew units at any point, but cannot be converted back into deck crews.

**(G9.432)** Boarding parties on an enemy ship (even if they have captured it) cannot be converted into crew units. See (D7.51).

**(G9.433)** Units specifically designated as ground troops (found only in Module M) cannot be converted into crew units. Fleet marines have at least minimal crew training and, when combined with a few "real" crewmen, can get the job done. (Marines are boarding parties.)

**(G9.44) UNCONTROLLED STATUS:** The effects of being undermanned are not cumulative with being uncontrolled (G2.2). The more severe penalty applies in each case.

**(G9.45) CAMPAIGN EFFECTS:** In the case of a Federation heavy cruiser with a normal crew of 430, only about 40 are actually required to operate the ship. The remainder include the marines (who guard things and provide boarding parties), engineers (who repair things that break down or wear out or perform preventive maintenance to keep that from happening), and scientists (who conduct experiments and make up landing parties to survey newly discovered planets). While a ship might be able to complete a battle with only a few dozen crewmen, it could not then proceed on a multi-year survey mission. See (G1.23) in the case of computer-controlled ships.

**(G9.451)** Ships with reduced crews may have various penalties specified elsewhere in the rules of this and other SFB products.

**(G9.452)** Ships with less than 1/2 of their original crew (not counting boarding parties, passengers, or deck crews in the original or remaining crew) conduct (D9.4) repairs with an assumed maximum damage control rating of "2" regardless of the actual damage control rating, and no repairs to the damage control track can be made.

## (G10.0) THE THOLIAN WEB DEVICE

The Tholians are known to operate a highly developed tractor beam system generally referred to as the "web." This device is used both to capture enemy ships and to restrict movements and maneuvers. While based on tractor technology, it is not a tractor beam; web generators cannot be used as tractor beams and web produces no tractor effects.

The Tholians have been known to maneuver asteroids around their bases as anchors for webs. Laying webs around these stations thus renders them invulnerable to most weapons, unless the attacking ships allow themselves to be trapped in the web so that they can fire out of the web hexes. In some cases several layers of web are placed around a base, creating the famous "Tholian three-tiered wedding cake." Forces attacking such bases must place themselves into the outermost layer of the web so that they can attack (and destroy) the ships reinforcing that web, then must endure Tholian fire until the web loses enough strength that the ships can advance to the next web and repeat the process. If the attacker has all of his ships trapped in the web and the Tholian can destroy or damage enough of them to create a blind spot where a ship can power that web, the attackers will all be trapped. The procedure is somewhat similar to peeling an onion, and equally as unpleasant.

Players may utilize various unused counters to represent web. Web counters are provided in Star Fleet Battles Captain's Module R4.

Web generators are marked "WEB" on the SSD and are destroyed on "Flag Bridge" hits.

### (G10.1) TYPES OF WEBS

The device can form two types of web: linear or globular.

**(G10.11) LINEAR WEB:** A linear web extends between two anchor points (G10.13). These may be asteroids, anchor buoys, or ships (including, possibly, the ship or ships that laid the web).

**(G10.111)** If formed between or by two ships, they must begin in adjacent hexes and move apart in a straight line. Later if one ship (or both ships) enters an asteroid (or other qualifying anchor terrain) hex, the web may be anchored to the asteroid hex by simply laying a web in the asteroid hex. (This anchor is assumed unless stated otherwise at the time.) A ship assuming anchor status in an asteroid hex could specify that it was (or was not) concurrently relieving the asteroids of this status. See (G10.1314) when relieving a destroyed asteroid of

this status. See (G10.115) for sideslips while laying web. The ship and the asteroid can simultaneously be anchors in the same hex.

**(G10.112)** If one ship lays the web, it must begin doing so in a hex with a valid web anchor [perhaps an asteroid (P3.34) or by laying a web anchor buoy (G26.0)], anchoring one end of it to that anchor. See (G10.1314).

**(G10.113)** If, at any time, a segment of web is not anchored on both ends, it dissolves instantly. Note the exception created by free-standing webs (E12.22).

**(G10.114)** A web cannot be anchored to a planet that has an atmosphere. A web can be anchored to a planet or moon without an atmosphere by the same procedure as anchoring to an asteroid. A web cannot be attached to an object on the surface of a planet with an atmosphere or to an object in an atmosphere.

**(G10.115)** The web must be laid in a straight line. A regular pattern of sideslips (3A, SS-B, 3A, SS-B) will be considered as a straight line, as will the straightest practical chain of hexes between two points. The web cannot be bent to touch itself at any point; each hex can only be adjacent to one or two other hexes, and if two hexes, they cannot be adjacent. Two segments cannot be joined if they would violate this rule unless there is a valid web anchor at the "corner." If that anchor is destroyed or loses its status, the web would collapse because the two linked segments could not exist without the "corner anchor." Globular web (G10.12) is of course an exception.

**(G10.116)** Web anchor (G10.13) status is governed by these rules.

**(G10.1161)** The ship can enter a web hex and announce it is assuming web anchor status, or another Tholian ship can move into its hex while laying web and anchor it to the ship. Anchor status can only be assumed or voluntarily dropped during the Ship Systems Function Stage and cannot be changed within 8 impulses. This status must be announced. If an anchor is destroyed, a Tholian ship within that web segment could assume web anchor status immediately (out of the normal sequence). [Anchor status would be adopted involuntarily if the ship became an anchor for cast web under (E12.21), even if less than 8 impulses after having dropped that status, but the ship could not voluntarily change status again within 8 impulses. Status would be changed involuntarily if the ship-now-anchor moved in a manner that was not legal for laying or extending web and the web collapsed.]

**(G10.1162)** Ships laying web serve as the anchor of that web unless and until they pass this duty to another anchor. If a ship laying web moves out of a web hex without laying web in the new hex, it has given up anchor status.

**(G10.1163)** A valid web anchor point (ship, shuttle, PF, asteroid, web anchor buoy) in a web hex cannot be tractorred, even in a zero-strength web (G10.24). A unit serving as an anchor cannot be displaced (G18.671). See (G16.682) for an anchor in stasis.

**(G10.1164)** If a ship serving as a web anchor is captured (D7.538), it immediately loses its status as an anchor.

**(G10.1165)** In order for a web to remain intact after an intermediate anchor point is lost (G10.117), the web between the two anchors must be a legal and valid web within the definitions of (G10.115). If the lost anchor formed a "corner" with the two web sections not exactly 180° apart, the web would collapse. A valid anchor point at a sideslip hex (G10.115) would not be a corner. Note that web laid with a consistent pattern of side-slips is considered to be a straight line for this purpose, even though several hexes along its length will not be exactly 180° apart.

**(G10.1166)** Certain shuttles can serve as anchors of zero-strength webs. See (G10.24).

**(G10.1167)** A ship serving as a web anchor cannot move except to lay, extend, or shorten the web. A ship might be required to stop before assuming anchor status. A ship or other unit serving as a web anchor cannot use EM (C10.51).

**(G10.1168)** There can be more than one anchor in a given hex.

**(G10.117)** If a section of web has several anchors, and one of them is destroyed or releases itself, the web section will collapse immediately unless it can exist as a valid web without that anchor. (For example, if there is an anchor to either side of the destroyed anchor and the two segments form a straight linear web, they can hold the section. If the end anchor is destroyed, the web will immediately collapse from that point to the next anchor.) Web strength points in a collapsed segment are lost; they do not flow into connected non-collapsing segments.

**(G10.118) EXTENSION OF WEBS:** Webs can be extended by either moving one of the anchor points or by laying an additional web to one of the anchor points.

**(G10.1181)** End anchor points which are self-mobile (i.e., ships) can simply move [maintaining the same pattern of sideslips as per (G10.115)] and lay additional zero strength web as per (G10.211). At the instant that this happens, the entire web strength must be recalculated, using the total number of web strength points and the new number of web hexes.

**Example:** A web 10 hexes long with a strength of 7 (total 70 strength points) is extended to 11 hexes in length. The 70 strength points are then divided by 11 hexes resulting in an overall strength of 6 points per hex with some fractional points left over (G10.31).

**(G10.1182)** Non-moving anchor points (e.g., web anchor buoys and asteroids) cannot be moved. To extend these webs, a ship must enter the end hex of the web, assume anchor duties (it could recover a web anchor buoy as per the rules), and then use the procedure in (G10.1181).

**(G10.1183)** An additional section of web can be laid to a given anchor point. At the instant that the ship laying the web lays web in a hex adjacent to the anchor point, the two web sections are joined and the strength of the web must be adjusted for the new length.

**(G10.1184)** The reverse of the procedure in (G10.1181) can be used to shorten (and effectively strengthen) a web. A ship serving as an end-anchor point would simply move into the adjacent web hex, shortening the length of the web by one hex. The total strength points would then be divided by the new shorter length and produce a higher effective strength. If this strength exceeds the limit of 35 points per hex, any excess strength points are lost. Should the web later be re-extended, the original laying cost must be paid again.

**(G10.1185)** Corner and intermediate anchor points cannot be moved. If their status later changes to that of an end anchor, they can be moved as above.

**(G10.1186)** There is no procedure by which a web can be divided into two segments or that a segment between two anchor points of a multi-segment web could be dropped. The closest a player could come to this would be for a ship serving as a corner anchor to drop its anchor duties, causing both segments to collapse (G10.117) and, perhaps, opening a gap in a much longer multi-segment web.

**(G10.12) GLOBULAR WEB:** A globular web is laid in a circle and is then anchored to itself. There is no way to convert a linear web into a globular web.

**(G10.121)** Two ships are used to lay a globular web. They must begin in adjacent hexes and move to form a circle of the web (for example, hexes 0804, 0905, 1005, 1006, 1007, 0908, 0808, 0708, 0607, 0606, 0605, 0705 form a globular web). A legal anchor point (G10.13) can be substituted for one of the two ships. Note that some units (G10.24) can only anchor web of zero strength. A zero-strength globular web in the process of formation can contain corners that would be illegal for a linear web. See (G10.125).

**(G10.122)** A globular web cannot contain two or more loops.

**(G10.123)** A globular web can be a circle or an oblong, but cannot contain convex angles (viewed from inside). When tracing the web in a clockwise manner, the web can only make right-hand turns, not left-hand turns. The webs shown below are illegal.

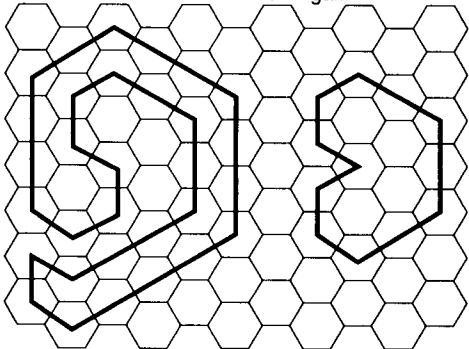

**(G10.124)** Two separate globular webs cannot touch each other. The two webs shown in the illustration below are illegal.

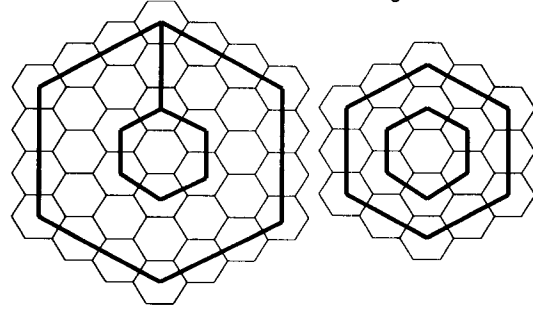

**(G10.125)** Globular web cannot be reinforced; it must remain at zero strength until the circle is closed and it is anchored to itself. Each globular web hex must be adjacent to two (only two) web hexes.

**(G10.13) ANCHOR POINTS** are used to hold each end of a web, giving the web energy something to pull against. See also (G10.116).

**(G10.131)** Certain units can serve as web anchors:

**(G10.1311)** Tholian ships can serve as anchor points (G10.116). They are self-mobile and able to extend or shorten a web (G10.118). Any Tholian ship (including PFs) can serve as a web anchor so long as the ship has a Tholian crew unit on board [with or without a web generator; Exception: see (E12.21)].

**(G10.1312)** Bases and web anchor buoys (G26.0) can serve as anchor points but are not self-mobile.

**(G10.1313)** Web spinners (G10.24) can serve as anchor points only for zero-strength web.

**(G10.1314)** Certain terrain types (large and small asteroids, moons, and planets without atmospheres) can serve as anchors and cannot move. While anchors of this type are seldom where you want them to be, they cannot be destroyed. An asteroid (or planet) used as a web anchor cannot be destroyed because a "sack of rocks" is as effective as one large rock for this purpose. However, if the "destroyed asteroid" is relieved of anchor duties (G10.111), the small rocks disperse and the asteroid can no longer be restored to that duty. Both large and standard asteroids can be anchors. If the victory conditions require destruction of the planet or asteroid, this can be achieved even if the "sack of rocks" remains. Note also (G10.114). The rings (P2.223) of a planet that has them can be used as web anchor points and operate as asteroid anchors for all purposes.

**(G10.1315)** Nothing can be used as an anchor unless specifically provided with this capability. For example, the ships and bases of Tholian allies cannot be used.

**(G10.132)** Globular webs do not require anchor points, except that an anchor point of any type can be used during construction (G10.121).

**(G10.133)** Anchor points for linear webs come in three types:

**(G10.1331)** End anchors are in the last hex of web on that end of a line of web. These points can be moved under (G10.118) to extend or shorten web. Additional web segments can be laid to these end anchors. Note that asteroids and other terrain cannot be moved, at least not during a scenario, but a ship could assume anchor status and move the end point of the web. (Special scenario rules may allow asteroids to be moved.)

**(G10.1332)** Intermediate anchors are units in web hexes which are not end hexes but which are within a segment of web which would be legal under (G10.115) when judged from the position of the web to either side. That is, intermediate anchors are those the loss of which would not cause collapse under (G10.117).

**(G10.1333)** Corner anchors are units in web hexes which are the junction of two separate web segments, each of which is legal under (G10.115) but the combination of which is not legal in itself. For example, a hexagonal web with asteroids in each of the six corners is not a globular web but is, instead, a connected group of six linear webs. Because they are connected, they are treated as a single entity for the distribution of strength points. However, the destruction of a corner anchor (not possible in the case of asteroids) will result in the collapse of the two web segments attached to it. The Tholians sometimes establish webs in this manner to allow some segments to be dropped for tactical reasons. Such a web cannot drop its anchors and become globular. Any dropped anchor would cause the connected segments to collapse.

**(G10.134)** By definition, any web anchor must be in a web hex.

**(G10.2) CONSTRUCTION OF WEBS**

**(G10.21) STEPS:** There are two steps to the construction of a web: The first is the actual laying of the web, and the second is reinforcing it. Both steps require that the laying ship or ships have at least one operable web generator on board (of each ship).

**(G10.211)** To lay web in a given hex, the laying ship moves into it and expends six units of energy (from any source). Web is then said to have been laid in that hex. All hexes of a given web must be adjacent to at least one other hex of that web (a globular web would, of course, have every one of its hexes adjacent to two and only two other hexes). The first hex laid is considered an exception to the part of this rule that requires each hex laid be adjacent to at least one other hex of that web.

**(G10.212)** To qualify to reinforce a web, a given ship must either be in a hex of the web or adjacent to it. Any Tholian ship with an operable web generator (or snare or web caster) may use the system to reinforce any web. Note exception: free standing web (E12.232).

**(G10.2121)** No more than four units of energy may be added to a web as reinforcement during each impulse of a given turn by a single ship. Any number of qualified ships can reinforce the web on a single impulse. Any amount of energy (assuming it is available) may be added to the web as reinforcing energy within the limits of the rules.

**(G10.2122)** To add reinforcing energy to a web, the reinforcing ship must be adjacent to or in it during any impulses in which power is added. The reinforcing energy is credited to web strength at the end of the impulse in which it is added.

**(G10.22) RESTRICTIONS:** Webs may not cross over or connect, or they are considered a single web.

**(G10.221)** Globular webs may not include more than a single loop. They need not be perfectly circular.

**(G10.222)** Any two adjacent web hexes are considered connected.

**(G10.223)** Webs cannot be moved. (There is one scenario that allows this, but only after the web has been in place for considerably longer than any single scenario.)

**(G10.224)** It is impossible for any web hex to be adjacent to more than two other web hexes. A corner anchor cannot be a junction of three separate web sections. Any effort to lay web in a hex which is adjacent to two other web hexes cannot succeed. The energy used in any such attempt would be lost. Exception: The web hex needed to close a globular web or link two sections of linear web can be laid.

**(G10.23) CONSTRUCTION CONDITIONS:** Construction of webs is under these conditions.

**(G10.231)** A ship can lay several hexes of web in a given turn, limited only by power. If a ship lays two or more hexes of web during a turn, they need not be in consecutive hexes of the ship's movement but must satisfy other rules of web construction.

**(G10.232)** No web (including connected segments of several webs) can be more than 30 hexes in length. If a web 30 hexes in length is extended (G10.118), the extension will simply fail to happen. (If the anchor point moved beyond this distance, it would lose its status as an anchor.) Two webs cannot be connected if they would then have a total of more than 30 hexes of web. The attempt to lay web in the hex between the two segments would simply fail.

**(G10.24) WEB SPINNERS:** Certain units may assist in the laying of zero-strength web by drawing it from a Tholian ship or base (much like drawing string from a ball). The units in the game designed to do this include Spider-I and Spider-III fighters, the EW versions of other Tholian fighters, Tholian MRS shuttles, Tholian heavy fighters, and Scorpion interceptors. Any ship which can lay and reinforce web can also lay zero-strength web.

**NOTE:** There are no web spinners in Basic Set.

**(G10.241) PROCEDURE:** A web spinning unit starts in the same hex as the web generating ship. As the two units move apart, a web of zero strength is created in the hexes through which they move. The ship must pay the cost of generating each hex of web laid (by either unit). See (G10.211).

**(G10.242) RESTRICTIONS:** Web spinning units can assist in laying web but cannot generate their own. They can only lay zero-strength web from a unit able to generate web. Their primary function is to string web from the generator to an anchor point. They can transfer their duties as an anchor point to another qualified unit or object in the same hex. Reinforcement energy cannot be added until the web

is anchored to a non-spinning unit. If the web-spinning or web-generating unit is destroyed before the web is otherwise anchored (unless another qualified anchor or spinner is in that hex and assumes the duty), the web collapses immediately. See (G10.43).

**(G10.3) STRENGTH OF WEBS**

The strength of a web is a function of the energy used to reinforce it and its size. (The initial laying of the web does not provide it any strength.) The maximum strength of any one web hex is 35; this limit does not increase with any advanced technology. Any excess fractional (or whole) points are lost.

**(G10.31) PROCEDURE:** Total the amount of energy added to the web as reinforcement, deduct any lost as deterioration (G10.41), and divide by the number of hexes in the web, ignoring all fractions. This is the strength of the web. The ignored fractions are not discarded; they may be accumulated and recalculated.

**EXAMPLE:** 23 units of energy have been added to a 10-hex web. Since  $23/10$  is 2.3, the strength of the web is 2 (the 0.3 is ignored). Later time, 8 units of energy are added, and the calculation is  $31/10$ , giving a strength of 3.1 which is rounded down to 3.0 (but the 0.1 is retained for future calculations just as the 0.3 was above).

**(G10.32) IMPROVEMENTS:** The Tholians continued work on their web technology and made improvements over the years.

**(G10.321)** By Y160, the Tholians made improvements that resulted in a more efficient method of adding energy to their webs. In scenarios after that time (Y161 and later), the strength of the web is equal to 1.5 times the strength calculated in (G10.31), ignoring any fractions.

**(G10.322)** The Tholians made another breakthrough in Y175. Starting with that year, the strength of the web is double that calculated in (G10.31), ignoring any fractions after doubling.

**(G10.33) STRENGTH:** The strength of a web will vary over time as more energy is added to it and as it dissipates. Energy must be allocated at the start of the turn (or be reserve power); any allocated but unused energy is lost. The specific unit that provides the reinforcing energy (G10.212) need not be announced.

**EXAMPLE:** A web five hexes long might have a strength of three at the start of a turn. During that turn, a ship moves adjacent to it on Impulse #4 and remains there for four impulses (since its speed does not require it to move for that many impulses). During that period of time, 16 energy factors could be added. Thus, the web had 15 energy points at the start of the turn and now (end of Impulse #7) has 31. The strength of the web at this time is six. Later (Impulse #9), a second ship moves by and spends two impulses adjacent to the web. It adds only six factors of energy (it can't spare more), bringing the web to 37 (strength 7) at the end of Impulse #10. An enemy ship enters the web on Impulse #12 and is trapped. It is moving at a speed of 24, so it will take it until Impulse #22 to have expended 7 movement points. During that time, other Tholian ships arrive and add more power. The original reinforcing ship returns on Impulse #14 and stays by the web, but it has only 9 units of power to add (46, strength 9 at the end of Impulse #16). A PC arrives on Impulse #20. The enemy will be free on Impulse #24 unless more energy is added. The PC adds 4 units on Impulse #20, making the total 50 (strength 10, escape on Impulse #26). It then adds 4 units on Impulse #21 (54, still strength 10, still escapes on 26). The PC then adds 3 units (the last it can, due to power limits) on Impulse #22. Total is now 57, and strength is 11. The enemy ship will escape the web on Impulse #27 unless another ship arrives to add more power to the web.

**(G10.4) DETERIORATION OF WEBS**

**(G10.41) DETERIORATION:** Web deteriorates over time. At the end of each turn, each web loses one aggregate strength point for each hex of web. (This will, in most cases, be offset by reinforcement energy.) Note that this will be 0.667 energy points from Y161-174 and 0.50 energy points in Y175 and later due to the effect (G10.32). See (G10.43).

**(G10.42) PROCEDURAL EXAMPLE:** At the start of Turn #6, a web that is 12 hexes long has 97 aggregate strength points, resulting in a strength of 8 (points per hex). During this turn, ships add a total of 27 points of energy to the web, giving it an aggregate strength of 124.

During the turn, the web was extended two hexes (now 14 hexes long). At the end of the turn, the web lost one strength point for each hex of length, or 14 energy points, giving it an aggregate strength of 110, which is divided over 14 hexes to result in an effective strength of 7.857 which is considered to be 7. [In Y175, the web would have lost only 7 points rather than 14 and the result of 8.36 would have yielded 16 points of web strength as fractions are ignored (G10.32).]

**(G10.43) NEW WEB:** A newly laid web hex is at zero strength (G10.3). It will dissolve in 7 turns (224 impulses) if not reinforced to strength one. Thereafter it can be reinforced as per the rules. This also applies to web that has deteriorated to strength zero.

### (G10.5) THE EFFECT OF WEBS ON MOVEMENT

**(G10.51) SHIPS:** The web is used to trap enemy ships or to restrict their movement. A ship which enters a web hex ceases movement until it leaves the web hex via (G10.511) or (G10.56) or the web deteriorates to zero strength.

**(G10.511)** For a ship (other than a Tholian ship) to leave a web hex, it must expend, over a period of 32 consecutive impulses, a number of movement points equal to the strength of the web. If it does, it moves out of the web (into an adjacent hex in the direction of movement within the normal rules) on the last such impulse.

**EXAMPLE:** A Klingon D7 enters a 24-point web hex during Impulse #14 of Turn #3, while moving at a speed of 12. The D7 then accelerates on Impulse #15 (this was planned in Energy Allocation) to a speed of 24. During Impulses #15-#32, it accumulates 14 movement points. During the turn, the Tholians increased the strength of the web to 26, but it deteriorated to 25 at the end of the turn. At the start of Turn #4 the Tholians increase the strength of the web to 28. The D7 continues moving speed 24 initially, and accelerates to speed 31 on Impulse #15, generating its 14th movement point on Impulse #18. However, this is a total of 36 impulses so the ship does not move on Impulse #18. On Impulse #24, the ship accumulates its 22nd movement point on Turn #4, and can count the 6 movement points accumulated during Impulses #25-#32 on Turn #3. Thus, the D7 moves out of the web on Impulse #24 of Turn #4.

**(G10.512)** A ship trapped in a web is not "stopped" for purposes of using an SFG (G16.31); the ship must cease generating movement points to be "stopped" for this purpose. See also (G16.68).

**(G10.513)** Webs reduce the effective speed (C2.45). Being stopped in a web while still "moving" does not allow WW launch because WWs use the maneuver rate (which does not include web effects).

**(G10.52) SMALL UNITS:** Shuttles, fighters, and seeking weapons move through a web using the same procedure as ships (G10.511). If the strength of the web exceeds their speed, they remain trapped.

**(G10.521)** If a seeking weapon enters a web hex that also contains its target, the weapon strikes the target immediately (as it would if the web were not there), ignoring the effects of (G10.593) in this case.

**(G10.522)** If a ship tractors a size-6 or smaller object in a web, the object will not be damaged by the ship's subsequent movement (although a friendly seeking weapon will go inert), but the tractor beam will break. The unit could be pulled out using (G10.56) with an assumed movement cost of zero, assuming it is not an anchor.

**(G10.523)** If a seeking weapon, on the impulse it could leave the web, makes an HET instead of actually moving, it is still in the web hex and while it has earned the right to leave the web hex on its *next* impulse of movement, if the web is strengthened in the interim the weapon may have to continue accumulating movement to leave the web. An HET performed earlier while in the web would not count as accumulated movement.

**(G10.53) THOLIAN UNITS:** Tholian units may move through webs without expending extra energy. Tholian auxiliaries (e.g., AuxCVs) count as Tholian units even if some were built by foreign powers.

**(G10.531)** Ships captured by or allied to the Tholians do not have this benefit. This ability can never be transferred to non-Tholians. (There is a solitary exception in the case of the TK5, which was built from the front half of a PC and the rear half of a Klingon F5. The Tholian portion of the ship provided the Tholian benefits.)

**(G10.532)** A Tholian ship, captured and operated by another race, will not have this capability. This includes freighters, monitors, auxiliaries, etc.

**(G10.533)** A Tholian unit can voluntarily "forgo" this ability. Such a unit announces it is "forgoing" its passage ability at the end of the Movement Segment of any impulse and can reverse this at the same point in any later impulse, but cannot change this condition within 8 impulses of a previous change. This condition and all changes to it must be announced.

**(G10.534)** Tholian ships could assume anchor status (G10.116) while in a web hex to avoid being tractor, dropping the status when ready to move out of the hex. A Tholian ship can adopt this status even while held in a tractor, but given the Sequence of Play (move, change anchor status, tractor beams), it would be possible for the Tholian ship to be pulled out of the web before having a chance to adopt this status.

**(G10.54) EFFECT ON WEB:** If a ship moves through a web by expending the requisite power, the web itself is not affected.

**(G10.55) LAUNCH:** If a ship (or a base, FRD, or shuttle) is in a web hex, anything launched or undocked from it is caught by the web until it expends enough power to escape, as if it had entered the web hex from a non-web hex. This also applies to ships undocking from bases or FRDs. **NOTE:** While webs were developed from tractors, they are not tractors for any purpose and (G7.94) does not apply.

**(G10.551)** A fast drone launched in a web hex would be destroyed at once (if the web was strong enough to inflict the required damage, and unless its target was in the same hex) due to (G10.593). Armor might allow the drone to survive if the web was not too strong; external armor could slow the drone down enough for it to survive.

**(G10.552)** A WW launched by a ship trapped in a web will function, but the ship will probably receive some collateral damage due to the lack of time for the WW to move away.

**(G10.553)** WW collateral damage (J3.3) will damage everything in the hex (except where noted), even if the hex is a web hex.

**(G10.554)** Two units in the same web hex can dock (if they could in a non-web hex). Formation of pinwheels (C14.0) is also possible.

**(G10.56) PULLING A UNIT OUT OF WEB:** One ship can attempt to pull another ship from a web with tractor beams by either of the following procedures. The pulling ship can be no more than one size-class smaller than the pulled ship; PFs cannot pull anything larger than a PF. The tractor link must exist for the entire time that pulling is taking place. A captured Tholian ship would be treated (by the Tholians) as an "enemy" ship. Anything not serving as an anchor, not just a ship, can be pulled out of the web. A drone or shuttle could only be pulled from a web by a stationary ship (G10.522).

**(G10.561)** The two ships can attach a tractor beam between themselves and operate as per [(G7.32) or (G7.36)] and (G10.511). If they have enough power to expend, they will be able to leave the web. This rule obviously cannot be used if the web is stronger than 31. (Movement must be in the same direction, and that direction is the direction that the two ships will move. One ship outside of a web could push another ship through a web, getting itself trapped in the process.) The tractorship must be in a hex adjacent to the tractorship. See (C2.112) for additional data.

**(G10.562)** The two ships in adjacent hexes (one in the web and one out of it) can attach a tractor beam between themselves (or to each other) and expend an amount of power (not movement points) equal to the strength of the web through the tractor beam. This power can come from any source, but must all be expended in a single turn. Either ship can provide the tractor link; only a ship maintaining a tractor link can provide power. The result is that the ship in the web is pulled into the hex of the "pulling ship" outside of the web during the Movement Segment of the last impulse of the turn. This is an exception to the rotation rules (G7.7). This can be done at extended range (G7.6), but will take more power. If done at extended ranges (G7.6), the power will be reduced appropriate to the longer range before being applied to pull the ship out of the web. The ship pulled from the web moves only one hex, which will not take it into the hex of the other ship if the tractor link was established at longer ranges.

**(G10.563)** The following procedure is used if one ship in a web hex is tractoring (or tractor by) an enemy ship in an adjacent hex outside of the web. The requirement that both ships be moving in the same direction (G10.561) does not apply in this case although the total movement energy (not movement points) must exceed the strength of the web. Extended tractor range (G7.6) cannot be used, although extended range could be used to hold the enemy ship and rotate it closer, at which point the procedure would apply. The trapped ship

can either maintain the tractor link and use the (G10.561) procedure, in which case the ships just move (rather than one ship being pulled into the other ship's hex) or the trapped ship can put power into the tractor link (if it is the ship maintaining the tractor), in which case it uses the (G10.562) procedure, and is pulled into the hex. If neither ship can (or wants to) break the tractor link, the situation is resolved as follows:

**(G10.5631)** If the trapped ship is expending more movement points than the enemy ship, and the trapped ship is the same size class or larger, the trapped ship has the choice of pulling itself out of the web (into the hex with the other ship) or pulling the enemy ship into the web (in his hex). If the trapped ship is smaller, neither ship moves.

**(G10.5632)** If the enemy ship is expending more movement points than the trapped ship, and the trapped ship is the same size class or smaller, and the total movement points of both ships are more than the strength of the web, the trapped ship is pulled out of the web (into the hex containing the enemy ship). If the trapped ship is larger, neither ship moves.

**(G10.5633)** If the enemy ship is expending more movement points than the trapped ship, and the total movement points of both ships is not more than the web strength, neither moves.

**(G10.5634)** In any of the above cases, the trapped ship could rotate the enemy ship using (G7.7). The enemy ship could rotate the trapped ship using (G10.562). Note that only the tractoring ship can control rotation, so the rotation examples assume that the rotating ship is the tractoring ship and the rotated ship is the tractorated ship.

**(G10.57) MANEUVERS BY TRAPPED SHIPS:** A ship or shuttle trapped in web cannot use erratic maneuvers (C10.24). It can use emergency deceleration (C8.0), HET (C6.0), and Tac (C5.0). It can turn in accordance with the turn mode for its practical speed (C2.411), even though it is not actually moving. A Tholian ship that has not forgone its ability to move through web (G10.533) is never trapped in a web hex or under these penalties. The sideslip mode is reset to zero when the unit leaves the web.

**(G10.58) DISENGAGEMENT:** A ship cannot disengage (C7.0) by any means while trapped in a web hex or when completely surrounded by web hexes. It must break free of the web hex before it can disengage. See (C7.125).

**(G10.59) DECELERATION CAUSED BY WEBS:** When a ship enters a web, it (in effect) decelerates because of the effect of the web. If this deceleration is particularly violent, it can cause damage to the ship.

**(G10.591)** If the ship loses 12 or more movement points (that is, if the ship is moving at a speed of 12 or more AND the web has a strength of 12 or more), the ship must roll for a breakdown as if it had made a high energy turn. The breakdown roll is made upon entry to the web hex. [The (C6.52) breakdown bonus must be used if available.] Any breakdown cannot cause tumbling. Any increase in web strength or ship speed after the ship enters the web hex has no additional effect on the chance of a breakdown.

**(G10.592)** Each point of speed lost (after the first 12) causes one point of damage on the ship's forward shield (or whichever shield entered the web first). See (G10.74) in the case of Andromedan ships. The ship cannot receive more damage than the amount of movement points countered by web, e.g., a ship moving speed 14 into a strength 30 web will only suffer (14 - 12 =) 2 points of damage. A ship moving speed 15 into a strength 13 web will only suffer one point of damage.

**(G10.593)** Drones and shuttles take one point of damage for each point of speed loss over 20. They cannot break down. Shuttles can only reach this speed by using warp booster packs (J5.0); as these packs cause damage scored on the shuttle to be doubled, the impact could be quite lethal. Seeking weapons strike their targets before this procedure is applied; see (G10.521) and (G10.551). The drone or shuttle cannot take more damage than the amount of movement points countered by web, e.g., a fighter moving speed 22 into a strength 30 web will suffer two points of damage [doubled to four points due to its warp packs (J5.0)].

**(G10.594)** PFs are treated as ships, but roll for breakdown and take damage after losing 20 movement points, rather than 12.

**(G10.595)** The cost of EM or an HET is not added to the speed for this purpose. This damage is based on effective speed (C2.45).

**(G10.596)** This condition applies only to ships entering a web hex from a non-web hex. This also applies to Tholian ships which turn off their web crossing (G10.533) ability while in a web hex.

**(G10.597)** A Tholian ship that had not forgone its ability to move through web (G10.533) would be undamaged by entering such a web but would be subject to damage if it adopted anchor status. In the case of a new web suddenly created by a web caster (E12.0), a ship traveling at high speed might prefer to risk a high energy turn or perform emergency deceleration rather than slam into the web.

**(G10.598)** Objects (including ships) linked by tractor to a unit entering a web hex are not directly affected by this entry. They are not damaged, and the tractor is not broken. Units rotated into a web hex (G7.7) take damage at their effective speed.

**(G10.6) THE EFFECT OF WEBS ON COMBAT**

**(G10.61) NON-THOLIAN WEAPONS:** No direct-fire weapons may be fired through a web hex. Direct-fire weapons MAY be fired into or out of web hexes. Note that a ship may fire direct-fire weapons from a web hex into an adjacent web hex. If the strength of the web is zero, this rule does not apply. If the line of fire passes exactly along the edge of a web hex, it is not blocked unless both hexes bordering that edge are web hexes. PPDs cannot obtain or hold a wave-lock through a web. Stasis field generators cannot function through a web (G16.68).

**(G10.62) THOLIAN WEAPONS:** Tholian ships may fire their phasers (not other weapons) through their own web hexes. The number of damage points scored by each phaser is reduced by one for each hex between the firing ship and the farthest web hex that the line of fire passes through (not just into), but the damage can never be less than zero. If several layers of web are crossed, use the one farthest from the firing ship. The illustration below shows the firing penalties for various combinations of webs fired through.

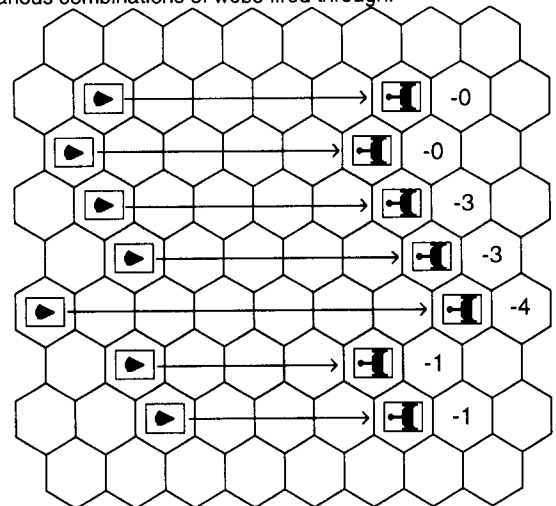

Ships captured by or allied to the Tholians do not have these benefits. This ability can never be transferred to non-Tholians. A Tholian ship, captured and operated by another race, will not have this capability. Phasers removed from Tholian ships and installed in non-Tholian ships do not have the Tholian ability to fire through webs.

**(G10.63) WILD UNITS:** The effect of a wild SWAC (J9.2) or wild PF scout (K1.756) does not extend through a web or along the edge of a web hex. The effect of a wild weasel does.

**(G10.64) SCOUTS:** Tholian web does not block any scout functions.

**(G10.65) PROBES:** Probes (for information or as weapons) can be fired into or out of a web hex (G5.22), but not through one.

**(G10.66) CONTROL:** Webs do not block the control of command-controlled mines (M5.2), seeking weapons (F, defense satellites (R1.15), MSS (M8.3), PFM (M8.33), death riders (K7.0), and Probe drones in monster scenarios (FD6.22).

**(G10.7) OTHER EFFECTS OF WEBS**

The following rules apply to webs with a strength of greater than zero. Anything not listed here or elsewhere (e.g., labs, identifying drones, tactical intelligence, communications) is not affected by webs.

**(G10.71) TRANSPORTERS AND TRACTORS:** Transporters and tractor beams cannot function through web hexes. They may function into or out of web hexes. They may be used between two adjacent web hexes, or between two non-adjacent web hexes so long as the intervening hexes are not web hexes. Ships can be rotated into but not out of web hexes; exception, see (G10.562). A ship that is serving as a web anchor cannot be tractorred; see (G10.1163).

**(G10.72) EXPLOSIONS:** When a self-destruction blast occurs near a web, the blast may enter the web hex but it will lose one point of its strength for each strength point of the web. The strength of the blast in hexes on the other side of the web is reduced by the strength of the web. If the blast takes place in a web hex, THAT hex gets the full effect while other hexes are reduced accordingly. **EXAMPLE:** A 17-point self-destruction blast occurs in a hex adjacent to a web; an identical blast occurs in a web hex. The web in this case is 10 points. The illustration below shows how many damage points would be scored on ships in each. The web is unaffected by the blast.

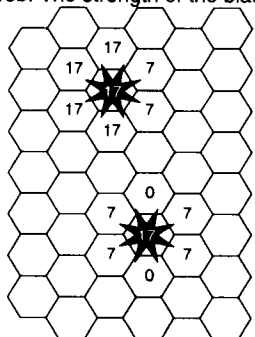

Each explosion is reduced separately, thus if two ships exploded for 17 points each in the same strength ten web hex during the same damage resolution step the damage in adjacent non-web hexes would be 14 and zero in adjacent web hexes.

**(G10.73) ESG:** An expanding sphere cannot be generated into or through a web hex. See (G23.85).

**(G10.74) PA PANELS:** Webs have no effect on power absorber panels (D10.0). If an Andromedan ship enters a web, it is affected by (G10.59) but does not absorb any power into its panels.

**(G10.75) TERRAIN:** Web hexes do not protect ships from asteroids in the same hex. Webs can be laid in asteroid, planet (no atmosphere), dust cloud, radiation zone, ion storm, or heat zone hexes. Webs cannot be laid in planet (with atmosphere) (P2.0), black hole (P4.0), pulsar (P5.0), star, or nebula hexes (P6.0). Webs cannot be anchored to a comet (P16.0) or a tournament barrier (P17.0).

**(G10.751)** Web affects variable pulsars (P5.0) and black hole gravity waves (P9.0) as it would self-destruction (G10.72). If a gravity wave passes over a web, there will be a corresponding reduced strength segment of the gravity wave from that point forward.

**(G10.752)** A web cannot be laid or cast within 10 hexes of a black hole (P4.0) but is otherwise unaffected by it. Web anchors cannot be pulled out of a web.

**(G10.753)** Ships trapped in a web might be pulled through it if the speed caused solely by the black hole was sufficient to overcome the strength of the web; see (C2.45) effective speed.

**(G10.76) MINES:** If a mine detonates in a web hex, it has full effect in that hex and is otherwise treated as a self-destruction explosion. A mine detonating adjacent to a web would be treated as self-destruction (G10.72). Multiple mine explosions are treated the same as multiple ship explosions, i.e., each is reduced independently.

**(G10.77) CLOAKS:** The case of a cloaked ship being exposed in a web (G13.45) cannot be used as an analogy. Entering a web hex does not affect passive fire control (D19.0), silent running (D17.75), wild weasels (J3.0), ECM (D6.3), and hidden ships (D20.0) and does not provide a lock-on for a ship that failed to achieve one (D6.12).

**(G10.78) DISPLACEMENT DEVICES:** See (G18.71) for the effects of web on displacement.

**(G10.8) WEBS SET UP BEFORE A SCENARIO**

It costs power to maintain webs (lots of it), and power ultimately costs money. Hence, webs are not maintained at maximum strength year in and year out on the off-chance that an enemy might decide to attack. Webs are kept at strength zero (using low-power generator buoys which do not function during combat) until a threat appears.

**(G10.81) WEB POINTS:** The value of web which was created before the scenario [as, for example, in scenario (SH6.0)] is calculated in terms of web points, each web point being equal to one hex of web at a strength of one (e.g., a web 7 hexes long with a strength of 10 would have 70 web points). A standard triple-ring web around a base [again, as in (SH6.0)] has 1,890 web points.

**(G10.82) COST:** Each web point is equivalent to 0.25 BPV points (or 472.5 points for a maximum-strength wedding cake).

**(G10.821)** Each large asteroid (P3.4) used as an anchor costs 25 points. (A wedding cake would need 12 for the outer rings, at a total cost of 300 points. Points can be saved by using a globular web.)

**(G10.822)** Web anchor buoys (G26.0) can be purchased to anchor web and deployed before the scenario begins. The cost is given in (G26.12). The cost of web anchor buoys deployed before a scenario begins are not included in the limit on Commander's Options (S3.2).

**(G10.823)** No points are received for web being destroyed.

**(G10.83) AT-START STRENGTH:** The strength of web at the point that the scenario begins varies with the weapon status. These rules assume that there are three layers of web, designated 1st (outer), 2nd, and 3rd (inner) in the order that the enemy will encounter them.

LAYER	WS-0	WS-1	WS-2	WS-3
1st	5	15	25	35
2nd	10	20	30	35
3rd	15	25	35	35
Total	420	960	1,500	1,890

**(G10.831)** The total line indicates the total number of strength points in a three-layer web with radii of 1, 3, and 5. In the event that the players decide to set up other web arrangements than a wedding cake, these strength point totals dictate the number of web hexes and web points which are available for purchase.

**(G10.832)** All webs set up before the scenario begins must be globular or anchored by objects other than ships or mobile units.

**(G10.833)** Webs set up before the scenario begins cannot exceed the maximum strength given for the 3rd layer. These strengths are maintained at WS-0 Conditions between scenarios by generator buoys which cannot function in combat conditions and cease to function once the scenario begins. In the case of the "buzz saw" (three spiral webs radiating from the base) all are treated as "2nd layer" webs.

**(G10.834)** The Tholian player may voluntarily reduce the strength of at-start webs to avoid paying the BPV penalty. As a tactical note, it would be better to reduce the strength of the inner web as this can be easily powered up by the base long before the enemy gets to it.

**(G10.835)** A surprised base (D18.0) would have zero-strength web.

**NOTE: RULES IN ADVANCED MISSIONS**

**(G11.0) SUPER INTELLIGENT BATTLE COMPUTERS:** These are computers which control the ship (leaving the crew to maintenance and making general policy decisions). They are superior to a normal crew in many ways, but have a tendency to fail and hence are used only experimentally. The computer also has a tendency to go berserk if it thinks the crew is trying to turn it off.

**(G12.0) SHIP SEPARATION:** Some ships have a capability to separate into two or more sections as an emergency survival maneuver. For example, the saucers of Federation ships and the booms of Klingon ships can separate from the rear hull.

**NOTE: The next rule in Basic Set is (G13.0) Cloaking Device.**

**(G13.0) THE CLOAKING DEVICE**

Most Romulan ships (and some Orions) are equipped with this device, which makes detection of the ship almost impossible. However, while the ship itself cannot be seen, the effect of its magnetic field on light from the background of stars can be seen and will give at least a general idea of where the ship is. This invisibility comes at a price: the ship cannot fire weapons while cloaked. Even worse, if the ship is accurately spotted, it could be badly damaged by enemy weapons while trying to uncloak.

Romulan ships use the cloaking device to make secret approaches to enemy forces, to escape after an attack, and to protect themselves while reloading their plasma torpedoes during a battle.

**(G13.1) OPERATION OF CLOAKING DEVICE**

The cloaking device is operated by these rules.

**(G13.11) OPERATION:** The cloaking device can be turned on or off during the Activate/Deactivate Cloaking Device Step of the Cloaking Device Stage of any impulse.

**(G13.111)** Turning the device on begins the fade-out procedure (G13.14).

**(G13.112)** Turning the device off begins the fade-in procedure (G13.15).

**(G13.113)** A cloaking device can only be turned on one time during each turn and can only be turned off one time during each turn. No unit can have more than one cloaking device.

**(G13.114)** If the device is activated or deactivated near the end of a turn, the fade-in/fade-out effect carries over into the next turn. This does not count against the next turn for purposes of (G13.113).

**(G13.115)** The player can stop/reverse the fade-in or fade-out process during any Cloaking Device Stage, but the ship must then fade back out (or in) the same number of impulses that it had already faded in (or out). The combined action counts as the only fade-in and fade-out allowed during that turn. The ship cannot stop at a point partially faded-in/out and await developments, but must either complete the process or reverse it. Once reversed, that specific fade cannot be reversed again. If a fade-in is reversed, the ship does not pay for a second activation of the cloaking device.

**EXAMPLE:** A Warbird turns its cloaking device off on Impulse #10 (+5), fading in during Impulses #11 (+4) and #12 (+3). During the movement portion of Impulse #13, Federation reinforcements arrive and the Romulan player decides to "take her down" (i.e., cloak) again, announcing this in the Cloak Stage of Impulse #13. Reversing his fade-in, the ship fades out on Impulses #13 (+4) and #14 (+5) and is fully cloaked on Impulse #15.

**(G13.116)** If a cloaked ship does not allocate energy for cloaking, it begins fade in during Impulse #1 of that turn. It does NOT become fully uncloaked immediately. Not allocating the energy to continue operating a cloaking device during Energy Allocation counts as turning the device off for that turn (G13.11); fade in begins on Impulse #1.

**(G13.117)** If the ship was cloaked on one turn and pays the energy during Energy Allocation to continue the operation of the device on the next turn, the ship remains cloaked. It is not exposed at the end of each turn while the captain reallocates the ship's energy.

**(G13.118)** A cloaking device may be involuntarily deactivated under certain circumstances: e.g., destruction by hit and run raid (D7.85), lack of power resulting from energy balance due to damage (D22.0). In these cases, the effect of being cloaked is lost immediately and fade-in begins on the next Cloak Stage. For example:

Impulse #20 Movement Segment: Cloaked ship strikes mine. Enemy achieves lock-on.

Lock-On Stage: Enemy rolls (G13.331) and retains lock-on. Marines Activity Stage: Enemy launches successful hit and run raid to destroy cloak. Ship is uncloaked.

Direct Fire Weapons Segment: Enemy fires at the cloaked ship, with the +5 range penalty from (G13.302) and the fire adjustment (G13.303) with the modifier in (G13.361), but not the no lock-on penalty (G13.301). The destruction of the cloaking device actually had little immediate effect as the enemy ship already had a lock-on.

Impulse #21 Cloak Stage: The range penalty (G13.302) is reduced to +4.

**(G13.12) INDICATION, KNOWN DATA:** When the cloaking device is operating, the ship remains on the map, but an unused counter is placed on top, upside down, to mark it. Special "cloaked" markers are included in more advanced SFB products.

**NOTE:** This counter is used simply to mark that the unit is cloaked; it does not obscure the counter of the cloaked ship and does not conceal its identity or facing or the status of its turn or slip modes. See (D3.543) for shields. See (G13.61) for an optional alternative and (D17.51) if using tactical intelligence.

**(G13.13) FIRE CONTROL:** While the device is active, the ship cannot have its fire control systems in the active mode. See (G13.51).

**(G13.131)** At the instant that the cloaking device is activated (and fade-out begins), the fire control is turned to the inactive mode (D6.614). Fire control is also deactivated if a fade-in is reversed (G13.115).

**(G13.132)** When the cloaking device is turned off (and the fade-in begins), the owning player may, but is not required to, reactivate the fire control (D6.633). Because it takes fire control four impulses to become active, this can be accomplished before fade-in is complete, but the ship remains under the restrictions of (G13.51) until the fade-in period is completed. If activation is delayed or not started, the ship will not have fire control active when fade-in is complete. Until fire control becomes active (AND fade-in is complete), the ship cannot fire weapons or use any system that requires a lock-on. [In Advanced Missions the ship could fire by passive fire control (D19.0) after fade-in is complete and before fire control is active.]

**(G13.133)** Because the fire control is not active while cloaked or fading, the cloaked (or fading) ship will have no lock-ons. It cannot fire weapons (even by passive fire control). It cannot use tractors [except under (G13.432)], transporters [exception; (G13.421)], or any other system that requires a lock-on (D6.62).

**(G13.14) ACTIVATING THE CLOAKING DEVICE:** If the device is not operating, the owning player may announce that it has been turned on during the Cloaking Device Stage of the Sequence of Play. However, the device does not become fully active [i.e., gain all of the benefits of (G13.30)] until five impulses after the announcement. Further, from the time that the announcement is made, the ship is under the restrictions of (G13.5).

**EXAMPLE:** The ship announces on Impulse #20 that it is activating its cloaking device. The ship is under many of the restrictions of the device immediately, but does not gain all of the benefits until the Cloaking Device Stage of Impulse #25.

During the five-impulse period when the device is being turned on, the ship "fades" out of the tracking scopes of other ships. This is reflected by increasing the effective range from any firing ship to the cloaking ship by one hex for each of those impulses. Note that when the device is fully active (G13.31), the effective range is increased by five hexes (G13.302). This five-hex penalty is phased in over the five impulses of the fade-out period. Thus, in the example above, a ship three hexes from the cloaking ship would fire at the following ranges on the impulse indicated:

IMPULSE	19	20	21	22	23	24	25
DEVICE STATUS	OFF	<-----FADE----->					ON
PENALTY (G13.302)	+0	+1	+2	+3	+4	+5	x2+5
EFFECTV RANGE	3	4	5	6	7	8	11

Note that the sudden increase on Impulse #25 represents the doubling of the true three-hex range [under the terms of (G13.31)] when the cloaking device becomes effective. If lock-on had not been lost (G13.331), the range would not have been doubled.

**NOTE:** X-Ships (X0.0) have a different fade schedule.

**(G13.15) DEACTIVATING THE CLOAKING DEVICE:** If the device is operating, the owning player may announce that it has been turned off during the Cloak Stage of the Impulse Activity Segment of any impulse. At that point, the device is off and the ship may be locked-on to by enemy ships, losing the (G13.301) benefit. However, the ship itself may not lock-on to any enemy ship or fire/launch any weapons until its fire control becomes active AND fade-in is complete. Alternatively, it could use passive fire control (D19.0) AFTER fade-in is complete.

**EXAMPLE:** The ship dropped its cloak on Impulse #10; it could not fire/launch weapons until Impulse #15.

During the five-impulse period when the device is being turned off, the ship "fades" onto the tracking scopes of other ships. This is reflected by decreasing the effective range penalty (G13.302) from any firing ship to the uncloaking ship by one hex for each of those impulses. This five-hex penalty is phased out over the five impulses of the fade-in period. Thus, in the example above, a ship three hexes from the cloaking ship would fire at the following ranges on the impulse indicated:

IMPULSE	9	10	11	12	13	14	15
DEVICE STATUS	ON	<-----FADE----->					OFF
PENALTY (G13.302)	x2+5	+5	+4	+3	+2	+1	+0
EFFECTIVE RANGE	11	8	7	6	5	4	3

The drop over the first impulse represents the loss of the "double range" effect of the cloaking device given in (G13.301).

**NOTE:** X-Ships (XG13.0) have a different fade schedule.

**(G13.16) DESTRUCTION OF CLOAKING DEVICE:** The cloaking device is not on the SSD and cannot be destroyed in combat.

**(G13.161)** A cloaking device could be destroyed, but not captured, by a hit and run raid (D7.85). Guards can be assigned. (A box marked "Cloak H&R" appears on the SSD to record such destruction.) If an active cloaking device is destroyed, the ship begins fade-in (G13.118) immediately. For purposes of (D16.54), the cloaking device is in the same area as the bridge.

**(G13.162)** If the ship is in danger of being captured [i.e., has enemy marines on board or is crippled (S2.4) and held in an enemy tractor beam], the owner can try to destroy the device during the Cloak Stage of any impulse (but only once in 32 consecutive impulses). The chances of doing so are the same as those of destroying his ship (D7.7). This can be done even if the device is operating. If the device is destroyed, the ship begins fade-in immediately. The modifiers in (D7.7) apply. A Legendary Officer can only affect one of these. The "attempt to block self-destruction" procedure does not apply to the cloaking device.

**(G13.163)** If the device is not operating and enemy marines are not on board, destruction can be attempted once in the Initial Activity Phase of each turn, with a 1-4 chance of success (1-5 if a legendary captain or engineer makes the attempt). If the device is operating, it can only be destroyed as per (G13.162).

**(G13.164)** A destroyed cloaking device can be repaired by (D9.45).

**(G13.17) PLANETS:** A planet cannot be cloaked.

**(G13.18) DOCKING:** All units docked inside or to a larger unit (e.g., ships docked inside a base or fighters in a ship's hangar) are considered to be cloaked if the larger unit is cloaked. The smaller units do not pay a cloaking cost in this case. These smaller units could cause the cloaking device to be voided by performing any of the actions listed in (G13.4). Note that the tractor beams used to hold a ship in a docked position do not void a cloaking device. See (C13.9494) and (G13.431).

**(G13.2) ENERGY COST OF OPERATION**

The ships that have the cloaking device and the cost for using the device are shown in (G13.21).

**(G13.21) ENERGY COST OF OPERATION:** Energy must be paid to activate a cloaking device. This is usually paid during Energy Allocation, but may be paid with reserve power (H7.2) or contingent reserve (H7.6). If the full energy cost is not provided, the device cannot be activated. The cost per turn is as follows:

Base Station.....	8	Romulan K5R.....	6
Battlestation.....	12	Romulan KR.....	20
Starbase.....	40	Romulan War Eagle.....	6
Orion CR.....	10	Romulan Warbird.....	1

The above chart includes all ships in Basic Set. All ships have their cloak energy cost on their SSD. Also see Annex #7H in Advanced Missions for an expanded list of units.

**(G13.22) WARP SHUTDOWN:** If a ship shuts down (does not use for power) or has dropped (G12.6) its warp engines, it can cloak for a lower cost based on its size class. Size classes and reduced costs are listed below.

Size Class 1.....	30	Size Class 3.....	4
Size Class 2.....	6	Size Class 4.....	2

This "shut down" is accomplished during Energy Allocation by simply not allocating any energy from the engines. It is not the same thing as (D18.0) or (G30.0).

**(G13.23) ENERGY COST:** The cost of operating the cloaking device is paid once per turn, regardless of whether the device is operating 1 impulse, 32 impulses, or some number in between, and regardless of whether or not the device was activated, deactivated, or both (in either order) during that turn. If the device is not active during part (or all) of the turn, the ship does not recover any of the unused energy.

**(G13.231)** Energy paid to operate a cloaking device does not produce ECM, negative tractor, or any other effect for the cloaked ship.

**(G13.232)** A ship cannot pay the cost twice (or more) in order to avoid the restrictions of (G13.113).

**(G13.3) COMBAT AGAINST CLOAKED SHIPS**

Ships operating cloaking devices are more difficult to hit with weapons. Specific penalties are imposed.

**(G13.30) PENALTIES:** When firing at a cloaked ship, there are three basic penalties, as described herein. Under certain circumstances, some of these penalties may not apply.

**(G13.301) NO LOCK-ON:** The most basic effect of the cloaking device is that enemy units cannot lock onto the cloaked ship. This imposes a number of restrictions, e.g., (D6.12) and (D6.13), and causes the range to the cloaked ship to be doubled (D6.123). This penalty does not apply during the fade period (G13.14) or (G13.15). A lock-on can be gained to a cloaked ship by various means, as seen in (G13.333), (G7.99), and (G13.4). If a lock-on is achieved (and maintained), this penalty does not apply.

**(G13.302) RANGE PENALTY:** When firing at a cloaked ship, five is added to the range when calculating the effective range. This is done after the effects of (G13.301) are accounted for. During the fade period (G13.14) and (G13.15), this penalty is phased in (or out) gradually. This penalty is ignored if the firing unit has a tractor link to the cloaked ship (G7.993). The effective range (after both penalties) is used for tactical intelligence (D17.221).

**(G13.303) DAMAGE ADJUSTMENT:** All weapons (direct or seeking) fired at a cloaked ship are adjusted (probably downward) by (G13.37). Cloaking is a type of EW effect, but uses a different system. EW penalties for firing at a cloaked ship (D6.35) and (D6.36) are ignored; the chart in (G13.37) effectively IS the EW shift. This penalty does not apply to non-weapons (tractors, SFGs, transporters, etc.) There is no EW die roll as per (D6.37). Type-VI dogfight drones ARE affected. Exception: (G13.344).

**(G13.31) COMBAT WITHOUT A LOCK-ON:** If the enemy unit has no lock-on, all of the penalties in (G13.30) apply. Specific cases include:

**(G13.311)** Seeking weapons cannot function without a lock-on (D6.13) and are removed from play. Seeking shuttles go inert (FD1.72).

**(G13.312)** Direct-fire weapons are penalized because of the poor fire-control solution available. This is reflected by the penalties in (G13.30). See (G13.34) for additional conditions.

**(G13.32) COMBAT WITH A LOCK-ON:** If the enemy unit maintains a lock-on to a cloaked ship, penalty (G13.301) does not apply. Penalty (G13.302) still applies unless a tractor link exists to the cloaked ship (G7.993). Penalty (G13.303) still applies in any case.

Seeking weapons can be fired if a lock-on is retained and can be guided for as long as it is retained, but are (like direct-fire weapons) adjusted by (G13.37).

See (G13.34) and (G13.35) for additional conditions. If using hidden cloaking, see (G13.403).

**(G13.33) RETAINING A LOCK-ON:** If a firing unit had a lock-on to the cloaked ship before the cloaking device was activated, or if the



firing unit is able to achieve a lock-on while the cloaking device is operating through (G13.333) or (G13.4) or other causes, there is a possibility that the lock-on can be retained. Note that, if a ship enters a scenario cloaked, it cannot be locked onto except through (G13.333) or (G13.4) unless it uncloaks; see (G13.63).

**(G13.331) PROCEDURE:** The attempt to retain lock-on is made after fade-out is completed. The die is rolled in the Lock-On Stage of the Impulse Activity Segment of any impulse.

Attempts to retain a lock-on are also required if a lock-on is regained by any of the various means provided.

This probability is determined with the following formula:

$$P = S - (EW \text{ adjustment}) - RF + SF - 4$$

The terms of the equation are defined as follows:

- P = Probability of retaining lock-on
- S = Sensor rating of ship trying to lock-on
- EW = Electronic warfare adjustment
- RF = Range adjustment factor as shown below
- SF = Speed adjustment factor as shown below

The player controlling the firing ship rolls a single die. If the resulting number is equal to or less than the probability number determined by the equation, the lock-on has been retained.

**EW Adjustment:** Use the electronic warfare procedure (D6.34-Step #3) to calculate the differential, but if the result is negative, determine the result on the chart (D6.34) and apply it to the equation as a negative number.

Range Adjustment Factor	
True range	RF
0	-1
1 - 4	0
5 - 10	1
11 - 15	2
16 - 20	3
21 - 30	4
31 - 40	5
41+	6

Speed Adjustment Factor	
Maneuver Rate	SF
0	-2
1 - 4	0
5 - 8	1
9 - 12	2
13 - 15	3
16 - 17	4
18	5
19+	6

See (C2.42) for definition of maneuver rate.

**(G13.332) NEW DIE ROLLS:** A new die roll to retain the lock-on (i.e., another chance for the hunting unit to lose lock-on) is made whenever conditions (as defined by the equation) have changed in favor of the cloaked ship.

**(G13.3321)** The die roll is made in the Cloaking Device Stage of the Impulse Activity Segment of any impulse when conditions to maintain a lock-on worsen, or conditions to gain a lock-on improve. This is the ONLY point in the Impulse Activity Segment where die rolls to gain (G13.333) or retain (G13.331) are made, regardless of anything else that happens during the turn. Whenever a lock-on is gained, it is retained (at least) until the next Cloaking Device Stage. Note that EW is adjusted ONLY in the Fire Decision Step (D6.315) and hence would not affect these die rolls until the next impulse.

**(G13.3322)** If a lock-on has been retained, a new die roll is not made if conditions (the modifiers to the equation) show an improved chance of retaining the lock-on. For example, if the cloaked ship dropped its ECM, the equation would actually improve in favor of the other ship, and no new die roll would be required. A new roll is not required at the start of each turn unless the net effect of the equation has changed.

**(G13.3323)** A new roll is made only if the result of the equation changes, not if minor elements change. For example, a change from two to three net ECM points would not change the net ECM shift and, as such, would not cause a new die roll. If two factors change and the changes exactly offset each other, no new die roll is made.

**EXAMPLE:** A cloaked Romulan ship is desperately trying to shake a Gorn CA's lock-on. The Gorn has 3 ECCM points and the Romulan has 2 ECM points, for a net shift of -1 in the Gorn's favor.

The Romulan ship uses 1 point of reserve power (on Impulse #19) to raise his ECM to 3, producing a net shift of 0, altering the result of the equation (other factors remain constant in this example) and gaining a new die roll, which the Gorn wins.

The Romulan ship then (Impulse #20) uses another point of battery power to increase his ECM to 4, gaining a +1 shift in his favor and another die roll, which the Gorn also wins.

The Romulan ship, frustrated and desperate, has only 1 point of reserve power left. Using it for ECM will not change the net EW shift. Using rule (D6.316), the Romulan player drops 1 point of his ECM on Impulse #21, resulting in a +0 shift. As this changed in the Gorn's favor, no new die roll was needed.

The Romulan player then (Impulse #22) used his last point of reserve power for ECM, creating another "improvement" to a +1 shift and another die roll. (This is known as the ECM Yo-Yo, a tactic invented by Jeff Smith, who used it to win the SFB National Championships in 1983.) In this case, however, the Gorn *still* wins the die roll and retains lock-on.

Out of options, the Romulan ship then uses emergency deceleration to reduce his speed to zero, gaining a -2 speed factor and a new die roll at such favorable odds that the Gorn cruiser, at long last in position to fire his torpedoes, loses lock-on (and his demeanor). The Gorn ship then proceeds to set a T-bomb next to the Romulan ship and detonate it with one of his own shuttles to produce the "flash cube" effect of (G13.552). He gains a lock-on but, due to the ECM state and the low Romulan speed, fails the die roll to retain it. He repeats the process on the next impulse and can continue to do so as long as he has T-bombs, a means to place them, and a means to detonate them.

**(G13.333) REACQUISITION OF LOCK-ON:** After a lock-on (to a cloaked ship) has been lost (or if you never had one), the uncloaked ship may make an attempt to re-acquire (or acquire) the lock-on at the start of each turn (in the Lock-On Phase), and any point in the turn when the conditions as defined under (G13.331) improve.

The attempt is resolved by this equation:

$$P = S - (EW) - RF + SF - 10$$

Note that this equation is similar to that in (G13.331), but the numerical factor is increased. As a practical matter, a lock-on could only be re-acquired by a scout-supported ship that was close to a cloaked ship moving at relatively high speed.

This procedure is also used to acquire a lock-on to a ship that enters the scenario cloaked.

**(G13.334) SELF-GUIDING SEEKING WEAPONS** have special rules when targeted on cloaked ships.

**(G13.3341)** If self-guiding seeking weapons (SGSW, i.e., plasma torpedoes and ATG drones) are controlled by another unit, they do not make their own attempt but have a lock-on automatically if the guiding unit does.

**(G13.3342)** If the guiding unit tries and fails, the SGSWs are released (F3.4) and can immediately make their own attempt to retain the lock-on.

**(G13.3343)** If the SGSWs are not controlled by a unit, they make their own attempt to retain a lock-on; they have no outside ECCM but may have built-in ECCM (D6.393).

**(G13.3344)** Self-guided seeking weapons have a sensor rating of 6; see (F3.424).

**(G13.3345)** Type-VI drones which have a lock-on (FD5.131) do not lose that lock-on merely because the target cloaks.

**(G13.34) DIRECT-FIRE WEAPONS:** For all direct-fire weapons, use the effective range (D1.4) to determine the probability of a hit. [This effective range will be adjusted by (G13.30) to account for the circumstances.] In all cases, the adjustment chart (G13.37) is used to adjust the effectiveness of the fire. If the range (as adjusted for the cloak) exceeds the maximum range of the weapon, it should be painfully obvious to just about everyone that the weapon isn't going to do any damage.

**(G13.341) GENERAL:** For phasers, fusion beams, and tractor-repulsor beams, use the effective range to determine the damage caused by the weapon.

For disruptors, plasma bolts, hellbores, plasmatic pulsar devices, armed probes, and photon torpedoes, use the true range to determine the damage caused by a hit.

ADDs cannot be fired at cloaked units [except from inside the shuttle bay (G7.814)]. Maulers use (G13.344).

UIMs cannot be used unless the UIM can function at both the true and effective range.

**(G13.342) MINIMUM RANGE:** Note that weapons with a specified minimum range (e.g., non-overloaded photon torpedoes, PPDs, non-overloaded disruptors, etc.) cannot be fired if the true range is less than the stated minimum, even if the effective range is greater than the stated minimum.

**(G13.343) OVERLOADS:** Overloaded direct-fire weapons may be fired at a cloaked ship. See (D6.126). Feedback damage from overloaded weapons (if any) is not reduced by (G13.37).

**(G13.344) MAULER:** The range of a mauler is not adjusted for the effective range, but uses the true range only. Maulers cannot fire at a cloaked ship unless they have a lock-on. When firing with a lock-on, the adjustment in (G13.37) is not used. Instead, roll one die. A result of 1-3 indicates full effect (at true range); a result of 4-6 indicates a complete miss. This die roll is adjusted (up or down) by the ECM shift.

**(G13.35) SEEKING WEAPONS:** If a seeking weapon enters the hex occupied by the cloaked target ship, there is a substantial probability that it will not be able to find the target. Use (G13.37) to determine the damage caused.

**(G13.36) FADE PERIOD:** During the fade period (i.e., the effective range is no longer doubled but some adjustment is added to the range), the player controlling the fading (target) ship can use either of the following procedures at his choice. This choice is made (and announced) when fade begins. Whichever he selects must be used for all firing units during the entire fade period.

**(G13.361)** Use the chart in (G13.37), but add the penalty hexes to the die roll and then subtract five from the die roll. Ignore any EW effects.

**(G13.362)** Ignore (G13.37) and use the normal EW shifts.

**(G13.37) FIRE ADJUSTMENT CHART**

Roll one die to determine the actual result of each individual weapon. Note that in the case of a narrow salvo (E1.6), a single die roll is used for the entire volley. Direct fire weapons are affected by (G13.34); seeking weapons by (G13.35). Type-VI drones ARE affected. For additional data, see (G13.303) for penalty conditions, (G13.344) for maulers, and (G13.34) for seeking weapons. This table does not adjust the damage caused by explosions, including collateral damage (J3.3).

DIE	RESULT
1 or 2	Weapon does normal damage.
3 or 4	Weapon does 1/2 damage.
5 or 6	Weapon does 1/4 damage.
7 or more	Weapon does no damage.

**(G13.371)** A result of less than 1 is considered to be 1. [A shift could be caused by (G13.62).] Round fractions of 0.5 and more up, of 0.499 and less down. See (G22.73). A positive modifier can result from the effects of (G13.361) when combined with (G13.62).

**(G13.372)** This table is used in place of, NOT in addition to, the effects of any ECM shift. Cloaking is a very gross effect which effectively destroys the basis on which the ECM shifts are calculated. The cloak is the maximum possible effect. ECM helps ensure that the cloak will work (G13.331), but cannot increase its effect.

**(G13.373)** Apply the percentage to each weapon individually, not to the sum of each weapon type.

**(G13.4) LOSING CLOAKING DEVICE EFFECTS**

There are several ways in which a cloaked ship could lose some of the benefits of being cloaked. Many are listed in this section. This is known as "voiding" a cloaking device; the effect is to allow a lock-on and cancel the (G13.301) penalty. There are other means of voiding a cloaking device than those listed here. See ESGs (G23.62) and (G13.57), and also mines (G13.55).

Having a cloak voided is the worst thing that can happen as the cloaked ship loses the (G13.301) benefit and retains the penalties. If the ship voids its cloaking device by any of the procedures noted, it is still under the restrictions of (G13.4), (G13.5), and other relevant rules until the device is deactivated and fade-in is complete. Specifically, it cannot fire weapons until the device is deactivated and fade-in is complete. If the device is voided during the fade period, that fading process continues normally.

**(G13.40) EFFECT OF VOIDED CLOAK:** The primary effect of a voided cloak is that other units can gain a lock-on. This cancels the double-range penalty in (G13.301) and allows units to operate under the terms of (G13.32).

**(G13.401)** If the cloak is voided, other ships can gain a lock-on to it (except as noted). These enemy ships must roll to retain the lock-on. The die roll is in the (6B3) Lock On Stage (G13.331). See the detailed example under (G13.3323) for the precise sequence of events. Even if a lock-on is gained and retained, the five-hex penalty (G13.302) and the (G13.37) adjustment is retained. If a lock-on existed before the cloak was voided, a new die roll to retain it is not required.

**NOTE:** In this rule, and elsewhere in the cloaking rules, the term "may be locked onto" is used. The "may be" element reflects the die roll (D6.11) that all units must make to lock onto anything. If the unit's sensor rating is six, this is, of course, automatic.

**(G13.402)** In many cases, enemy ships will have several chances to gain and retain a lock-on. In such cases, the ship could roll for continued lock-on under (G13.331) during each of these impulses. If a unit has a lock-on, it is not required to roll again to *retain* a lock-on solely because of a subsequent opportunity to *gain* one.

**(G13.403)** If using hidden cloaking (G13.61), the position, identity, facing, turn mode status, and sideslip status of the ship is revealed if any ship gains a lock-on to the cloaked ship. This may be subject to (D17.51) if tactical intelligence *and* hidden cloaking are used.

**(G13.41) SHUTTLES, PFs:** A cloaked ship cannot pick up shuttles or PFs without being detected. The ship has to broadcast a homing signal for the shuttles and PFs (verbally announced by the player), and this signal could be detected and used for targeting. Shuttles cannot crash aboard a cloaked unit, even if they have a lock-on. The player owning the cloaked unit must voluntarily provide a homing signal to the specific unit attempting to land aboard by any means in order for a landing to be possible. Enemy boarding parties on the cloaked unit cannot provide such a signal. A cloaked ship can be locked-on to during the impulse in which it picks up a shuttle and during the impulse before and after the impulse in which the pick up is made.

A cloaked ship may launch shuttles and PFs. While this would give away its location (G13.61), enemy ships still could not "lock-on" to the cloaked ship. Also see (G27.3). See (G13.5) for laying a mine from a cloaked unit.

**(G13.42) TRANSPORTERS:** A cloaked ship exposes its position (and can be locked onto) during any impulse that it uses transporters (G8.0) and during the impulse after it does. There are some exceptions in the case of docked units (C13.4).

**(G13.421)** Transporters can only be used to a friendly unit that is also operating a transporter to receive the beam. This does not require active fire control by the cloaked ship, but does require active fire control by the receiving ship (ergo, the receiving ship cannot be cloaked). The receiving ship does not need a lock-on to the cloaked ship, but each operation will require two transporters (one on each end).

**(G13.422)** A cloaked ship cannot be boarded by transporters unless it can be locked onto.

**(G13.43) TRACTOR BEAM:** A cloaked ship loses the (G13.302) range benefit (or the firing ship avoids the penalty, depending on your point of view) if it is held in a tractor beam (G7.99) in regard to that specific firing ship. A unit may fade in or out of cloak while held in a tractor beam, but will not gain the full benefits of the cloak while so held.

**(G13.431)** Tractors used to hold a ship in a docked position do not count for this purpose (C13.949). See (G13.46) for units docked inside other units and (K2.46) for a PF docked to its PFT.

**(G13.432)** Negative tractor does not void a cloaking device.

**(G13.433)** A cloaked ship held in a tractor by a friendly unit has its cloak voided and can be locked onto.

**(G13.44) ELECTRONIC WARFARE:** A cloaked ship is presumed to be using a powerful form of ECM and may expend additional energy for ECM.

**(G13.441)** A cloaked ship cannot use ECCM because its fire control is not active (D6.62), although it may expend power for ECCM which would become effective if the cloak was turned off during that turn.

**(G13.442)** EW cannot be loaned to a cloaked ship (even by a scout that retained a lock-on), except during the fade-in/fade-out period. See (G13.54). If the cloaked ship is a scout, see (G24.28) and/or (G13.515).

**(G13.443)** A cloaked ship can receive ECM from natural sources.

**(G13.45) WEB:** If a cloaked ship enters a web hex (G10.0), it is trapped by the web in the normal manner (G10.51). A cloaked ship in a web hex can be locked onto. The web must have a strength of at least 1; unformed free-standing webs and zero-strength webs do not expose cloaked ships. Webs laid by casters, snares, or web generators are identical in this regard (after free-standing webs have formed). See also (G10.77).

**(G13.46) DOCKING:** The docking of cloaked units is a complex affair. The tractor used for docking could void the cloak; see (G13.43). There are two basic cases.

**(C13.461)** If one ship is cloaked and the other is not, the cloaked ship must broadcast a homing beacon (G13.41) for docking to be completed. Once docked, see (C13.949).

**(C13.462)** If both ships are cloaked, both must broadcast a homing beacon (G13.41) for docking to be completed. Once docked, see (C13.949).

**NOTE:** Docking is covered in Advanced Missions. PFs (Module K) docking to their PFT are covered by (K2.46).

**(G13.47) MARINES:** Boarding parties on board a cloaked enemy ship cannot assist in detecting or locking onto it. (The PRC-2000 radios carried by Marines are strong enough to talk to friendly ships but not strong enough to transmit an accurate homing signal.) If using (G13.61), the boarding parties can broadcast the specific hex that the cloaked ship is in.

**(G13.48) TERRAIN:** A cloaked ship operates against all types of terrain exactly as an uncloaked ship, except that during any impulse when it takes terrain-induced damage, it may be locked onto. Exception: Heat zones and radiation zones do not create a lock-on condition.

**(G13.49) ATMOSPHERE** does not void the cloaking device. The slight disturbances of the atmosphere are more than offset by degraded sensors on the searching ships.

### **(G13.5) OTHER EFFECTS OF THE CLOAK**

Use of the cloaking device has certain other effects.

**(G13.51) BASIC RESTRICTION:** A cloaked ship has its fire control system in the inactive mode (D6.64) and cannot use passive fire control (D19.0). These restrictions apply while the cloaking device is operating and during all fade periods, even if fire control has been activated during a fade-in period. Note that the reference here to the fire control being considered inactive does not mean that a weasel would not be voided if the fire control was activated as the ship came out of cloak.

**(G13.511)** A cloaked ship cannot gain or retain a lock-on to any object. See (D6.62) for a list of things the ship cannot do because it has no lock-on.

**(G13.512)** A cloaked ship cannot launch seeking weapons (even those with ATG or on a ballistic course) or guide those already launched.

**(G13.513)** A cloaked ship cannot fire direct-fire weapons.

**(G13.514)** Tracking of seeking weapons will be lost (F2.63).

**(G13.515)** Scout functions (except G24.28) will not operate on a cloaked ship.

**(G13.516)** A cloaked ship gains no benefit from passive fire control (D19.312).

**(G13.517)** Cloaked ships cannot determine the shield status of other units (D3.543). See (D17.222) when a cloaked ship is trying to use tactical intelligence.

**(G13.52) EXPLOSIONS:** Ignore the cloaking device when calculating the range for self-destruction and mine blast effects. Mines (G13.55) and ship explosions (D5.0) void the cloak on the impulse of the explosion for any cloaked ship within their blast range.

**(G13.53) MONSTERS:** All animal monsters ignore all effects of the cloaking device. Using their animal "sixth sense" and instincts, they can still detect a cloaked ship accurately enough for their weapons and other effects.

**(G13.54) WILD WEASELS:** A cloaked ship can launch a wild weasel. The WW distracts seeking weapons normally, but the ship cannot receive the ECM points provided by the WW even if the ship begins fade-in while the weasel is active.

**(G13.541)** A cloaked ship can launch a WW during fade-in/out and will receive the ECM points during the fade and uncloaked periods only. Once cloaking is completed, the ECM points will be lost even if the ship uncloaks later. Note that since the ECM of the weasel is lost once the fade-out is completed, this ECM will not be present for the calculations in (G13.33) to retain lock-on.

**(G13.542)** Launching a WW will expose the position of the ship if using (G13.61) but will not produce a lock-on.

**(G13.543)** A wild SWAC or PFS can be launched in the same manner.

**(G13.55) MINES:** A ship with a fully active cloaking device entering a hex within the detection radius of an explosive mine (or T-bomb) has a reduced chance of detonating the mine (since the mine's electronic "feelers" can't be touched by the ship).

**(G13.551)** In such cases, add three to the die roll, but an unadjusted die roll of "1" always means an explosion, regardless of modifiers. (This effect exists only after fade-out is complete and before fade-in begins.)

**(G13.552)** A cloaked ship is exposed and is locked onto during the impulse in which it is inside the area of a mine explosion. As with all units in such a blast area, a cloaked ship can be damaged by an explosive mine detonated by another unit. Note that the period of this lock-on lasts only until the next roll to retain lock-ons in the sequence of play. See the example in (G13.3323).

**(G13.553)** A cloaked ship cannot detect (M7.0) or sweep (M8.0) mines while the cloaking device is operating or until fade-in is complete or after fade-out begins.

**(G13.554)** Cloaked ships are not exposed by damage from weapons. See (G13.52).

**(G13.555)** A captor mine (M4.435) will not trigger against a cloaked ship since it cannot target it. A captor mine will gain a lock-on to a cloaked ship within its detection range if the cloak is voided (or dropped) and will then roll to retain that lock-on in the subsequent Lock-On Stage. A sensor mine will detect a cloaked ship (as any other mine would); it cannot order a captor mine to fire (unless that mine has a lock-on) but can order an explosive mine to detonate. See (M5.1121).

**(G13.556)** Mines may be laid from mine racks or dropped from shuttle bays by a cloaked unit without voiding the cloak. The mine will NOT become active until the cloaked unit has met the requirements of (M2.34), and this is based on true range, not effective range.

**(G13.56) LABS** on a cloaked ship may not gather any information while the cloaking device is operating or until fade-in is complete or after fade-out begins. Labs may not gather information about a cloaked ship. See (G4.43).

**(G13.57) ESGs:** An ESG ignores the effects of a cloaking device and damages cloaked ships normally (G23.621); the cloaked ship can be locked onto during the step when it suffers ESG damage.

A cloaked ship cannot operate an ESG; see (G23.622).

**(G13.58) DISPLACEMENT DEVICE:** A cloaked ship cannot be displaced even if the Andromedan ship has a lock-on to the cloaked ship; see (G18.72).

**(G13.59) ERRATIC MANEUVERS:** A cloaked ship cannot use erratic maneuvers (C10.24) while the device is operating. It can use EM during the fade-in/fade-out period, but must stop doing so before the fade-out is complete and before the die roll is made to retain a lock-on (G13.331).

**(G13.6) ADVANCED CLOAKING PROCEDURES**

**(G13.61) HIDDEN MOVEMENT (Optional-Experimental)**

This experimental rule can be used for extra excitement in hunting a cloaked ship. It is optional and requires the consent of all players. It will almost certainly require a non-playing moderator (or an extremely honest cloaked player). It is not intended to function as the sole or standard cloaking rule, but is only to be used for an interesting alternative. For purposes of play balance, the non-cloaking player should have a BPV advantage on the order of 33%, but this figure is not exact and is influenced by many factors such as terrain, weapons being used, experience of the players, and the size of the fleets.

**(G13.611)** The counter representing the cloaked ship is removed from the board, with the ship's position recorded secretly by the owning player. The movement of all ships should be recorded continuously, impulse by impulse and hex by hex, for later verification. Each cloaked ship is known and recorded as a unique individual, even if its location is not known. These are designated as Target #1, Target #2, etc. until a lock-on is achieved; see (G13.403).

**(G13.612)** Each opposing uncloaked ship may, twice per turn (on Impulses #8 and #24), require the owner of the cloaked ship to reveal which 60° firing arc (of that opposing ship) each cloaked ship is in and the true range. Only "ships" (which includes bases, interceptors, and PFs) can ask for the information. Shuttles (which includes fighters) and other units cannot. Probes (G5.0) can be fired into a hex within the limits of their rules and will count as an "observing ship" for the next observation impulse (#8 or #24).

**(G13.613)** If a lock-on has been retained, the player owning the cloaked ship must reveal, during the Activity Segment of each impulse, the data provided in (G13.403). This is done for each opposing ship which has a lock-on.

**(G13.614)** Seeking weapons (which have a lock-on) move on the board normally (F2.2). The owner of a seeking weapon moves it and the owner of the cloaked ship tells him if the hex entered is legally acceptable within (F2.2). If it is not, the weapon is returned to the original hex and the procedure is repeated. The seeking weapon could use an HET if necessary under the restrictions of (F2.13).

**(G13.615)** The counter is not removed from the board until fade-out is completed and lock-on is lost. The counter is returned when fade-in begins or when lock-on is regained.

**(G13.616)** It is possible that a T-bomb could be placed into the same hex as an unknown cloaked ship in violation of (M3.22). This is allowed (so long as the hex location of the cloaked ship is not known to that player/side).

**(G13.617)** When weapons are fired at or impact on a hidden cloaked ship, the judge makes any required die rolls secretly, determines the amount of damage (based on the range to the actual hex, and other factors), and announces this. Weapons fired at an out of arc target are announced as causing "no damage" after the judge makes a meaningless die roll.

**(G13.62) EXPERIENCE IN TRACKING (Optional)**

To account for the ability of enemy units to "learn" how to detect the cloaked ships (by adjusting their instruments and discovering just what to look for), the following procedure can be used. Add 10 (not 5) to the range (G13.302) on the first firing attempt, and reduce this penalty by one for each previous turn during which the firing unit (not player or side) fired at and scored damage points on the cloaked (not fading) ship with direct-fire weapons in this scenario. This penalty is adjusted specifically for each firing unit and each cloaked ship it is firing at. The penalty can never be reduced below three hexes.

Penalty	Impulse	9	10	11	12	13	14	15	
	Device	On	-----Fade-----						Off
3	Eff Rng	9	6	5	4	3	3	3	
4	Eff Rng	10	7	6	5	4	3	3	
5	Eff Rng	11	8	7	6	5	4	3	
6	Eff Rng	12	9	8	7	6	5	3	
7	Eff Rng	13	10	9	8	7	6	3	
8	Eff Rng	14	11	10	9	8	7	3	
9	Eff Rng	15	12	11	10	9	8	3	
10	Eff Rng	16	13	12	11	10	9	3	

Penalty	Impulse	20	21	22	23	24	25	26
	Device	Off	-----Fade-----					On
3	Eff Rng	3	3	3	4	5	6	9
4	Eff Rng	3	3	4	5	6	7	10
5	Eff Rng	3	4	5	6	7	8	11
6	Eff Rng	3	5	6	7	8	9	12
7	Eff Rng	3	6	7	8	9	10	13
8	Eff Rng	3	7	8	9	10	11	14
9	Eff Rng	3	8	9	10	11	12	15
10	Eff Rng	3	9	10	11	12	13	16

This rule is used with (G13.14) and (G13.15) by simply using the current rating (e.g., 10) in place of the standard 5-hex penalty. The fade-in/out will still take five impulses (so far as the cloaked ship is concerned); the penalty will increase/decrease one point per impulse, with its maximum rating just before lock-on is lost (or just after it is regained). The chart below assumes a ship at a true range of 3 hexes that turns the cloaking device off on Impulse #10 and back on during Impulse #21.

When deactivated the doubling effect is lost immediately; when activated the effective range increases as shown immediately.

**(G13.63) ENTERING A SCENARIO CLOAKED:** Some scenarios permit (or even require) a ship to enter the scenario while cloaked. The procedure in (D17.221) tactical intelligence is used [even if the remainder of (D17.0) is not].

While some scenarios may have other rules, one basic system is explained here. The scenario begins with the cloaked units at the specified range (e.g., 47 hexes from ships) and a speed of 4 (for the zero speed factor). The non-cloaked units are assumed to be at WS-1. See (G13.12) and/or (G13.403) for the data that would be available on the cloaked ship.

**(G14.0) TUGS AND PODS**

Tugs are capable of carrying various types of pods. When doing so, the combination operates under special rules.

Some races use pallets or cargo packs; these are in all respects functionally identical to pods except where and as noted.

**(G14.1) OPERATIONS**

**(G14.11) COMBINATION:** When a pod is attached to a tug, it becomes a part of that tug for ALL purposes.

**(G14.111)** The shields, sensors, scanners, damage control, and excess damage are all combined unless noted otherwise. When combining the sensor, scanner, and damage control ratings of the tug and pod, the undestroyable "residual" rating (zero for sensor or nine for scanner) is not added; if both have such a box, only one is used by the combined unit. Some pods contribute to the seeking weapon control rating (F3.2).

**(G14.112)** Power may be transferred freely between the ship and pod and in fact is not calculated separately. See (G14.353) independent operations, (G14.41) attachment procedure.

**(G14.113)** Any damage points scored may be distributed among the combined ship as the owning player sees fit. (Some tug+pod combinations, e.g., the Federation Battle Tug, have special rules on the distribution of damage noted on their SSD or in the ship descriptions.) Exception: (J1.413).

**(G14.114)** When determining the values of a tug+pod combination, simply add the BPVs, crew units, and boarding parties. However, if the specific combination is listed separately on the table (e.g., Fed Battle Tug, Klingon CVT), that listing, not the combined total, must be used. See the note at the end of the Master Ship Chart.

**(G14.115)** Pods can be used as part of a mobile base (R1.24). These pods are, within the limits of that rule, fully active and functional. They cannot be detached during a scenario.

**(G14.116)** No tug can have more than 6 PF mech links (including any on its pods).

**(G14.12) ENERGY COST OF SHIELDS:** The cost of raising the combined shields is the same as the cost of raising only the tug's shields.

**(G14.121)** Some battle tugs and carrier tugs are rated as a larger size class, costing more energy to raise their shields. These ships cannot raise only the tug shields (or only the pod shields), but must pay for the combined tug+pod shields.

**(G14.122)** The pod's shields can be left inactive to deceive an opponent, but take 1/4 turn to raise after intention to raise those shields is announced.

**(G14.13) INACTIVE PODS:** Pods, foreign pods (G14.72), Monitor pallets (R1.22E1), base augmentation modules, Skyhawk modules (one per SkH), and Sparrowhawk modules (two per SpH) can be carried by tugs. Two modules can replace each pod; if carried in pairs, they are linked together and cannot be dropped separately. The systems on the inactive pods are not operable and are treated as cargo boxes for damage purposes.

**(G14.14) MONITORS** (R1.22) carry special monitor pallets for extra combat capabilities. This is treated as a tug+pod arrangement.

### (G14.2) TUG MANEUVERABILITY

**(G14.21) CARRYING:** Carrying pods can increase the movement cost and turn mode of the tug. These changes are shown in Annex #3A. See also (G14.34).

**(G14.22) TOWING:** Pods can be towed by tractor (as most units can be). See Annex #7L for towing costs.

### (G14.3) RELEASING A POD

**(G14.31) RELEASE PROCEDURE:** A tug may release a pod during the Separations Stage of the Impulse Activity Segment of any impulse of any turn so long as the speed of the tug is 0 or 1 at the time of release; exception (G14.32). The pod counter is placed in the same hex and from that time operates independently (G14.35).

**(G14.32) RELEASE AT SPEED:** If released at a speed higher than one, score one point of internal damage to the pod *and* to the tug for each unit of the tug's effective speed (at the instant prior to release). See exception in (G14.33).

This is not cumulative with involuntary releases due to breakdown (C6.562). Damage is not scored for release at speed if the release is a result of (D21.44).

**(G14.33) DESTROYED POD:** If all boxes on the SSD of a pod are destroyed, the pod can be (but need not be) dropped immediately; it does not explode. This does not include sensor, scanner, damage control or excess damage boxes, but does include all internal boxes.

**(G14.331)** It can be released at any speed without damaging the tug; it cannot serve as a WW. If not released, the turn mode and speed of the tug remain under the 'with pod' conditions.

**(G14.332)** A pod with all boxes marked destroyed which is dropped is considered destroyed and cannot be repaired later.

**(G14.333)** A pod with all boxes marked destroyed which is not dropped counts as "crippled" for purposes of (S2.21) victory conditions (assuming that the tug survives the scenario). If the tug is captured, the pod is also considered captured.

**(G14.334)** This rule also applies to pods attached to bases.

**(G14.34) TUG MANEUVERABILITY:** At the instant that the pod is dropped, the movement cost of the tug will change (except in a few cases). This will cause the speed of the tug to increase immediately.

If the new speed is greater than the maximum speed allowed [30 movement points from warp power (C2.112)] or exceeds the acceleration limits (C2.411), the ship moves at the maximum speed allowed by those rules and the excess power is lost. Note that if the pod is dropped as a WW (J3.14) this sudden acceleration could cause the tug to exceed the voiding speed.

**EXAMPLE:** An LTT has 24 warp points but (with a pod) a movement cost of one. The ship has allocated all 24 warp points and 1 impulse point to movement, resulting in a speed of 25. During the turn it drops the pod, changing its movement cost to 2/3 and increasing its number of movement points to 37. The ship begins

moving at speed 31 (30 from warp), ignoring the other 6 movement points. The tug and the pod each take 24 points of damage due to (G14.32).

**(G14.35) INDEPENDENT STATUS:** If released from a tug, a pod operates on the board as a separate unit.

**(G14.351)** Some pods (e.g., cargo pods) have no engines, crew, shields, and/or sensor-scanner-damcon-exdam tracks. Such pods have an obviously limited capability to operate independently; a cargo pod would be little more than a target.

**(G14.352)** Some pods (e.g., Fed Starliner) have engines, shields, and weapons and are capable of operating as a starship (albeit a very slow and weak one).

**(G14.353)** At the instant a pod is detached, it begins to function as an independent ship to whatever extent it can for all purposes.

**(G14.3531)** If the pod has power, it must fill out an Energy Allocation Form immediately for the remainder of the turn, paying the cost of shields, life support, movement (no pod has warp engines, so one point of impulse will move the pod on Impulse #32 or provide a tactical maneuver), weapons, fire control, etc. If the pod was producing power used by systems on the tug, the tug will need to rebalance its energy by (D22.0).

**(G14.3532)** The various rules on how often a given system can be used still apply, e.g., a transporter on a pod that was used earlier in the turn (before release) still cannot be used again during that turn whether the pod is released or not.

**(G14.3533)** Fire control (for armed pods) becomes active at the instant of release if the tug+pod combination had active fire control prior to separation.

**(G14.36) WILD WEASEL:** A pod released from a tug can be used as a WW; see (J3.14).

### (G14.4) ATTACHING A POD

**(G14.41) PROCEDURE:** A tug may attach a pod during the Systems Function Stage of the Impulse Activity Segment, so long as the speed of the tug and pod at the time of attachment are both 0 and the tug or pod has at least one working tractor beam with power applied (and available for use within the rules). Both the tug and pod must have the same facing and be in the same hex. Note exception to facing in (G14.42).

**NOTE:** This actually uses that procedure in (C13.9), but since that rule is not in Basic Set, it has been summarized here. This also forms an exception to (C13.9), which allows docking only at the end of a turn, because tugs and pods are specifically designed to be docked (at any point in the turn).

**(G14.42) BACKWARDS PODS:** While an intriguing idea, analysis of the blueprints shows that pods cannot be mounted backwards on their tug. The power connections are not reversible, and the elevator shafts will align with the sewage system. There is one exception: Lyran cargo pallets can be carried backwards under their tugs; see (R11.N1).

**(G14.43) SIDE-BY-SIDE PODS:** Some tugs (in Advanced Missions) have two side-by-side pods; these are designated as side-by-side tugs in their descriptions. These tugs can operate with a single pod (on the centerline); a pod in this position blocks both normal positions.

**(G14.431)** A tug could not disengage by acceleration (C7.1) with one pod in a side position, and conversely could never arrive at a scenario with one pod in a side position, it could arrive with a single pod in the centerline position. This is the only penalty for carrying an off-center single pod.

**(G14.432)** For a side-by-side tug with one pod to pick up a second one, it would have to drop the first and then reattach both. If such a tug (with two pods) drops one pod, it will have to drop the other (possibly reattaching it on the center position) before disengaging by acceleration. Note that dropping that pod may damage the ship enough to prevent disengagement due to (G14.32).

**(G14.433)** The Gorn tug is treated as a side-by-side tug even though the pods are actually mounted above and below (or on) the hull axis.

**(G14.5) PROPORTIONAL CASUALTIES**

When detaching an undestroyed pod, any crew unit casualties previously scored can be distributed between the pod and tug at the owner's discretion, unless the separation occurred involuntarily (e.g., due to breakdown), in which case casualties must be distributed between the tug and pod in proportion to the original crews of each.

**(G14.6) PSEUDO-POD**

**(G14.61) DEFINITION:** This is not a true pod, but an imitation intended to deceive the opposing forces. The tug appears to be carrying a pod (of any type that the owning player cares to name), but actually is not. A pseudo-pod is an inflated light metal construct designed to appear as and give the electronic signature of a real pod. The purpose might be to convince a pirate or enemy fleet that an empty tug is really a battle tug or carrier tug or is carrying valuable cargo. In no case can an enemy determine that the pseudo-pod is not a real pod except by boarding it or scoring damage on it.

**(G14.611)** The player must designate before the scenario begins what type of pod the pseudo-pod is designed to look like.

**(G14.612)** Pseudo-pods cost 10 points.

**(G14.613)** Pseudo-pods take up 1 docking point (deflated and stored) or a number equal to the pod they are simulating.

**(G14.62) MANEUVER:** The pseudo-pod does not affect the movement cost or turn mode of the tug, although turning at the radius or speed assigned to an empty tug would expose the deception. A pseudo-pod will be destroyed automatically if the tug makes an HET. A pseudo-pod counts as a real pod for purposes of (G14.431).

**(G14.63) OPERATIONS:** A pseudo-pod can be towed by a ship, or detached to operate independently. It cannot move or take any action, but cannot be distinguished from a real pod. It will still appear as if it is real. It will appear to have the appropriate shields, although of course it does not and it would be destroyed by (G14.66). A pseudo-pod cannot be used as a WW.

**(G14.64) BOARDING PARTIES** transported onto a pseudo-pod are not harmed (they float inside the hollow shell) and report the deception; they will perish if the pseudo-pod is destroyed. They can be transported elsewhere at a later time. Hit and run raids would also reveal the deception. Pseudo-pods cannot be guarded. If a hit-and-run is executed against a pseudo-pod (not aborted by EW or general shield reinforcement) the BP will automatically return, no matter what is actually rolled for the hit and run raid, and report the deception.

**(G14.65) PSEUDO-TUGS:** While ships with similar hulls to a tug (e.g., Lyran Tiger vs Cougar, Lyran Jaguar vs LTT, Hydran Ranger vs Caravan, all LTTs to their CWs) cannot carry a pod because they lack the internal bracing, they could carry a pseudo-pod for deception purposes. This is extremely rare. No more than one ship per side could carry pseudo-pods. Pseudo-pods carried by non-tug units cost 25 points (due to the extra work to attach them).

**(G14.66) DESTRUCTION OF PSEUDO-PODS:** All pseudo-pods are destroyed by the first damage point allocated to one of the internal systems on the pod type they are simulating. Note that as the pseudo-pod has pseudo-shields, an independent pod would be destroyed by the first damage point of any type, while the shields of a tug carrying a pseudo-pod would be penetrated much earlier than expected (exposing the deception, even though no damage was allocated to the pod).

**(G14.7) CAMPAIGN NOTES**

**(G14.71) STRATEGIC MOBILITY:** For purposes of strategic mobility, it could generally be assumed that any tug could carry any pod, with the exception of the uniquely-shaped Lyran pallets and the small cargo packs carried by the Tholian CPC and Romulan FE. However, this is for cargo purposes only; due to incompatible power connections and dynamic balance, no systems on a towed foreign pod could operate and all boxes would be treated as cargo. The pod could NOT be dropped to assume independent operations as the systems would be shut down for safety purposes on the trip.

**(G14.72) FOREIGN PODS:** A carried foreign pod could be dropped, but would not be active (G14.13). It could be reattached, but would not become active (even on a ship of the same race) until taken to a base for servicing (between scenarios). It cannot be used as a WW.

Exceptions: Tholian CPCs and LTTs can carry Fed cargo pods. Lyrans use modified Klingon pods and can (rarely) use unmodified Klingon pods. Klingons can use Klingon pods modified to Lyran or Romulan service. Any tug can carry a civilian cargo pod (R1.34).

**(G14.73) STRATEGIC FREIGHTER DEPLOYMENT:** Freighters (and variants, including naval auxiliaries) can be carried "as cargo" by tugs. While rarely done, this might be used to deliver the slow-moving ships to their operational theaters.

**(G14.731)** The freighter could be activated in an emergency by using (G30.3). The tug would use its own repair systems for activation. Repairs to activate a freighter (D9.7) would not count against the tug's limit. The freighter's warp engines cannot be activated or active if the freighter is attached to a tug moving at a speed of 1 or more.

**(G14.732)** When allocating damage to freighters carried as cargo, all systems may be damaged, including Sensor, Scanner, etc. Freighters are not destroyed until they take an "excess damage" hit after all of their "excess damage" boxes have been hit (D4.40). Freighters may be dropped immediately (G14.33), even if "track" hits still remain.

**(G14.74) STRATEGIC GROUND BASE DEPLOYMENT:** Tugs (and LTTs) can deploy small ground bases. Two small ground bases are carried in place of one pod except as noted below. This applies to the tug's movement costs as well; two ground bases are equal to one pod weight. Medium ground bases are not substantially larger, they are interchangeable with small ground bases for strategic movement purposes. Ground bases are carried as inactive cargo, like freighters in (G14.73). They would normally be activated (G30.0) immediately prior to deployment. A tug's internal cargo cannot be used for bases. Races without tugs or LTTs cannot deploy ground bases.

**(G14.741)** ISC DPTs can carry one small ground base in place of their cargo pack.

**(G14.742)** Romulan SPHs carry one small ground base in place of each cargo module, not two. Romulan Freight Eagles can carry two small ground bases in place of their cargo pallet.

**(G14.743)** Lyran Tugs can carry two small ground bases in place of each pallet or pod.

**(G14.744)** Tholian CPCs and LTTs can carry two small ground bases, but cannot carry cargo packs while performing this mission.

**(G14.745)** Andros carry small ground bases as per (R10.3316).

**(G14.746)** A small freighter can carry two small/medium ground bases stowed as inactive (G30.0) cargo (a large freighter can carry four) replacing all its normal cargo capacity. When allocating damage to bases carried as inactive cargo, all systems may be damaged as cargo, including Sensor, Scanner, etc. A base that is more than half damaged by this process may not be deployed.

**(G15.0) ORION PIRATES  
SPECIAL RULES**

Because of their precarious political position, Orion ships are operated with a considerably different doctrine than ships of actual battle fleets. These benefits apply only to Orion-built warships that begin the scenario under Orion ownership. In a campaign, an overhaul at a base would be required to convert Orion-built ships in the hands of non-Orions, such as WYN ships or re-captured ships. These benefits can never be installed on or used by non-Orion ships or ships operated by non-Orions. There are some specific exceptions (e.g., the OK6) involving foreign-built ships in Orion hands that have some Orion benefits. These will be noted in their ship descriptions.

**(G15.1) NO SURRENDER**

**(G15.11) AVOID CAPTURE:** An Orion ship will never surrender (although it could be captured by boarding parties). When an Orion ship cannot disengage, the Orion ship will self-destruct rather than accept capture. Each Orion Captain will have to choose his own moment to self-destruct. This is ignored in Orion-vs-Orion battles.

**(G15.12) SUICIDE BOMB:** Orion ships have a nuclear suicide bomb. This is mentioned in (D5.2) and is included in the explosion strengths shown on the Master Ship Chart.

**(G15.2) DOUBLING ENGINE OUTPUT**

**(G15.20) BASIC RULE:** Orion ships (and only Orion ships) can double the energy output of their warp engines. This applies only to original construction Orion ships as in (R8.0) and does not include freighters operated by Orions. On each turn that this is done, one warp engine box is marked as destroyed. (There are some exceptions listed in the ship descriptions.) Note specifically the restrictions of (C2.112). If the ship has a cloak, see (G15.32).

**(G15.201)** To do this, the owning player simply increases the number on line 1 of his Energy Allocation Form to reflect which engines were doubled and circles it. This action (including which specific engines were doubled; e.g., left warp) must be announced in the Energy Allocation Phase; see Annex #2. Impulse engines (line 2 on the EAF) can also be doubled; see (G15.23).

**(G15.202)** The loss of one engine box occurs at the end of the turn in the Record-Keeping Phase.

**(G15.203)** The ship is not required to allocate all of the power produced from doubling the engines, but any unallocated power is lost. The ship cannot double its engines in mid-turn and declare the additional power to be "reserve" power; engine doubling can only be done during Energy Allocation.

**(G15.21) SHIPS:** All Orion ship types can double their engine output. However, each engine is doubled (or not doubled) individually.

**(G15.211)** The box destroyed by the doubling process is in addition to any combat damage. An engine box destroyed in combat during the turn cannot be used to satisfy this requirement. If the entire engine is destroyed during the turn, the penalty is meaningless and ignored.

**(G15.212)** Large Orion Ships (size class 3): Each ENGINE that doubles its output loses one box. Thus, a CR could lose two warp engine boxes per turn, a CA three [plus, perhaps, an impulse box in each case; see (G15.23)].

**(G15.213)** Small Orion Ships (size class 4): These ships lose only one engine box per turn, even if both warp engines and the impulse engine are doubled, but the engine box lost must be a warp engine box if either warp engine was doubled. The DBR is a special case. Its warp and impulse engines are doubled separately, each costing one destroyed box of the type doubled.

**(G15.214)** Repaired engine boxes can be doubled. See also (G15.29) for hastily repaired engines.

**(G15.22) ORION PFs:** Orion PFs (and interceptors, which use the PF rules) can double their warp engines and booster packs.

**(G15.221)** Orion PFs lose only one engine box per turn through this procedure, even if both warp engines and the impulse engine are doubled, but the engine lost must be a warp engine if either warp engine was doubled. Note that PFs must double all of their warp engines, and cannot double just one (G15.223).

**(G15.222)** The engines and booster packs on a PF are doubled separately. Doubling the packs destroys them but doubles the engines without damage. Doubling the engines without doubling the packs results in a loss of one engine box (no damage to the packs).

**(G15.223)** A PF must double all of its warp engines (and/or all of its warp packs); it cannot double individual engines or packs.

**(G15.23) IMPULSE ENGINES:** Orion ships can also double the output of their impulse engines.

**(G15.231)** For size-3 ships, one impulse engine box is marked off if any or all of the impulse engine boxes run at double output.

**(G15.232)** PFs (G15.22) and size-4 ships (G15.213) can double the impulse engines without damage if they double any of their warp engines at the same time. Exception: DBR (G15.213).

**(G15.24) DISENGAGEMENT:** Orion ships can use double output to disengage, but are not required to use it to calculate required power.

**(G15.25) EXPLOSION:** The doubling of engine output does not increase the power of an explosion (D5.0).

**(G15.26) SPEED LIMIT:** An Orion ship cannot generate more than 30 movement points with warp power (even using engine doubling), even to penetrate a web, tow another ship, or escape from a black hole; see (C2.112). spent for HETs or EM is not movement and not limited by the speed. The ship could move 31 and perform these maneuvers. See (C12.38).

**(G15.27) VICTORY CONDITIONS:** Engine boxes lost due to doubling count as damage for purposes of (S2.22).

**(G15.28) UNITS UNABLE TO DOUBLE:** Orions in captured ships cannot double the engines of those ships. Captured Orion ships cannot double their engine output. Orion bases cannot double their power output. Orion ships sold to other races (e.g., WYN) cannot double their engines. Some ships captured by the Orions and modified to use some Orion technology (e.g., OK6) are specifically defined in their ship descriptions.

**(G15.29) REACTORS:** APRs and AWRs cannot be doubled. Warp boxes hastily repaired (G17.5) as AWRs and impulse boxes hastily repaired as APRs can be doubled as part of that engine. Note that impulse boxes repaired as APRs, and Warp boxes repaired as AWRs can be given up as the box required to be destroyed as a result of engine doubling.

**(G15.3) CLOAKING DEVICES**

Virtually every type of equipment in known space (with the significant exceptions of Andromedan and Tholian equipment) has found its way into the hands of the pirates, and the cloaking device is no exception. Some Orion ships may have cloaking devices; their BPV is increased (R8.R4). The BPV increase is noted on each SSD.

**(G15.31) COST OF OPERATION:** The cost of operation is shown in (G13.21), Annex #7H (in Advanced Missions), and on each SSD.

**(G15.32) DOUBLE ENGINES:** If the warp engine output is doubled, the power required to operate the cloaking device is also doubled due to the brighter electronic signature that must be masked. If only one engine is doubled, the cost of cloaking is increased by 50% if the ship has two engines, 33% if it has three. Doubling impulse engines does not increase cloak costs.

**(G15.4) OPTIONAL WEAPONS MOUNTS**

**(G15.41) MOUNTS:** Many Orion (and WYN) ships have boxes on their SSDs that are marked "OPT." This indicates an optional weapons mount, which can include any ONE of the weapons listed in Annex #8B.

**(G15.411)** The BPV of the ship is adjusted by the stated amount in the case of each weapon.

**(G15.412)** See (R8.R3) for the firing (or launch) arcs of the weapons installed in option mounts.

**(G15.413)** Each plasma-torpedo launcher (other than a type-D plasma rack) comes with one PPT (FP6.0).

**(G15.414)** No Orion unit at any time under any circumstances can ever have or use a phaser-IV, plasma-R, mauler, any Andromedan-only technology (e.g., DisDev, TR, PA), or any Tholian-only technology (e.g., web generator, web caster, snare generator, ability to move or fire through webs).

**(G15.415)** Optional weapons cannot be changed without a shipyard overhaul taking several weeks or months. See (U7.27).

**(G15.42) AVAILABLE ITEMS:** The following items can be placed in an optional weapon mount:

Weapons listed in Annex #8B, batteries, APR, AWR, labs, cargo, tractor beams, probe launcher.

Additionally, those mounts in the main hull (not wings) of Orion ships can include transporters, repair, or hull. They could also include barracks, but the marines would have to be purchased separately.

Mounts in the main hull cannot include mech-tractors, but could include tractors.

None of the non-weapon options changes the BPV of the ship.

**NOTE:** See (U7.113) for additional technology restrictions.

**(G15.43) WING MOUNTS:** The wing mounts on all Orion ships are too weak to mount some weapons (see Annex #8B). All option mounts not on the centerline of the ship are considered to be "wing" mounts unless specifically designated otherwise in the ship description. The side mounts on the WYN Auxiliary ships are noted in the ship descriptions as not being restricted in this manner.

**(G15.44) AVAILABILITY:** Which weapons are available depends on which cartel (R8.1) the ship is operating under. The limits below apply to the entire Orion battle force, as otherwise no ship would have enough option mounts to have a 10% availability weapon.

**(G15.441)** At any given time, 70% of the option mounts on a given cartel's ships will use the weapons used by the race of the Home Territory, 20% by other races within the Operating Zone, and 10% will be any available weapons.

**(G15.442)** The Cluster Cartel is an exception (due to its protected shipyard). This Cartel treats Kzinti, Lyran, and Klingon space as "Home" territory (90% of weapons) and can select the other 10% from all other allowed weapons. The WYNs are under the same restrictions as the Cluster Cartel.

**(G15.443)** Unless otherwise noted in the rules, a single ship alone in a scenario would have one option mount from races of the Operating Zone and the rest of its option mounts filled with weapons from the Home Territory. The players may agree beforehand to allow a wider weapons selection as part of balancing a scenario.

**(G15.444)** The Standard Technology Chart in (U7.28) lists the technology known to each race. Known Foreign Technology is not considered in the case of Orion Option Mounts (e.g., the Dragon Cartel does not have "home" access to type-F plasma torpedoes).

**(G15.5) LABS**

Orion ships without labs can use one of their control spaces as a lab. See (G4.3) for the procedure.

**(G15.6) GRAVITY LANDING SYSTEM**

All Orion ships have a gravity landing system to land on planets and moons (unless noted otherwise in their descriptions); see (P2.432). Many are capable of other landing systems; Annex #7B. Check (R8.0) before assuming that a given ship can use this system.

**(G15.7) FIGHTER AVAILABILITY**

This rule determines the availability of fighters for the Orion carriers in situations not specified by scenarios. Free campaigns should use this procedure to avoid abuse by the Orion players.

**(G15.71) PROCEDURE:** The Orion player rolls two dice, and uses the result to access the chart below and determine what types of fighters are available. The Orion player always has the option to take fighters of a lower class than those provided by the die roll.

DIE ROLL	75%	25%
3 or less	Class I Local	Class I Cartel
4-6	Class I Cartel	Class II Local
7-9	Class II Local	Class II Cartel
10-12	Class II Cartel	Class III Local
13-15	Class III Local	Class III Cartel
16 or more	Class III Cartel	Any

Classes are by standard definitions (i.e., Fighter Classes as noted in Annex #4). Local means that the fighters must be of a type used by the race in whose territory the ship is operating. Cartel means that the fighters can be of types used by any races in which the cartel owning or licensing the ship operates. As a rule, 75% (6 on a CVL, 9 on a CVS) are of a more common type than the other 25% (2 on a CVL, 3 on a CVS). No more than 25% of the fighters (as above) can be armed with hellbores, disruptors, or Fed-gatlings.

Heavy fighters (J10.0) cannot be operated by the Orions.

Adjustments (which are cumulative) made to the die roll:

- Ship is a CVS or CV = +2
- Ship has a Poor Crew = -2
- Ship has an Outstanding Crew = +1
- Ship has a Legendary Captain = +1
- Ship has a Legendary Ace Pilot = +2

**(G15.72) MRS:** Availability of MRS shuttles is as follows:

- 1-3 Home area MRS types.
- 4-5 Operating area MRS types.
- 6 Any MRS except Tholian.

This assumes that the optional MRS rules (J8.0) are in use and that the Orion ship in question is eligible to carry one.

**(G15.73) SWAC:** Orions cannot operate SWAC shuttles (J9.0) even if they captured them. See (U7.125).

**(G15.8) STEALTH BONUS**

**(G15.81) BONUS:** Most Orion warships are designed with a narrow silhouette and with a sensor-absorbent coating to make them harder to hit. This is reflected as ECM points and is known as the "Orion Stealth Bonus." See (D6.394). Not all ships have the same bonus; the bonus for each ship is noted on its SSD.

**(G15.82) LOSING THE BONUS:** Orion ships lose the Stealth Bonus if they double their warp engines. The stealth bonus is lost for as long as any warp engine is doubled.

**SYNOPSIS OF G RULES IN OTHER PRODUCTS**

To aid in later integration of Basic Set with expansion products, the Basic Set rules have numerous cross-references to the rules from those other products. If you do not have a given product, then ignore any rules in it. To aid in understanding the Basic Set rules, the following synopsis of these rules is provided.

**(G16.0) STASIS FIELD GENERATORS:** A Klingon device which allows them to "stop time" in limited areas, freezing an enemy ship in place or protecting a friendly ship from harm. Advanced Missions.

**(G17.0) REPAIR SYSTEMS:** Used by starbases, fleet repair docks, and other units to repair damaged ships. Advanced Missions.

**(G18.0) DISPLACEMENT DEVICE:** An Andromedan system able to move ships through space. Module C2.

**(G19.0) SATELLITE SHIPS:** The operations of small ships carried inside larger Andromedan ships. Module C2.

**(G20.0) ENERGY MODULES:** An Andromedan system for getting surplus energy off of their ships. Module C2.

**(G21.0) CREW QUALITY:** An optional rule under which ships with particularly good crews receive benefits and bonuses while those with poor crews have limits and problems. Advanced Missions.

**(G22.0) LEGENDARY OFFICERS:** An optional rule providing a "role playing" aspect for SFB by creating certain characters who can provide bonuses in the use of certain systems. Advanced Missions.

**(G23.0) EXPANDING SPHERE GENERATOR:** A weapon used by the Lyrans to protect their ships from drones and fighters and to ram enemy ships. Module C1.

**(G24.0) SPECIAL SENSORS:** Advanced electronic warfare rules for scouts, allowing them to jam enemy sensors, attract or distract seeking weapons, and other things. Advanced Missions.

**(G25.0) COMBAT CARGO TRANSFER:** Rules for transferring cargo between ships in mid-scenario. Advanced Missions.

**(G26.0) WEB ANCHOR BUOYS:** A Tholian device able to provide an anchor point for web. Advanced Missions.

**(G27.0) CLOAKED DECOY:** A Romulan device to distract the enemy from tracking a cloaked ship. Advanced Missions.

**(G28.0) BARRACKS:** A special type of hull used on troop transports and commando ships. Advanced Missions.

**(G29.0) POSITIONAL STABILIZERS:** Used by bases to stabilize their position in space. These prevent bases from being towed by enemy tractor beams and allows them to have phaser-IVs. Advanced Missions. All of the bases in Basic Set have these.

**(G30.0) INACTIVE SYSTEMS:** A special scenario rule used for ships undergoing repair or incomplete. Advanced Missions.

**(G31.0) TEMPORAL ELEVATOR:** An Andromedan device for base defense. Module C3.

**(G32.0) PRIMETEAMS:** A special type of boarding party.

**END OF SECTION (G0.0) BASIC SET**



**(H0.0) POWER SYSTEMS****(H1.0) GENERAL RULES**

The operation of starships in this game is primarily based on electrical power. Ships (which include bases, warships, freighters, PFs, interceptors, etc.) generate power from their engines and reactors and expend power for movement, shields, weapons, and other activities. Batteries can be used to temporarily store surplus power and deliver it when needed.

The rules below describe the power-producing systems of the ships. Note that some systems (such as photon torpedoes) and some functions (such as movement faster than a speed of 1) require the expenditure of warp power.

Note rule (D4.223), which states that any system which is destroyed ceases to produce power at the end of the turn. Exceptions: (D22.0) Energy Balance due to Damage and (H7.38) destroyed batteries lose their power immediately.

The power which is generated by a system lasts only until the end of the turn for which it was generated, at which time it is lost if it was not used (excepting any power placed in batteries or other systems capable of storing power). The next turn each power system box (except for batteries, which must be refilled) could again generate power which may be applied. Note that reserve power (H7.0) is withdrawn from the batteries at the time of use (H7.13), and it will last until the end of the turn in which it is withdrawn.

The terms "energy" and "power" are generally used interchangeably in the rules to Star Fleet Battles.

The terms "energy point", "point of energy," "point of power," "unit of energy," and "energy unit" are also used interchangeably.

Fighters, shuttles, and seeking weapons technically do generate and expend power, but this is done automatically and does not require the detailed accounting used for ships.

**(H2.0) WARP ENGINES**

Warp engines are the primary power source of most of the ships in the game. They use the reaction between matter and anti-matter to produce tremendous amounts of energy. They are the only power source that can move the ship at translight speeds (more than one hex per turn).

**NOTE:** Shuttles (including fighters) use warp drives, but these are accounted for by special rules in section (J0.0). As these units do not allocate power (it is allocated for them by the rules), they do not concern us here.

**(H2.1) SSD**

Each box in the cluster of boxes on an SSD which is marked "warp engine" (or "warp" or "WRP", etc.) represents one unit of power. For example, the warp engines of the Federation heavy cruiser each have 15 boxes and can each produce 15 units of power. The Kzinti strike cruiser's three engines only produce 9 units of power each. The Gorn heavy cruiser's engines produce 16 units of power each.

The WYN radiation zone (P7.1) can reduce the power output of warp engines.

**(H2.2) REQUIRED USE**

Some activities REQUIRE that the specific energy used in that activity be warp energy. This is specified in the rules for all applicable systems. A partial list includes:

- high energy turns (C6.22),
- movement faster than one hex per turn (C2.111),
- warp tactical maneuvers (C5.22),
- arming or overloading photon torpedoes (E4.21),
- operating displacement devices (G18.2),
- arming a probe as a weapon (G5.32), and
- arming suicide shuttles (J2.221).

**(H2.3) WARP REACTORS**

Warp power can also be produced by warp reactors (H4.3). Power from warp reactors cannot be used for any movement-related function (e.g., movement, warp tactical maneuvers, high energy turns, erratic maneuvers, etc.) but can be used for other warp-required functions listed in (H2.2).

**(H2.4) UNRESTRICTED USE**

Warp power can always be used for any activity that does not specifically require some other form of energy [e.g., impulse movement (C2.111) and sublight tactical maneuvers (C5.12) specifically require impulse engine power]. While warp power is primarily used for movement, players are not required to use some, or any, of their warp power for this purpose. Warp power can be used for non-warp purposes, such as shields, transporters, weapons, etc.

**(H2.5) EMERGENCY WARP**

Some Klingon penal ships (R3.R5) have emergency warp engines. (These are in Module R3, so this provision can be ignored by the beginning player.) Power from these engines cannot be used for movement-related functions until ship separation occurs; also see (H3.5), (G12.11), (G12.71), and (R3.R53). It can be used for other functions at any time. This rule does not apply to other ships unless stated otherwise in the rules.

**(H3.0) IMPULSE ENGINES**

Impulse engines are nuclear/ion engines, not unknown in the late 20th Century. They can produce tremendous amounts of power, but cannot move the ship faster than the speed of light. Their power may be, and often is, used for other purposes.

**(H3.1) SSD**

Each box in the cluster (or clusters) of boxes on an SSD marked "Impulse" (or "IMP") represents one unit of power. For example, the Federation CA has four "Impulse" boxes and (hence) four units of impulse power.

**(H3.2) RESTRICTED USES**

Impulse power can be used for any function that does not require warp power. Players can but are not required to use some of it for movement.

**(H3.3) MOVEMENT**

If all impulse engines are destroyed, the ship can still move by warp power [it could not use sublight tactical maneuvers (C5.1) which require impulse power]. Remember that the equation for speed includes the number of warp engine boxes used for movement (adjusted for the ship's movement cost) plus (possibly) one movement point provided by one impulse engine (C2.16). If a given ship doesn't have impulse engines remaining, its speed is limited to 30 or by whatever warp power (adjusted by movement cost) it has (whichever is less).

**(H3.4) IMPULSE MOVEMENT COST**

Regardless of movement cost, one unit of impulse power will move a ship (or several ships tractorated together) one hex. See (C2.111). One point of impulse power could alternatively produce one sublight tactical maneuver (C5.1) if the ship was not moving.

Exception: Impulse power cannot move a large asteroid (P3.434).

Exception: Impulse power is sometimes not used in the case of ships linked by tractor beam. See (G7.36-B).

**(H3.5) EMERGENCY IMPULSE**

Some ships (e.g., Klingon D7) have emergency impulse engines. Power from these engines cannot be used for movement-related functions until ship separation occurs; see (G12.11). It can be used for other functions at any time. See also (G12.71) in the case of Klingon ships.

**(H4.0) AUXILIARY POWER REACTORS**

Most ships in the game are equipped with auxiliary power reactors (APRs). These are nuclear reactors of advanced design, with improved safety and environmental equipment.

**(H4.1) SSD**

Each APR box on an SSD represents one unit of power available from the auxiliary power reactors.

**(H4.2) RESTRICTED USE**

Reactor power can be used for any purpose not specifically requiring warp power or impulse power.

**(H4.3) WARP REACTORS**

Certain ships have AWR (Auxiliary Warp Reactors) instead of or in addition to the more common APRs. These include the general APR/AWR conversion applied to many Federation ships in their refits (R2.R3), some of the more modern ships built during the late General War years, and other rules (e.g., ship modifications) that may be presented in future products.

**(H4.31)** Warp power from AWRs cannot be used for movement-related functions (including EM, warp-TACs, or HETs).

**(H4.32)** AWRs are damaged on APR hits. Exception: the warp reactors on bases (except starbases) are considered to be "center warp engine" and not APR for damage purposes.

**(H5.0) BATTERIES**

These are conventional storage batteries, though of an incredibly advanced design. Batteries are the key element in Reserve Power (H7.0).

**(H5.1) SSD**

Each box on an SSD marked "battery" (or "BTTY" or "BTY") represents one battery.

Each battery has the capability to store up to one point of energy for later use. Exception: (H5.5).

See (H7.38) in the case of a battery which is destroyed while holding power.

**(H5.2) CHARGED STATUS**

All batteries of all ships are presumed to be fully charged at the beginning of all scenarios unless otherwise specified in the scenario rules.

Exceptions: Maulers (E8.0) might not have energy in their batteries if they have been surprised (D18.14). Andromedan ships see (D10.55).

**(H5.3) CAPACITY AND USE**

The power stored in batteries may be used when extra energy is needed; the batteries can be recharged during Energy Allocation.

The use of batteries in this respect is more fully covered in the Energy Allocation rules (B3.0).

**(H5.31)** No battery may hold more than one unit of energy; exceptions are listed in (H5.5). Batteries may hold fractional points of energy so long as the total is less than or equal to the capacity of the battery.

**(H5.32)** Batteries discharged during Energy Allocation may be recharged during the same Energy Allocation Phase, presumably to facilitate the use of Reserve Warp Power (H7.43) or Reserve Impulse Power (H7.47), although the procedure is not restricted to that one use.

**(H5.33)** Each battery is used independently of other batteries, even in the case of connected SSD boxes.

Exception: Many of the batteries on ships equipped with a mauler must be discharged in groups when fired through the mauler cannon (E8.32).

**(H5.4) LEGAL USE**

A battery cannot be discharged unless the energy is being used for something in the Energy Allocation Procedure (B3.0) or in mid-turn as Reserve Power under the provisions of (H7.0).

Note that, if a player wishes to discharge batteries, he can use some or all of his battery power instead of using the full amount of output from his power-producing systems.

Power from batteries is neither warp nor impulse power and, as such, cannot be used for functions which require those specific types of power. Exceptions: Reserve Warp (H7.4), Reserve Impulse (H7.47), Second-Generation X-batteries (XH5.1).

**(H5.5) SPECIAL BATTERIES**

Some units have special or improved batteries. These are listed here.

Andromedan ships (D10.55) have batteries which are able to hold 5 units of power each.

First Generation X-ships (XH5.1) have batteries able to hold 3 units of power each.

Second Generation X-ships (XH5.1) have batteries able to hold 5 units of power each. These batteries can hold "warp power" for multiple turns.

Note the Andromedan batteries are not "X-batteries" and cannot hold warp power as X-ship batteries can.

**(H5.6) TRANSFER**

Power can be transferred from one specific battery to another during Energy Allocation. This might be done by a mauler to reorganize its firing ability.

**(H6.0) PHASER CAPACITORS**

All ships have a "phaser capacitor." This is a special storage battery (actually a network of smaller capacitors) used to fire the ship's phasers. The terms "capacitor" and "capacitors" are both technically correct and may be used interchangeably when talking about the phaser capacitor on a ship.

Capacitors must be energized (E2.3) before they can hold power. Some other systems [example ESGs (G23.24)] also have capacitors; these are not linked to or part of the phaser capacitor.

**(H6.1) ENERGY HELD**

Energy can be held in the phaser capacitor from one turn to the next and can be withdrawn during any impulse to fire the ship's phasers. It can never be withdrawn for any other purpose; exception Energy Balance due to Damage (D22.15). See (H6.5).

**(H6.2) ENERGY USED**

Energy can be added to the phaser capacitor as allocated power during the Energy Allocation Phase (B3.0) or by using Reserve Power (H7.0) during the Impulse Procedure and Record-Keeping Phases.

**(H6.21) LIMIT:** Capacitors have an absolute limit as to how much power they can hold. The capacity of the phaser capacitor is equal to the total amount of power required to fire each of the ship's phasers one time, rounded to the next higher whole number. For example, the Federation CA, with 6 ph-1s, has a phaser capacitor of 6; the Kzinti CV, with 5 ph-1s and 11 ph-3s has a phaser capacitor of 11 ( $5 \times 1 + 11 \times 0.5 = 10.5$ , which is rounded up to 11).

Exception: When using the Advanced Rules (or higher), Fractional Accounting (B3.2) is used and the capacity of the capacitor is exactly equal to the energy required to fire the phasers (do not round up), in which case the Kzinti CV's capacitor would hold 10.5 points rather than 11.

**(H6.22) REQUIRED CAPACITOR:** All energy to fire phasers must come from the capacitors (not directly from power sources), and energy cannot be allocated to the capacitors unless they have the capacity to receive it. If the capacitors are still full from the previous turn, no power can be allocated to phasers. Reserve power used to fire a phaser is applied to the capacitor and can then immediately be used to fire the weapon in the same impulse (within the restrictions of the rules, e.g., rate of fire).

If the capacitors are full when reserve power is applied and phasers are fired, it is assumed that power was drawn from them and simultaneously replaced with the reserve power.

**(H6.23) ANY PHASER.** The energy from the phaser capacitor can be used to fire any phaser of the ship, within the restrictions of the rules. It is therefore possible, without applying additional energy to the capacitor, to draw energy from the capacitor during one turn in order to fire a particular phaser and then, on the next turn, to draw energy from the capacitor to fire the same phaser again (assuming sufficient energy remains in the capacitor). For example, a Klingon D7 has nine ph-2s and therefore its phaser capacitor can hold nine units of power. Since the most common Klingon attack (oblique approach) will result in firing only seven of the phasers, two points will remain in the capacitor at the end of the turn and could be used next turn to fire two of the phasers which fired on the first turn.

**(H6.3) DESTRUCTION**

If a phaser is destroyed, an equivalent portion of the phaser capacitor is also destroyed. Any energy in the destroyed portion is lost. Naturally, players may consider the uncharged (i.e., empty) elements to be destroyed first. If a phaser is repaired, an equivalent portion of the capacitor is also repaired (although it is uncharged). If all phasers have been destroyed, the entire capacitor is considered destroyed.

**(H6.4) TIME LIMIT**

Power can only be held in a capacitor for 25 turns. If the power is not used in that time, it is lost and cannot be recovered. The capacitor could, however, be recharged without penalty. See (E2.32) for more detail on this function.

**(H6.5) ENERGY BALANCE**

See (D22.15) for a possible way in which power could be taken from the capacitors.

**(H7.0) RESERVE POWER**

Ships may use their batteries as a source of reserve power. Note specifically that unallocated power from engines or reactors is NOT treated as reserve power; it was simply never produced (B3.4). Excess movement energy released by Emergency Deceleration (C8.102) is not treated as reserve power.

All ships may use reserve power during all historical periods unless noted otherwise in specific rules.

In general, any system may receive power at the appropriate time from the application of reserve power. This is subject to the restrictions of this entire section (H7.0) plus any additional restrictions stated in the rules of the particular system.

**(H7.1) OPERATIONS**

**(H7.11) TIMING:** A battery may be discharged to produce reserve power at any time during the impulse procedure at the option of the owning player. See (H7.13) for restrictions.

**(H7.111)** Batteries can be discharged during Energy Allocation to produce power that is allocated in that phase, but batteries which remain charged (or which were charged) during Energy Allocation are available for use as reserve power. By definition, reserve power is generated by the unplanned discharge of a battery; battery discharges allocated during Energy Allocation do not produce reserve power, although they may help to clear the batteries for the subsequent use of special types of reserve power; see (H7.4).

**(H7.112)** Destroyed batteries lose their reserve power capability; see (H7.38). Repaired batteries can be used for reserve power, but are empty when repaired and must be recharged.

**(H7.12) TIME OF EFFECT:** If reserve power is used to activate some system during the turn (say, electronic counter measures or reinforced shielding), this takes effect from that point until the end of the turn. It is not retroactive to the beginning of the turn, nor does it carry over into the next turn. For example, one point of power allocated to ECM will provide that ECM strength for the entire turn, but a unit of reserve power added to the ECM during the turn will, by definition, produce only a part of a turn's ECM. This is the penalty for the flexibility gained.

**(H7.13) RESTRICTED TIME OF USE**

**(H7.131)** Reserve power is normally withdrawn from the batteries at the time (i.e., at the specific point in the Sequence of Play) that it is used. There are no restrictions on such withdrawals.

**(H7.132)** Reserve power may also be transferred from the batteries to various systems which will be used later.

For example, a player notes on Impulse #12 that enemy drones are approaching and transfers reserve power to the tractor beams at that time, even though the drones will not be within tractor range for several impulses. He might do this in anticipation of losing batteries to enemy direct-fire damage on the next impulse, when he will be within the firing arc of a mauler.

Such transfers (which could be for any legal purpose, not just tractors) can only be done at the end of each impulse. This "delayed use reserve power" is then treated simply as allocated power. At the moment the power is withdrawn for this expected use, the battery is regarded as having discharged the corresponding amount of energy. This power is considered to be expended at the moment in which it is withdrawn. This is not the same meaning for "expended" as used in (D22.0).

**(H7.133)** Reserve power used to initiate the arming of a wild weasel (J3.122) or fighter reload box (J4.88) is transferred during the Shuttle Launch Step.

**(H7.134)** One of the most critical moments for the user of reserve power is at the time that damage is scored on the ship. After damage is scored (i.e., after die rolls, the movement of seeking weapons, asteroid, etc.) and the number of damage points is known, there are relatively few things that reserve power can be used for (before the internal damage is actually allocated, with the chance that batteries might be destroyed). These include the following options only:

- Reinforcing shields and providing general reinforcement, but not raising them or increasing their level.
- Increasing the level of PA panels.

**TACTICS:** Entire doctoral theses at Star Fleet Academy have been written on this subject. Expert players will know instinctively how many internal damage points must be scored on their shields to reach (and destroy) the batteries. For example, three overloaded photons striking the #2 shield of a Klingon D7 will cause 26 internals, an amount that will almost certainly destroy the batteries (given average distribution of die rolls on the DAC, this would take about 18, due to the shortage of forward hull on most Klingon ships). In this case, an expert Klingon captain would discharge the batteries into shield reinforcement so that the energy would not be completely lost. A Federation CA, with plenty of forward hull, will probably still have most of its batteries after a volley of 20 internal damage points and would lose them to a volley of 36.

### (H7.2) SOME USES OF RESERVE POWER

Reserve power can (within the limits of the rules) be used to:

#### SYSTEMS

- Increase the amount of ECM or ECCM (D6.315) being generated or lent by (G24.2214) or (J4.93). Generate reserve EW for use under (G24.211).
- Raise shields or increase their level (H7.34).
- Reinforce shields (H7.34), even after damage is scored (H7.134) or a boarding attempt is announced (H7.341).
- Activate or reinforce PA panels (D10.24); see (H7.346).
- Activate a cloaking device (G13.21).
- Operate mine detecting systems (M7.21).
- Activate active fire control (D6.6).
- Provide power for tractors (G7.411) or transporters (G8.13).
- Begin arming a wild weasel (J3.12).
- Increase speed through (C12.24), use warp tactical maneuvers (C5.2), begin erratic maneuvers (C10.11), or make an HET (C6.2); these are movement-related functions which can be performed with reserve warp engine power (H7.4) only.
- Use sublight tactical maneuvers (C5.1), begin erratic maneuvers (C10.112), or accelerate (C12.25); these are impulse-movement-related functions which can be performed with reserve impulse engine power (H7.47) only.
- Lay (G10.2) and reinforce (G10.33) web.

#### WEAPONS

- Fire weapons which can be armed in one turn (H7.5). Reserve power cannot be used to arm a weapon which was fired or discharged on the same turn; exception: phasers, PPDs firing over a turn.
- Overload weapons otherwise ready to fire (H7.54).
- Overload (but not fire or begin loading) a PPD (E11.24). PPDs cannot receive reserve power while firing.
- Begin arming multi-turn weapons (H7.53) and other systems (H7.32).
- Energize phaser capacitors (E2.33).
- Begin arming a suicide shuttle (J2.22).
- Complete a plasma torpedo held with rolling delay (FP1.91) or complete it for fast firing (FP1.93).
- Increase the power in the capacitors of weapons that use them.
- Add power to unreleased ESGs (G23.21), stasis field generators (G16.2), snares (E13.2), or web casters (E12.3).
- Arm fighter heavy weapon energy storage systems (J4.89).

The above is only a partial list of the possible uses of reserve of power. This entire rule (H7.2) is not technically a rule, but is simply a list of cross-references; details on these uses are included in the

rules referenced above. Some other uses (or prohibitions) are listed in the various rules relating to those uses.

### (H7.3) RESTRICTIONS

**(H7.31) FREQUENCY OF OPERATION:** Even with reserve power, a given system cannot be operated more often than the rules allow. For example, a given transporter can only be used once per turn. [Exception: (D21.31).] This could be done with energy allocated at the start of the turn or with reserve power provided at any point during the turn. A given transporter could not be operated twice in one turn using allocated power one time and batteries the other.

**EXAMPLE:** A Klingon D7 has all three batteries remaining, and each of them is holding one unit of power. During the turn, an unexpected opportunity to board an enemy ship occurs. Power had not been allocated for transporters, but the Klingon player can draw it (one point, which will power all five of his transporters as they cost 1/5-point each) from one of the batteries. This requires an adjustment of the battery records as it was not listed on the Energy Allocation Form. Later in the same turn, the enemy ship fires on the D7, delivering a minor four points of damage to the forward shield. This shield had been reinforced specifically with two units of power. This negates two of the four damage points. Rather than accept the other two points of damage onto the front shield, the Klingon player elects to discharge his reserve power (the two remaining points in the batteries) into the front shield, canceling the other two points of damage. Thus, none of the damage is permanent.

**(H7.32) MULTI-TURN CHARGING SYSTEMS** [e.g., Displacement Device (G18.0)] can begin charging with reserve power, but cannot do so on a turn during which the system has been used.

Reserve power cannot be used to continue multi-turn charging begun in a previous turn because, if energy was not allocated at the start of the current turn, the charging sequence was aborted.

**NOTE:** None of these systems are in the Star Fleet Battles Basic Set although some weapons (H7.53) have similar restrictions. Wild weasels are covered under (J3.122). Also note that power from batteries used during Energy Allocation is not reserve power and avoids these restrictions.

**(H7.33) ELECTRONIC WARFARE:** Reserve power can be used to increase electronic warfare (D6.312) levels (within other limits), but this can only be done in the Fire Decision Step; see (D6.315). Reserve power cannot be used to adjust EW at other points (such as between the point when direct-fire weapons fire is announced and the point when it is resolved or between the point when a seeking weapon enters the target's hex and when the explosion of that weapon is resolved).

**(H7.34) SHIELDS:** Reserve power can be used to raise or reinforce shields under certain conditions.

**(H7.341)** Reserve power can be used to raise shields after a transporter action has been declared and before it is resolved (G8.23).

**(H7.342)** Reserve power can be used to reinforce a specific shield (D3.342) even after damage is scored (i.e., the number of damage points is known) on that specific shield and before the damage is applied (H7.134). It cannot be used to raise them (H7.345) in this case.

**(H7.343)** Reserve power can be used to provide general reinforcement (D3.341) after a transporter action is declared or completed (G8.23). Note that this can be done only in increments of two energy points.

**(H7.344)** Reserve power can be used to provide general reinforcement, even after damage is scored on the ship (i.e., the number of damage points is known) and before the damage is applied (H7.134). This would normally be done only in the case of damage to a down shield. Note that this can be done only in increments of two energy points.

**(H7.345)** Reserve power *cannot* be used to raise shields (or to increase minimum shields to standard shields) after damage has been scored and before it is resolved, but could be used to reinforce a (minimum or standard) shield at that time (H7.342).

**(H7.346)** Andromedan PA Panels use the same procedure as shields. Increasing PA panels from standard to reinforced level is considered reinforcement, not an increase in level. Raising them from

inactive to either standard or reinforced level is raising, not reinforcing, PA panels.

**(H7.35) PROHIBITED USES:** Reserve power cannot be used for Damage Control (D9.0), Repair (G17.0), Emergency Damage Repair (D14.0), or braking energy (C3.53).

**(H7.36) BATTERIES:** Unused reserve power remains in the batteries (or goes to the batteries in the case of reserve warp or impulse power) at the end of the turn. The player may channel some or all this power into the phaser capacitors if there is space in the capacitors for the power. Also note that power from the batteries can be sent to phaser capacitors on the same turn that the capacitor is emptied by firing the phasers. This is a particular tactic used by Andromedans to create extra room in their batteries to put power from the panels into. This redirection of reserve power takes place in the Repair Stage of the Record-Keeping Phase. After the end of the turn, power in the batteries loses its status as reserve warp (or impulse) power and cannot be used for warp-required or movement-related expenditures on the next turn. [Exception: Second-Generation X-ships (H5.5).]

**(H7.37) ANNOUNCEMENT:** In general, players are not required to announce that they are using reserve power to perform a particular action. This expenditure may become apparent when the action is taken or, if the enemy is tracking your power expenditures, he may realize what you have done toward the end of the turn. Records of this expenditure must be kept and produced at the end of the game; this is particularly critical in competitive gaming such as tournaments.

**(H7.38) DESTROYED BATTERIES:** If the battery is destroyed before the power is used, the reserve power (warp or non-warp) is lost immediately and cannot be used later. Because of this, batteries are key targets for hit-and-run raids (D7.8).

**NOTE:** This power could be allocated under (H7.134), but that could only happen before damage was allocated.

#### (H7.4) RESERVE WARP POWER AND OTHER SPECIAL FORMS OF RESERVE POWER

**(H7.40) TYPES OF RESERVE POWER:** Those systems which require the expenditure of warp power (such as overloading normal photon torpedoes just before firing them) can use the reserve power system only under the conditions described in this rule. Specific terms used herein are defined as follows:

- Reserve Power: Can be from any source.
- Reserve Warp Power: Can come from warp engines or warp reactors.
- Reserve Warp Engine Power: Reserve warp power that comes only from warp engines.
- Reserve AWR Power: Reserve warp power that comes only from auxiliary warp reactors. This can be used for anything except movement-related functions.
- Reserve Impulse Power: Reserve power that comes only from impulse engines; see (H7.47).
- Reserve APR Power: Reserve power that comes only from APRs. This cannot be used for any function that specifically requires warp or impulse power.

It is theoretically possible that a single battery might be holding fractional points of power from several or all of the above sources.

**(H7.41) BATTERIES:** Some warp power can be allocated to recharging batteries; see (H7.43). This cannot be more than the capacity of the discharged batteries. This specific warp power, and no other warp power, is treated as reserve warp power. Otherwise unallocated warp power cannot be used as reserve power. Note: Warp power from AWRs is restricted by (H7.45).

**(H7.42) POSSIBLE USES:** Reserve warp power and reserve AWR power can be used for anything that normal reserve power can be used for. In addition, it can be used for non-movement warp-specific purposes (e.g., photon torpedoes, arming probes as weapons, displacement devices, arming suicide shuttles, etc.).

Reserve warp engine power can be used for any of the above plus for movement-specific purposes, such as to increase speed

(C12.24), conduct EM (C10.113), execute tactical warp maneuvers (C5.2), or perform an HET (C6.22).

Unused reserve warp power is used to recharge the batteries at the end of the turn and ceases at that point to be treated as reserve warp power. See (H7.36) and (H7.43). There is an exception for Second-Generation X-ships in (H5.5).

Reserve warp (or impulse) power cannot be used for braking (C3.53).

**(H7.43) ENERGY CYCLE:** Batteries can be discharged and energy allocated to recharge them at the same time. The most common procedure is to use whatever power is in the batteries for various functions (which cannot include recharging batteries) during Energy Allocation, and then to allocate warp engine power to recharge the batteries. That warp power is then treated as Reserve Warp Engine Power (H7.41), which is the most flexible type of reserve power.

This is a very common practice, and it is regarded as a "standard operating procedure" when there is sufficient unallocated warp power available. Players are not required to use this procedure, but are advised that doing so will provide the maximum amount of reserve warp engine power, which is the most flexible type.

**EXAMPLE:** A Federation CA, which has four batteries, could discharge them (for systems that don't require warp power) during the Energy Allocation Procedure and assign four units of warp engine power to recharge the expended batteries. (It can be presumed that the other 26 units of warp engine power are used for movement, photon torpedoes, etc.) These four points of reserve warp engine power can be used for any purpose that reserve power can be used for, plus they can be used for those operations specifically requiring warp power (such as overloading the photon torpedoes).

The player could have chosen, during the Energy Allocation Phase, to leave the four batteries charged and to use the four units of warp engine power for systems that do not require warp power, but in that case his reserve power would be limited to non-warp and non-movement functions.

**(H7.44) ANNOUNCEMENT:** Players are not required to announce the use of reserve warp power to increase the speed of the ship (or the number of warp TACs). The increase in speed will be noticed, but by appearances could theoretically have come from original allocations using (C12.0).

**(H7.45) WARP REACTORS:** Power from AWRs (H4.3) cannot be used for movement or movement-related functions (EM, HETs, TACs, etc.), even if used as reserve power.

Similarly, "reserve AWR power" could be used for any warp-specific purpose except movement-related purposes.

**(H7.46) DESTROYED BATTERIES:** If the battery is destroyed, the associated reserve power is lost; see (H7.38) for specifics.

**(H7.47) RESERVE IMPULSE POWER** uses the same procedures as reserve warp power but is limited to impulse functions, such as Erratic Maneuvers (C10.113) and other non-warp functions. If the ship did not allocate impulse power for movement, using one point of reserve impulse power would increase the speed of the ship by 1 for the remainder of the turn; see (C2.111) and (C12.25). Reserve impulse power can also be used for sublight tactical maneuvers (C5.1) which can be important, as warp and sublight TACs can follow each other.

**(H7.48) USE OF RESERVE WARP POWER:** The following examples are provided as tactical advice. They are not the only uses for reserve warp power.

**A.** High energy turns are the #1 use of reserve warp (engine) power. As many ships do not have sufficient battery capacity to pay for an HET, this is often combined with Contingent Reserve Power (H7.6).

**B.** Reserve warp power can be used to overload photon torpedoes (or other weapons) at the instant of firing. This provides increased flexibility in that the position of the enemy cannot be predicted. If the enemy is beyond eight hexes, it would be a waste to have overloaded weapons in the tubes when they cannot be fired.

**C.** Another use of reserve warp engine power is to allow the ship to perform tactical warp maneuvers (C5.2) after stopping with emergency deceleration (C8.0) or when halted during part of the turn using (C12.0).

D. Reserve warp engine power can be used to increase speed (C12.24) in mid-turn.

E. Reserve impulse power can be used for a large ship (those with move costs larger than 1.0) to allow it to begin erratic maneuvers (C10.113) for less energy than reserve warp would require.

**(H7.49)** Reserve warp power can be used to execute a high energy turn before allocated power for such an HET is used. If the allocated power is never used, it would simply be lost. An Andromedan ship would treat such allocated power as never generated under (D10.74).

#### **(H7.5) USE OF RESERVE POWER FOR WEAPONS**

**(H7.51) TIMING:** The use of reserve power does not permit violations of the timing rules of weapons. For example, a phaser-1 could not fire twice in one turn, once with energy originally allocated to the capacitor and again (or previously) with reserve power.

**EXAMPLE:** A gatling phaser has been fired three times thus far in a turn. The capacitor is emptied by a phaser-1 on Impulse #26 before another firing opportunity presents itself for the phaser-G on Impulse #30. Rather than pass up the shot, the player moves 1/4 point of reserve power to the capacitor and fires. Early in the next turn the gatling phaser fires twice more (using newly allocated power) on Impulse #3 and once more with reserve power on Impulse #4. It can not fire a fourth time until Impulse #6 (E2.15), regardless of whether it will use allocated or reserve power to do so.

**(H7.52) SINGLE-TURN ARMING:** Reserve power can be used to arm a one turn weapon, whether about to fire or not. Such a weapon cannot be armed with reserve power on a turn it has already fired.

**(H7.521)** Gatling phasers are an exception to this rule; see the example in (H7.51).

**(H7.522)** Energy can be transferred into a phaser capacitor (assuming that it has the capacity to hold it) whether the phasers are being fired or not.

**(H7.523)** Reserve power cannot be transferred to a fusion beam during the cooling turn; see (E7.22).

**(H7.524)** While maulers use batteries (E8.32) to fire (E8.12), this is more correctly under their own rules than as reserve power.

**(H7.525)** Reserve power cannot be used to fire a weapon which was fired or discharged on the same turn. For example, an overloaded weapon could not be discharged and then fired with reserve power after learning that the enemy will not be within overload range.

**(H7.53) MULTI-TURN ARMING** weapons can begin arming with reserve power, but cannot do so on a turn during which the weapon has been fired (or ejected). Exception: PPD (E11.23) and (E11.24).

**(H7.531)** Reserve power cannot be used to continue multi-turn arming begun in a previous turn because, if the energy is not allocated at the start of the current turn, the arming sequence is immediately aborted. The same is true of holding energy. Remember that the energy provided by a battery during the Energy Allocation Phase is considered to be allocated power, not reserve power (H7.11); it may be used to continue the arming of a multi-turn weapon (if it doesn't require warp energy).

**(H7.532)** A two-turn arming weapon cannot be fired within eight impulses of the point at which arming was started with reserve power. For example, a photon torpedo might receive two points of reserve warp power on Impulse #32 of Turn #6, then two points of allocated warp power during the Energy Allocation Phase of Turn #7, but it could not be fired before Impulse #8 of Turn #7.

**(H7.54) OVERLOADS:** Reserve power can be used to provide overload energy to a weapon, whether about to fire or not (assuming the weapon has an overload function). This includes additional overload energy to a weapon, such as a photon torpedo, with variable overload levels.

See (E11.63) for specifics in the case of PPDs.

The application of reserve warp power to overload a photon torpedo would not increase the holding cost unless the torpedo is held until the end of the turn, when the cost would be increased for the next turn; see (E4.412).

**(H7.55) PLASMA TORPEDOES:** Reserve power can be used in several special ways for plasma torpedoes. See (FP1.9).

#### **(H7.6) CONTINGENT RESERVE POWER**

**(H7.61) CONCEPT:** For increased flexibility, players can use the contingent reserve concept. Under this procedure, part of the energy cost of a desired action is paid during Energy Allocation, with the remainder supplied by reserve power only when and if the action is performed. The player is not required to provide the remainder; see (H7.62). A partial list of functions that can be allocated in this manner includes: HET, EM, weapons, etc.

**EXAMPLE:** A ship requires five points of power to perform an HET. The player allocates three points and supplies the other two points from reserve warp engine power only when (and if) he is ready to perform the HET.

**(H7.62) LOSS IF INCOMPLETE:** The player is not required to complete the contingent allocation. The player could decide not to supply the remaining power, could use his reserve power elsewhere, could have lost his batteries to damage, or (D22.0). If the reserve power is not supplied, the power allocated for that function is irrevocably lost at the end of the turn.

**(H7.63) RESTRICTED USES:** This procedure cannot be used for functions which require continuous power supplies. For example, you could not allocate part of the operating cost of an operating cloaking device because without full power the device would immediately cease to function and the ship would be exposed. (An uncloaked ship that wanted to allow for cloaking later in the turn could, of course, use the contingent reserve procedure to pay part of the cost of a future activation of the device.) Similarly, the ship cannot pay part of the cost of holding a torpedo because, if the entire cost is not paid, the torpedo will be ejected.

**(H7.64) OVERLOADS:** Contingent reserve power does not escape the provisions of weapon overloading rules. Allocating power to partially overload a weapon irrevocably results in an overloaded weapon, which cannot (unless noted otherwise, as in the case of photon torpedoes) be fired unless the full amount of energy is provided (presumably by reserve power) and cannot be un-overloaded. Thus, this procedure should not be used by a player who is uncertain if the target will come into overload range, as the weapons would be limited to that range with the first point of allocated overload power. A better tactic would be to fully-overload some weapons and count on reserve power to overload others.

**(H7.65) SIMILAR USAGE WITH CAPACITORS:** Some weapons or other systems have capacitors able to hold power; e.g., phasers and ESGs. An effect similar to contingent reserve power can be created. For example, a player could allocate 1/4 point to his phaser capacitors (on a ship with only ph-2s), knowing that he must provide the other 3/4 points from reserve power or the phaser-2 cannot fire. If the other 3/4 points are not allocated, the 1/4 point remains in the capacitor for the next turn. Note: The player could have provided 1/4 point of reserve power and fired the ph-2 as a ph-3 under (E2.25).

#### **END OF SECTION (H0.0) BASIC SET**

**NOTE:** The Letter "I" is not used in the SFB rules numbering system because of possible confusion with the numeral "1."

## (J0.0) SHUTTLECRAFT AND FIGHTERS

Shuttlecraft are small (10 meters long) spaceships carried inside the larger starships. Their primary purpose is administrative, carrying personnel, supplies, equipment, mail, etc., from the ship to other ships or the surface of planets. In combat situations, however, these craft are often used for many other purposes.

In later years, highly developed armed shuttlecraft (termed "fighters") were often used to increase a ship's firepower. These fighters became an important factor in the defense forces assigned to bases and planets.

It should be noted that fighters are not within the "original source material" for the game background. Some players may find this addition to the background to be offensive to their sensibilities and may choose to ignore fighters entirely. This can be accomplished by ignoring rules (J4.0), (J5.0), (J6.0), (J7.0), [possibly (J9.0)], and (J10.0), as well as all carriers and carrier escorts. This will probably also require deletion of the Hydrans (in Module C1, or at least most of their ships) and various extensive adjustments in the campaign systems which are left to players making such a decision.

Basic Set includes the standard shuttlecraft, often known as "administrative shuttles" or "utility shuttles," and the Kzinti AS (or AAS) fighter. Advanced Missions and Module J include many more fighters, carriers, and escorts.

**DEFINITION:** The term "shuttle" (which is interchangeable with "shuttlecraft") includes both non-combat shuttles (the most common of which are "administrative shuttles") and "fighters." Administrative shuttles are the large, box-like transport shuttles used to carry personnel and perform other tasks; fighters are generally single-seat attack craft designed only for combat. Sometimes, for emphasis, the term "shuttles (including fighters)" is used; this does not indicate that fighters are not included within the generic term "shuttle" in any other cases.

### (J1.0) GENERAL RULES

Shuttlecraft are not ships, but a separate type of unit. They operate within a different set of rules, which are presented here.

#### (J1.1) ENERGY

Shuttles do not fill out an Energy Allocation Form. They do not use the energy allocation system to move or fire their weapons or to perform any other function. Some special systems (e.g., wild weasels, suicide shuttles, fighter non-phaser energy-weapon reloads) require power to be allocated by the ship which is operating the shuttles.

#### (J1.2) MOVEMENT

The movement rules for shuttles are considerably simpler than those for ships.

**(J1.21) SPEED:** Shuttles are assigned a maximum speed based on their type; this is shown on Annex #4 Master Fighter Chart. Shuttles may move at any speed up to this maximum, but must announce their speed at the start of each turn (when ships do). If no speed is announced, the maximum speed is assumed.

**(J1.211)** Shuttles can change speed in mid-turn using (C12.34). If you only have Basic Set, shuttles remain at their announced speed for the entire turn. Shuttles can, by manipulating speed changes, actually move more hexes in a turn than their listed maximum speed.

**(J1.212)** Shuttles are destroyed if towed by tractor beam at more than twice their currently allowable maximum speed; see (G7.54). This speed is judged without the effects of: warp booster packs (J5.21), ECM pods (J4.9621), or pilot status (J6.2). Crippled shuttles are destroyed at a lower speed; see (J1.331). This is known as "death dragging" to veteran SFB players. See (J4.121) for the escape maneuver fighters can use.

**(J1.22) ACCELERATION, DECELERATION:** A shuttle may accelerate by up to one-half of its maximum speed (round up) at the start of a given turn (up to its maximum speed). This maximum speed is not adjusted for warp packs, damage, pilot quality, EW pods, etc.

**(J1.221)** A shuttle may be launched at its maximum speed, as adjusted for damage, warp packs, pilot quality, EW pods, etc.

**(J1.222)** A shuttle may decelerate by any amount (between turns); deceleration during a turn is limited by (C12.34).

**(J1.223)** A shuttle or fighter can use emergency deceleration (C8.0), but the lost movement points produce no "shield benefit." See (J4.13) in the case of fighters.

**(J1.224)** The total acceleration (and deceleration) during a turn under (C12.34) may not exceed half of the maximum speed as defined in (J1.22). Acceleration and deceleration is based on the speed of the shuttle without the effects of warp booster packs. The one activation or deactivation of warp packs allowed during the turn (J5.14) is in addition to the normal number of speed changes and the acceleration/deceleration limits.

**(J1.23) TURN MODE:** All shuttles have a turn mode of 1 at speeds 1–11, a turn mode of 2 at speeds of 12–23, and a turn mode of 3 at speeds of 24 and higher. A manned shuttle can change facing by one or more hex sides on Impulse #32 of any turn in which it did not move. (This is done as an HET, even if the shuttle cannot normally perform an HET.)

**(J1.24) REVERSE MOVEMENT:** Shuttlecraft cannot move in reverse. (They can, of course, be pulled backwards by a black hole or tractor.) Remember, "shuttlecraft" includes fighters; see (J0.0).

**(J1.25) NIMBLE UNITS:** Shuttles are "nimble units" (C11.0). Shuttles may, as a consequence of this status, use erratic maneuvers at a cost of one point of speed (C10.13) among other benefits. They can land on planets; see Annex #7B.

**(J1.26) MANEUVER ON LAUNCH:** Shuttles may change speed or make a high energy turn after launch without waiting for the required "delay" from a "previous" such maneuver. These actions are taken within the rules and within the normal Sequence of Play. The turn modes of shuttles are not satisfied at the time of launch. Shuttles may be launched on erratic maneuvers (i.e., begin performing EM at the instant of launch). [Note: As of the date of this edition, no non-fighter shuttle in the game system could perform an HET.]

#### (J1.3) COMBAT

All shuttles are capable of participating in combat. Some are capable of surviving combat. Fighters can even participate offensively.

**(J1.31) WEAPONS:** Shuttles carry weapons as specified by the rules on each type of shuttle and by the Master Fighter Chart (Annex #4). No shuttle (including fighters) can fire a direct-fire weapon to a range of more than 15 hexes. (Some weapons have shorter ranges specified, for example, photons are limited to range 12, disruptors to range 10.) This range limit is not adjusted by pilot status. Shuttles with multiple direct-fire weapons can fire any or all of them on any impulse at one or more targets in arc unless specifically prohibited from doing so by their own rules. A shuttle armed with direct-fire and seeking weapons can launch the seeking weapons at the same or a different target that it fires direct-fire weapons at on the same impulse.

Shuttles can use passive fire control; see (D19.27).

All shuttles have a sensor rating of 6 (D6.133) and a scanner rating of zero (D6.22). See also (J1.333).

**(J1.32) DAMAGE:** Shuttles can be fired at by any weapons. This fire may be adjusted for range; see (E1.7).

**(J1.321)** As shuttles do not have SSD sheets with boxes for engines, weapons, pilot, etc., damage is not "allocated," but simply recorded for each shuttle. All ships have a track to record damage points on their shuttles, and many carriers have "mini-SSDs" for their fighters (damage check-off boxes arranged in the shape of a fighter) on their own SSDs.

**(J1.322)** Each type of shuttle has a specified "destruction point," that is, a number of points of damage that will destroy it. When the

number of points of damage scored on a given shuttle equals or exceeds this destruction point, the shuttle is destroyed and removed from the game.

**(J1.33) CRIPPLING:** Shuttles are considered "crippled" when the number of damage points scored on them equals or exceeds 2/3 of their destruction point. (Round fractions to the next larger whole number when calculating the number of points required for crippling; a shuttle destroyed by 8 damage points is crippled by 6.) The following penalties take effect immediately after the step in which the crippling damage was received.

**(J1.331) SPEED:** When a shuttle is crippled, its maximum speed is reduced to 1/2 of its rated maximum (round fractions up; a shuttle with a speed of 11 can move 6 when crippled).

**(J1.3311)** The current speed, if more than the new crippled maximum, is immediately reduced to that crippled maximum. This is considered a speed change under (C12.34), and while it may occur at less than the required interval from the previous change, the next change must wait the required interval from the point of a speed change required by crippling.

**(J1.3312)** A crippled shuttle can be destroyed by tractor beam when towed at a speed exceeding its original maximum speed; see (J1.212).

**(J1.332) WEAPONS:** All weapons carried externally on a crippled shuttle (drones, type-D torpedoes, EW pods, other external weapons added later) must be dropped. All internal weapons (including EW pods) except phasers cease to operate. The standard chaff carried on a fighter (D11.0) is unaffected.

**(J1.3321)** All phasers (including ph-Gs) on crippled shuttles are reduced to phaser-3. No more than one phaser can fire into each arc. If two phasers have the same arc (e.g., F-18), one ceases to function. If the arcs overlap completely, the one with the smaller arc ceases to function. If the shuttle has phasers with BS arcs, these remain and any others cease to function. If the shuttle has FX and RX phasers, both remain but the RX is reduced to RA. If a gatling phaser has fired three or fewer times during earlier portions of the turn (that it was reduced by crippling), the resulting phaser-3 can fire later during that same turn. The firing arcs of phasers remain unchanged except as specified herein.

**(J1.3322)** EW systems (EW pods, MRS, SWAC) cease to function if the shuttle is crippled. Built-in EW points continue to operate.

**(J1.3323)** The drones on a scatter-pack are not dropped; see (FD7.48). This includes plasma-Ds on a fighter-SP. Crippled suicide shuttles do not jettison their bombs.

**(J1.3324)** Any armed non-phaser energy-using weapons are discharged (E1.24).

**(J1.333) SENSORS:** The sensor rating of a crippled shuttle is not reduced (D6.133). A crippled shuttle can control seeking weapons (assuming it could before it was crippled).

A crippled shuttle can receive EW lending, but cannot loan EW points. A crippled shuttle cannot perform an HET or EM.

The scanner factor of shuttles (D6.22) is not reduced when they are crippled.

**(J1.334) REPAIR:** The effects of crippling are removed when the shuttle is repaired to a point exceeding the crippled level. This can be done by deck crews or repair systems, but only in a shuttle bay or a shuttle-link (J1.56). Exception: Legendary Engineer (G22.45).

**(J1.335) CAPTURE:** A crippled shuttle in an enemy shuttle bay is easily captured by boarding parties; see (D7.632).

**(J1.34) RESTRICTIONS ON LAUNCH:** Newly launched shuttles are under various restrictions. These restrictions apply if launching from a friendly or enemy ship and regardless of the manner of launch, whether from bay, balcony, or mech-link. Remember that all "fighters" are "shuttles."

**(J1.341) SEEKING WEAPONS:** A shuttle cannot launch or guide seeking weapons until 1/2-turn (16 impulses) after its most immediately previous launch. See (J4.31). Exception: Scatter-packs can release their seeking weapons after 1/4 turn; see (FD7.33) and (FD7.44).

**(J1.342) DIRECT-FIRE WEAPONS:** A shuttle cannot fire direct-fire weapons for 1/4 turn (8 impulses) after its most recent launch. See (J4.32).

**(J1.343) OTHER SYSTEMS:** A shuttle cannot loan EW points, lay (R1.F6) or sweep (R1.F2) mines, or collect information for 1/4 turn (8

impulses) after its most recent launch. See (J3.33). A web spinner (G10.24) can perform that function immediately upon launch. A shuttle can receive EW lending immediately upon launch.

**(J1.4) RECORD KEEPING**

Each SHUTTLE box on the SSD represents the capacity to operate one administrative shuttle or fighter.

Exceptions: Poor crews (G21.133) cannot use some of their shuttles; overcrowding (J1.64) and crash landing (J1.65) allow extra shuttles to be taken into the bay.

In some cases the boxes on the SSD are differentiated as to one type or the other; in other cases the number of each type is shown in the ship specification in section R.

**(J1.41) SSD BOXES:** The box on the SSD represents both the shuttle and its space in the hangar bay.

**(J1.411)** When a shuttle is launched, the corresponding box on the SSD is marked with a dot (or any other convenient mark) indicating that the shuttle has been launched. The number of undestroyed boxes on an SSD will indicate the carrying capacity of the ship, while the number of boxes without special marks will indicate the number of shuttles still on board.

**(J1.412)** When a shuttle hit (point of internal damage allocated to shuttle) is scored, the owning player may score it against a shuttle box that contains a shuttle (destroying the shuttle and the capacity to operate it) or one that does not, at his option. See (J10.13) in the case of heavy shuttles.

**(J1.413)** When a hit-and-run raid (D7.8) is launched against a shuttle bay (or at the start of each turn, if the players wish), the owner (of the ship the bay is on) notes (on scratch paper) each of the boxes in that bay and what is in it (damaged fighter #3, scatter-pack, wild weasel being charged, empty, fighter being guarded by Marine Squad #2, etc.). The player conducting the hit-and-run raid then rolls a die to determine which box his marines actually landed in; more than one may have landed in the same shuttle box. Each raid independently in an exception to (D7.84). (If there are six or fewer boxes, one die roll will suffice; re-roll if the result is more than the number of boxes. If there are more than six, divide the bay into groups of 6 boxes, roll one die to select the group and another to select the box in that group.) The entire record is revealed at the end of the turn. This procedure is used for several rules.

**(J1.414)** A shuttle box (with a shuttle in it) may be destroyed on an "any weapon" hit; see (D4.324). An empty shuttle box cannot be.

**(J1.415)** Hits on boxes containing armed shuttles may cause a chain reaction; see (D12.0).

**(J1.416)** Every shuttle on board the ship is assigned to a specific shuttle box at all times. The box for arriving shuttles is designated when they land. Exception: Overcrowding (J1.64) effectively creates "extra shuttle boxes." See (J1.663) to land shuttles in a destroyed shuttle box.

Shuttles can be transferred between boxes of the same bay [or a different bay, see (J1.59)] during the Record Keeping Phase at the end of the turn.

No more than one shuttle can be in any given box; exceptions (J1.64) and (J1.65).

**(J1.42) SPARE SHUTTLES:** Most ships have more shuttles on board than they can conveniently operate. Shuttles in excess of the shuttle boxes on the SSD are stored as "spare shuttles" for later use.

**(J1.421)** The number of spare shuttles on any given ship is shown on the Master Ship Chart (Annex #3).

**(J1.422)** As it would take 100 turns to bring a stored shuttle to the bay and prepare it for use, these normally come into play only during campaigns where shuttle replacements are not immediately available. Spare shuttles can only be used in a subsequent scenario if the ship has an undestroyed shuttle box for that specific shuttle to operate from.

**(J1.423)** Outstanding crews (G21.233) can prepare one of their spare shuttles during a scenario.

**(J1.5) LAUNCHING SHUTTLES**

**(J1.50) LAUNCH RATE:** A given shuttle bay (J1.51) may not launch or recover more than one shuttle during any given impulse or two consecutive impulses, except as specified herein or in the individual



ship descriptions. Note that a given bay can launch OR recover a shuttle, it cannot do both at the same time (in any two consecutive impulses).

**(J1.501)** Shuttles can be launched facing in any direction. The speed of the launching ship has no effect on a shuttle being launched; this is not the case with a shuttle being landed; see (J1.6).

**(J1.502)** Dropping a mine from the shuttle bay (M2.11) effectively takes the place of a shuttle launch or recovery.

**(J1.503)** A shuttle can be launched at any speed; (J1.221).

**(J1.504)** Shuttles are under various restrictions during the period after launch; see (J1.34).

**(J1.505)** The speed of the launching ship has no effect on a launched shuttle.

**(J1.506)** Shuttles launch from planets and ground bases on planets by (P2.412).

**(J1.51) NUMBER OF SHUTTLE BAYS:** A shuttle bay can consist of one or more shuttle boxes. Each bay is a separate compartment (i.e., room) on the ship designed to service, launch, and recover shuttles.

The number of bays on a ship may be apparent from the SSD (all contiguous boxes are part of a single bay, but on some SSDs a bay is divided into two groups of boxes for artistic purposes), but specific information is given in the technical details for each ship and in Annex #7G (in Module J) showing information on carriers. Non-carriers are shown in Annex #7M. Many SSDs include information on the number of bays as part of the Shuttle Track.

**(J1.52) LAUNCH-LAND SEQUENCE:** A shuttle can launch once per turn. A shuttle can land once per turn. A shuttle can launch and land during the same turn (in either order), but cannot perform either action twice in the same turn. There is a minimum 1/4-turn delay between launching and landing, except that a shuttle may land under (J1.62) less than 1/4 turn after it is launched.

Escape under (D21.41) may be done in violation of these limits.

**(J1.53) BALCONY AND TRACK SYSTEM:** Certain ships are equipped with a "balcony and track" system. Shuttles may be moved from the bay onto a balcony (on Gorn ships this is usually on the wings) outside the ship by a mechanical track system. Movement from this outside track to and from the hangar bay is limited by (J1.50), but any number (up to the ship's limit) may be landed on or launched from this balcony during a given impulse. This system allows strike groups to be launched and recovered quickly.

**(J1.531)** If the ship takes damage while shuttles are on the outside balcony, each "aft hull" damage point destroys one shuttle (instead of one hull box), but no chain reactions (D12.0) will occur. This is not an option; the damage point must be scored on the shuttles if any are on the balcony. Shuttles on the balcony cannot fire, and enemy shuttles cannot land or be brought down on the balcony. Shuttles on the balcony cannot be prepared for special missions (WW, suicide, SP), or rearmed or repaired by deck crews (J4.8).

**(J1.532)** A ship can launch shuttles from the balcony at any speed up to 31. A ship can land shuttles (J1.6) on the balcony at any speed (and by any method) that it could land them in the hangar. Shuttles are moved between the bay and the balcony at the launch/land rate for that bay (J1.50); note that each balcony is associated with a specific shuttle bay. The rate in (J1.50) includes all launch/land and bay/balcony operations; i.e., a given bay cannot land a shuttle and move another one to the balcony during the same two-impulse cycle. [Aces (J6.23) in speed-15 fighters with warp packs are, in the current rules, the only fighters able to go speed 31.]

**(J1.533)** Shuttles can remain on the balcony at any speed up to 31. Any shuttles on the balcony when the ship disengages by acceleration (i.e., exceeds a speed of 31) are destroyed.

**(J1.534)** Scatter-packs can be held on the balcony; suicide shuttles and wild weasels cannot. The targeting of SPs held on the balcony can be determined on the impulse of launch.

**NOTE:** Some of those ships equipped with "balcony & track" systems include: all Gorn warships, the Federation CVA (and its SCS variants), most ISC carriers, the Klingon D7V, and the various B10 designs. The description for each ship includes information as to how many balcony positions the ship has.

**NOTE TO NEW PLAYERS:** The following rules (J1.54) through (J1.57) describe various types of special shuttle bays used by various ships. None of the ships in Basic Set uses these systems, so a new player can ignore these rules and proceed to (J1.6).

**(J1.54) LAUNCH TUBES:** Most Hydran ships (see Module C1) and some others (B10V, Kzinti SCS/CVA) are equipped with special launch tubes, allowing them to launch several and recover one shuttle from each bay simultaneously (on the same impulse). Specific information for the launch tubes on each ship is given in the technical notes for each ship.

**(J1.541)** Launch tubes can be used to launch fighters but cannot be used to recover (land) them. Each launch tube may be used once in any given period of two consecutive impulses. Fighters cannot be transferred to or from a balcony through a launch tube.

**(J1.542)** Administrative shuttles (including their variants such as MRS, HTS, GAS, MSS, etc.) and heavy fighters cannot be launched through launch tubes.

**(J1.543)** A shuttle bay may have several launch tubes and a standard shuttle hatch. Recovery can only be conducted through the standard shuttle bay hatch at the rate in (J1.50), which can also be used to launch shuttles. Mines can only be dropped through the standard hatch, not the launch tubes. See also (M2.113).

**(J1.55) THOLIAN EXTERNAL BAYS:** The Tholian Black Widow-class CVL and CVA (both in Module J) carry their fighters in individual external bays. Thus, these ships can launch and recover all of their fighters simultaneously, but cannot launch and recover a shuttle from the same bay within two impulses. Tholian carriers cannot drop mines or T-bombs from their external bays. Also see (J1.642).

**(J1.56) SHUTTLE MECH LINKS:** There are two special types of mech link which can hold shuttlecraft but not PFs.

**(J1.561)** Certain Federation Ships [e.g., SCS (R3.32), NVH (R2.56)] which are PFT substitutes carry heavy fighters on semi-external mech links as seen at right. These are used only to hold heavy fighters (e.g., A-20 or F-111) and are type-specific (those for A-20s cannot hold F-111s or any other fighter or shuttle).

One box is required for each fighter. These are damaged on shuttle hits (a hit destroys the fighter as well as the box, link, and tractor) but can function as tractor beams. Shuttles launch and land in these links as if they were PF mech links, but are repaired by deck crews as if they were in a shuttle bay. They have ready racks for the specific type of fighter embarked. All of the adjoining mech links of this type are treated as a single "bay" for purposes of deploying deck crews, but there can be no chain reaction from one fighter to the next.



**(J1.562)** PF Leaders (K4.1) and Fi-cons (K1.8) have a type of mech link (seen at right) which can hold a shuttle or fighter. The rules for this are in the noted sections; shuttles on this type of link cannot be repaired or rearmed. Mech links of this type are part of tractor beams and are destroyed on tractor hits.



**(J1.563)** Other types of mech links noted in (K2.24) can hold a shuttle, but cannot repair or rearm it.

**(J1.57) SPECIAL CASES:** Some ships are noted in their descriptions as having special or unusual shuttle bay arrangements. An example is the Federation CVA (R2.13) in Module J. Special rules will be given in each case, as these are unique designs with rules used by no other class.

**(J1.58) TUNNEL DECKS:** Some ships (e.g., Federation CVS) have doors at both ends of the bay, allowing shuttles to be operated from both doors at the same time. Each hatch operates independently at the full rate in (J1.50). As the shuttles are fairly easy to move around inside the bay, no particular rules are required for accounting for which door the shuttles entered by or departed from. The Kzinti CV, CVS, CVL, MCV, and CVE have two hatches in the bay (one on the bottom of the ship leading into the rear of the bay, one on the front of the lower hull) and operate as tunnel decks.

**(J1.59) INTER-BAY TRANSFERS:** Some ships with multiple bays have a means of transferring shuttles between the bays internally. (Obviously, any ship can do so by launching a shuttle from one bay and recovering it in the other.) There are two primary types of these systems.

**(J1.591)** Elevators are often used when the two bays are on top of each other, as in the "double-stacked bays" on the Klingon D7V and some other Klingon carriers.

**(J1.592)** Horizontal transfers are used when the two bays are on the same level and are joined by a series of hatches, airlocks, and fire doors.

**(J1.593)** With either system, the procedure is the same. It takes one entire turn, and one deck crew, to move one shuttle between bays. Only one shuttle can be transferred at a time (unless the ship description provides otherwise). The shuttle is considered to be in the original bay for the entire turn for purposes of damage, hit-and-run raids, etc. The shuttle cannot be worked on during the transit turn.

**(J1.594)** It takes one entire turn (starting with Impulse #1) to move any shuttle to another box (or pair of boxes) within the *same* bay.

### **(J1.6) RECOVERING SHUTTLES**

Shuttles can be recovered (that is, taken back aboard a ship) either by being hauled aboard by a tractor beam or by landing on the flight deck under their own control.

**(J1.61) LANDING ABOARD:** This procedure is an unassisted landing by the shuttle. The pilot simply flies the shuttle through the hatch and lands on the shuttle bay deck (or balcony, or shuttle mech link). A shuttle may only land aboard a ship under its own power if both the ship and the shuttle are in the same hex and the ship is not moving faster than the shuttle (current speed of each). If landing aboard an enemy ship, see (J1.63).

**(J1.611)** Only manned shuttles (those with a crew on board) can land aboard by this procedure. Active suicide or WW shuttles cannot land by this method; they can be landed by tractor beam (J1.62).

**(J1.612)** While this procedure is most often used to land aboard friendly ships; it can only be used to land aboard enemy ships if one or more of the shields (just which one is irrelevant) and all general reinforcement is down. In the case of an enemy ship, this may involve blasting the doors open or crashing through them; this can be assumed to have happened without any special procedures by the players. The ship has no opportunity to raise or reinforce shields with reserve power. There must be an available shuttle box in which to land, or see (J1.64) or (J1.65). No shield need be dropped to land a friendly shuttle.

**(J1.62) LANDING VIA TRACTOR BEAM:** A ship can recover a shuttle using a tractor beam, regardless of the relative speeds of the ship and shuttle, if all of the following conditions are met:

1. The ship has a working tractor beam, power has been supplied to it adequate for the range, and the tractor beam is not being used for any other purpose during that turn.

2. The ship is not moving at a speed so fast that the shuttle would be destroyed (J1.212) and (G7.54), even if the shuttle could be landed before destruction nominally occurred. See (J1.505) regarding *launched* shuttles.

3. The ship has an available (empty) shuttle box in one of its bays. See (J1.62), (J1.64), (J1.65), and (J1.66) for exceptions.

**(J1.620) BASIC PROCEDURE:** The tractor is attached to the shuttle. The shuttle is then rotated (G7.7) into the ship's hex. [This rotation is done during the Recover Shuttlecraft Step of the Impulse Procedure on Impulse #32 and forms a partial exception to (G7.71).] At this point, the shuttle may be pulled into the bay (or onto the balcony or mech link) and landed. This procedure cannot be used to land shuttles through an atmosphere faster than (P2.44).

**(J1.6201)** If the tractor was attached to the shuttle at more than one hex range, it will take several turns to pull the shuttle into the bay since it can be rotated only once per turn.

**(J1.6202)** During the period when held by a tractor, the shuttle is moved along with the ship, paralleling its course. Under the conditions of (G7.9), the shuttle may not fire, launch, or guide any weapon. It can operate its own EW systems and accept lent EW points, but cannot lend EW points or gather scientific (G4.13) information. All of these restrictions are released at the instant that the shuttle is released from the tractor, which can be done voluntarily only in the Tractor Beam Step of the Systems Stage of the Impulse Procedure. Rule (G7.91) is a partial exception.

**(J1.6203)** There is no obligation to land a shuttle held in this manner and no difference between a friendly shuttle being pulled along for use in a later attack, an enemy shuttle being held for later execution, and a friendly shuttle being landed.

**(J1.6204)** Any shuttle can be landed by this method, including enemy shuttles (G7.8), unmanned shuttles, derelict shuttles, inert seeking shuttles, active or voided wild weasels, enemy suicide shuttles (watch out!), etc. The same procedure is often used in scenarios to land objects specified for recovery.

**(J1.621) SPECIAL PROCEDURE:** This much faster procedure can be used in the case of a friendly (manned or unmanned) shuttle. It can also be used for an inert shuttle. This procedure might be used for objects recovered as conditions of a scenario (e.g., a recovered probe drone or log buoy).

**(J1.6211)** Whenever the Special Landing Procedure is declared to be in effect, the shuttle shuts down its systems and is under the restrictions of (J1.622).

**(J1.6212)** The ship controls the shuttle. The shuttle moves in the same direction and speed as the ship (paralleling its course as above) but can be pulled one hex closer to the ship (by the ship) each impulse during the Recover Shuttle Step of the Shuttle & PF Stage of the Impulse Activity Segment.

**(J1.6213)** It can be pulled aboard (into the bay, onto the balcony) on the impulse it is pulled into the hex with the ship, or held indefinitely at range zero.

**(J1.6214)** An enemy shuttle can be landed in this manner with the consent of its owner or if it was captured in a dogfight (J7.73). See also (G7.8).

**(J1.6215)** This procedure is an extension of the normal tractor rotation rules (G7.7). A ship could tractor a shuttle and drag it along for a period of time as in (J1.620) without using the "landing" procedures or becoming subject to their restrictions, but the ship would only be able to "rotate" the shuttle (i.e., move it in relation to the ship) once per turn, rather than once per impulse. (This is a standard tactic; see the Tactics Manual. The shuttle must, of course, be released from the tractor before it can fire or launch weapons.) The shuttle could be "towed" for several impulses before the owning player switches to the "landing" procedure. The first impulse on which the shuttle is moved closer to the ship under the landing procedure marks the instant that the shuttle is subject to its restrictions.

**(J1.6216)** This procedure cannot be used to rotate drones.

**(J1.622) RESTRICTIONS:** Certain restrictions and conditions apply to the procedure given above:

**(J1.6221)** This procedure is for landing purposes only. The shuttle cannot be moved farther from the ship. The shuttle cannot fire, operate EW systems, drop chaff, or control weapons while being moved under this procedure. If a shuttle which has been moved by this procedure is released before it lands on the ship, it is treated as a shuttle that was launched on that impulse. The shuttle cannot "begin the launch sequence" while still held in the tractor.

**(J1.6222)** Enemy shuttles can be landed by tractor (J1.620), but cannot be rotated at this once-per-impulse rate unless they agree (J1.6214).

**(J1.6223)** No shuttle can be pulled at this once-per-impulse rate through/into an atmosphere, asteroid, web, planet, moon, or dust cloud hex. Normal tractor rotation is used in those cases. (Obviously, rotation by either method into a hex that would destroy the shuttle could be done but wouldn't be part of a landing procedure.) See (G7.27) for the "forced contact" rule. The shuttle is regarded as having the speed of the ship in each hex it enters when using this system and can trigger a mine.

**(J1.63) SHUTTLES LANDING ON ENEMY SHIPS:** This can occur by either a shuttle (presumably one carrying marines) landing aboard (J1.61) an enemy ship or being pulled on board an enemy ship (J1.620). Situations under (J1.620) are resolved by (G7.8).

**(J1.631)** If friendly and enemy shuttles are aboard a ship, and shuttle bay damage is scored on that ship, the players must determine randomly (by die roll) which shuttle box was damaged. Use the procedure in (J1.413).

**(J1.632)** Shuttle bay hits scored by a shuttle inside an enemy shuttle bay are randomly distributed; see (G7.81).

**(J1.633)** Shuttles landing on an enemy ship can land in "destroyed" shuttle boxes (J1.66). See also (J1.65).

**(J1.634)** A maximum of one enemy shuttle can land in each bay on any two consecutive impulses. This is independent of friendly shuttle operations (J1.50).

**(J1.635)** A shuttle in an enemy shuttle bay can launch from that bay under the normal rules.

**(J1.64) OVERCROWDING:** Shuttles can land on a friendly ship in excess of its nominal shuttle capacity. This allows a ship with its normal full load to accept a shuttle from another ship (for example, carrying a senior officer on an inspection tour).

**(J1.641)** A ship can land one excess shuttle if it has 1–3 shuttle boxes, or two excess shuttles if it has four or more. This is determined in the case of each bay for ships with more than one bay.

**(J1.642)** Tholian external bays (J1.55) cannot be overcrowded.

**(J1.643)** Excess shuttles cannot be rearmed, repaired, or prepared for any special mission.

**(J1.644)** A ship cannot begin a scenario with excess shuttles except in the case of a published historical scenario.

**(J1.645)** In the event of damage points scored on the shuttle bay, the first point destroys the first excess shuttle plus a normal shuttle box (and shuttle), the second point destroys the second excess shuttle (if any) plus a normal shuttle box (and shuttle) i.e., overcrowded boxes must be destroyed first and both shuttles and the shuttle box are lost.

**(J1.646)** A large (double-size) shuttle could land in a single shuttle box by using the “overcrowding” rule.

**(J1.647)** If the overcrowding is resolved (by launching some shuttles), the others are rearranged in the bay by the crew and none are treated under the overcrowding restrictions.

**(J1.65) CRASH LANDING:** Shuttles can land in an already occupied shuttle box (of a friendly or enemy ship), but this action results in the crippling of both shuttles. If either shuttle was crippled at the time, the crippled shuttle is destroyed as a result. If either shuttle was damaged, but not crippled, it is still only crippled as a result.

**(J1.651)** If the shuttles are friendly to the ship, the owning player decides where to land them. If they are enemy shuttles, the specific box used (assuming that no empty boxes are available) is determined randomly by numbering the boxes and rolling a die. However, no box can hold more than two shuttles until all boxes hold at least two. If a third shuttle is landed in a box, it destroys all other shuttles in that box and is itself crippled. Previously crippled shuttles are destroyed, but in either case their occupants can debark immediately as boarders. Destroyed shuttles may cause a chain reaction; see (D12.0).

**(J1.652)** This action would only be taken in desperation (due to its cost) but might be used to recover the shuttles of a lost carrier or to bring on more friendly boarding parties when a ship was in danger of being captured. Alternatively, it might be used by enemy shuttles landing by (J1.61), presumably to deliver boarding parties, or in the gallant hope of landing on top of the enemy scatter-pack you suspect is being armed.

**(J1.653)** A double-sized shuttle (e.g., a heavy fighter or HTS) could crash land in a shuttle bay, damaging shuttles in two other boxes. A normal-sized shuttle landing on top of part of a double-sized shuttle could cripple it (or destroy a crippled heavy shuttle). The two boxes must be adjacent.

**(J1.654)** A shuttle crippled inside the bay does not drop its weapons as it would in space, but (except for an SP) will drop them immediately upon launch. A suicide, scatter-pack, or wild weasel shuttle armed in the bay which is crippled by another shuttle making a crash landing can still be launched. If arming of an SS or WW was not complete, arming is cancelled. A partially-armed SP could be launched, but arming could not be completed.

**(J1.655)** The presence or absence of warp booster packs has no effect on this rule. Damage points are applied as if there were no WBPs, even if there were.

**(J1.66) LANDING IN DESTROYED BAYS:** Shuttles can land in “destroyed” shuttle boxes of friendly or enemy ships. (After all, the only thing you need is a fairly flat spot in a large open bay.)

**(J1.661)** When a shuttle is in a “destroyed” box, that box can absorb another point of internal damage (which will destroy the shuttle).

**(J1.662)** Shuttles cannot be repaired, rearmed, or prepared for special missions in a “destroyed” shuttle box.

**(J1.663)** A “destroyed” box can be overcrowded (J1.64) or the subject of a crash landing (J1.65).

### (J1.7) RANGE LIMITATIONS

Shuttles are very short-ranged compared to ships, leading to certain limitations.

**(J1.71) DISENGAGEMENT:** Shuttles may disengage by acceleration (C7.13) under limited conditions. Shuttles can disengage by separation (C7.2) or sublight evasion (C7.52). Scenario rules could provide for automatic disengagement under (C7.4).

**(J1.72) SHUTTLES LEFT BEHIND:** Shuttles (including cripples) remaining in play after all friendly ships have been destroyed, captured, or forced to disengage, and shuttles which disengage, are presumed to be destroyed (run out of fuel in deep space) if there is not a planet, base, or ship somewhere relatively close. Because most battles are in the border region (with many bases), and most deep attacks into enemy territory are organized with a “pick up unit” to gather up any retreating fighters (and shuttles, PFs, separated sections, crippled ships, etc.), this is always considered to be the case unless the scenario specifies otherwise.

**(J1.73) BASE REQUIRED:** Shuttles will not normally be the only unit in fleet scenarios because of their range limits. There must be a carrier, base (of some type), or planet with launch/base facilities present for shuttles to be there in the first place. Scenarios such as (SH9.0) are set within a few million miles of a base station. Shuttles are quite limited in their range when compared to starships.

### (J1.8) OTHER SHUTTLE RULES

**(J1.81) CAPTURED SHIPS:** Shuttles on captured ships are considered to be captured, but cannot fire weapons (or be armed as suicide of SP shuttles) during the remainder of the scenario because of coded safety interlocks. They could be used to escape under (D21.0). Shuttles captured in space can be piloted to a friendly ship or base, but cannot fire weapons or use any special equipment and cannot be used for any special mission during the remainder of that scenario. See (D7.541).

**(J1.82) ESCAPE:** If a ship is destroyed or activates self-destruction, each of the shuttles on it (excepting those prepared for use as an SS, SP, or WW) has a chance to escape by (D21.41).

**(J1.83) SELF-DESTRUCT:** Shuttles may self-destruct or surrender just as ships may, should the tactical situation warrant. Under normal circumstances, the situation would only warrant such action if the shuttle were damaged to within two points of destruction or if there were no remaining friendly ships within cruising range. Historically, most shuttle and fighter pilots have chosen to surrender (after destroying their craft) and, with a few notable exceptions, have been treated fairly as prisoners of war. Shuttles that self-destruct or are destroyed do not cause an explosion.

**(J1.84) FIRING AT LAUNCHED SHUTTLES:** A shuttle on the map may be fired at on the impulse of launch by any weapon which follows shuttle launch in the Sequence of Play. Seeking weapons may not be fired at a shuttle on the impulse (or phase in the Cadet Game) in which the shuttle was launched because seeking weapon launch precedes shuttle launch in the Sequence of Play.

**(J1.85) ECONOMIC BPV:** The economic BPV of all shuttlecraft and fighters is equal to one-half of the combat BPV listed on the Master Fighter Chart. When dividing the combat BPV in half, round fractions of 0.50 or more up and fractions of 0.49 or less down. Remember that when buying forces for a Patrol Scenario, you purchase fighters at the higher combat BPV and the enemy, when he damages or destroys them, scores points at the lower Economic BPV.

Exception: SWACs (J9.0) have an Economic BPV of 60.

**(J1.86) UNMANNED SHUTTLES:** In various cases [suicide shuttle (J2.22), scatter-pack (FD7.0), wild weasel (J3.0), and minesweeping shuttles (R1.F2)], a shuttle may be launched without a pilot or crew. In some monster scenarios, it is possible that a manned shuttle may become unmanned, e.g., (SM4.45). A pilot/crew could be transported aboard such a shuttle at a later time as defined in various rules.

**(J1.861)** Scatter-pack shuttles can be boarded under (D7.62). If a friendly SP is boarded in this manner, it becomes inert and the crew can fly it but cannot fire any of its weapons until it has been serviced in a friendly shuttle bay for 32 consecutive impulses. Enemy fighter-SPs cannot be boarded; if a friendly fighter-SP is boarded (only a single pilot can do so), its weapons will not function until it has been

serviced (remained in a friendly hangar bay for 32 consecutive impulses).

**(J1.862)** Enemy wild weasel and suicide shuttles which are still active are boarded under the procedures given in (D7.61) and (D7.62).

**(J1.863)** Friendly wild weasel and suicide shuttles which are still active cannot be boarded.

**(J1.864)** Enemy wild weasel and suicide shuttles which have gone inert or been voided can be boarded under the procedures of (D7.61) and (D7.62) except that capture is automatic; no "booby traps" function [exception (J2.224)]. The shuttle is thereafter treated as a captured shuttle; its weapons cannot be fired and it cannot be used for special missions.

**(J1.865)** Friendly wild weasel and suicide shuttles which have gone inert or been voided can be boarded. The pilot/crew can then pilot the shuttle to a friendly ship or base (or elsewhere) but the weapons will not operate until the shuttle has been serviced (remained in a friendly hangar bay for 32 consecutive impulses). The shuttle can start moving as soon as the pilot is aboard, although this would be a mid-turn speed change (C12.313).

**(J1.866)** Dummy suicide or scatter-pack shuttles are treated as active suicide shuttles if they are still seeking their targets and as inactive ones if they have ceased to do so. Minesweeping shuttles are treated as suicide shuttles for this purpose, but of course will not explode. Exception: A pilot can be transported aboard a minesweeping shuttle.

**(J1.87) TRANSPORTERS** (G8.0) cannot be used to launch or recover shuttles.

**(J2.0) ADMINISTRATIVE SHUTTLES**

Almost all starships in the game have boxes on their SSD sheets marked "shuttle." Each of these boxes holds one administrative shuttle. Some ships in future products (and the Kzinti CV/CVS in Basic Set) have fighters in some of their shuttle boxes. Shuttle boxes designated for fighters have special symbols (= or +) indicating the type of fighter carried; see (J4.0).

There are several other "non-fighter shuttles" in Advanced Missions and other products, including:

- Ground Assault Shuttle (R1.F4)
- Heavy Transport Shuttle (R1.F5)
- Minelaying Shuttle (R1.F6)
- Minesweeping Shuttle (R1.F2)
- Multi-Role Shuttle (J8.0)
- Space Warning and Control Shuttle (J9.0)

These operate within the rules for administrative shuttles except as noted in their individual rules.

**(J2.1) GENERAL**

All administrative shuttles are identical, regardless of the race using them. (This is a generalization for the purpose of simplicity, but within the game the various types of administrative shuttles are operationally identical.)

**(J2.11) SPEED:** All administrative shuttles have a maximum speed of six hexes per turn. This can be increased with warp booster packs (J5.0).

**(J2.12) TURN MODE:** All administrative shuttles have a turn mode of 1 at speeds 1–11 and a turn mode of 2 at speed 12. See (J1.23).

**(J2.13) PHASER:** All administrative shuttles are armed with a single phaser–3 firing in a 360° arc. This phaser is fired like all others (once per turn, no more than once in 8 consecutive impulses on successive turns). The shuttle does not allocate power for the phaser; the design of the shuttle ensures that the phaser will always be charged.

**(J2.14) DAMAGE:** All administrative shuttles are destroyed by the sixth damage point scored against them (or the third damage point if using warp booster packs). They are crippled (J1.33) by four points of damage (two with packs).

**(J2.15) DETECTION OF SPECIAL MISSION:** The fact that a given shuttle is a suicide or SP type is not revealed until it releases its

weapons or reaches its target unless detected by other means listed here.

**(J2.151)** Identification of drones (F1.4) [using labs (G4.2), aegis (D13.0), scouts (G24.25), and other means] can reveal if the shuttle is manned, if it is on a seeking course, and (if so) its target.

**(J2.152)** The fact that a given shuttle is a suicide or SP type is revealed when the shuttle is destroyed. This includes which type (SS or SP) it was, but not the number of drones or the size of the suicide bomb. An unarmed shuttle using (J2.226) or (FD7.45) would be reported as a "normal shuttle."

**(J2.153)** Tactical Intelligence (D17.0) Level M can only reveal if the shuttle is manned; it cannot reveal whether it is carrying a suicide or SP load.

**(J2.16) ARMING:** Most non-fighter shuttles have no weapons that require reloading; those that do (e.g., MRS) use the appropriate reloading rules in (J4.0).

**(J2.17) ELECTRONIC WARFARE:** Non-fighter shuttles do not get the built-in EW that fighters receive under (D6.393) and (D6.394), but they do receive the small target modifiers (E1.7) at appropriate ranges. Scouts cannot lend EW to seeking shuttles (G24.214) but can lend EW to other shuttles. Non-fighter shuttles cannot have EW pods (J4.966).

**(J2.2) MISSIONS**

Administrative shuttles may be used for several missions. A player is required to identify as such an admin shuttle used as a wild weasel, but not one used as a scatter-pack or suicide shuttle. Other procedures such as (J2.15) may require this identification.

**(J2.21) STANDARD** administrative shuttles may be used for transport, surveillance, and combat duties.

**(J2.211)** An administrative shuttle, in its standard configuration, can carry one crew unit (G9.14) or two boarding parties (D7.16). In an emergency situation, it could carry twice this many people for short trips, but would not be able to unload them into a combat situation. For example, a shuttle could be used to rescue four marine boarding parties from a hostile situation, but could only unload them in a safe area, such as a friendly starship or in a remote area as in (D15.7). If unloaded in a combat zone, they could be attacked but could not themselves attack on the turn of unloading.

**(J2.212)** In monster scenarios, an administrative shuttle could be used to gain additional information about the monster. Each administrative shuttle on the map counts as one "lab" box, but at the range of the shuttlecraft, not the range of the ship. The shuttle cannot begin to collect information until eight impulses after launch. The shuttle must be on the map during this entire eight-impulse period. The shuttle can be assumed to have only one pilot and one scientist on board; one crew unit could provide such a team for up to five shuttles, but at least one crew unit must be assigned as shuttle crews for any shuttles to be used. [A legendary science officer (G22.35) can fly the shuttle alone, gaining not only the points for a shuttle but his own under (G22.31).] This can become important when fighting a monster which destroys crew units directly. A shuttle cannot identify seeking weapons (G4.2), but could gather "information points" on non-monster objects in those scenarios where this is a victory condition. A shuttle destroyed or recovered during the turn still gains information points so long as it had become clear of the launch restrictions (J1.343).

**(J2.213)** Administrative shuttles can be used for combat purposes. Each carries a phaser–3 (J2.13) and can be used to provide additional protection from seeking weapons or enemy shuttlecraft. In a close-range ship-to-ship duel, however, they cannot be expected to survive for long. They can fire their phaser once per turn. Each requires a two-man crew (one crew unit to five shuttles).

**(J2.214)** Administrative shuttles have a limited cargo-carrying ability; see (G25.13) and Annex #7K.

**(J2.22) SUICIDE SHUTTLES:** For this use the shuttle is unmanned; the phaser is deactivated, and the power normally used for it is used to maintain the magnetic bottle around the anti-matter warhead. It is loaded with a high yield anti-matter bomb, which has a force of up to 18 damage points should it reach its target. It is otherwise considered to be a seeking weapon (FD1.8) and moves by (F2.0). It has an

endurance sufficient for a scenario. Suicide shuttles count as seeking weapons against the limits of (FD5.3). A suicide shuttle is an armed warhead on launch, and will explode if it enters the hex of its target on the subsequent impulse. There is no delay in the warhead being armed. A crippled suicide shuttle will be slowed, but will not suffer any loss of warhead function.

**(J2.221)** In order to launch a suicide shuttle, the launching ship must arm it.

**(J2.2211)** Arming takes three turns. The ship may expend 1–3 points of warp energy per turn (no less than one, no more than three) in half-point increments (1.0, 1.5, 2.0, 2.5, 3.0). The warhead strength is equal to 2 times the number of energy points applied prior to launch (minimum warhead = 6, maximum = 18), not including any holding energy. If the required energy on the second and third turn is not provided, arming is aborted and previously applied energy is lost.

**(J2.2212)** The third turn of arming can be the turn of launching. If not launched on the third turn, it costs one point of energy (any source) per turn to hold it on board the ship during the fourth and each subsequent turn. If holding energy is not provided, the shuttle is deactivated and all arming energy is lost immediately. The shuttle cannot be launched or prepared for any other mission on that turn. It could be used to escape (D21.41). Additional allocated energy (up to the limit of 9 total points) can be applied to a suicide shuttle being held, but the maximum limit of three points per turn still applies.

**(J2.2213)** Reserve power can be used to begin the arming of a suicide shuttle and can be applied during any of the arming turns (within the limit of three points per turn). Reserve power can also be applied to an armed suicide shuttle being held (up to the limit of 9 total points).

**(J2.222)** Administrative shuttles, minesweeping shuttles (R1.F2), multi-role shuttles (J8.0), SWAC shuttles (J9.0), and minelaying shuttles (R1.F6) can be used as suicide shuttles. Fighters, heavy transport shuttles (R1.F5), and ground assault shuttles (R1.F4) cannot be used as suicide shuttles.

**(J2.223)** The suicide shuttle is destroyed when it reaches its target.

**(J2.224)** If the target of a suicide shuttle is destroyed, the shuttle stops and becomes inert (FD1.72). The booby traps (D7.622) continue to function for purposes of (J1.81), and the bomb remains active (J2.228) unless the controlling ship also cuts tracking (J2.227). If tracking is not cut, the shuttle will proceed to the hex where the target was destroyed and then become inert (unless the target is a WW explosion, in which case the SS will explode).

**(J2.225)** Suicide shuttles cannot be targeted on a plasma torpedo but could be targeted on a drone.

**(J2.226)** Unmanned shuttles can be launched as suicide shuttles without an armed weapon. No energy cost or preparation is required and no time is needed to prepare or unprepare a dummy SS. A shuttle without a bomb stops when it reaches its target and goes inert (FD1.72). An unarmed (dummy) suicide shuttle is treated as an armed (real) one for boarding party purposes. See (FD1.562) when the target is another drone or seeking shuttle.

**(J2.227)** If the controlling ship releases control (F3.4) without transferring it, the shuttle goes inert (FD1.72) and stops; the bomb is ejected safely, and the booby traps are deactivated (so that a pilot can be transported aboard for recovery). The shuttle could be recovered by tractor or by boarding; see (J1.86). Note that a shuttle on a ballistic course (F4.0) cannot be "released" as it is, in a manner of speaking, controlling itself.

**(J2.228)** An active suicide shuttle hauled into a shuttle bay by tractor beam will explode; see (J2.224) and (J2.227). The explosion is applied first to destroy the undestroyed boxes in the shuttle bay and (if the explosion exceeds the size of the bay) is then resolved as internal damage with no phaser directional restriction and no shield or armor effects. It is impossible to haul a friendly active suicide shuttle into the bay as it will go inert when tractored (G7.523).

**(J2.229)** Tholian shuttles can pass through web unhindered (G10.53), making Tholian suicide shuttles (their only seeking weapon) particularly effective.

**(J2.23) WILD WEASELS:** Administrative shuttles can be used as wild weasels, electronic shuttles designed to give the appearance of a ship and distract approaching weapons. Because wild weasels are a very complicated section, they are explained below under a separate rule heading (J3.0).

**(J2.24) SCATTER-PACK SHUTTLES:** Administrative shuttles can be loaded with drones and sent out (under robot pilots) as, in effect, multi-warhead missiles. See (FD7.0) for rules on this procedure.

### (J2.3) SUBLIGHT SHUTTLES

Romulan shuttles before the Klingon Treaty have a speed of one hex per turn. Some Warbirds, Battle Hawks, etc., continued to carry these old style sublight shuttles for years afterwards, until new models were available; see (R4.F0).

### (J3.0) WILD WEASELS (*Advanced*)

In some situations there are so many seeking weapons targeted on a ship that the situation becomes untenable. There are too many to destroy or evade, and they are too close to disengage. In these cases the solution is to equip a shuttle (fighters cannot be used as WWs) with electronic equipment so that it will appear, to the rather limited electronic brains on the seeking weapons, to be the ship. While a wild weasel (WW) is functioning, the ship is limited in its ability to maneuver and fire because this would alert the seeking weapons that they were tracking the wrong target. For this use the shuttle is unmanned and the phaser does not operate (its power is diverted to the WW system). It has no warhead and will not explode. Wild weasels primarily affect seeking weapons (by distracting them), but their EW benefit can affect direct-fire weapons.

### (J3.1) OPERATING CONDITIONS

**(J3.11) WILD WEASEL COURSE AND ACTIVATION:** The shuttle must be launched in a pre-set direction, at any speed up to its maximum speed (including warp booster packs, which can be on or off but which cannot be dropped or turned on/off after launch), and unless a course is designated (J3.111), it will not turn at any time.

**(J3.111)** A WW can be launched on a pre-set course. Up to 96 impulses of directional instructions can be recorded (C1.32); when the end of those instructions is reached, the WW will repeat them. A undestroyed but voided WW will continue to execute this course for the remainder of the scenario, after which it will run out of fuel and become inert (FD1.72).

**(J3.112)** A WW cannot use EM (C10.133).

**(J3.113)** A WW cannot become active while held on board the charging ship; a charged WW must be launched to become active.

**(J3.114)** The wild weasel becomes active immediately on launch. It cannot be launched "tame" and activated later.

**(J3.115)** A crippled shuttle cannot be used as a WW; exception (J1.654). An operating WW on the map continues to function normally if crippled (although possibly at a lower speed).

**(J3.116)** No ship can have more than one active wild weasel on the board at any time. The launching of a second weasel voids a previous weasel at the point of launch. If two are launched at the same time, the owner designates which is first and which is second.

**(J3.12) CHARGING A WILD WEASEL:** To charge a WW, one unit of energy must be allocated on each of two consecutive turns.

**(J3.121)** A WW can be kept in the bay and continuously supplied with energy (one point per turn, i.e., a rolling delay) so that it will be ready on a moment's notice. However, if energy was allocated to a shuttle for use as a WW, the shuttle cannot be used for any other purpose on that turn. If the arming of a shuttle as a WW is cancelled (at the start of a turn) before it was completed, the energy is lost and the shuttle can be launched normally with no delay.

**(J3.122)** A ship can begin charging a WW with reserve power, but cannot use reserve power to arm a wild weasel on subsequent turns and cannot launch a WW less than 32 impulses from the point at which charging was begun.

**(J3.123)** A ship is allowed to have two or more charged or charging WWs in the shuttle bay at any time.

**(J3.13) RESTRICTIONS ON THE LAUNCHING SHIP:** The ship which launched and is protected by the wild weasel, for as long as the wild weasel is on the map and homing weapons are targeted on it, is under the restrictions listed below. Violating the restrictions may void the WW; see (J3.4). In the case of a destroyed WW, see (J3.21).

There are many restrictions in (J3.4) which can void the weasel; the ship must stop performing any of them it is currently performing when (or before) the weasel is launched; e.g., tractors must be released (J3.45). Launching is an overriding factor and can cause the involuntary cessation of many actions and functions outside of the normal Sequence of Play.

See (G10.552) if the ship is in a web hex.

**(J3.131)** The ship may move at a maneuver rate (C2.42) of no more than four. NOTE: It is possible, through a combination of mid-turn speed changes (C12.0), to move five hexes in a given 32 impulse period without voiding the weasel.

**(J3.132)** The ship must deactivate its active fire control system (D6.6). The ship may not fire weapons, even with passive fire control (D19.21). All lock-ons are lost. The ship immediately releases (F3.4) control of all seeking weapons in flight. Control of such weapons can be transferred (F3.5). Previously fired seeking weapons which can obtain (or have) their own guidance and lock-ons do not require the ship to maintain a lock-on and can continue to function without voiding the WW.

**(J3.14) SUBSTITUTE FOR A WILD WEASEL:** A tug could drop a pod (G14.36) and use it in the same manner as a WW. What the pod lacks in electronics, it makes up for in size of target. Some pods are called pallets or packs.

**(J3.141)** Preparing a pod for this purpose requires the same energy and preparation as an actual WW. The pod can use its own systems normally during this preparation period.

**(J3.142)** If the pod survives this use, it could be picked up later by either side.

**(J3.143)** Assuming that the pod is manned and equipped for independent operations and fulfills any other restrictions and requirements, it could move, use any of its own systems (including weapons), and even attempt disengagement (presumably by sublight evasion) or launch a WW of its own.

**(J3.144)** Tug pods, base modules carried as inactive cargo, Tholian cargo (and other) packs, Romulan Freight Eagle pallets, Romulan SkyHawk cargo packs, ISC DPT cargo packs, and other items designated in their descriptions can be used for this purpose.

**(J3.145)** A pseudo-pod (G14.6) cannot be used for this purpose.

**(J3.146)** A base cannot use a docked pod or module for this purpose.

**(J3.15) SUBLIGHT SHUTTLES:** A sublight shuttle such as (R4.F0) can be used as a WW for any ship it is assigned to. Of course, it could not move faster than a speed of one.

**(J3.16) ORIGINAL SHUTTLES ONLY:** All ships can only use their originally assigned shuttles as WWs, not shuttles from other ships or captured enemy shuttles. Bases are under the additional restriction that WWs launched from ships docked to the base will not distract weapons aimed at the base. A WW launched by one of two docked ships (C13.947) would protect both.

**(J3.17) DETECTION:** A wild weasel is immediately detectable as such when launched. A player launching a WW must identify it as such.

**(J3.18) QUALIFIED SHUTTLES:** Any non-fighter shuttle (including MRS, HTS, MLS, MSS, GAS, SWAC, and others) can be used as a WW unless stated otherwise in its description. Fighters cannot be used as WWs (J4.41).

**(J3.2) EFFECT OF A WILD WEASEL**

**(J3.20) GENERAL:** At the instant that a WW is launched, all seeking weapons targeted on the ship begin to follow the WW, not the ship.

Exception: Type-VI drones which have their own lock-ons will ignore a WW; see (FD5.13).

**(J3.201)** All seeking weapons launched with that ship (the one that launched the WW) as a target while an undestroyed and unvoided WW is on the map will not accept the ship as a target, but instead follow the WW. There is also an EW benefit; see (J3.23). A destroyed but unvoided WW will continue to attract newly launched weapons for some time; see (J3.211).

**(J3.202)** Wild weasels protect the ship that launched them and no other. (One exception in a historical scenario of the previous edition

was found to be based on an incorrect translation of source material and has been deleted.)

**(J3.203)** The WW can be targeted in its own right; in this case any seeking weapons would not revert to the protected ship if the weasel was voided. The WW is considered to be a ship of the size of the ship it is protecting for targeting purposes not covered elsewhere (e.g., cannot be targeted by aegis).

**(J3.21) DESTROYED WW:** A wild weasel can be destroyed by one of the seeking weapons homing in on it or by enemy direct-fire weapons. It could also be destroyed by other means, including but not limited to asteroids, planets, or mines. At the instant that the wild weasel is destroyed, turn the counter upside down and record the impulse. The wild weasel ceases to move at that point. A wild weasel is not voided just because it was destroyed. If a wild weasel was destroyed by death-dragging (G7.54), the hex it was occupying when the tractoring unit moved is the destruction hex.

**(J3.211) EXPLOSION PERIOD:** For the remainder of the destruction impulse, and for the four succeeding impulses, the wild weasel is in its "explosion period" when its destruction produces an expanding ball of hot gases. (This is in no way related to an ESG field.) The explosion period lasts from the point in the Impulse Procedure in which the shuttle was destroyed until that same point in the Impulse Procedure four impulses later. Note that this might be from the Damage During Movement Stage to Damage During Movement Stage, or from Direct-Fire Weapons Damage Resolution Stage to Direct-Fire Weapons Damage Resolution Stage, depending on which stage the weasel was destroyed in.

**(J3.2111)** During this explosion period, the wild weasel continues to produce ECM for the launching ship and all seeking weapons following the WW continue to do so. Any additional seeking weapons fired at the protected ship will accept the WW as their target. The ship remains immune to tractoring (J3.452).

**(J3.2112)** During the explosion period, the WW can be voided by the actions of the protected ship. Reactivating the fire control system will not void the WW during the explosion period until the system is fully active (reactivating it before the WW is destroyed would void the WW immediately). Note, however, that the protected ship will require this entire explosion period to reactivate its fire control systems (D6.633). Firing weapons by passive fire control during this period voids the WW; see (D19.21).

**(J3.2113)** The launching of a seeking weapon by the protected ship [even by passive fire control (D19.22)] will void the destroyed WW during the explosion period.

**(J3.2114)** The launching of another WW by the protected ship will void the destroyed WW. Weapons tracking the previous WW will "revert" to the new WW.

**(J3.212) POST-EXPLOSION PERIOD:** After the explosion period, the WW counter remains on the map. During this period the WW is reduced to a pocket of ionized radiation. The post-explosion period continues until all seeking weapons targeted on the WW have reached the explosion hex, accepted other targets, or reached the limit of their endurance.

**(J3.2121)** Any seeking weapons targeted on the WW will continue to move toward it (exploding when they arrive) unless the WW is voided by the protected ship.

**(J3.2122)** Any seeking weapons fired at the protected ship during this period will ignore the WW.

**(J3.2123)** The WW does not generate ECM during this period.

**(J3.2124)** The WW can be voided during this period, in which case weapons still targeted on it will switch to their original target.

**(J3.2125)** Activating fire control will immediately void the weasel (on announcement, before it is fully active) during this period, so the ship might well choose to reactivate the fire control system during the explosion period. See (J3.2112).

**(J3.213) COLLATERAL DAMAGE:** Note that seeking weapons exploding in a WW hex produce collateral damage (J3.3). Note that the WW is hit by the full weapon effect, not just the collateral damage (J3.301).

**(J3.214) CRASH:** If a wild weasel is destroyed by crashing into a small moon or planet without an atmosphere, the weapons following it treat the situation exactly as if the weasel had been destroyed in a space hex.

**(J3.215)** The explosive value of any seeking weapon that hits a wild weasel, even during the post-explosion period, is known, PPTs must

be announced, swordfish drones will fire. Non-exploding drone modules and modifications, e.g., probe module, armor module, ATG guidance, extended range, etc, will not be revealed. Obviously a MW drone tracking a weasel will release its submunitions under its previous targeting instructions.

**(J3.22) VOIDED WW:** A WW will cease to function, and all seeking weapons targeted on it will immediately return to their original target, if it is voided (J3.4).

**(J3.221)** A voided WW is not destroyed merely as a result of this voiding. In such case, the shuttle continues to move as per its original instructions (J3.111) until it is destroyed or recovered by any means. The shuttle can be recovered by tractor (J1.62), or a pilot could be transported aboard; see (J1.86).

**(J3.222)** If recovered by an enemy, a voided WW is worth 10 extra victory points (due to the secret information it contains). If recovered by a friendly ship, it can be reused for other missions after 32 consecutive impulses in the shuttle bay. Note that as a ship can only use its original shuttles as WWs (J3.16) only the ship that originally owned it could use a recovered WW as a WW again. Any ship which recovers a voided WW does not become a WW; the WW does not explode.

**(J3.23) ECM BENEFITS FROM A WW:** If a ship has an unvoided WW on the map, the ship gains the benefit of six points of ECM without expending any energy. Any ECM points from other sources are added to this amount.

**(J3.231)** The six points of ECM are still within the limits given in (D6.392), which restricts a ship from receiving no more than six points of loaned ECM including that from scouts, SWACs, WW, etc.

**(J3.232)** If the WW is destroyed, the ECM benefit continues through the explosion period (J3.2111).

**(J3.24) ACTIVATION:** A WW does not begin functioning until launched. A WW held in the shuttle bay produces no benefits of any type. A WW cannot be held on a balcony (J1.534).

**(J3.25) PULLED INTO BAY:** If pulled inside a ship's shuttle bay, any weapons following the WW accept the ship as their target and the WW is voided. The ship could later use its own WW.

**(J3.26) SIZE CLASS:** Mines treat an unvoided WW as a ship of the size it is simulating, not as a shuttle, for purposes of detection. Mines treat a WW as a shuttle for purposes of damage. ESGs treat a WW as its true size. Note that the wild weasel is not treated in any way as if it were the unit it was launched from for purposes of mine triggering, only as the size class, i.e., weasels launched from minesweepers do not have the benefit of (M2.45).

**(J3.27) TARGET:** Units firing direct-fire weapons at a WW receive the EW penalty for firing at small targets (E1.7) because the firing unit's computers believe the shuttle is a full-size ship and are more likely to miss the small target. The six points of ECM (J3.23) do not protect the WW itself.

**(J3.3) COLLATERAL DAMAGE**

**(J3.30) GENERAL:** Any unit in the same hex as a wild weasel during an impulse when seeking weapons strike the WW (even a previously destroyed WW) is damaged by the effect of the seeking weapons. This is a rare instance where weapons targeted against one unit may damage another unit. Seeking weapons hitting a WW do not actually hit it but are detonated by the electronic field. Their energy is released into space in addition to being scored on the WW, which makes the hex a very dangerous location.

**(J3.301)** The seeking weapons damage the WW just as they would if it were a standard shuttlecraft. Damage to a WW is not resolved as collateral damage. (If a pod is used as a WW substitute, it is treated as a pod, not a shuttle, for damage purposes.)

**(J3.302)** To determine the amount of collateral damage scored on the unit, total the number of damage points scored on the WW and consult the chart below. All damage from seeking weapons that arrive in a given impulse is treated as a single volley.

**(J3.303)** To determine which shield was hit by the collateral damage, roll a die. The die roll result yields the shield number directly. Note, however, that in the case of the ship which launched the WW (when

both the ship and the WW are still in the original hex), the damaged shield is determined by the direction in which the WW was launched (i.e., the direction that the WW is facing). (More advanced rules on actions within a single hex may be published in future and provide alternatives to this random die roll.)

**(J3.304)** Type-VI drones treat a WW (shuttle) as a shuttle, not a ship, and do their normal 8 damage points to the shuttle but produce only 2 damage points for collateral damage purposes. Type-VI drones would treat a WW (pod, pack, pallet, etc.) as a pod.

**(J3.31) WILD WEASEL COLLATERAL DAMAGE CHART**

DAMAGE POINTS ON WILD WEASEL	DAMAGE POINTS ON OTHER UNITS
1-2	0
3-4	1
5-6	2
7-10	3
11-18	4
19-28	5
29-40	6
41-55	7
56-75	8
76-95	9
96+	10

**(J3.4) VOIDING A WILD WEASEL**

**(J3.40) GENERAL:** Violating the restrictions of (J3.13) "voids" the WW immediately. In addition to the restrictions of (J3.13), several activities could result in "voiding" the WW. If the WW is "voided," all weapons following it return to following the original target and the ECM benefits are lost. The voided WW can later be recovered by rule (J3.22) if it is not destroyed first.

**(J3.401)** Activation of the ship's fire control system voids a wild weasel immediately, except in the case of the explosion period (J3.2112), even though the system is not fully active until four impulses later. Many of the items listed below (such as operating an SFG) are impossible without a lock-on, which is the result of active fire control; thus, it is really the active fire control scanners which produce the voiding effect.

**(J3.402)** A destroyed wild weasel can be voided; see (J3.21).

**(J3.403)** In the event a WW is voided, any action taken simultaneously (in the same step) with the voiding act is treated as if the WW is voided. (If a ship protected by a WW fires DF weapons and is, on the same step, struck by DF weapons, it does not have the ECM benefit of the WW.) In addition, see also:

- (C2.42) Maneuver rate when under WW restrictions,
- (D6.65) Activating fire control,
- (D7.61) Voiding by marine boarding parties, and
- (G24.16) Using scout systems

for additional ways to void a WW.

**(J3.404)** Planets might shield a unit committing a voiding action from voiding its WW; see (P2.3224).

**(J3.41) SEEKING WEAPONS:** The launching of a seeking weapon by the same ship during the same Launch Phase (Cadet's Game) as the launching of a WW, or while a WW is operating, constitutes the firing of a weapon and voids the WW.

**(J3.42) RANGE:** If the launching ship is more than 35 hexes from its WW, the WW is void.

**(J3.43) ELECTRONIC WARFARE:** A ship that has launched a WW can use ECM but not ECCM while the WW is operating. As ECCM can only be used with active fire control (D6.622), a ship protected by a WW cannot use ECCM.

**(J3.431)** ECM cannot be lent to a WW by the ship protected by the WW. The WW could receive lent ECM from other units. Any such lending would be conducted under the rules for lending ECM to ships, not to shuttles.

**(J3.432)** The WW could not receive ECM from an EW fighter.

**(J3.433)** The WW does receive ECM from natural sources.

**(J3.434)** An ECM drone protecting the ship launching the WW will follow the WW, but will provide no ECM to it. A ship protected by a

WW cannot become the "protectee" of a new ECM drone. See (FD9.17).

**(J3.435) EW** lent to a ship (except by an ECM drone) which launches a WW can continue but does not protect that ship (D6.3144).

**(J3.44) MINES:** A ship can drop mines from its shuttle bay without voiding its WW. If it uses a transporter to place mines, see (J3.453). A ship cannot detect or sweep mines without voiding the WW.

**(J3.45) PROHIBITED SYSTEMS:** The ship cannot take certain actions or use certain systems.

**(J3.451) A ship** protected by a WW cannot lay, maintain, or reinforce webs without voiding that WW.

**(J3.452) A ship** protected by a WW cannot be tractor (until the end of the explosion period). Pre-existing tractors prevent a WW from being launched. The ship launching the wild weasel must release any of its own tractors before launching the WW (G7.333), or the WW is voided immediately without distracting any weapons or providing any ECM. There is an exception for docked ships; see (C13.947). The ship can use negative tractor without voiding the WW. If, after the explosion period but while seeking weapons are still tracking the destroyed weasel, the ship is tractor and dragged at any speed, the weasel would still not be voided because the protected ship itself has not taken any voiding action. Exceptions: Docked units (C13.947) and tractor bases (G7.90).

**(J3.453) Operating** a transporter voids a WW.

**(J3.454) Launching** a probe (weapon or information) voids a wild weasel.

**(J3.46) EXPANDING SPHERE:** Operating an ESG voids a WW. The WW is voided when the ESG is announced (or voided at launch if an announcement is in effect), not when the ESG becomes active.

**(J3.47) STASIS FIELD GENERATOR:** Operating a stasis field generator voids a WW launched by the operating ship. If a stasis field is applied to the WW by the ship it is protecting, the WW is voided before the field is applied. If the WW is placed in stasis by another ship, see (J3.5).

**(J3.48) ZONES:** A WW is not voided if the protected ship enters or is in a web, atmosphere, special zone, etc. Exception: Nebulae, (P6.4).

**(J3.49) TRACTORS:** A WW is not voided if held by a tractor beam, but like all shuttles can be destroyed if towed at high speed (G7.54) and (J1.212). In that event, destruction of the WW is like any other means of destruction (J3.21); the debris does not continue to move. A ship cannot tractor its own active WW because this would require active fire control, and activating the fire control would void the weasel.

### **(J3.5) HOLDING A WILD WEASEL IN STASIS**

**(J3.51) SUSPENDED FUNCTION:** If a WW is trapped in a stasis field (by other than the launching ship), its functions are suspended immediately and all weapons following it return to following their original target.

**(J3.52) RELEASED FROM STASIS:** When the WW is released from the field, it is treated as if it were launched at the instant of release if it is within six hexes of the originally launching ship (otherwise it is void). If the WW is more than six hexes from the original launching ship at the instant of release, the WW is voided immediately.

**(J3.53) INTERIM PERIOD:** Any activities that would have "voided" the WW which were conducted while the field was operating do not void the WW unless they are continued or repeated after the WW is released.

## **(J4.0) FIGHTERS**

Certain advanced shuttlecraft are used as "fighters" within the game universe. Basic Set presents only one fighter, the Kzinti AAS, which is described in (R5.F2). Many additional fighters appear in Advanced Missions and Module J, and these rules apply to all fighters.

All "fighters" are "shuttles," but not all "shuttles" are "fighters." Note that the authors were VERY careful to define "fighter" and "shuttle" in each case. If a rule refers to "fighters" it does not apply to non-fighter shuttles.

**NOTES:** MRS shuttles (J8.0) and SWAC shuttles (J9.0) are not fighters, but have some aspects of fighters. These are covered in their specific rules. Note also that heavy fighters are treated as fighters except as noted in (J10.0).

### **(J4.1) MOVEMENT**

Fighters have certain advantages in movement over non-fighter shuttles.

**(J4.11) TACTICAL MANEUVERS:** All fighters may make tactical warp maneuvers (C5.43). This is done at speed zero (as with ships). The fighter can make a tactical maneuver whenever its movement is called for [based on the maximum current speed of the fighter (as adjusted for crippled status, booster pack status, and possibly EM status) even though the fighter is not actually moving], but no more often than once in every four impulses. This forms several exceptions to the procedures for ships.

Non-fighter shuttles cannot make tactical maneuvers: exception, MRS and SWAC can make tactical maneuvers.

**(J4.12) HIGH ENERGY TURNS:** All fighters can make one (and only one) high energy turn (C6.0) during each game turn, but cannot make two HETs within 1/4 turn.

**(J4.121) Exception:** Fighters can make an HET to break a tractor beam at any time, regardless of the number of prior HETs; see (G7.55). An HET made for this purpose would count for purposes of the required delay between HETs.

**(J4.122) There is no energy or movement cost for an HET.**

**(J4.123) Fighters never roll for breakdown.**

**(J4.13) EMERGENCY DECELERATION:** Fighters may use emergency deceleration (C8.0), but gain no shield benefit. They may begin tactical maneuvers (J4.11) after two impulses. See also (J1.223).

### **(J4.2) FIGHTER-LAUNCHED SEEKING WEAPONS**

Fighters often carry drones and plasma torpedoes.

**(J4.21) LAUNCHING SEEKING WEAPONS:** All fighters must have their target in their FA firing arc to have a lock-on for purposes of launching seeking weapons. The facing of the fighter has no effect on its ability to control seeking weapons it has launched; the target can be in any arc. A shuttle armed with an ADD rack can launch type-VI drones from that rack in any direction within the restrictions of (E5.41), but such a launch counts against the maximum number of seeking weapons the shuttle can launch under (J4.24).

**(J4.22) SEEKING WEAPON GUIDANCE:** Any friendly unit can (within its own limits) assume guidance control of any of the seeking weapons launched by friendly fighters; see (FD5.33). All units are limited in their ability to control seeking weapons (F3.2) and cannot exceed this limit. The ship could release (F3.4) the guidance of one or more seeking weapons to accept control of others.

**(J4.221) TRANSFER OF CONTROL:** A normal fighter cannot accept transfer (F3.5) of control of a seeking weapon from another unit. An EW fighter (R1.F7) or two-seat fighter (J4.43) can accept such transfers, but only from fighters in their own squadron (J4.46). MRS (J8.0) and SWAC (J9.0) shuttles also can accept transfers of control from any unit. Heavy fighters (J10.44) can accept transfers of control. Tholian and Hydran heavy fighters cannot control seeking weapons.



**(J4.222) EARLY KZINTI FIGHTERS:** When Kzinti fighters first appeared, they did not have their own guidance equipment. These were known as attack shuttles (AS) found in (R5.F1), the prototypes of the advanced attack shuttles (R5.F2) shown in the game. This condition applies only during the historical period Y161-Y163. During this period, the carrier (or another unit, e.g., an MRS) must immediately assume guidance duties for any drone launched by one of its shuttles. There are no two-seat or EW versions of the AS fighter.

**(J4.23) DRONE LAUNCH RAILS:** Fighters carry drones on launch rails. There are four basic types of rails. In Basic Set, the only fighter (the Kzinti AS/AAS) has two "standard rails;" the remainder of this section can be ignored.

**(J4.231)** The "standard rail" can carry one type-I drone.

**(J4.2311)** Players may freely substitute type-VI drones on these rails (one type-VI replaces one type-I); there is no BPV change for doing so (although speed cost upgrades will be less expensive).

**(J4.2312)** EW pods can be carried on standard drone rails, but cannot be carried on other types of rails.

**(J4.2313)** Standard rails cannot carry multi-warhead drones, but can carry other special types noted in (FD10.0).

**(J4.2314)** Standard rails cannot carry type-D plasma torpedoes.

**(J4.232)** Many fighters have "small rails" or "light rails" that can only carry a single type-VI drone. The C-refit (R1.F8) converted many of these "small rails" to "standard rails" late in the war.

**(J4.233)** The "special rail" is used on only a few fighters, such as the F-14A. It can carry type-I or type-III drones, including multi-warhead and other special drones. Each such rail increases the BPV of the original fighter by 1 point (e.g., the F-14A costs 2 points more than the standard F-14). Note that this rail can also be fitted with a type-VI drone.

**(J4.234)** A very few fighters have "heavy" rails able to carry type-IV drones. These rails can also carry type-VI, type-I, or type-III (one drone per rail, regardless of size). These can be special or multi-warhead drones.

**(J4.235)** The types of rails on a given fighter are shown on the Master Fighter Chart (Annex #4) in terms of the drone types carried.

**(J4.24) DRONE FIRING RATES:** A fighter can always launch one drone per turn (assuming it has at least one drone), but cannot launch two drones on consecutive turns within 1/4 turn (8 impulses) of each other.

**(J4.241)** Unless otherwise stated in the rules, any fighter can launch two drones per turn (or within 1/4 turn) if:

A-both are launched at the same target; and

B-one (or both) of them is a dogfight (type-VI) drone.

Some exemptions to the A and B restrictions are listed in (J4.242) below. No fighter can exceed the per-turn rate within a 1/4-turn period (of two consecutive turns).

**(J4.242)** Exceptions include the F-14 (which can ignore restriction B; type-IIIs also have their own special rules), the F-15 and TAAS (which can violate A if the drones are not launched on the same impulse, and which can violate B in any case), the Z-Y (which can violate both), heavy fighters (J10.4), and others as may be noted in the rulebook. The A-10 is covered under (J10.43).

**(J4.25) DRONE CONTROL:** Any fighter can control a number of drones equal to the number of non-DFDs (non-dogfight drones, i.e., drones other than type-VI) in its nominal load exclusive of variants, if any (or two drones, whichever is greater). Note that type-VI drones must be guided until they achieve their own lock-on (FD5.12).

**EXAMPLE:** An F-15 nominally carries 4 type-I and 4 type-VI drones, so it can control 4 drones, even if some type-I are replaced by type-VI and even if it is an F-15C (R1.F8) built after Y183 with 6 type-I drones.

**(J4.26) DRONE TYPES:** Fighters can carry any of the special types of drones in Advanced Missions or other products, except those specifically prohibited in their individual rules. Note that most drone launch rails (J4.23) cannot carry multi-warhead drones.

**(J4.27) TYPE-F PLASMA TORPEDOES** are subject to all of the above restrictions although, since standard fighters can only carry one and since plasma torpedoes are self-guiding, this is greatly simplified.

**(J4.28) TYPE-D PLASMA TORPEDOES** are generally treated as type-I drones for purposes of the above rules although, because they are self-guiding, the procedures are simplified. Type-D plasmas use a unique type of launch rail which cannot carry drones.

### (J4.3) FIGHTER LAUNCH RESTRICTIONS AND LANDING CONDITIONS

**(J4.31) SEEKING WEAPONS:** Fighters carrying seeking weapons may not launch them immediately after they are themselves launched. See (J1.341).

**(J4.32) DIRECT-FIRE WEAPONS:** Fighters may not fire direct-fire weapons immediately after launch; see (J1.342).

**(J4.33) OTHER SYSTEMS:** Those systems which a fighter cannot use immediately after launch are listed in (J1.343).

**(J4.34) LANDING:** Fighters land by the procedures in (J1.6). Fighters do not have to eject or discharge their weapons before landing on a ship which has fighter facilities for that type of weapon.

Exceptions: Surrendered fighters (J7.73) must eject or discharge all weapons. Fighters crash-landing on an enemy ship (without permission of that ship) do not have to eject or discharge their weapons (J1.63).

### (J4.4) ADDITIONAL RULES ON FIGHTERS

**(J4.41) INELIGIBLE MISSIONS:** Fighters may not be used for suicide missions (J2.22) or scientific research (J2.212). Exceptions may be provided in later products.

Fighters can never be used as wild weasels (J3.18).

Fighters may be used as scatter-packs (FD7.44).

**(J4.42) BOARDING:** Fighters may not be boarded by boarding parties (D7.0).

Exception: Fighters inside your shuttle bay (G7.8).

**(J4.43) TWO-SEAT FIGHTERS:** There is a two-seat version of all fighter types. Each carrier can have one such fighter; CVAs can have two. The two-seat version costs 2 points (combat BPV) more than the standard version, but has the same performance. In addition, it can control up to 12 seeking weapons and can assume control of such weapons launched by other fighters of its squadron.

Two-seat fighters are often modified into EW fighters; see (R1.F7). EW fighters retain the seeking weapon control ability of two-seat fighters.

**(J4.44) PHASERS:** Fighters can fire each of their phasers once per turn (gattling phasers, of course, fire four times per turn). The energy to rearm the phaser is drawn from the fighter's engine; it is not recharged by the carrier.

**(J4.45) HEAVY WEAPONS** are recharged by the ship in "fighter facilities" (holding cells in each fighter box of the shuttle bay) and transferred to the fighter by deck crews. See (J4.8).

Heavy weapons are fired under the same rules as ship-mounted weapons of the respective type. Thus, a Federation A-10 fighter cannot fire its photon at range 0-1, and a Klingon Z-D cannot fire its disruptor at range 0.

**(J4.46) SQUADRON ORGANIZATION:** Players may organize fighter squadrons before the scenario begins within these rules.

**(J4.461)** All of the fighters in the squadron must be from the same carrier. The carrier must organize its fighters into the minimum number of squadrons.

**(J4.462)** No more than 12 fighters can be included in the squadron. A heavy fighter counts as two fighters for this purpose.

**(J4.463)** No more than one EWF can be included in the squadron. Squadrons with fewer than eight fighters cannot include an EWF, but the carrier might have an MRS (J8.51).

**(J4.464)** One (and no more than one) MRS or SWAC shuttle from the same carrier can be added to the squadron. This shuttle can accept control of seeking weapons and provide EW support. This shuttle does not benefit from EW points it is loaning to the squadron and

does not benefit from EW points loaned to the squadron by the carrier.

**(J4.465)** Squadrons may be reorganized during a scenario so long as all of the above rules are adhered to and so long as any fighter being transferred between two squadrons is on board the carrier for one full turn. Changing the software in a fighter (to change its squadron) takes one deck crew action.

**(J4.466)** Fighters from one carrier landed on another carrier of the same race, so long as they are a type that is operated by the carrier on which they landed, can be incorporated into a squadron within these rules. Note, however, that this does not at any time apply to MRS shuttles which can only be attuned to another ship between scenarios.

Exception: The Lyrans use unmodified Klingon fighters. These can freely transfer so long as the transferring fighter is of a specific type operated by the receiving carrier.

**(J4.47) BUILT-IN EW POINTS:** All fighters have two points of built-in ECM (D6.394) and two points of built-in ECCM (D6.393).

**(J4.48) FIGHTER CLASSES:** For purposes of various rules, fighters are often grouped into "classes" based on BPV as follows:  
 Class 1 Fighters.....0-7 BPV points.  
 Class 2 Fighters.....8-10 BPV points.  
 Class 3 Fighters.....11-15 BPV points.  
 Class 4 Fighters.....16 or more BPV points.

The cost includes drone speed upgrades and the cost of "special drone rails;" the cost does not include pilot quality (J6.0).

**(J4.49) DROPPING WEAPONS:** Any shuttle may, at any time, drop (discard, discharge) any of its rail-mounted weapons (including chaff, pods, drones, plasma-Ds).

**(J4.5) CLOSE COMBAT MANEUVERING**

**(J4.51) AGAINST SHUTTLES:** Fighters may always fire (or launch seeking weapons) at any other shuttle that is in the same hex as they are regardless of relative facing. This reflects "close combat maneuvering." (This assumes that the fighter is otherwise able to fire/launch the weapon in question.) This rule is used only against shuttles. It is a simpler alternative to the dogfighting rules in (J7.0). Obviously, both rules cannot be used in the same scenario.

**(J4.52) AGAINST SHIPS:** A fighter may use "close combat maneuvering" in a hex to position itself to fire upon an enemy ship from an advantageous position.

**(J4.521)** To use CCM against a ship, the fighter must already be in the same hex as the ship as a result of movement on previous impulses. CCM cannot be used if the ship entered the hex on the current impulse. Because of the Sequence of Play, CCM cannot be used if the fighter entered the hex on the current impulse (as its movement would already be complete and no HET would be possible).

**(J4.522)** The fighter executes an HET within the limits of (J4.12) and announces that it is using CCM relative to a given enemy ship in the hex; it does not leave the hex even if scheduled to move. The fighter is then turned to its new facing and is deemed to have moved around the ship and turned to position the ship on its forward centerline. The fighter is then facing the appropriate shield and is in the corresponding weapon arcs of the target. A fighter using CCM is maneuvering so violently through the hex that any ship in the hex can fire any weapon at the fighter regardless of firing arcs.

**(J4.523) EXAMPLE:** A Kzinti AAS is in the same hex as the Klingon F5 at the start of the impulse. The F5 is facing in direction A. Based on (D3.42), the fighter is facing the #1 shield of the F5. The #3 shield of the F5 is down from a previous attack, and the fighter wishes to engage this shield. The fighter executes an HET to face in direction F. It is now facing the F5's #3 shield, and the fighter is in the R and RR firing arcs of the F5.

**(J4.6) CARRIER OPERATIONS**

**(J4.61) CARRIERS:** Most fighters are carried by specially designed ships (carriers) or operate from bases. It should be noted that most fighter types can theoretically be carried by most ships, but they are usually restricted to special carriers. This is because of the need for

administrative shuttles on starships (for utility and other missions) and the lack of special fighter maintenance facilities on most starships.

Players should be aware that the deployment restrictions observed by the various fleets are for a reason, and that even though this reason is outside the scope of the game, it should not be ignored. Ships going on dangerous special purpose missions might, however, be loaded with fighters instead of some, but not all, of their regular shuttles. (This can only happen in a published scenario. It cannot be done in a patrol scenario without permission of all players.) During earlier times (1942), for example, Army bombers were launched from a Navy carrier. But it was only done once, and for a very special mission, and the Navy carrier could not operate her own aircraft in her own defense while carrying the bombers.

**(J4.62) CASUAL CARRIERS:** Some ships have ready racks for fighters, and may even carry one or two, but are not "carriers" within the context of the rules. These ships are known as "casual carriers". Examples include most carrier escorts, the Hydran Pegasus and Gendarme, and many WYN ships.

**(J4.621)** Casual carriers have enough drones and chaff pods to rearm those fighters (or a number of fighters equal to their ready racks) three times. Special drones can be purchased as Commander's Option Items at normal racial percentages (FD10.6). Drones in the racks are slow unless speed upgrades are paid for. Pay the cost of speed upgrades for one loading of the ready racks (FD2.45); the rest are held in "fighter storage" as per (FD2.443). See (J4.75) for other supplies. The fighters on the carrier will determine what type of ready racks are on the escort, and this will in turn determine the numbers of drones held in the racks.

Federation carrier escorts (R2.R5) have their drones stored in cargo boxes, not in "fighter storage," and have special drones proportional to those on their carrier.

**(J4.622)** Casual carriers cannot loan EW points to their fighters as true carriers can.

**(J4.623)** Most Hydran ships carry at least some fighters; any Hydran ship carrying fighters is considered to be an "fully-capable" carrier unless specifically noted otherwise in its ship description. Carrier tugs and monitors equipped with fighter or SCS pallets are fully-capable carriers. There is some confusion between Star Fleet Battles and the companion strategic game "Federation & Empire." F&E uses the term "true carrier" to refer to ships which carry full fighter squadrons, causing confusion because the term "true carrier" was sometimes used in SFB for what is now called a "fully capable" carrier.

**(J4.7) SUPPLIES FOR FIGHTERS**

Carriers that operate fighters carrying drones are presumed to have a supply of drones on board. These drones are used to rearm the ship's fighters. The Kzinti CV has 150 "spaces" of spare drones for its fighters. The drone storage capacity of other carriers (in other products) is shown in Annex #7G (in Module J or Advanced Missions). The drone loadouts are purchased under the requirements and limitations of (FD2.45), (J4.23), and (FD10.6); extra drones can be purchased under (S3.2) to increase the pool of available drones. The supplies listed here are included in the BPV of the carrier and do not have to be purchased separately.

**(J4.71) STORED DRONES:** Stored drones (including those in the ready racks) are kept inert by having their detonators removed. They will not explode and do not increase the strength of the ship's final explosion.

**(J4.72) READY RACKS:** Drones held in ready racks (J4.89) or loaded on the fighters count as part of the ship's storage under Annex #7G (or others). Drones in ready racks will not explode or constitute an armed fighter for chain reaction purposes (D12.0). Drones on a fighter will not contribute to the explosion, but do make the fighter vulnerable to chain reactions.

**(J4.73) TORPEDO RELOADS:** Federation ships have a "photon freezer" to supply photon torpedoes for their A-10 attack shuttles; Romulan, ISC, and Gorn ships have stasis boxes to store extra plasma-F torpedoes. Hydran ships have facilities to store charges for fusion beams and hellbores. These are within and part of the various shuttle (fighter) boxes on the SSD and are explained in (J4.8).

**(J4.74) REPAIR:** Fighters can be repaired, but not rearmed, if landed in a shuttle box without ready racks. See (J4.897) for a partial exception and (J4.898) for another exception.

**(J4.75) SUPPLIES:** Carriers have various types of expendable supplies for their fighters. See (J4.621) for supplies carried by escorts and casual carriers. These supplies are in the same (D16.0) area as the shuttle bay.

**(J4.751)** A carrier is presumed to carry enough chaff pods (D11.2) to reload each of its fighters three times.

**(J4.752)** A fully-capable carrier has two EW pods for each of its fighters although most of these will probably be used by the two-seat EW fighter.

**(J4.753)** See (J5.42) for data on warp booster pack storage.

**(J4.754)** Extra supplies can be purchased as Commander's Options (S3.2).

### **(J4.8) REARMING FIGHTERS**

Fighters may return to their carrier (or any friendly ship with appropriate facilities) during the course of a scenario to pick up more drones (or other weapons), chaff packs, or EW pods or to be repaired. Any ship can recover a fighter, but only one with "appropriate facilities" can service that fighter. Various rules, such as (J4.8962) and (J4.895), allow most ships to provide at least some services. A fighter would never begin a scenario on a ship it is not usually based on except during a campaign. Special scenario rules might define some circumstances where fighters are someplace other than a designated carrier.

**NOTE:** As Basic Set includes only drone-armed fighters, only rules (J4.81), (J4.82), (J4.88), and (J4.89) need be read at this time. If you add products which include other types of fighters to your personal game system, the relevant reload rules will be found below. Inclusion of these rules in Basic Set will allow you to use the fighters in any one of several expansion products (e.g., Advanced Missions, Module C1, Module C2, or Module J) without owning any of the others.

**(J4.81) DECK CREWS:** All carriers (of any race) have a number of "deck crews" equal to the number of fighters carried. (Some ships are designated to have a different number.)

**(J4.811)** Deck crews are killed when the shuttle/fighter box they are working in is destroyed. If several deck crews are working in that box, all are killed. Determine the number of deck crews functioning at the start of each turn; these are considered to function throughout that turn unless killed or involved in a transfer to another bay.

**(J4.812)** When evacuating a ship, deck crews can be ignored since they are counted as part of the regular crew units. If transferred specifically as such, two deck crews are equal to one crew unit.

**(J4.813)** Deck crews are assigned to a specific shuttle bay and can work on any shuttle within that bay. Each deck crew is assigned to a specific shuttle box at all times, unless they are being transferred. Deck crews transferred between two bays are unavailable for use on the turn that the transfer is made. Deck crews can be transferred indefinitely (even if there is only one bay) to avoid having them assigned to a shuttle box.

**(J4.814)** All ships not formally assigned a number of deck crews by Annex #7G are assumed to have two deck crews. These can be used for loading scatter-packs, repairing shuttles, changing modular pallets on multi-role PFS, etc. Carrier escorts (with ready racks but without fighters) and casual carriers have one deck crew per ready rack (minimum two deck crews). These deck crews cannot be transferred to another ship. If transferred as a crew unit (e.g., during an evacuation) they do not retain their abilities as a deck crew.

**(J4.815)** If a ship buys an MRS (J8.0) as a Commander's Option (S3.2), it comes with one deck crew in addition to any assigned by Annex #7G. If the ship is not assigned deck crews, the two deck crews provided by (J4.814) handle the MRS and no additional deck crew is included with the MRS.

**(J4.816)** Additional deck crews can be purchased under (S3.2).

**(J4.817)** Deck crew activities are expressed in terms of "deck crew actions" (also known as "deck crew activities" or "deck crew operations"), each being the equivalent of the work done by one deck crew for one entire turn.

**(J4.8171)** Each deck crew action takes 32 consecutive impulses. A half action, to reload a type-VI drone for example,

takes 16 impulses. An action can begin on any impulse (subject to other rules).

**(J4.8172)** Loading cannot commence until the impulse after the fighter enters the bay; the fighter cannot launch until the impulse after reloading is complete (unless the deck crew is interrupted). A fighter could land during Impulse #10 of Turn #2, be reloaded (by two deck crews) with two type-I drones, and launch on Impulse #11 of Turn #3. No more than 2 deck crews can work on one fighter or shuttle (rearming or repairing it) [exception: (J10.112)], and one deck crew cannot work on two or more fighters. Two more deck crews can load the ready rack in that box if there is space available on the rack. The rack cannot be simultaneously loaded by one set of deck crews and provide drones for other deck crews to load on the fighter, even if this is done in different positions on the rack. See (J4.823).

**(J4.8173)** The relationship between an "action" and a particular type of ordnance is defined within the various rules below.

**(J4.8174)** Deck crew actions can be interrupted by various means. (The fighter could launch, the player could transfer the deck crew at the end of the turn, damage could destroy the shuttle and/or the shuttle box, the deck crew could be killed, etc.) If the action is interrupted, it is cancelled and the fighter is in the same condition as if the action had never been started.

**(J4.8175)** All deck crew actions must be recorded, specifically noting which fighter/shuttle deck crew actions were performed on and the turn/impulses the activity was performed [including (J4.818) actions]. This record must be presented to the opposing player for review at the end of the scenario.

**(J4.818)** A deck crew can repair one point of damage to a shuttle as one deck crew action.

**(J4.82) REARMING PROCEDURE, DRONES:** Drones are physical objects which must be removed from storage, uncrated, fully assembled, placed on a ready rack (J4.89), and then loaded on a shuttle.

**(J4.821)** Deck crew operations are linked to the space points of the drone being acted upon. A one-space drone requires one deck crew operation. A two-space (e.g., type-IV) drone requires two actions. A half-space (e.g., ADD or type-VI) requires one-half of a deck crew action. [i.e., A deck crew loads a type-VI drone in half the time it takes to load a type-I drone.] Moving a drone from storage (FD2.44) to a ready rack is one action (per space). Loading a drone from a ready rack onto a fighter is one action per drone space.

**(J4.822)** Each shuttle box that originally contained a fighter that can carry drones is presumed to have a "ready rack" to store reloads. This is a mechanical assembly that could be considered a cross between a gun rack and a forklift.

**(J4.8221)** The drones are loaded onto the rack, which then lifts the drones into position so that they can be loaded on the fighter. Fighters cannot have drones reloaded unless these drones are already stored in the ready rack; exception: (J4.896).

**(J4.8222)** Each ready rack holds the same drones that the fighter it is designed to service carries. Each ready rack is designed for a specific type of fighter. See (J4.891).

**(J4.8223)** Normally, a carrier keeps the ready racks filled but the fighters unloaded. When a strike is needed, the fighters are loaded with drones and launched. The deck crews then reload the racks while the fighters are on their mission so that the fighters can be reloaded quickly when they return.

**(J4.8224)** The status of a given carrier's fighters is shown by the weapons status (S4.0). At WS-III the fighters are loaded but their weapons were taken from the ready racks, which have not been refilled.

**(J4.8225)** Variants of fighters (e.g., C-refit, F-18B) can be rearmed in each other's ready racks, but obviously cannot load a weapon for which they are not authorized. If, for example, a fighter without a C-refit was in a fighter box for a fighter with a C-refit, and the ready rack held a type-I drone in a position that corresponded to a type-VI drone rail, that drone could not be loaded. Type-Is could be loaded by (J4.8962).

**(J4.823)** Each deck crew operation takes 32 consecutive impulses; see (J4.8171). An operation can begin on any impulse, but crews can only be transferred at the end of the turn. This provides flexibility to drone-armed fighters as one deck crew could start reloading a fighter on a given impulse and then be joined at the end of the turn by a second crew. For example, a fighter lands on Impulse #16. One deck crew is there waiting and starts loading a type-I drone on Impulse

#17. At the end of the turn, a second deck crew joins them and the loading of that drone is then completed on Impulse #8.

(J4.824) Drone storage is specified in (FD2.443).

(J4.825) The rearming and storage rules for drones are used for type-D plasma torpedoes, with the exception that type-Ds require activation energy (FP9.22). A type-D torpedo is the same size as a one-space drone.

No fighter in the game can use both type-D plasmas and drones, so you cannot load drones on a plasma-D-armed fighter (nor vice versa). It would be theoretically possible to transfer type-D plasmas to a drone-armed carrier (G25.3) and then load them on type-D-armed fighters using the deck crews and drone handling equipment. No carrier (or any other ship) can begin a scenario with both drones and type-D torpedoes on board. (There could be a possible exception in the case of an Orion ship with mixed technology.) The drones (on a plasma carrier) and plasma-Ds (on a drone carrier) would be loaded by (J4.8962) not by the ready racks.

(J4.83) **REARMING PROCEDURE, HYDRAN SHIPS:** The Hydrans operate two types of fighters, those with fusion beams and those with hellbores. See (J4.88) and (J4.89).

(J4.831) Each fusion fighter box on a Hydran ship (marked with an =) has a capacitor able to hold up to eight fusion charges. These capacitors are destroyed with the fighter box. Since most of their fighters take two charges in each of two weapons, each fighter box holds up to two complete reloads. At WS-III, a fusion capacitor would still be holding one charge, the other being on the fighter.

(J4.832) The capacitors can be recharged (1 point per charge, 8 points of energy to fill the capacitor) from the ship's power.

(J4.833) The fighters are reloaded from the capacitors in the same procedure as drones, with each charge being loaded counting as 1/2 of a deck crew operation. The capacitors in a given fighter box can only be loaded on the fighter in that box.

(J4.834) Some Hydran fighters carry hellbores. The fighter boxes for these fighters (marked with a +) have one capacitor for a hellbore charge (part of the fighter box, in place of the fusion capacitor); reloading the fighter with this charge is a single deck crew action. The capacitor in a given box can only reload the fighter in that box. The charge can be reloaded (for 2 points of power on each of two consecutive turns) by the ship.

(J4.835) Some Hydran ships have both types of fighters. Fighters can only reload in the appropriate type of box. See also (J4.895), (J4.896), and (J4.897). The reference to (J4.896) is valid, but this can happen only in cases where a drone-armed fighter lands on a foreign carrier during a battle.

(J4.84) **REARMING PROCEDURE, DISRUPTOR-ARMED FIGHTERS:** See (J4.88) and (J4.89).

(J4.841) The Klingons, Kzintis, Lyrans, and Tholians operate disruptor-armed fighters. These are rearmed by this procedure. The fighters cannot rearm the disruptors themselves.

(J4.842) Each disruptor-armed fighter is based in a shuttle box (marked +); that shuttle box is equipped with a capacitor (not shown on the SSD) for two disruptor charges. Other shuttle boxes on the ship do not have these capacitors. The ship loads the capacitors (2 points per charge; both points must be provided on the same turn).

(J4.843) Reloading a disruptor charge on a fighter is a single deck crew action.

(J4.844) Disruptor-armed fighters are fairly uncommon in Klingon and Kzinti service. CVAs might carry a flight of six as part of a mixed squadron. This restriction does not apply to heavy fighters, which were themselves fairly uncommon. Note: The Klingons usually relied on Z-1 and Z-P fighters for the heavy attack mission, in addition to Z-Ds.

(J4.845) All disruptor-armed fighters (except as noted) can hold two charges for each disruptor. These are loaded individually as above.

(J4.85) **REARMING PROCEDURE, PHOTON-ARMED FIGHTERS:** See (J4.88) and (J4.89).

(J4.851) The Federation operates the A-10 and A-20 shuttles, both of which carry photon torpedoes. These are rearmed by this procedure. The fighters cannot rearm the photon torpedoes themselves.

(J4.852) Each fighter box assigned to a photon-armed fighter (marked +) includes a capacitor for a single photon torpedo. This capacitor can be reloaded (same procedure as a photon torpedo tube, 2 points of warp power for 2 consecutive turns, but overloads are not allowed) by the ship's power. A torpedo loaded in the storage

facility may be loaded on a photon-armed fighter by deck crews. The torpedoes cannot be fired from the storage facilities in the shuttle bay.

(J4.853) Reloading a shuttle with a photon torpedo is a single deck crew action.

(J4.854) The torpedo can be set as a standard or proximity fuse at the time the charge is loaded on the fighter. Changing this afterwards requires a deck crew action.

(J4.86) **REARMING PROCEDURE, TYPE-F PLASMA TORPEDOES:** See (J4.88) and (J4.89).

(J4.861) Many Romulan, Gorn, and ISC fighters carry type-F plasma torpedoes. These are rearmed by this procedure; the fighters cannot rearm plasma torpedoes themselves.

(J4.862) Each shuttle box (marked +) that carries a fighter capable of firing a type-F plasma torpedo includes a storage facility (not shown on the SSD) for a single type-F plasma torpedo. Boxes holding fighters that do not carry this weapon do not have the storage facility. (For example, the SparrowHawk-B has eight shuttle boxes in each module, four of which are equipped with these storage facilities. Thus, four of the SpH-Bs boxes are marked + and four are marked = for plasma-D fighters.)

(J4.863) Reloading a type-F plasma torpedo on a fighter is a single deck crew action.

(J4.864) No fighter can fire a plasma bolt (FP8.23).

(J4.865) No fighter has pseudo plasma torpedoes (FP6.14).

**NOTE:** Plasma-Ds use the drone procedure; see (J4.82).

(J4.87) **RELOADING PROCEDURE, ANTI-DRONES/RALADS**

Anti-drones (E5.0) and RALADS (J12.0) are reloaded using the same procedure as drones (J4.82). Each ADD/RALAD is equivalent to a 1/2-space drone.

(J4.88) **GENERAL REARMING PROCEDURES:** The following general rules are in effect unless otherwise specified.

(J4.881) The ship can rearm the weapons' storage capacitors (freezers). The cost of arming a weapon to be held for later use by a fighter, and the reloading procedure, is the same as arming the same weapon on the ship. [Exception: Hydrans (J4.832).] For example, there is no difference whatsoever in arming the type-F plasma torpedo on a ship than in arming one to be held for use by a fighter.

(J4.882) The weapons can be loaded on fighters on the turn when they are charged. The fighter does not pay an energy cost to hold the charged weapon. The ship cannot reload the fighter directly, but must reload the storage capacitor.

(J4.883) Weapons stored in fighter boxes cannot be fired from those boxes or transferred to the ship's weapons. (Exception: Drones and plasma-Ds can be removed from a shuttle bay for use on the ship's drone racks and vice versa.) They can be ejected into space. [The fact that a weapon was ejected from the fighter facilities is known at Tactical Intelligence Level B.] They do not explode in chain reactions (D12.0). No holding cost is paid for charges (for energy-based weapons) held in a fighter-capacitor.

(J4.884) The ship can recharge any or all of its fighter weapon storage facilities at the same time.

(J4.885) No fighter can use, and no storage facility can hold, an overloaded weapon.

(J4.886) Unless otherwise specified [e.g., (D18.0) or (D17.75)], it is assumed that all freezers, storage facilities, capacitors, and ready racks (in shuttle boxes) are fully loaded at the start of a scenario but the fighters are not. Any fighters armed at the start of a scenario are presumed to have drawn from these freezers, which cannot be recharged before the scenario begins.

This rule explains and restricts the terms for arming fighters in WS-III. The conditions include and apply to drone and ADD racks on shuttles. See (J4.8224).

(J4.887) None of these storage facilities/ready racks appear on the SSD (except as the + and = marks in shuttle boxes). They are assumed to be part of the shuttle box and are destroyed by damage points scored on those shuttle boxes. If a shuttle box is destroyed, the reload facilities and any weapons loaded in them are lost. If repaired, the reload facility is unloaded.

(J4.89) **READY RACKS:** The variously described ready racks (J4.822) and storage boxes (J4.88) can be included in the general term "ready rack" or "fighter facility" or "weapons charge storage facility" or "capacitor" for purposes of these rules. Some carriers have

two or more kinds of fighter facilities; this requires additional restrictions.

**(J4.891)** Each specific fighter type has its own specific ready rack. A fighter can receive repairs, but not weapons, in a shuttle box or in a box with the wrong kind of ready rack [except as noted, e.g., (J4.896) or (J10.11)].

**(J4.892)** Energy weapons can be reloaded from a shuttle box of the same race with facilities for that specific weapon, but the required number of deck crew actions are doubled, but a plasma-F torpedo cannot be reloaded in a plasma-D or photon shuttle box.

**(J4.893)** Players might choose to standardize the types of fighters on their carrier to reduce their workload and simplify the game.

**(J4.8931)** On many Hydran SSDs, some fighter boxes are shown with hellbore (+) reload facilities while others show fusion (=) facilities. The player can freely replace the Stinger-H fighters (and reload facilities) with Stinger-1 or -2, but cannot add more Stinger-H fighters.

**(J4.8932)** On most Romulan and ISC, and some Gorn carriers, some fighter boxes are marked for fighters with plasma-F (+) while others are marked for fighters with plasma-D (=). These show the standard deployments. In non-historical modifications, players can replace plasma-F fighters with the others, but not vice-versa. Also note that plasma-D fighters are reloaded in boxes with the drone symbol, but these ready racks cannot load plasma-D torpedoes on drone-armed fighters.

**(J4.8933)** Disruptor-fighter boxes (+) can be replaced with drone-fighter boxes (=), but not vice-versa.

**(J4.8934)** Federation A-10s can be replaced with F-18s, but not with other types (such as F-14s or F-15s).

**(J4.894)** If an MRS shuttle is carried, it has its own unique ready rack (storage capacitor, or whatever). The MRS and its rack are treated as a different type of fighter for purposes of reloading from non-standard ready racks.

**(J4.895)** Any fighter box can load chaff on any fighter so equipped or repair damage on any shuttle.

**(J4.896)** Drones are fairly standard, and while it may be difficult to manhandle a drone out of a Federation F-18 ready rack and load it on a Kzinti AAS fighter, it can be done.

**(J4.8961)** Any fighter box for a drone-armed fighter can reload drones on any friendly drone-armed fighter, but cannot load more than one drone (regardless of size) per turn on a fighter that is not of the type for which the rack was designed. Note, however, that the carrier might not have the correct special drones for the fighter; standard explosive drones (of the proper size) will of course fit any drone-armed fighter.

**(J4.8962)** Any shuttle box without a ready rack holding drones can still load one drone on a fighter. However, because the drone must be carried to the box (by overhead crane, a service cart, or the Kzinti weightlifting team), it takes twice as many deck crew actions as would normally be required. This could be done by a ship which had no fighters or ready racks, but which had drones on board. The drone must be brought to the bay (a deck crew action) before this procedure can begin. See (J4.899) in the case of a different size of fighter. Drones on ready racks in other shuttle boxes of the same bay count as already being in the bay.

**(J4.8963)** The same procedure can be used with plasma-Ds although, of course, drones and plasma-Ds are not interchangeable on fighters. Arming energy can be applied to plasma-Ds in non-plasma-D shuttle boxes.

**(J4.897)** Many carrier escorts (and some other ships) have ready racks and deck crews, but have no fighters; see (J4.62). These racks are used to reload fighters from carriers within that fleet. The player designates each rack as to its type before the scenario/campaign begins. These racks cannot include disruptor, hellbore, or plasma-F fighter types. These "casual carriers" have supplies for fighters defined in (J4.62), based on the number of racks (as they have no actual fighters). See (R2.R5) for Federation escorts.

**(J4.898)** Electronic warfare fighters can be serviced with repairs, chaff, and EW pods in any fighter reload box. If the EWF carries weapons, these can only be reloaded from an appropriate reload box for a basic fighter of that type. Alternatively, see (J4.896).

Electronic warfare pods can be added to any fighters in any fighter box (assuming other restrictions are met) or in a non-fighter box using (J4.8962).

**(J4.899)** Heavy fighters and standard fighters cannot use each other's ready racks. Fighters in the wrong "size" shuttle box could,

however, be serviced as in: (J4.891) repairs, (J4.892) energy weapons (but only when a standard-sized fighter is in one of a pair of heavy fighter boxes and the other box is empty), (J4.8962) drones (taking three deck crew operations per drone, EW pods and type-D plasma are treated the same way), or (J4.895) chaff.

### **(J4.9) FIGHTER ELECTRONIC WARFARE** *Commander's Level Rule*

Fighters use special electronic warfare rules to reflect their differences from ships. If you are not using the Commander's Level EW rules, you can ignore all of (J4.9). Some aspects of this rule apply to non-fighter shuttles. Non-fighter shuttles can be lent EW by a scout channel.

*The fighter electronic warfare rules were written by Felix Hack.*

**(J4.91) MAXIMUM EW LEVELS:** A given fighter cannot use more than six points of ECM or more than six points of ECCM, including its built-in points (J4.47), points from EWFs (J4.96), and points received by lending from other units (J4.92), but not including ECM points from "natural sources." Note that this is six points each of ECM and ECCM, not six total points. See (D6.3143) for natural sources. Non-fighter shuttles can only receive natural EW and EW lent via a scout channel.

**(J4.92) RECEIVING LENT EW:** While a fighter has some built-in EW points, this is seldom enough to compete in the electronic warfare arena. While a fighter could receive lent EW from a scout under (G24.217), there will be far too many fighters in place for the scout to support each one as an individual. Instead, fighters are grouped into squadrons (J4.46) and the squadron is lent EW as a whole by the rules below.

**(J4.921)** Any fighter that has a lock-on to and is within either three hexes of an crippled EWF (or MRS, or SWAC shuttle) from its squadron, or which is within ten hexes of its specific home carrier (or base), can receive "loaned" ECM and ECCM from that source.

**(J4.922)** A given fighter can only receive "lent" EW points from a single outside source. It can change the source it is receiving from every 8 impulses. It cannot change just because the present source became unavailable but would have to continue "receiving" from that unit (even though it could not use the points). A fighter can begin receiving points immediately after launch, see (J1.343). Non-fighter shuttles can receive lending from scouts.

**(J4.923)** A crippled shuttle can receive lent EW (J1.333).

**(J4.93) LENDING EW TO SQUADRONS:** A given carrier, EWF, MRS, or SWAC can loan the points it is generating to all fighters (of a designated squadron) that are within the appropriate distance and otherwise qualify. Each of the fighters receives all of the loaned points from the loaning unit. See (C10.523).

**EXAMPLE:** Four F-18 fighters are on a mission. Fighter #1 is an EWF version carrying four EWFs, #2 has two EWFs, #3 and #4 have no EWFs. Assuming that each EWF generates one point of ECM and one of ECCM, fighter #1 will have six points each of ECM and ECCM (two built-in and four from the pods), #2 will have eight points of each (two built-in, two from its own pods, and four from #1), while #3 and #4 will have six points of each (two built-in and four from #1). If the carrier were within 10 hexes and generating four points of ECM and two points of ECCM for lending (its maximum), it could loan those points to the fighters, but any fighter receiving the points couldn't benefit from the points from the EWF since a fighter can only receive lent points from a single source (J4.922).

Note that fighter #2 has eight points of ECM and ECCM, but can only use six of each. If, for some reason, it lost two of each of its points, it would still have six of each.

Note further that the carrier could generate any combination of ECM/ECCM (to a total of six) for its own use, independently of what it is generating to be lent to fighters.

**(J4.931)** The electronic warfare points lent by a carrier are generated in a special manner (under an equal limit) separately from those points generated by the carrier for its own use. The same points cannot be used by both the carrier and the fighters. Only actual carriers (not casual carriers) can use this procedure; see (J4.6). EW generated for a squadron which is accepting EW from another source (J4.921) can be detected.

**(J4.932)** A carrier cannot re-lend points it has received from another source, whether natural (EM, asteroids, etc.) or from a scout, SWAC, or MRS.

**(J4.933)** A carrier with more than 12 fighters could divide them into squadrons (J4.46) and generate a separate set of EW points for each group (assuming it has the power). This division into squadrons (J4.462) is not strictly required, but if the fighters are not grouped into squadrons, the squadron EW lending rule cannot be used.

**(J4.934)** An MRS or SWAC shuttle cannot simultaneously lend points to its squadron and its carrier.

**EXAMPLE:** A carrier has launched a fighter squadron and an MRS. The carrier could provide EW points to the fighters while the MRS provides EW points to the carrier, or the MRS could provide EW to the fighters (if it was officially assigned to their squadron). In the latter case, the carrier could not provide EW support to the fighters (which can receive EW from only a single source) and the carrier cannot provide EW support to the MRS (because the MRS is not a fighter and cannot receive carrier-lent EW), see (J8.43).

**(J4.935)** A crippled shuttle cannot lend EW (J1.333).

**(J4.94) MAXIMUM EW SUPPORT:** Each type of unit that can lend EW has a specific limit.

**(J4.941)** An EW fighter could have up to four EW pods and could lend up to eight EW points (combined total of ECM and ECCM).

**(J4.942)** A carrier cannot lend more points to any given squadron than its sensor rating.

**(J4.943)** An MRS can lend the points provided in (J8.43).

**(J4.944)** A SWAC can lend the points provided in (J9.14).

**(J4.95) FIGHTER IN DOGFIGHT:** A fighter involved in a dogfight (J7.0) cannot receive EW points from outside sources during the time it is in the dogfight. If it is receiving such points when the dogfight begins, the lending unit may continue to lend them (without effect) so that they would be effective as soon as the dogfight is over. If a fighter in a dogfight is not currently receiving EW points, a friendly unit can begin lending them to the fighter (without effect) so that they will become effective as soon as the dogfight is over. All of this lending is, of course, done within the appropriate rules.

Fighters using (J4.5) can receive lending.

**(J4.96) ELECTRONIC WARFARE PODS:** All fighters have a built-in capability for electronic warfare; see (J4.47). To increase this capability, fighters began using electronic warfare pods (EWPs) in Y168. EWPs are often carried on special electronic warfare fighters (EWF); see (R1.F7) and (J4.43).

**NOTE:** This entire rule (J4.96) is replaced by (J11.2) in Module J, incorporating various advanced rules and capabilities.

**(J4.961)** Each EWP can provide two points of either ECM or ECCM, or one of each. This is determined secretly and simultaneously (B2.4) and announced in the Sensor Lock-On Phase of each turn.

**(J4.962)** Each EWP is loaded by a deck crew as a single deck crew action (the same as loading a one-space drone). An EWP replaces one drone carried by the fighter. EWPs that replace drones do not affect fighter speed or performance although they will of course reduce its offensive armament.

**(J4.9621)** Fighters may carry extra EWPs (without reducing the number of drones carried), but for each extra one carried (to a maximum of two), reduce the speed (with or without warp packs) and the dogfight rating (J7.62) of the fighter by one.

**(J4.9622)** A fighter can drop an "extra" EWP carried under (J4.9621) to improve its speed and DFR, but the pod cannot be recovered. The speed and DFR improve immediately; this does not count as a speed change or acceleration for delay purposes. The EWP can be dropped at the point before seeking weapons could be launched, but the EW situation must be rebalanced immediately.

**(J4.963)** Extra EWPs beyond those provided in (J4.752) can be purchased as Commander's Options (S3.2).

**(J4.964)** No fighter can carry more than two EWPs; exception EWFs (R1.F7) or heavy fighters (J10.0) can have four (including any built-in). Regardless of how many EWPs are carried, the maximum EW a fighter can use is as per (J4.91).

**(J4.965)** The EW points generated by EWPs on an EWF are used by the EWF in addition to its built-in EW (J4.47). Only those points generated by the EWPs, and not the built-in points, can be lent to the other fighters in the squadron. An EW fighter doing EM can use its EWPs for itself.

**(J4.966)** MRS, SWAC, and other non-fighter shuttles cannot carry EWPs.

**(J4.967)** A fighter can turn off its EWPs during any Lock-On Stage of the Impulse Activity Segment.

### SYNOPSIS OF RULES IN STAR FLEET BATTLES CAPTAIN'S MODULE J

To aid in later integration of Basic Set with a whole range of advanced and expansion products, the Basic Set rules are filled with numerous cross-references to the rules from those other products. Of course, if you do not have a given product, then any rules from that product cannot be used; they do not impose any penalties or provide any benefits to the player. To aid in understanding the Basic Set rules, and to prevent confusion over these references to rules in other products, the following synopsis of these rules is provided.

**(J5.0) WARP BOOST PACKS:** These became available later in the General War. While they double the speed of a fighter, they make it more vulnerable to damage.

**(J6.0) PILOT QUALITY:** Pilots can be rated as Good, Ace, or Green. Ace pilots have various advantages, while Green pilots (with less experience) are under various penalties.

**(J7.0) DOGFIGHTING:** Fighters can engage other fighters directly in short-range combat. This is done not merely to destroy the enemy fighters, but also to tie them up and prevent them from attacking the ships.

**(J8.0) MULTI-ROLE SHUTTLES:** These special shuttles are available to carriers, command ships, and some larger warships and can perform a variety of functions, including electronic warfare, seeking weapons control, minelaying, etc.

**(J9.0) FEDERATION SWAC SHUTTLES:** The most powerful electronic warfare shuttle in the game, the SWAC can only be used by the Federation and is carried only by its largest carriers. SWACs have massive electronic warfare capabilities, not the least of which is their ability to "go wild" and attract all seeking weapons.

**(J10.0) HEAVY FIGHTERS:** The last and most powerful of the fighters, these are twice the size of standard shuttles and fighters (taking two shuttle boxes on the carrier).

**(J11.0) FIGHTER PODS:** Various additional systems can be added to fighters to improve performance or for special missions.

**(J12.0) RALADS:** This system allows anti-drones to be fired from special drone rails as a direct-fire system.

**(J13.0) CASUAL BASES:** Virtually any flat spot on a planet can become a fighter base; this rule provides the required data.

### END OF SECTION (J0.0) BASIC SET

**(M0.0) MINE WARFARE****(M1.0) GENERAL RULES**

Mines are special devices laid in space which usually contain both a control mechanism and a warhead (which is usually explosive). They are used not only for a variety of defensive and deterrent purposes but also have some value as offensive weapons.

The SFB CAPTAIN'S BASIC SET includes a rudimentary section on space mines. This includes the large mines carried by certain older Romulan ships (M2.0) and the smaller "transporter bombs" carried by most ships (M3.0).

ADVANCED MISSIONS includes a much more extensive section on mine warfare, including various types of mines, minefields, and minesweeping, designated (M4.0) through (M9.0). Note that "detecting" a mine is not the same as causing it to explode. Mine detection is covered in Advanced Missions.

**(M2.0) NUCLEAR SPACE MINES:  
BASIC MINE TRIGGERING RULES**

Mines are explosive packages equipped with sensors and programmed to explode when they detect a moving ship or other unit. This rule section provides the basic mechanics for all mines.

(M2.0) also deals specifically with "large" mines which are known as "nuclear space mines" or NSMs. Within the game, the terms "large mine" and "NSM" are interchangeable. "Small mines" (M3.0) are just as nuclear as large mines and are placed in space just as large mines are, but the term "NSM" is reserved only for large mines. Both of these mines are subcategories of automatic-explosive mines as defined in Advanced Missions rules (M4.3) and (M5.1), the mechanics of which are described in this section.

Romulan Old Series ships (e.g., Warbird and War Eagle in Basic Set) each carry one nuclear space mine (NSM) which they can use in attempts to damage or destroy enemy units. In Advanced Missions, minelayers will be provided which can lay extensive fields of large mines.

**(M2.1) LAYING**

Mines can be dropped in the same hex as the (laying) ship without dropping a shield. When dropped, the mine is placed in the same hex as the unit that dropped it (at the time it was dropped). Minelayers use special rules for laying mines; see (M9.0).

If using plotted movement, the action of laying a mine, including the specific impulse and hex, must be plotted in advance. If using the standard free movement rules, plotting is not required. See (C1.33) for restricted mine placement at some levels of plotting. See (M2.6) for secret placement.

**(M2.11) LAYING RATE:** A ship can drop one mine (regardless of size) from each of its shuttle bays [not boxes; see (J1.51) for definition of bays] each turn, with no two bombs being dropped from a given bay within 1/4 turn. Units using erratic maneuvers cannot lay mines; see (C10.53).

**(M2.111)** Mines cannot be dropped on the same impulse that a shuttle is launched or landed through the main shuttle hatch (J1.502), or on the impulse before or after such an impulse. (In effect, the dropping of a mine replaces the launching of a shuttle.) Mines are dropped through the main hatch only; not through the launch tubes.

**(M2.112)** Mines can be dropped even if all shuttle boxes in that bay have been destroyed.

**(M2.113)** See Annex #7M or #7G for how many bays each ship has; this data is also noted on the SSDs. A shuttle bay which contains only fighters cannot be used to drop mines. See, for example, (R9.R2).

Shuttle bays in the booms of Klingon ships cannot lay T-bombs unless the boom is detached *and* the boom is specified by (G12.8) as carrying T-bombs. Shuttle bays with two hatches could drop one mine from each hatch each turn, even on the same impulse.

**(M2.114)** Mines can be dropped even if the ship is being held in a tractor beam; see (G7.945).

**(M2.115)** Large mines cannot be laid by transporter; see (M3.225).

**(M2.12) PLACEMENT:** A mine counter is placed in the hex where a mine is laid. Exception: the dropping of a mine from a ship cannot be detected if using (M2.6).

**(M2.13) EXCEPTIONS:** Certain ships have exceptions to the mine laying rate given in (M2.11).

**(M2.131)** Andromedan ships, which do not have shuttle bays, drop T-bombs out of a special hatch. See (R10.1D42). This hatch is considered a shuttle bay for this purpose (only).

**(M2.132)** PF Leaders, which have no shuttle bay, drop their single T-bomb from an external rack. See (K4.3). Minelaying PFs operate as per (M9.21).

**(M2.133)** Ships with special mine racks, such as minesweepers and minelayers, use the faster rate in (M9.21).

**(M2.134)** Some types of mines in Advanced Missions (M9.23) cannot be laid during a scenario. No mines of these types are included in Basic Set.

**(M2.14) TARGET SIZE SELECTION:** Players have some control over what targets the mine will accept.

**(M2.141)** At the point of laying a mine, the player laying it secretly records in writing the size classes (R0.6) that it will accept as a target; it will ignore all other size classes. (If no classes are specified, it will accept all size classes.) For example, this allows a mine to be set to ignore drones but accept ships, thereby preventing the enemy from clearing the mines without risk by detonating them with drones. See (M5.15) for more details.

**(M2.142)** A mine could also be given no size-class settings, in which case it would remain inert (i.e., would not explode) except under certain conditions such as: contact with an ESG (G23.61), a failed minesweeping attempt (M8.4), etc. The player cannot exclude any of these conditions.

**(M2.143)** An unvoided wild weasel will be regarded by a mine as a ship of the size it is simulating; see (J3.26).

**(M2.144)** The sizes set need not be continuous. For example, a setting of 1-3 and 5-7 is acceptable, as is a setting of 2+4+7.

**(M2.15) TARGET COUNT DELAY:** At the point of laying a mine, the player laying it may record instructions to ignore the first 1-6 targets (his choice how many). This number is the total number of targets acceptable under (M2.14) regardless of the size class of individual targets. See (M5.16).

**(M2.151)** This is a total number of targets, not the total number of die roll opportunities. If one target leaves the detection zone and later returns and reenters the detection zone, it counts as a second target.

**(M2.152)** The mine will automatically reset this count to zero between scenarios.

**(M2.153)** If the potential target is moving slowly and is not detected, it is not counted toward the delay. Once such a target is detected (and ignored), it will continue to be ignored so long as it remains in the detection zone.

**(M2.154)** If multiple targets enter the detection zone of a mine with a delay, place them in order as per (M2.47) and resolve the situation by the rules above.

**(M2.2) CONDITIONS**

**(M2.21) IMMOVABLE OBJECT:** Once dropped, the mine cannot be picked up, disarmed, or moved by any means, including tractor beams (G7.271), transporters (G8.341), or displacement devices (G18.72). [Exception: Black Holes (P4.14) can move a mine.] Mines cannot be placed in orbit (P8.472).

**(M2.22) DESTRUCTION:** The mine cannot be destroyed or damaged, unless it:

- detonates against an acceptable target (M2.4),
- falls into a black hole (P4.21),
- is struck by an ESG (G23.61),
- is placed in a nebula (P6.6),
- or unless it is swept by (M8.0).

Mines are immune to many effects including:

- Radiation Zones (P15.2),
- Gravity Waves (P9.315),
- Pulsar Outbursts (P5.23).

**(M2.23) NEUTRALITY:** Once dropped, the mine is neutral in all respects. It will trigger against any unit, including the one that dropped it or a unit on the same side as the one that dropped it. Mines cannot be set to accept only enemy units. A mine that could distinguish between enemy and friendly units would be much more expensive and could possibly be fooled (not to mention needing continuous updating due to changes in ship design and shifting alliances), rendering minefields worthless. Therefore, none were ever built.

### (M2.3) ARMING

Before the mine can trigger, it must be armed.

**(M2.31) POINT OF ARMING:** Arming takes place automatically at the instant that the unit which dropped the mine leaves the mine's Detection Range (M2.35).

For purposes of Basic Set, the ship must move away from the mine by two hexes. (That is, the ship is no longer in the same hex as the mine or in a hex adjacent to the mine.) Displacing (G18.0) out of the detection zone is also leaving.

Transporter bombs placed by transporter have a delay before they will arm; see (M3.223).

**(M2.32) DESTROYED MINELAYER:** If the laying unit is destroyed or displaced (G18.0), it is no longer within the safety range and the mine becomes armed at that point.

**(M2.33) SIZE SETTING:** The mine cannot become active until the laying unit leaves the area specified, even if the mine is set for a size target that does not include the laying unit.

**(M2.34) SEQUENCE:** The mine cannot become active until the end of the Movement Step on the impulse on which the laying unit moved out of the detection range. Thus, a unit which entered the detection range on the same impulse, regardless of the movement order specified in (C1.313), could not trigger the mine on that impulse. However, since the mine is now armed, any subsequent movement in the detection zone could detonate it. See (C13.19) for additional information.

**(M2.35) DETECTION RANGE:** All mines have a detection range, the range at which they can detect a moving object. All hexes within this range are in the detection zone of that particular mine. All mines in Basic Set have a detection range of 1 (and hence a detection zone of 7 hexes, the mine hex and the six surrounding hexes). Detection range is always in terms of "true range" (D1.4), never effective range.

### (M2.4) DETONATION; TRIGGERING

**(M2.40) PROCEDURE:** If any unit acceptable to the mine's instructions (M2.14) moves into a hex of the detection zone (M2.35) of an armed mine, there is a chance that the mine will trigger. To determine this, roll a single die. If the result is less than the unit's effective speed (C2.451), the mine has triggered. If the result is greater than or equal to the unit's speed, the mine has been detected in time and avoided; it does not trigger on that impulse. It might trigger as a result of later movement by this or another unit. Movement of the mine itself [black hole (P4.14)] will not cause the mine to trigger, only movement of a valid target.

Exceptions: Cloaked ships (G13.55) and minesweepers (M2.45). Ships entering a detection zone while using Erratic Maneuvers (C10.46) will always trigger mines. Either nimbleness or cloaking may protect a slow ship from detonating every mine.

**(M2.41) TRIGGERING:** The possibility of a mine triggering is resolved when the unit *enters* a hex in the detection zone of an active mine. While an anti-drone is, technically, a physical object, the passage of an anti-drone round through the detection range of a mine will not detonate the mine.

**NOTE:** While the mines in Basic Set simply explode, some of the mines in Advanced Missions perform other actions when triggered. For purposes of Basic Set, the terms "triggering" and "detonating" are identical.

**(M2.411)** Should the mine become active while a unit is in its detection zone, the unit will not trigger the mine on that impulse. Only entering a hex in the detection zone will cause the mine to trigger.

**(M2.412)** A unit moving in the vicinity of a mine may enter several hexes within the detection zone (and may enter the mine hex itself) and must roll for possible triggering each impulse that it enters a hex inside the detection zone.

**(M2.413)** The key factor is "entering a hex within the detection zone." Even if moving away from the mine at the time, entering a hex in the detection zone of a mine qualifies for a die roll to see if the mine has triggered. This example uses a detection radius of 1 hex.

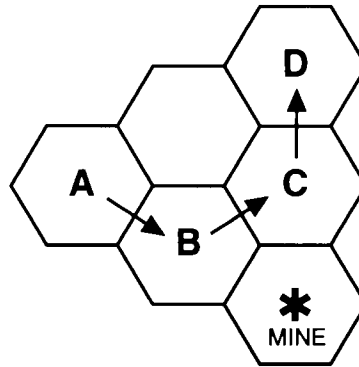

Movement from A to B or from B to C might trigger the mine, but movement from C to D could not.

**(M2.414)** Expending movement points without moving (e.g., tactical maneuvers, high energy turns, while trapped in web) cannot trigger a mine; see (C2.45). Base rotation (C3.7) will not trigger a mine, but a base in orbit (P8.2) could "move" into a mine's detection zone and possibly trigger it (it is moving at a speed of one). Erratic maneuvers do count as movement; see (C2.45), (M2.43), and (C10.46). Moving without expending movement points (e.g., pulled by a black hole) can trigger a mine (C2.451).

**(M2.415)** Being rotated by tractor (G7.7) into detection range does not trigger a mine immediately, but the rotated unit is treated as having entered that hex at its current effective speed on Impulse #1. Shuttles being rotated by (J1.62) are treated as entering the hex at the current effective speed of the rotating ship.

**(M2.416)** A unit displaced into a hex in the detection zone of a mine does not trigger the mine by its arrival; see (G18.65). Further movement may trigger the mine. Appearing in such a hex by displacement and then moving into a hex which is outside of the detection zone will not trigger the mine. Appearing by transporter (G19.41) will not, in itself, trigger a mine.

**(M2.417)** Some mines in Advanced Missions have the capability to damage targets several hexes away. In such case, the detection zone (M2.35) is considerably larger, and a ship moving through that larger detection zone will have many more opportunities to trigger the mine. See (M5.12).

**(M2.418)** In the event that a drone (or seeking shuttle) enters the hex of its target, and that hex is within the detection zone of a mine, the Sequence of Play (Annex #2) defines that the drone will strike its target *and then* the mine will trigger.

**(M2.419)** Electronic warfare (D6.3) never affects triggering.

**(M2.42) DIE ROLL OF 1:** A die roll result of "1" always results in the triggering of an active mine, regardless of the speed of the triggering unit.



**(M2.43) MOVEMENT TRIGGER:** Only movement into a hex within a detection zone can cause triggering; see (M2.41). Leaving such a hex, appearing in such a hex by displacement device (M2.416), or performing a tactical maneuver or high energy turn (M2.414) in such a hex will not cause triggering. Impulses in which a moving unit does not actually move (i.e., change hexes) do not require a die roll, unless the unit is conducting erratic maneuvers (C10.46).

**(M2.44) MULTIPLE MINES:** Whenever a given movement action (i.e., a unit entering a hex) has the possibility of triggering several different mines, roll separately for each mine. See the example in (M2.47).

**(M2.441)** Each unit can only cause one mine to trigger for each hex of its movement, even if several mines are in the same or adjacent hexes. Once one mine has been triggered by one moving unit, that same unit cannot trigger any other mines on that impulse. See (M2.443) below.

Exceptions: Chain (M5.3), Deadman (M5.35), and ESG impact (G23.61).

**(M2.442)** If more than one mine is available, determine the order in which they will be rolled for randomly before rolling for any one mine. Obviously, a mine that will not accept a given target will not be rolled for, and this may reveal some data about its targeting instructions.

**(M2.443)** Mines which are not automatically controlled (M5.1) do not count against this limit. All of the mines in Basic Set (NSMs and transporter bombs) are automatically controlled and therefore do count against this limit. If you only have Basic Set, you can ignore (M2.443).

When they are not relying on their automatic triggers, command (M5.2) and chain (M5.3) controlled mines do not count against this limit; see Advanced Missions. Command-controlled mines (M5.2) are never included in this limit as the unit controlling them can detonate any or all of them as the situation requires.

Sensor mines (M4.5) and captor mines (M4.4) are treated separately. If one or more of each type are in position, group them into categories (sensor, explosive, captor), put the members of each category into a random order, and roll for each mine in each category until one mine in that group triggers or all mines in that category have been rolled for.

**(M2.444)** While mines can be rigged (in Advanced Missions) to trigger each other or might be triggered simultaneously by various means, each mine is a separate explosion. They are not combined together [see, for example (G10.76)], and each is resolved as a separate volley (M2.502).

**(M2.45) MINESWEEPERS** (which are in Advanced Missions) add two to their die roll in (M2.40), lowering the chance of triggering the mine, but rule (M2.42) still applies. Cloaked minesweepers do not receive this benefit. See (XM2.45).

**(M2.46) RANGE:** Explosive mines will not trigger if their target is not within their blast range, which is one hex. See (M5.12).

Exception: Chain (M5.3) or Deadman (M5.35).

**(M2.47) MULTIPLE UNITS:** Cases may arise where two or more units are in a relatively small area with two or more mines. In as much as the movement of a single unit can only cause the triggering of a single mine, this can become complicated. See (M2.44). The procedure is as follows:

A. For each unit, determine which mines it could trigger.

B. Place these mines (for each unit) in a random order by rolling a die for each mine and placing the mines in order from the highest to lowest. (Roll again to resolve ties.)

C. Roll for the possible triggering of each mine in order until one mine triggers or all mines have failed to. Repeat this procedure for each unit.

If one unit triggers a given mine, do not delete this mine from other lists. It is possible that two units could trigger the same mine. In the event that two or more acceptable targets trigger the same mine and the mine is NOT of the explosive type (Advanced Missions), the mine will direct its actions against the target which is closest. If the targets are equally close, roll a die to determine which target the mine directs itself against.

### EXAMPLE OF MULTIPLE MINE INTERACTIONS

The operative rule is (M2.441), which states that the movement of one unit can only cause the detonation of one mine. Let's say that we have two mines in hex 3407 and one in hex 3508. A ship is in 3309 and enters 3408, while at the same time a drone (perhaps targeted on the ship) is in 3405 and enters 3406.

The ship is adjacent to all three mines and could detonate any of them. (M2.442) says that you roll in a random order. (M2.47) says that when two units are in a small area, you determine the order for each moving unit by die roll. For the ship, we do this and find that 3508 is first. For sake of argument, we will say that it did not explode (the ship is moving at speed 4; at speeds of 7 or more the die roll would have been automatic). The next mines are those in 3407. We roll for the first one, and it explodes. Because the ship has caused one mine to explode, it does not roll for any further mines.

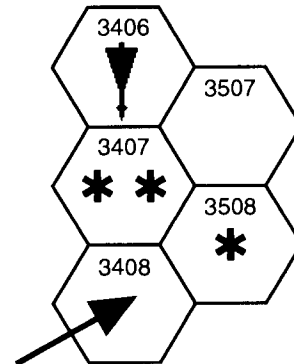

The drone must now roll for mine explosions. It has only the 2 mines in 3407 to deal with. While one of them has just exploded, movement is simultaneous so, at the time the drone rolls, that mine has not exploded and must be rolled for.

We determine the order for these mines randomly under rule (M2.47), and note that the unexploded #2 mine in that hex is first for the drone. Due to the drone speed, explosion is automatic. So, in this case, the drone and the ship each set off different mines in the same hex; both take full damage from each. Having set off one mine, the drone does not "roll" for the second.

**(M2.48) PLASMA TORPEDOES** will not trigger mines; exception type-D (phaser armed) captor mines in (M4.41) and sensor mines (M4.5) controlling phaser-captors.

Mines (with the exception of phaser captors) cannot damage plasma torpedoes and will not accept them as targets. It is possible that other mines could be added to the game which will also affect plasma torpedoes; if so, those mines will be noted in their own rules.

**(M2.5) RESOLVING EXPLOSIONS**

**(M2.50) PROCEDURE:** If a mine explodes, it will damage all units in the same hex as the mine and all units in hexes adjacent to the mine. This is known as the explosion zone.

A mine explosion is not entirely the same as a ship explosion (D5.0).

**(M2.501)** A large explosive mine causes 35 points of damage to the shield facing the mine hex. If the unit is in the mine hex, the mine is presumed to damage the shield which was facing the mine hex when the unit entered that hex. This will usually be the #1 shield (#4 if moving in reverse), but see (M2.53) for a possible exception. **EXCEPTIONS:** Atmosphere (P2.5471), ESGs (G23.61), webs (G10.76), object of damage in stasis (G16.41).

If a mine is placed in a hex occupied by a unit which is not moving (or moving slowly) and detonates (due to some other factor) before the unit in question leaves the hex, the shield facing the mine is the shield facing the hexside through which the unit which dropped the mine (D3.43) entered the hex. This might be a different shield than the one that was facing that hexside when the mine was dropped if the ship performed tactical maneuvers or an HET in intervening impulses between the mine being dropped, arming, and triggering.

**(M2.502)** Each mine explosion is resolved as a separate volley.

**(M2.51) DAMAGE ALL UNITS:** If a mine explodes, it will damage all objects within the explosion zone, even if some of them are "friendly" to the mine, and even if those friendly objects are not the ones that caused the mine to explode; see (M2.54).

**(M2.52) UNMOVING UNITS:** Units which are not moving [and thus could not set off the mine; see (M2.43)] are still damaged if they are in the explosion zone (M2.50) when the mine explodes.

**(M2.53) SIDESLIP:** If a unit sideslips (C4.0) into a hex containing a mine and sets off that mine, the shield facing the hex entered takes the damage, not the #1 (or #4) shield.

**(M2.54) OTHER MINES:** An exploding mine will not destroy, damage, or trigger other mines within the range of its blast. Exception: (M5.31).

**(M2.55) PLASMA TORPEDOES:** The explosion of explosive mines will not damage a plasma torpedo.

**(M2.6) SECRET PLACEMENT (Optional)**

This optional procedure can be used by the players to add extra excitement, suspense, and tension to the game. It is often used in scenarios for mines placed before the scenario begins. It will require a certain amount of trust, fair play, and record keeping, and in highly competitive games may require a neutral referee to keep track of where the mines are.

This procedure cannot be used for mines which were laid by transporter (M3.222).

**(M2.61) PROCEDURE:** When a mine is dropped, the player dropping the mine records the hex number that it was dropped in, as well as the ship that dropped it and the turn and impulse number. He does not place a counter in that hex. The player must also record the settings of (M2.14) and (M2.15).

The opposing player should keep track of enemy movement to verify that the ship in question was in that hex on that impulse, and that no other unit has been there since then. This would not be necessary with a non-playing referee.

**(M2.62) TRIGGERING:** Whenever a unit moves into a hex adjacent to a mine hex, the player controlling the mine announces this fact and the hex that the mine is in. [Possible exception: (M7.34).] The possibility of triggering is resolved by (M2.40). In such a case, the written record of the mine's location must be exposed to verify its location.

**(M2.63) DETECTION:** Hidden mines can be detected by a number of procedures given in (M7.0) in Advanced Missions. In Basic Set, they are detected whenever the ship moves adjacent to them (M2.62).

**(M2.7) UNITS CARRYING NUCLEAR SPACE MINES**

The following ships carry NSMs (large mines). Only the ships listed here, and any other ship specifically noted in its ship description rule, can carry large mines.

**(M2.71) SUBLIGHT ROMULAN:** The old Romulan sublight ships (Warbird, Hawk, and Snipe-S and sublight variants thereof) each carry one NSM, which is included in their BPV.

**(M2.72) OLD ROMULAN (EAGLE):** The other Old Series ships including the War Eagle, King Eagle, Pelican, Falcon, War Hawk, Battle Hawk, Chickenhawk, Scout Eagle, Freight Eagle, Snipe-A/-B/-P, and variants thereof, all carry one NSM, which is included in their BPV. Most of these ships are in Advanced Missions and Module R4.

**(M2.73) K-ROMULAN (KESTREL):** The KR Series "Klingo-Romulan" ships (including the KR and KF5R in Basic Set and other Klingon ships used by the Romulans in later volumes) can buy one NSM under the Commander's Option rules (S3.2).

**(M2.74) NEW ROMULAN (HAWK):** The New Series Romulan ships in Advanced Missions and Module R4 (including the SeaHawk, SkyHawk, SparrowHawk, FireHawk, SuperHawk, NovaHawk, Condor, and variants thereof) can buy one NSM as per (M2.73). This does not apply to PFs; see (M2.77).

**(M2.75) SMALL Q-SHIP:** The Romulan small Q-ship carries one NSM, which is included in its BPV.

**(M2.76) LARGE Q-SHIP:** The Romulan large Q-ship carries two "mine racks," each of which holds four NSMs. The mines on the Romulan large Q-ship are not included in its BPV, but can be purchased in excess of the Commander's Options (S3.2). See (M9.1) for mine rack rules.

**(M2.77) FAST PATROL SHIPS:** PFs (including Romulan PFs) never carry large nuclear space mines; exception (R1.PF4) Mine Warfare PFs. PF Leaders have a limited capability to carry transporter bombs; see (R1.PF6) and (M3.13).

**(M2.78) MINESWEEPERS:** Ships specifically described as being minesweepers and which have mine racks (M9.11) can carry large and small mines. These mines are purchased (or assigned by scenario rules); they are not part of the BPV of the ship or within the limits of (S3.27).

**(M2.79) MINELAYERS:** These are special ships used by many races. See (R1.12). They can carry large and small mines as per (M2.78). These mines are purchased (or assigned by scenario rules); they are not part of the BPV of the ship or within the limits of (S3.27).

**(M2.8) ADVANCED SYSTEMS**

These rules apply to systems in other products. You can ignore them if you only have Basic Set.

**(M2.81) DISPLACEMENT:** Mines cannot be moved by Andromedan displacement devices (G18.72) in Module C2. See also (M2.21), (G18.75), and (G19.49).

**(M2.82) STASIS:** Mines can be kept from triggering if held in a stasis field; see (G16.62) in Advanced Missions.

**(M2.83) ESG:** Armed automatic-explosive mines will trigger if hit by an expanding sphere (G23.0) in Module C1. (All mines in Basic Set are automatic-explosive.) Non-explosive mines (M5.1) will trigger against the ship generating the ESG if they survive the impact; see (M8.4) and (G23.61). See (M2.913) and (M2.92) for dummy mines.

**(M2.84) PA PANELS:** If a mine detonates in the same hex as a ship with PA panels (D10.0), the damage points are applied to the PA panels on the front of the hull (assuming the ship was moving forward; to the panels on the back of the hull if moving in reverse). This is treated as any other damage; damage in excess of PA capacity becomes internal damage.

If a mine detonates in an adjacent hex, the damage is absorbed by the facing panels.

Damage in excess of what the PA panels can absorb is resolved as internal damage points.

PA panels are in Module C2.

**(M2.85) MINESWEEPERS:** Ships designated as minesweepers (Advanced Missions) receive a number of special benefits; see (M2.45), (M5.1122), (M7.321), (M7.51), (M8.12), (M8.3) and (M9.1).

**(M2.9) DUMMY MINES**

**(M2.91) BASIC RULE:** Dummy mines can be used to deceive an opponent as to the structure of a minefield.

**(M2.911)** Dummy mines appear and operate in all ways as explosive mines, but will not explode, trigger, or do anything else.

**(M2.912)** Dummy mines cost the same as the real mines they simulate and can be substituted for real mines in (M6.2). They are much more expensive than dummy T-bombs because the dummy T-bomb relies on the transporter-signature to convince the enemy that a mine is indeed present. A dummy mine must wait for months or years and then appear to be the same as a real mine. Dummy mines are used primarily to create gaps through a minefield, not for deception.

**(M2.913)** Dummy (large) mines are destroyed by two damage points; dummy small mines by one damage point. If hit by an ESG (G23.61), they will reduce that ESG by that amount.

**(M2.914)** Dummy mines cannot be set to appear as deadman mines (M5.35).

**(M2.915)** Dummy mines can only be destroyed by the same procedures as real mines; see (M2.22).

**(M2.92) DUMMY T-BOMBS:** These are provided by (M3.224). They operate as in (M2.91) except that their cost is included with the real T-bombs and they are destroyed by one damage point.

**(M3.0) TRANSPORTER BOMBS**

Transporter bombs are small mines which can be placed by transporters. They are used to lay small impromptu minefields, stop mass attacks by drones or fighters, damage enemy ships, etc.

Transporter bombs are small mines and are, in all ways, treated exactly like the mines in (M2.0) except where noted differently. The primary differences are size of explosion, placement by transporter, and use of dummy mines.

**(M3.1) DEPLOYMENT**

**(M3.11) UNITS CARRYING T-BOMBS:** All ships (including bases and some PFs) may carry transporter bombs.

**(M3.12) COST:** T-bombs may be purchased as "Commander's Option Items;" see (S3.2).

**(M3.13) MAXIMUM LOAD:** A unit's T-bomb storage [as opposed to mines in mine racks (M9.1)] as defined in this rule is always available for laying out its shuttle hatches or by transporter with no delay to "move" it from one part of the unit to another. The number of T-bombs each type of unit can carry is shown on the chart below:

CLASS	MAXIMUM ALLOWED
Size-4 ships/bases	2
Size-3 ships/bases	4
Size-2 ships/bases	6
Size 1 (starbases)	12
PF leaders	1
PFs, Interceptors	0
Fighters, Shuttles	0

**NOTES:** Minesweepers and minelayers are a separate case; see (M9.1).

Mine warfare PFs (R1.PF4) can carry more mines, including T-bombs.

Some specialized shuttles can carry mines, specifically multi-role shuttles (J8.2) and minelaying shuttles (R1.F6). Some shuttles can carry mines as cargo but cannot lay them; see (G25.13).

**(M3.14) SSD:** Bombs carried on board a ship are not represented on the ship portion of the SSD (there is a place to record their use on the chart portion) and cannot be detonated while on board. Bombs cannot be captured, deactivated, or detonated by enemy boarding parties. See (G12.83) for the location of stored bombs on a ship undergoing separation. Stored T-bombs [and NSMs (M2.7)] are destroyed by the last Excess Damage hit; see (FD2.423).

**(M3.2) PLACEMENT**

**(M3.21) DROPPING:** Transporter bombs can be dropped in the same hex as the (laying) ship without dropping a shield by using the procedures in (M2.1). A ship can drop mines during the same impulse it lays T-bombs by transporter; see (M3.221).

**(M3.22) TRANSPORTER:** Bombs may be placed by transporters (G8.0) in any hex not occupied by a ship, planet, moon, or shuttle. **EXCEPTION:** (G13.616). This creates tactical limitations, in that transporters only work over a distance of five hexes, and a shield must be dropped to transport them. (Andromedans, without shields, are notorious for their profligate use of T-bombs.)

**(M3.221)** Each transporter can transport one bomb per turn and, if used to transport a bomb, cannot transport anything else on that turn; see (G8.112). [Exception: evacuations under (D21.31)] Transporter bombs cannot be placed inside an enemy unit. An enemy unit can detect that shields have been dropped; see (D3.54). A ship can drop mines during the same impulse it lays T-bombs by transporter; see (M3.21).

**(M3.222)** When a T-bomb is placed by transporter, its location is immediately known to all units within 35 hexes of the hex where the T-bomb is placed. T-bombs placed by transporter are never hidden (M2.6). See (M8.0) for minesweeping.

**(M3.223)** When a T-bomb is placed by transporter, it does not become active for two complete impulses (i.e., until the end of the transporter step of the second subsequent impulse). For example, a T-bomb transported on Impulse #7 would become active (armed) during Impulse #9 and (because of the relative order of movement and transporters in the Sequence of Play) could not be triggered before Impulse #10.

**(M3.224)** Ships can deceive their enemies by transporting "dummy" T-bombs or DTBs. A ship carries as many DTBs as it does real T-bombs. Simple "inert material" (such as the contents of the ship's garbage bins) can be easily distinguished from mines. Each DTB is destroyed by one point of damage. See (M2.92). Dummy T-bombs come only as part of the Commander's Options (S3.2). They are not included with mines bought for minelayers (or sweepers) outside of (S3.2). Dummy T-bombs will not function (i.e., will not fool anyone) if dropped rather than transported. Dummy T-bombs cannot be part of a pre-established minefield, nor can they be placed before a scenario begins (unless specified by the scenario, for example a situation where one ship is in pursuit of another when the scenario begins). Dummy T-bombs come ONLY with T-bombs purchased as part of Commander's Options. Dummy T-bombs cannot, under ANY circumstances, be replaced with real T-bombs.

**(M3.225)** Large mines (NSMs) cannot be placed by transporter. This rule *does* apply to Andromedans despite their ability to transport satellites ships (G19.4).

**(M3.226)** When they are laid or transported, T-bombs can be given target acceptance data as per (M2.14) and (M2.15).

**(M3.3) OPERATION**

**(M3.31) GENERAL:** Once placed, a T-bomb operates as an (M2.0) large mine, with the exception that the explosion is equal to 10 damage points. The conditions of (M2.2) apply. Like mines, once a transporter bomb is placed it cannot be moved (M2.21), even by transporters.

**(M3.32) RESTRICTIONS:** If a T-bomb is transported into a hex adjacent to the transporting ship, it is also under the restriction of (M2.3) in addition to those of (M3.22). These conditions run concurrently and must both be independently satisfied.

**SYNOPSIS OF RULES IN ADVANCED MISSIONS**

To aid in later integration of Basic Set with a whole range of advanced and expansion products, the Basic Set rules are filled with numerous cross-references to the rules from those other products. Of course, if you do not have a given product, then any rules from that product cannot be used; they do not impose any penalties or provide any benefits to the player. To aid in understanding the Basic Set rules, and to prevent confusion over these references to rules in other products, the following synopsis of these rules is provided.

**(M4.0) MINE TYPES AND SIZES:** There are not only explosive mines that blow up and damage ships, but also sensor mines that detect ships and send messages to other units and captor mines which fire weapons at approaching units.

**(M5.0) TYPES OF CONTROL SYSTEMS:** Not all mines simply explode when a ship goes by. Some can be turned on and off, some can be ordered to explode, some can be "chained" to explode when others do, and some can be set with a "deadman switch" to explode when they see a nearby mine explode.

**(M6.0) MINEFIELDS:** These rules are used to set up minefields around bases and other defended zones.

**(M7.0) DETECTING MINES:** There are several ways to detect mines, and it is possible to discover a minefield before you are in the middle of it.

**(M8.0) MINESWEEPING:** It is possible to destroy a mine without detonating it, and it is possible to cut your way through a minefield. Of course, this is much more difficult if the enemy is interfering with your sweeping operation.

**(M9.0) MINELAYING:** There is more to laying a minefield than just rolling mines out the shuttle hatch. This rule provides details on laying mines, mine racks, and minelayers.

**(M10.0) POWER-ABSORBER MINES** are used by the Andromedans as a defense against plasma torpedoes. Module C3.

**(M11.0) TRANS-CAPTOR MINES:** An Andromedan weapon which transports T-bombs toward approaching enemies. Module C3.

**FURTHER MINES:** As this edition went to press, several proposals for new mines were under review, but none had been assigned rule numbers or scheduled for a given product.

**END OF SECTION (M0.0) BASIC SET****NOTES ON RULEBOOK ORGANIZATION**

The rules superscript "N" has not been used in any SFB product to date (1990). The rules superscript "O" is not used due to possible confusion with "zero." The next section is "P" (Planets and Terrain).

**(P0.0) TERRAIN**

**PLANETS, ASTEROIDS, AND OTHER NAVIGATIONAL HAZARDS (Advanced)**

**(P1.0) GENERAL RULES**

Space is, of course, largely composed of empty or nearly empty volume. However, certain "terrain" features (planets, asteroids, etc.) do exist and become important elements of the game.

The rules in this section are used only when designated by the scenario, or when players create their own scenario and include terrain in it. In effect, this entire section might be considered as *OPTIONAL RULES*, although some scenarios require them, in which case they are not optional.

Beginning players should not use this section until they are familiar with the basic rules of the game.

**(P2.0) PLANETS**

**(P2.1) GENERAL RULES**

Planets are solid objects ranging from a few thousand to a hundred thousand kilometers or more in diameter. Generally, they block fire and movement.

Units can (sometimes) land on planets. Bases can be installed on planets.

**(P2.2) TYPES OF PLANETS**

Within *STAR FLEET BATTLES* there are three general types of planets: class-M planets (such as Earth), moons (also known as small planets, or sometimes small moons), and gas giants. These are described in this section.

**(P2.21) CLASS-M PLANETS:** This type of planet (two counters are included in Basic Set) completely fills one hex.

**(P2.211)** No weapons may be fired through a hex containing a class-M planet (P2.32).

**(P2.212)** Units cannot enter a hex containing a class-M planet unless they are in the act of landing on it (P2.4) or executing "low flight" (P2.423). Note, however, that only certain units can land on planets. Entering a planet hex by any other means (P2.812) results in a crash landing (P2.431). Living monsters are never forced to enter atmosphere hexes and, if they do, are not penalized or damaged.

**(P2.213)** Most planets of this size have an atmosphere, but some do not. Unless it is specified in the scenario that a class-M planet does not have an atmosphere, it is assumed to have an atmosphere. (If it doesn't, it isn't technically class-M, but it could be the same size.) The atmosphere is presumed to be the outermost 100 kilometers of the hex (which is 10,000 kilometers across). This has an effect when units that are landing (or have landed) on the planet are engaged in combat. A shuttlecraft, monster, or ship in the planet's hex might be physically on the surface or flying through the atmosphere. A launched seeking weapon would always be "flying" while a non-orbital base would always be on the surface.

**(P2.22) GAS GIANTS:** This type of planet (similar to Jupiter or Saturn) has a small solid core and a thick atmosphere.

**(P2.221) SIZE:** Gas giants come in various sizes. The counter is used to mark the center of the planet. Jupiter would be 14 hexes across, Saturn 11 (its rings would be 27 hexes across at their outside diameter), Uranus 5 hexes, and Neptune 4. Saturn is portrayed on a special map in Module B, and other products have "planet cut outs" for planets of 3-14 hexes size.

**(P2.222) LARGE GAS GIANTS:** The outermost ring of hexes of gas giants 7 hexes or more in diameter is considered to be entirely atmosphere. The ring of hexes immediately inside this atmosphere ring is considered to have the same thin layer of atmosphere as a

class-M planet (i.e., with a planetary surface). See (P2.6) below (e.g., Saturn is a 9-hex solid body which includes a fringe of atmosphere, plus one hex of atmosphere all around, total 11 hexes). Gas giants 6 hexes and smaller have only the single atmosphere layer of class-M planets.

Units can enter and maneuver through the atmosphere, but are under certain restrictions (P2.8). The "large gas giants" (i.e., those with two hexes of atmosphere) are unique in that units cannot land on (or be built on) the surface. (There actually is no surface, just an increasingly dense layer of gas to the point where the hull of the ship could be crushed.) Any ship which attempts to land or which crashes on this "surface" suffers a catastrophic landing (P2.435).

**(P2.223) RINGS:** Many, if not most, gas giants have "rings" (such as the spectacular rings of Saturn) surrounding them. These rings extend a specified number of hexes (those of Saturn would start in the 5th hex above the planet's surface and extend to the 10th; the 6th ring would be empty space). Ring hexes are treated as asteroid hexes (P3.0) except that they use the damage table below [instead of (P3.2)] and each hex of ring material counts as 1/2 point of ECM (round fractions of 1/2 up) rather than the 1 point specified in (P3.33).

RING MATERIAL DAMAGE TABLE				
DIE ROLL	SPEED			
	1-6	7-14	15-25	26+
1	0	0	0	0
2	0	0	0	2
3	0	0	1	5
4	0	1	3	7
5	0	3	5	10
6	0	5	7	15

Legendary navigators (G22.812) can reduce the damage; nimble units (C11.21), and outstanding (G21.228) or poor crews (G21.128) have a die roll shift on this chart; erratic maneuvering energy (C2.45) adds to speed (P3.222).

**(P2.224)** Units cannot enter a hex containing part of a gas giant (or its atmosphere) unless they are in the act of landing on it (P2.4) or executing "atmospheric flight" (P2.423). Note, however, that only certain ships (listed in Annex #7B) can land on planets. Entering a gas giant hex by any other means (P2.812) (e.g., at practical speeds over 1) results in an immediate catastrophic landing (P2.435), even if entering only the upper atmosphere hex (i.e., you burned up in the atmosphere). Living monsters are never forced to enter atmosphere hexes and, if they do, are not penalized or damaged.

**(P2.23) SMALL PLANETS AND MOONS:** Small airless planets (similar, perhaps, to Titan, Pluto, Mercury, or Earth's Moon) do not completely fill the hex they are in.

**(P2.231)** Units (and other objects) entering a small planet hex have a probability of colliding with the planet based on their speed as follows:

PLANETARY COLLISION TABLE		
SPEED	SAFE	COLLISION
1	1-6	-
2-14	1-5	6
15-22	1-4	5-6
23-27	1-3	4-6
28+	1-2	3-6

If a collision occurs, treat it as an immediate crash landing (P2.431). Otherwise, the ship may begin the landing procedure or continue moving through the moon hex.

Legendary navigators (G22.812), nimble ships (C11.29), outstanding (G21.228) and poor crews (G21.128), and units using EM (C10.47) have a die roll shift on this chart. A result less than 1 is treated as 1; a result more than 6 is treated as 6.

Monsters never crash into moons. See also (D21.22).

**(P2.232)** Moons between two units have a 50% chance of breaking the lock-on; see (P2.3221).

**(P2.3) EFFECT OF PLANETS ON COMBAT**

**(P2.31) DESTRUCTION** There is no practical way in which a ship could destroy a planet, but smaller bodies can be destroyed.

**(P2.311)** A planet might be "devastated" by scoring a number of damage points (specified in the scenario; if not specified, assume 200) on each hex side of the planet. See (P2.525).

**(P2.312)** Large asteroids (P3.4), meteors (SH3.0), moons (P2.23), etc. cannot be destroyed, but can be "broken up" into smaller fragments by weapons fire. This requires a number of damage points specified by the scenario. (Assume 400 points for a "dinosaur killer" asteroid a few miles in diameter, up to 5,000 damage points for a small moon 50 miles in diameter.)

**(P2.32) BLOCKING FIRE:** Planets can block direct fire and interfere with lock-ons and seeking weapons.

**(P2.321) DIRECT-FIRE WEAPONS** cannot be fired through a hex containing a planetary surface; it can fire along the edge. They can be fired through a hex containing a moon; see (P2.3221).

See (E12.54) for special cases involving web casters. See (D17.151) for probes.

**(P2.322) LOCK-ON:** If a planet occupies a hex that is directly between two units (that is, a line drawn from the center of each hex passes through any part of, but not along the edge or through a corner of, a hex containing a planetary surface, or part of a planetary surface), the two units cannot maintain a lock-on to each other. In this case, during the Activity Segment of the first impulse after the obstacle has passed, roll again for a lock-on (D6.11) within the limitations of the rules.

[NOTE: In a more technical sense, the units do not have target tracking to each other, meaning that they cannot fire at all. It would not be possible to fire through a planet using passive fire control (D19.0). A unit on passive fire control would have to re-acquire a 'target tracking solution' or 'firing solution' before it could fire.]

**(P2.3221)** Small planets and large moons have only a 50% chance of breaking the lock-on (P2.232) of either/both unit. Roll for this every impulse that the planet is in the direct line between the ships. If the lock-on is broken, it cannot be re-established until the planet is out of the direct line.

**(P2.3222)** If seeking weapons are controlled by a ship which loses its lock-on in this manner, those weapons will be removed from the board unless control can be transferred to another unit (F3.5) or to the weapons themselves (F3.42), in which case see (P2.33). If the seeking weapon (controlled by the ship) is blocked from lock-on by the planet (most seeking weapons do not have their own lock-on, but the procedure is the same), the weapon loses lock-on because it cannot see the target that the ship's sensors are locked onto.

**(P2.3223)** If a WW goes behind a planet, treat this as if the target of the seeking weapons had gone behind the planet (which is in fact what happened). Weapons which accept the planet as their target will not revert to the ship even if the ship voids its WW.

**(P2.3224)** If a ship commits a voiding action while the unit controlling the seeking weapons targeted on a WW has no lock-on to the ship, the WW is not voided for purposes of those seeking weapons; see (J3.404).

**(P2.3225)** A base on a planetary surface cannot lock-on targets outside of its firing arc; see (P2.62).

**(P2.33) SELF-GUIDED SEEKING WEAPONS** providing their own guidance under (F3.42) lose their target if a planet comes between them and that target (P2.322). They acquire the planet as their new target and proceed to hit it. They will strike and explode on the planet. If it is a friendly planet to one player, this may result in considerable loss of life and property and should be suitably penalized (P2.525). One victory point per point of warhead strength may be used if no other penalty is specified in the scenario (maximum of 200 points per hex side).

In the case of type-VI drones, see (FD2.54) for reduced damage effects.

**(P2.34) TRACKING:** A planet between the seeking weapon and the ship controlling it does not cause the weapon to lose tracking (F3.3). It receives its instructions by sub-space.

**(P2.35) FIRING:** The effects of firing from a planetary surface, to a planetary surface, and through an atmosphere are given in (P2.5). That section also provides rules for firing at a unit that has landed on an airless planet.

**(P2.36) OTHER EFFECTS:** The effect of planets and atmospheres on other systems is found in:

- Expanding sphere generators (G23.65)
- Tholian webs (G10.114).
- Tractor beams (G7.241) and (G7.75).
- Stasis field generators (G16.61) and (P2.546).
- Power absorbers (D10.4123).
- Anti-drones (P2.548).
- Cloaking devices (G13.49) and (P2.523).
- Wild weasels (J3.48) and (P2.322).

**(P2.4) LANDING ON PLANETS**

It is possible for all ships and shuttles to land on planets although in most cases this results in destruction of units not designed for planetary landings.

**(P2.41) PROCEDURE FOR LANDING OR TAKING OFF FROM A PLANET OR OTHER BODY**

**(P2.411) LANDING PROCEDURE:** Units landing on planets with an atmosphere use the following procedure. If there is no atmosphere, skip Steps #1 and #2, entering the landing hex at speed 1 (maximum for entire turn) on Step #3; see (P2.421).

**(P2.4111) STEP #1.** The unit must end the turn in a hex adjacent to the planet. [The unit can skip Step #1 so long as its practical speed and effective speed when entering the planet/atmosphere hex is no more than 1. This could be accomplished by using (C12.0) speed changes or by using (C8.41).]

**(P2.4112) STEP #2.** On the next turn, it moves into an adjacent hex containing the planet at a maximum speed of 1. This movement requires engine power equal to one hex of movement. If this energy is not expended, the ship does not move (i.e., does not enter the atmosphere and start the landing procedure). A ship can enter the atmosphere hex using tractors (P2.432) instead of engines. A ship that enters a planet hex at a speed of more than 1 crashes (P2.812). Alternatively, the ship could end normal movement in an atmosphere hex with emergency deceleration (C8.22).

**(P2.4113) STEP #3.** On the next turn, it is "descending" for the entire turn and cannot exceed a speed of 1. This requires engine power equal to one hex of movement [exception: (P2.433) and (P2.432)] and might be (but is not required to be) used to move the ship to an adjacent hex side of the planet (P2.61). If this power is not allocated, the unit crashes immediately (P2.431). The unit lands on Impulse #32 of this turn. [See types of landings (P2.43).] If it landed, the unit begins the next (fourth) turn in a landed condition (P2.45).

Instead of descending, the unit might choose to execute "atmospheric flight" (P2.8) [which does not count as "descending"]. The unit can (but is not required to) use this atmospheric flight to move to an adjacent hex side (P2.612).

If the atmosphere is more than one hex deep (P2.63), this turn could be used to enter a lower atmosphere hex although an actual landing would be impossible. The unit would simply execute atmospheric flight at the lower level until it came back up.

**(P2.412) TAKE OFF PROCEDURE:** Taking off from a planet with an atmosphere is conducted by the following procedure. If there is no atmosphere, skip Step #2.

**(P2.4121) STEP #1.** During the first turn, the unit expends one unit of power and leaves the surface on Impulse #32 (remaining in that hex). This takeoff requires engine power equal to one hex of movement (P2.80). If this power is not allocated, the unit remains on the planetary surface. [The unit could use tractors (P2.432) to take off. This could be done with allocated or reserve power.]

**(P2.4122) STEP #2.** The second turn is spent "climbing" to the atmospheric flight level (still in the planet hex). This requires engine power equal to one hex of movement (P2.80), but the ship does not leave the hex. If this power is not allocated, the unit crashes (P2.431). [Exception: Units able to execute an

aerodynamic landing (P2.433) or gravity landing (P2.432) may do so.) The unit could use tractors (P2.432) to hold itself in the atmosphere.

**(P2.4123) STEP #3.** On the third turn, the unit has three options.

It can begin normal movement, but only if the first hex of movement takes it out of an atmosphere hex into open space (it continues moving at whatever speed was allocated for the remainder of the turn).

The third turn could alternatively be used to execute "atmospheric flight" (P2.8) within the atmosphere instead of leaving the atmosphere and entering space. This could be used to move to an adjacent hex side, but this is not required. The unit would then have the same three Step #3 options on the next turn.

The final option for the third turn is to descend, resulting in the unit landing on Impulse #32 (in the same hex/hex side). This landing must be within the limits of the rules. The first two options require power; if no power is available, the unit must take the third option and if not qualified for (P2.433) will crash.

If the atmosphere is more than one hex deep, the unit could use this turn to change from an upper atmosphere hex to a lower one and vice versa. Of course, the unit could never land on the surface.

If in an upper atmosphere hex and no power is applied, the ship will "fall" to the lower level, where it will be "in flight."

**(P2.42) MODIFICATIONS TO THE PROCEDURE:** In several cases, modifications to this procedure are required by the circumstances.

**(P2.421)** In the case of planets without an atmosphere, the turn of "climbing" or "descending" is skipped. These rules can be used to land on asteroids and moons.

**(P2.422)** In the case of large gas giants, one "descending" (or "climbing") turn must be spent in the "upper atmosphere hex" before entering the adjacent "lower atmosphere hex" (or leaving the atmosphere).

**(P2.423)** A unit can enter a planetary surface hex (remaining in the atmosphere) without landing by conducting Steps #1, #2, and #3 of (P2.412) and then using (P2.8). This might be done by a ship trying to get closer to a surface target or trying to gain some of the shielding benefits of the atmosphere. Units which cannot land CAN perform atmospheric flight.

**(P2.43) TYPES OF LANDINGS:** Units can make safe controlled landings (which do not damage the unit and which allow it to take off again) or uncontrolled (i.e., "crash") landings.

**(P2.431) CRASH LANDINGS:** Unless otherwise specified, units landing on planets (or moons) are destroyed by the procedure. This would usually be done only if the unit was badly crippled and a crash landing on a planet was the only chance that some of the crew would survive.

**(P2.4311)** In this case, there is a 50% chance for EACH crew unit (or pilot if it is a shuttle) to survive. (Roll for each crew unit separately; 1-3 indicates survival.) Certain ships listed in Annex #7B (e.g., most Orion ships and Federation saucers) have a better chance of crew survival (die roll 1-5). The survival of the crew units while on the planet (breathable atmosphere, gravity, food sources, disease, predators) is outside the scope of *STAR FLEET BATTLES*. (Obviously, survival in a non-breathable atmosphere would be only a few hours, perhaps long enough for rescue in the next scenario of a campaign game.)

**(P2.4312)** Wreckage (the unit does not explode) and the survivors are presumed to be located on the hex side where they landed. It can be presumed that any necessary procedures (such as dropping the warp engines or shutting down the reactors) are performed by the crew without special attention by the players.

**(P2.4313)** Legendary navigators (G22.85) and outstanding (G21.228) or poor crews (G21.128) have a die roll shift when rolling for crew survival.

**(P2.4314)** It is impossible to crash land on a large gas giant (P2.222); any landing there would be catastrophic (P2.435).

**(P2.432) GRAVITY LANDING SYSTEM:** Certain units may make a safe, controlled, landing using their tractor beams as an anti-gravity system. Units capable of this are listed in Annex #7B. This system can also be used in various steps of the Take Off Procedure. If no working tractor beams (with power applied) are available, this system cannot be used.

**(P2.4321)** Landings by this method do not damage the unit, and it can take off again later.

**(P2.4322)** The system requires an amount of power applied to a tractor (from any source) equal to the cost of moving five hexes for every turn of the landing procedure (the energy must be allocated on each turn; it cannot be from previous turns).

**(P2.4323)** While a unit cannot land in an atmosphere two hexes deep, it could use this system to "hover" in the lower atmospheric flight level.

**(P2.4324)** Any unit not listed in Annex #7B can use this system, but while the crew would arrive safely, the unit itself (not designed to land in this manner) would be wrecked (destroyed, no explosion).

**(P2.4325)** Any pod with a tractor beam can use this system (within the limits of the rules) at a cost of 1 point of power.

**(P2.433) AERODYNAMIC LANDING SYSTEM:** Certain units may make a safe, controlled, landing without the use of any power once inside an atmosphere. (They glide in like the space shuttle.) Units capable of this are listed in Annex #7B.

**(P2.4331)** Units can only descend by this method; they cannot climb or use atmospheric flight.

**(P2.4332)** Landings by this method do not damage the unit, and it can take off again later (by some other system as you cannot "glide" up).

**(P2.4333)** Naturally, this type of landing is only possible in an atmosphere. While the unit cannot land in an atmosphere two hexes deep, it could "glide" into the lower atmosphere and then begin powered flight under (P2.8).

**(P2.434) POWERED LANDINGS:** Certain units may make a safe, controlled, landing using their normal engine power equal to one hex of movement per turn (P2.80). Units capable of this are listed in Annex #7B.

**(P2.4341)** Landings by this method do not damage the unit, and it can take off again later.

**(P2.4342)** Powered landings can be made with or without atmosphere.

**(P2.435) CATASTROPHIC LANDINGS:** In this case, the unit impacts on the surface at considerable speed and out of control. The unit is destroyed and explodes on the surface as per (D5.2). The crew is all killed unless they escape under (D21.0). This type of landing is used on large gas giants (P2.222) and when entering a planet hex as a result of tumbling (C6.556). See (P2.311) for damage to planets.

**LANDING EXAMPLE:** An Orion CR wishes to land on a planet. The planet is a one-hex Class-M planet in hex 2215.

**TURN #3:** The CR ends its movement in hex 2116 facing A. His turn and sideslip modes are satisfied. This is Landing Step #1.

**TURN #4:** The CR enters 2215 (with a sideslip on Impulse #32, using one point of engine power) and denotes its position as 2215/2116A (P2.61). That is, it is in hex 2215 on the hex side facing 2216 and is in the "A" atmosphere. This is Landing Step #2. The CR cannot use its free aerodynamic landing ability because it has not entered the atmosphere.

**TURN #5:** The CR decides to execute "atmospheric flight" and move around the planet to 2215/2115A on Impulse #32. For whatever reason, the CR uses the gravity landing system (P2.432) on this impulse, spending 3.33 energy points. This was done in lieu of Landing Step #3. The CR cannot use its free aerodynamic landing ability because it is not descending, but it instead moves to another hex side by (P2.80).

**TURN #6:** The CR decides to execute atmospheric flight and move around the planet to 2215/2214A, using one point of power for powered flight on Impulse #32. This was done in lieu of Landing Step #3. The CR cannot use its free aerodynamic landing ability because it is not descending, but it instead moves to another hex side by (P2.80).

**TURN #7:** Being on the hex side where he wanted to land, the CR captain uses aerodynamic flight (no power) to descend on Turn #7, landing on Impulse #32. This was Landing Step #3.

**TURN #8:** The CR remains on the planet.

**TURN #9:** The CR takes off again (having completed its business), actually leaving the surface on Impulse #32. Take-off Step #1.

**TURN #10:** The CR ascends using powered flight (P2.80). It is still in 2215/2214A. Take-off Step #2.

**TURN #11:** The CR uses powered flight (P2.80) to move to 2215/2315A, actually changing hex sides on Impulse #32. This is one of the Take-off Step #3 options.

**TURN #12:** The CR allocates power for speed 10 and climbs out of the atmosphere to hex 2315 (the only space hex it can legally enter) on Impulse #4. This one of the Take-off Step #3 options.

**TURN #13:** The CR accelerates to a speed of 20 and thereafter proceeds to get out of the system before any police come around asking questions.

**(P2.44) TRACTOR BEAMS:** Tractor beams can be used to raise objects from and lower objects to a planetary (or moon) surface under certain conditions and restrictions. This procedure is used for a unit in space to lower a unit to (or raise it from) a planetary surface. A unit cannot use this system to rotate itself to the surface; use (P2.432) instead.

**(P2.441) RAISING:** Objects (including ships) can be raised from a planetary surface by using the tractor rotation rules (G7.7). The first rotation raises the object into the "atmospheric flight" level, while the second rotation can pull the object out of that hex and into an adjacent space hex. (In the case of a deep atmosphere, the tractor unit could of course never have been on the "surface". The first rotation would pull it from the "lower atmosphere flight level" to the "upper atmosphere flight level," and the second would pull it into space.) The restrictions in (G7.323) will virtually require the unit doing the lifting to be at a speed of 1 or 0. Ground bases with active stabilizers (G29.0) cannot be lifted in this manner. If the tractor is released while the object is in the atmospheric flight level, the object can begin the landing procedure at Step #3 or the take-off procedure at Step #2. If not capable of either, it will crash and all crew units will be killed. Use the crash landing procedure in (P2.431).

**(P2.442) LOWERING:** Objects (including ships) can be lowered to a planetary surface by using the tractor rotation rules (G7.7). The first rotation moves the object down into the "atmospheric flight" level, while the second rotation can lower the object to the planetary surface for a safe landing. (In the case of a deep atmosphere, the second rotation would move the object into the next lower layer of atmosphere. The object could, of course, not be lowered to the "surface;" any attempt to do so would destroy the lowered unit due to pressure.) The restrictions in (G7.323) will virtually require the unit doing the lowering to be at a speed of 1 or 0. While ground bases (of any type) can be lowered, they would be inactive (treated as cargo with no shields) as there is not time during a scenario for their positional stabilizers (G29.0) to deploy. If the tractor is released while the object is in the atmospheric flight level, the object can begin the landing procedure at Step #3 or the take-off procedure at Step #2. If not capable of either, it will crash (P2.431).

**(P2.443) ENEMY UNIT:** Permission of the enemy unit to lower it into an atmosphere is not specifically required, but the enemy unit may be able to prevent it from happening by various means provided in the rules.

**(P2.45) LANDED ON PLANET:** A unit which has landed on a planet is under several restrictions.

**(P2.451)** A unit landed on a planet cannot expend power for movement except to take off (P2.412).

**(P2.452)** For combat purposes, see (P2.5).

**(P2.5) EFFECTS OF ATMOSPHERE ON COMBAT**

If a target is located in an atmosphere, the accuracy of units firing at it is reduced. This is generally given in terms of ECM (electronic counter measures, or jamming) points. Note that this system can still be used even if the electronic warfare section (D6.3) is not being used for other purposes. Simply use the EW rules, but assume that the effect of an atmosphere [and certain other effects listed in (D6.3) standard EW system] is the only source of ECM and that there is no ECCM.

**(P2.51) EW EFFECTS OF AN ATMOSPHERE:** When the line of fire for direct-fire weapons passes through an atmosphere, the firing unit is penalized by 1 point of ECM for each hex of atmosphere that the line of fire passes through. This ECM can be offset by ECCM.

See also (P2.54) for degradation of effect for certain weapons.

See also (D17.2251) for effects on tactical intelligence.

See also (P2.722) for the ground base exemption.

**(P2.51)** This includes fire from, through, into, or between atmosphere hexes and includes the hexes containing the firing and target units (assuming that such hexes are atmosphere hexes). If both units are in the same hex, this is considered to be one atmosphere hex. If neither the firing unit or target is in an atmosphere, but the line of fire passes through atmosphere hexes, the firing unit is penalized by the ECM penalty for each hex of atmosphere the line of fire passes through.

**(P2.512)** When resolving fire through an atmosphere, determine the most direct line of hexes from the firing unit to the target. The line is traced from the center of the hex to the center of the hex. This line of hexes cannot be longer than the true range, but can be the minimum number of atmosphere hexes. See (P2.63).

**EXAMPLE:** In the illustration below, fire from 1434 to 1631 crosses 1533, 1532, and into 1631 (three atmosphere hexes).

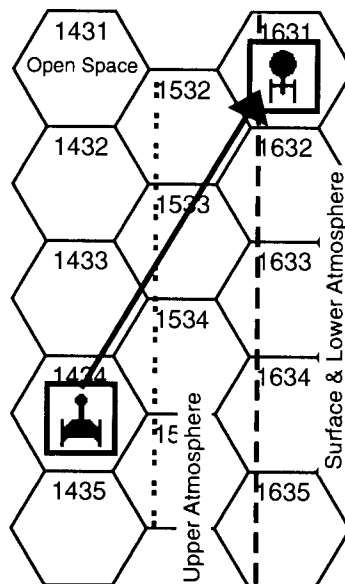

**(P2.52) TARGET ON A PLANET:** When a target is on a planetary (moon, large asteroid) surface, it gains two points of ECM (the "ground clutter bonus") plus the EW effect of any atmosphere (P2.51). ECCM can be used to offset this type of ECM. See also (P2.54). For ground bases, see (P2.524). Note that a unit in "atmospheric flight" over a planet without any atmosphere would gain no EW benefits. See also (R1.14).

**(P2.521)** In this case, the owning player may designate which of his shields is facing the unit firing at it. The designated shield is used for all firing units for as long as that unit remains on the planet's surface. Only weapons that can fire through the shield can be fired.

**(P2.522)** Seeking weapons fired at a planet are targeted on specific points or installations. See (D17.4) for the ability to locate some target types. In scenarios where general damage to the planet is called for (P2.525), the weapon crews are selecting appropriate cities or industrial areas on the hex side selected by the player. See also (F4.22).

**(P2.523)** A cloaked unit landed on or which lands on a planet or asteroid remains cloaked unless the cloak is voided by some other factor.

**(P2.524)** Planetary bases, being fixed installations, do not receive the ground clutter bonus in (P2.52). See (P2.713) and (P2.76) for other effects.

**(P2.525)** Sometimes the objective is "general destruction," simply bombarding the planet to destroy buildings, settlements, roads, crops, and other "infrastructure" that are not specific units in the SFB sense. In this case fire is resolved as within these rules (P2.52) for purposes of atmosphere, EW, and other effects that may reduce weapons efficiency.

Depending on the scenario rules, this general destruction may be done for victory points (limit 200 points of damage per hex side) or simply to achieve a level of victory. If no such rules are provided, accidental damage due to (P2.33) is resolved as provided in that rule.

See also (P2.746) and (F4.22).



**(P2.53) FIRING FROM A PLANET:** When any firing unit is on a planetary (moon, large asteroid) surface, the target of its fire gains the effect of two points of ECM plus the EW effects of atmosphere (P2.51). This ECM can be overcome by ECCM. The firing arc is limited (P2.62) to 180°.

A planetary base does not suffer this penalty; see (P2.722).  
See also (P2.54) for degradation of effect for certain weapons.

**(P2.54) FIRING THROUGH AN ATMOSPHERE:** Firing weapons through an atmosphere degrades their performance. The specific effect depends on the weapon. The atmosphere of a small planet counts as one hex of atmosphere for this purpose. For gas giants, count each hex of atmosphere between the firing unit and the target, including (if appropriate) the hex occupied by the firing unit and the target. These restrictions apply to weapons fired "up" from the surface, "down" from space, and from one atmosphere hex to another. Two units in the same atmosphere hex are treated as firing through one hex of atmosphere for purposes of this rule only. For planetary bases, see (P2.722).

**(P2.541)** For phasers and fusion beams, add one to the die roll (cumulative with any other shifts) for each hex of atmosphere (E1.8); this is cumulative with other modifiers.

**(P2.542)** For photon torpedoes, hellbores, plasmatic pulsar devices, plasma bolts, web fists, maulers, and anti-matter probes, reduce the strength by 25% (of the original strength) for each hex of atmosphere.

The 25% loss for a second (or subsequent) hex of atmosphere is cumulative with previous hexes, i.e., deduct 50% for two hexes, 75% for three, and 100% for four or more.

Round fractions down when calculating the loss (strength 6, 25% loss is 1.5, drop the .5, result is 5, loss is 1).

For PPDs, deduct the 25% of the total strength, but deduct it from the main element only (leaving the splash elements intact) until the main element is reduced to 1 point, then deduct subsequent losses from the splash elements and (after both are gone) from the main element.

**(P2.543)** Disruptor bolts lose one point of warhead strength for each hex of atmosphere. Disruptors are, the player will note, just about the most effective weapon for bombarding planets. This may tell you more about the Klingons, Lyrans, and Kzintis than they would prefer you to know.

**(P2.544)** TR beams count each hex of atmosphere as five hexes for range purposes.

**(P2.545)** Seeking weapons (drones, plasma torpedoes, suicide shuttles, scatter-packs, etc.) move in an atmosphere by (P2.85).

**(P2.546)** Expanding sphere generators (G23.652) and stasis field generators (G16.61) do not function through or into an atmosphere hex. See (G10.114) for details on web.

**(P2.547)** Planets and moons have an effect on explosions. See (P2.31) for the effect of these explosions on the planet.

**(P2.5471)** Self-destruction (D5.55) and mine explosions (M2.501) do not extend into or through an atmosphere.

**(P2.5472)** Planets block the effects of ship and mine explosions (D5.55) for units in space; if a planet is between a unit and the blast, the unit suffers no damage from the blast. A moon would not block the effects of the explosion except for units landed on or in atmospheric flight above non-adjacent hex sides. See (P5.354) for pulsars.

**(P2.5473)** A mine or ship explosion in an atmosphere hex affects only that hex (and its hex sides if it is a surface hex).

**(P2.5474)** The damage from an explosion in an atmosphere hex is applied to the planet as general destruction on the nearest planetary hex side in the same hex (if any) and not to units on the planet. The explosion would affect units in "atmospheric flight" in that hex normally (P2.80). See (P2.746).

**(P2.5475)** The damage from an explosion near a planet or moon without an atmosphere is applied to the planet as general destruction on the nearest planetary hex side and not to units on the surface. The explosion would affect units in "atmospheric flight" normally. See (P2.746). On a moon, the damage is divided over the hex side and the two adjacent hex sides.

**(P2.548)** Anti-drones can fire into or out of an atmosphere hex, but cannot fire through an atmosphere hex and cannot fire from one atmosphere hex into another atmosphere hex; ADDs can fire along the edge of an atmosphere. ADDs on planetary bases fire at range 1 (or 0) as if it were range 3. ADDs on planetary bases fire normally at ranges 2-3.

**(P2.55) ELECTRONIC SYSTEMS:** Atmosphere does not in any way impede the lending of electronic warfare or block the functioning of special sensors.

**(P2.6) STRUCTURE OF PLANETS AND ATMOSPHERES**

The existence of a planet, particularly one with an atmosphere, causes certain complications to the normal operation of the game.

**(P2.61) HEX SIDES:** All units in a planetary surface hex (whether landed or in an atmosphere) must be designated as to the "hex side" that they occupy. This designates the specific area of planetary surface that they are on (or over). Note that this is not done with asteroids [not even with large asteroids (P3.4)], only with planets.

See (P2.8) for movement within an atmosphere, (P2.41) for landing and taking off from a planet, and (D15.542) for movement by ground troops on a planet. This rule does not apply to airless moons.

**(P2.611)** Note the illustration below. A shuttle in hex 0421 plans to land on the planet in hex 0322. If it enters the planet hex directly from 0421, the shuttle will be automatically designated as being in hex 0322 facing hex side 0421.

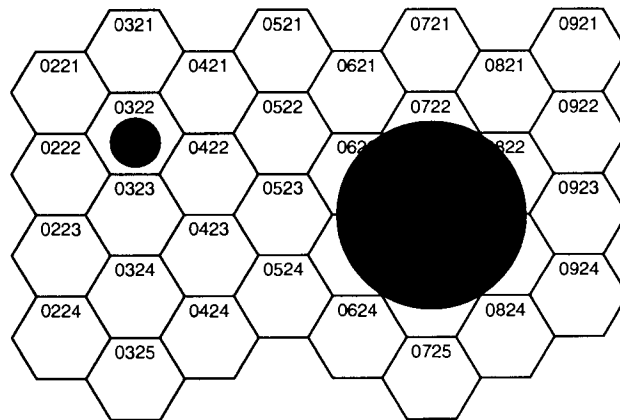

The terminology used to reflect this is: 0322/0421A, where the first number is the hex number of the planet's hex, the second number is the hex side it is facing, and the letter indicates if the unit is in the atmosphere (A) or has landed (L). Note two uses of the word "facing," one defining the hexside of the planet and the other the direction the unit is facing.

**(P2.612)** If the shuttle in 0322/0421A proceeds to land on the planet, it MUST land on 0322/0421L. The shuttle could move, taking an entire turn and moving through the atmosphere, to an ADJACENT hex side (such as 0422 or 0321). Thus a shuttle in the atmosphere at 0322/0421A has the options of landing in 0322/0421L, moving to 0322/0422A or 0322/0321A, or moving back to 0421. Similarly, a shuttle that has landed at 0322/0421L which later takes off can only move to 0322/0421A.

**(P2.613)** This is more complex in the case of a larger planet, but only marginally so. Note that a ship in 0621 could move to 0622/0621A or to 0722/0621A. From 0622/0621A it could: land in 0622/0621L, move to 0622/0522A, move to 0722/0621A, or return to 0621. [It could not go to 0522 because (P2.612) requires it to exit at the point it entered unless it spends time changing its relationship to the planet.] Note also that due to the two dimensional nature of the game no unit could move into hex 0723.

**(P2.62) FIRING ARCS:** The firing arcs of units on a planetary surface (or in low atmosphere) are, basically, limited to 180°. (Units with smaller arcs are not expanded to this size.) This arc also determines which enemy units can fire at that unit.

Note in the illustration below the firing arc for a base in 0327/0426L. Any unit in the arc could fire at, or be fired at by, a base in 0327/0426L. In the case of a larger planet, the same 180° rule applies. A base in 1225 (either side) would have the firing arc designated by A; the firing arc of a base in 1223 is designated by B. See (P2.863) for more on weapon arcs.

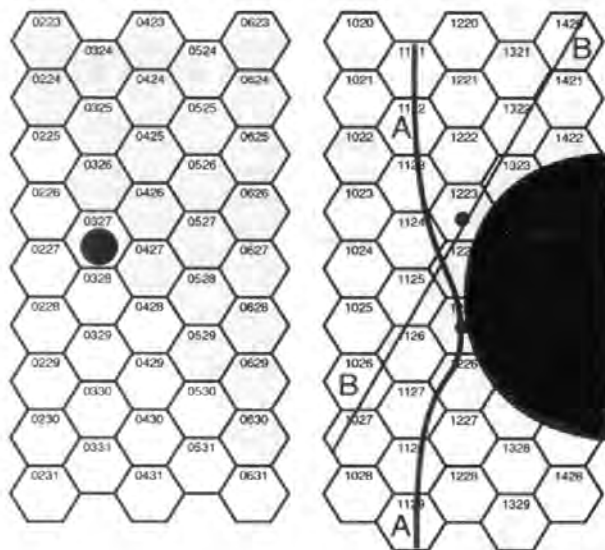

**(P2.63) ATMOSPHERE DEPTH:** The depth of the atmosphere is critically important in determining both combat and movement aspects of planetary combat. In the case of a class-M planet or a gas giant six hexes or less in diameter, the atmosphere is considered to be within the planet's surface hex(es). No "straight line" operation can involve more than one "hex" of atmosphere.

In the case of deep atmospheres on larger gas giants, this becomes somewhat more complicated. Note the large gas giant shown in the illustration below. As it has a diameter of 11 hexes, the outer row of hexes (1532 for example) are considered to be atmosphere hexes.

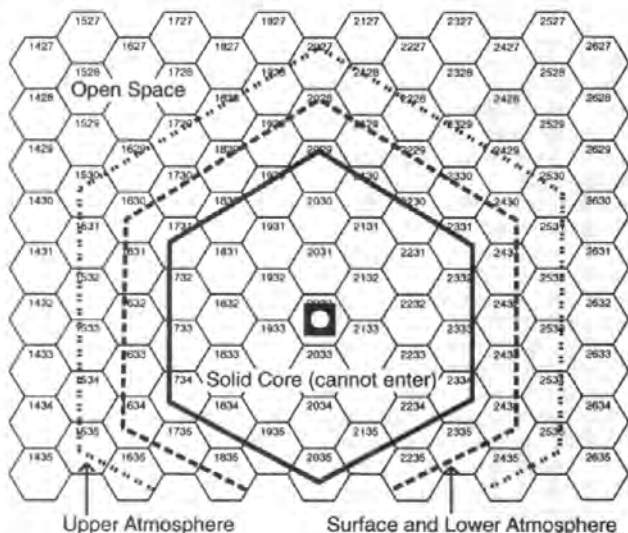

A unit in hex 1532 would not need to designate a hex side because it is not in a planetary surface hex. Fire between hexes 1432 and 1631 would cross two atmosphere hexes (1532 and 1631). Fire between hexes 1434 and 1631 would cross three atmosphere hexes (1533, 1532, 1631). Moving along the border between an atmosphere (1534) and non-atmosphere (1433) hex does not count as an atmosphere hex.)

Movement from hex 1532 to the planet's surface hexes would be conducted exactly as it would if 1532 was not an atmosphere hex, as in (P2.61) above, except of course, that the unit would have taken a turn to reach 1532 because it is an atmosphere hex.

**(P2.7) BASES ON PLANETS**

Bases of all sizes can be placed on planets. These are known collectively as ground bases or planetary bases. Ground bases come in three sizes:

Large ground bases include starbases, battle stations, base stations, SAM bases, BLM bases, and other (normally) orbital bases which are (for whatever reason) built on the planetary surface.

Small ground bases are those covered in (R1.14), (R1.28), and possibly others in future products.

Medium ground bases are simply a larger version of the small ground bases and use the same rules.

In the case of bases on planets, certain modifications apply.

**(P2.71) INTERACTION WITH UNITS:** Units and planetary bases require special rules when they interact.

**(P2.711)** Units that are able to land on planets can dock at the ground base by landing at the appropriate planetary hex side. No tractor beam (C13.0) is required. Units unable to land cannot dock at ground bases. Units which dock at a ground base can be repaired by it (within the rules).

**(P2.712)** A ground base (not a unit that has landed) can tractor a unit (G7.25). Actually pulling an enemy unit down to the planet's surface (resulting in a crash if the unit is not capable of planetary landings) is possible, but takes much longer than a scenario. [A friendly unit could be lowered by a base using rotation; see (G7.7) or (P2.442).] Therefore, a unit held in a tractor by a ground base cannot be pulled into a planetary surface hex during a scenario. If the unit is unable to break the tractor beam before the end of the scenario, it is assumed to be captured or destroyed (option of the unit's owner) after the scenario is over. The unit must have at least one auction opportunity during an Energy Allocation Phase, even if the scenario must be extended one complete turn. If the unit crashes, the base player will ensure that this takes place in a remote area. If the player owning the unit wants the effect of the unit's destruction, he will have to self-destruct during the scenario. This applies to a unit with operating engines expending at least one point of power for movement.

**(P2.713)** Seeking weapons can be fired at a ground base using ballistic targeting (F4.0), but only from a range of 4 hexes or less. Weapons fired in this manner cannot be distracted by ECM or WW. Weapons fired ballistically at ground targets do explode on impact. Weapons cannot be fired for ballistic bombardment under passive fire control (D19.0) as target tracking is inadequate. Submunitions from a ballistic MW drone cannot target a ground base.

**(P2.72) WEAPONS:** The weapons of a ground base have special rules.

**(P2.721)** Large ground bases (being based on orbital designs) require modified firing arcs. All of the large ground base's weapons have a 180° firing arc; see (P2.62). Small and medium ground bases (which cannot be placed in orbit) are designed with 180° firing arcs (R1.14).

**(P2.722)** Ground bases of all types ignore the effects of atmospheres [see (P2.51) and (P2.54)] when firing energy-using direct-fire weapons. See also (P2.53).

**(P2.73) DEFENSES:** The shields of a ground base use special rules.

**(P2.731)** The shields of a large ground base (i.e., an orbital base placed on a planetary surface) are modified. Starbase armor is combined if on a planet.

A base in a hex with two non-planet hex sides [for example hex 1225 in the illustration in (P2.62)] would have two shields, each of which is three times the normal strength.

A base in a hex with three non-planet hex sides [for example hex 1223 in the illustration in (P2.62)] would have three shields, each of which is two times the normal strength.

In each case, the shield section on that side provides protection from attack from the adjacent planetary hex side.

The small and medium ground bases (P2.76) have a single shield (covering all arcs) as part of their design.

**(P2.732)** A ground base could use a wild weasel to distract seeking weapons [except those using ballistic targeting, see (P2.713)]. The WW remains in the hex of the ground base. Otherwise, it is treated as a WW launched by any other base (e.g., collateral damage).

**(P2.733)** Enveloping weapons require special treatment. In the case of a large asteroid, the "enveloping" damage counts toward destruction (P3.45).

**(P2.7331)** Hellbores and enveloping plasma torpedoes try to envelop the base, but obviously cannot envelop the entire planet. Their effect is divided into two equal portions. The first is lost [expended on the surrounding landscape (P2.525)]; the second is divided equally over the base's shields. Any odd point is expended against the ground.

**(P2.7332)** The splash elements of PPDs are lost when fired at small and medium ground bases (which only have one shield). When a PPD is fired at a large ground base with three shields, the normal rules are used (except that if the main pulse hits either of the flank shields, one splash element would obviously be expended on the ground). Any "lost" splash elements could be counted for general planetary devastation (P2.525).

**(P2.734)** Ground bases can be targeted by warp-seeking (type-VI) drones as any base in space could; damage is as per size class of target.

**(P2.735)** Ground bases cannot project an ESG field beyond a radius of zero. (The planet would block a part of a radius 1 or greater field; the remainder would not be stable.) See (P2.546) and (G23.652) for the effects of an atmosphere.

**(P2.736)** Ground bases can use special sensors (G24.0) and ECM and ECCM (D6.3) normally. Ground bases get the benefit of (P2.51) but are not penalized by it (P2.722). Ground bases do not get the ground clutter bonus of (P2.52) and are not penalized by (P2.53) or (P2.54) [exception: they are penalized by (P2.548)]. Seeking weapons launched by ground bases are treated under (P2.85).

**(P2.74) ADDITIONAL INFORMATION:** Ground bases are under the following additional restrictions.

**(P2.741)** A ground base cannot cloak. (Ships on the ground can cloak; the enemy has not had time to locate them.)

**(P2.742)** Ground bases cannot perform any form of movement and cannot rotate.

**(P2.743)** The BPV cost of large ground bases is equal to bases in space.

**(P2.744)** Ground bases cannot be displaced (G18.72) or placed in stasis (G16.61).

**(P2.745)** Monsters ignore ground bases unless those bases attack the monster. Thereafter, the monster treats a ground base as a unit. Scenarios may give exceptions to this rule, e.g., (SM4.45) or (SM5.48).

**(P2.746)** Ground bases can self-destruct. Explosions resulting from self-destruction or destruction in combat can be resolved using (D5.0) and (P2.547), in addition to which any ground troops fighting at that base would be destroyed.

**(P2.747)** Small and medium ground bases can be placed on large asteroids (P3.4), in which case they would have 360° weapons and their shields would cover the entire 360° arc. Large bases cannot be placed on large asteroids (although of course they can be placed in asteroid hexes). Players may place the bases on a hex side of the large asteroid, limiting the arc into which it can fire (and from which it can be hit) to 180°; see (P3.43).

### **(P2.75) INTERACTION WITH MARINE UNITS**

These rules concern ground assaults. Normal boarding assaults work as on ships (transporters through down shields, etc.).

**(P2.751)** Troops (militia, ground troops, boarding parties) could attack the base on the ground. These units would first have to move to the base [which is treated as a ground combat location (D15.1)] by ship, shuttle, or transporter. They can then attempt to "board" the base through the "repair" areas on the (D16.0) combat display by the procedure in (P2.752).

**(P2.752)** The procedure for ground starbases and ground battle stations is as follows: Each unit attempting to gain entry to the ground base is resolved separately. Roll one die, modify the result as listed below, and use the chart to determine the fate of that unit.

- 1-2 = Unit gains entry
- 3 = Unit does not gain entry
- 4-6 = Unit is destroyed

Subtract one from the die roll if attacking units already control the "weapons" area adjoining the "repair" area being entered.

Subtract three from the die roll if attacking units already control the "weapons" area adjoining the "repair" area being entered AND the

"weapons" areas of both adjacent modules. (These two modifiers are not cumulative.)

Subtract one from the die roll if the assault forces includes a legendary marine major or legendary ground forces officer (G22.0). Add one if the defenders include a legendary marine major or legendary ground forces officer. This shift is cumulative with those above.

See also (G21.141) and (G21.241) for additional modifiers.

**(P2.753)** The procedure for ground base stations is the same as (P2.752) except that the attacking units enter through the "pod" areas and must control these "pod" areas to modify the die roll.

**(P2.754)** Small orbital bases [system stations (R1.30), mobile bases (R1.24), and commercial platforms (R1.29)] deployed as surface bases have only three areas (the core and the two modules). Using the (P2.752) procedure, entry is through the modules with an automatic -1 modifier; if the core is controlled, further entry is automatically successful.

**(P2.755)** Small (and medium) ground bases (P2.76) have only one area. Entry has an automatic -2 modifier in the (P2.752) procedure.

**(P2.756)** While personnel units could leave the base on foot, they would be very limited in speed and could not escape from the area (i.e., the effect of weapons aimed at the base) within the course of a scenario. Personnel units leaving by ship, transporter, or shuttle are covered under the rules for moving those units.

**(P2.76) SMALL GROUND BASES:** Certain small ground bases covered in (R1.14), (R1.28), and (R10.31) have additional benefits and conditions. Note that medium ground bases use the same rules as small ground bases; they are simply larger.

## **(P2.8) ATMOSPHERIC MOVEMENT**

**(P2.80) GENERAL:** A unit can only be in an atmosphere hex if it is conducting atmospheric flight (which requires one point of movement power per turn even if the unit does not move) or if they are using one of the landing systems in (P2.43). Otherwise, a unit in an atmosphere will crash (P2.431).

**(P2.81) MAXIMUM SPEED:** Units can move in atmosphere hexes without landing. The maximum speed in an atmosphere is one hex-side per turn. It is simply impossible to go any faster. The maximum speed that can be paid for and/or used is one hex per turn. A unit entering an atmosphere hex must do so by (P2.423) or by (P2.41).

**(P2.811)** A unit leaving an atmosphere hex to enter a space hex is not restricted except by acceleration limits or other rules.

**(P2.812)** A unit which enters an atmosphere or planet hex at a speed greater than one crashes. The extent of the crash depends on the type of planet:

Class-M (P2.212) crash landing (P2.431).

Gas giant (P2.222) catastrophic landing (P2.435).

Moon (P2.231) possible crash landing (P2.431).

**(P2.813)** The normal turn modes and sideslip modes do not apply to atmospheric movement. See (P2.86).

**(P2.82) ERRATIC MANEUVERING** is prohibited in an atmosphere; (C10.24).

**(P2.83) UNRESTRICTED MANEUVERS:** There is no additional restriction on performing tactical maneuvers (C5.0), emergency deceleration (C8.0), or HETs (C6.0) in an atmosphere. Such maneuvers are legal in that environment unless otherwise restricted.

A ship which ends its movement in an atmosphere hex with emergency deceleration (C8.414) is allowed to expend the one point of power required by (P2.80). This one movement point would have to come from reserve power.

**(P2.84) WILD WEASEL:** If a WW is plotted to enter an atmosphere hex, it slows to a speed of one, enters the atmosphere by (P2.41), and continues its plotted course via atmospheric flight (P2.80). It does not land or crash, but will attempt to maneuver around the planet (through the atmosphere) until it can resume its original course. The WW takes the shortest path around the planet that will return it to its programmed course. If the two options are equal, roll a die with 1-3 meaning clockwise and 4-6 meaning counter clockwise. In the case of an airless planet or moon, use (P2.231).

**(P2.85) SEEKING WEAPONS:** Seeking weapons launched from a planetary surface move one hex when their speed first calls for movement. If this takes the weapon into a non-atmosphere hex, it moves normally thereafter. If not, the weapon stops and repeats this procedure on the next turn.

**(P2.851)** Drone range is based (in this case) on the actual number of hexes moved. Calculate the range by multiplying the speed in hexes by the endurance in turns, then subtract the hexes spent moving in the atmosphere.

**(P2.852)** Plasma torpedoes use this procedure, counting each atmosphere hex (including the one they were launched in, even if the target is in that hex) as five hexes of their range for warhead strength and range determination. Bases armed with plasma torpedoes are seldom put on planets with atmospheres.

**(P2.853)** Seeking weapons will not enter atmosphere hexes unless their target is in that atmosphere. A weapon will remain outside of the atmosphere as long as possible before entering it to pursue the target.

**(P2.8531)** If the target is a ground unit (or a landed unit), the seeking weapon will enter the unit's hex on one turn and strike it in Impulse #1 of the next turn.

**(P2.8532)** If the target is in an atmosphere hex (or in the upper layer of a two-layer atmosphere), the weapon will maneuver until it can enter that hex, at which point it will strike the target immediately.

**(P2.8533)** If the target is in a lower-atmosphere hex, the weapon will maneuver until it can enter an adjacent hex, at which point it will stop and begin atmospheric movement (one hex per turn on Impulse #32) until it strikes the target (or the target leaves the atmosphere and the weapon can also do so).

**(P2.86) SHIELDS, FIRING ARCS:** A unit flying in an atmosphere has some of its shields and weapons arcs blocked. Just which ones depend on what maneuvers it has made.

**(P2.861)** Units in the upper hex of a two-hex-deep atmosphere have their normal facing.

**(P2.862)** Units which enter an atmosphere/surface hex have, for the remainder of the turn, their normal facing for entering that hex.

**(P2.863)** Units which are in an atmosphere hex side without landing may, on Impulse #32 of each turn, change their facing to any direction they wish. They will then have the 180° firing arcs (which also define what units can fire at them) provided by (P2.62).

## (P3.0) ASTEROIDS

Asteroid belts are common navigational hazards and are portrayed in *STAR FLEET BATTLES* by these rules. Asteroid counters are provided in the game.

The rings of gas giants (P2.223) are treated as asteroid hexes with certain modifications.

Eighteen asteroid counters are provided with Basic Set. More are found in some other products. These are used as per (P3.1). Maps portraying an Asteroid Belt, an Asteroid Field, and the gap in a large and dense asteroid field known as Blackfoot Pass, are included in Captain's Scenario Modules.

### (P3.1) LAYOUT OF AN ASTEROID FIELD

**(P3.11) LAYOUT:** Unless different procedures are specified in the scenario, use this system to set up an asteroid field. Place one asteroid counter in each of the following hexes: 0505, 0713, 1007, 0522, 0730, 1024, 1905, 2113, 2407, 1922, 2128, 2424, 3322, 3513, 3807, 3305, 3528, and 3824. Roll one die for each counter and move it in the indicated direction one hex. This establishes the position of the asteroid counters.

**(P3.12) DEFINITION:** All hexes within two hexes of an asteroid counter are assumed to contain asteroids and are referred to as asteroid hexes. Hexes within the specified radius of two or more asteroid counters do not have "double asteroids" but are the same as other asteroid hexes.

### (P3.2) EFFECT OF ASTEROIDS ON MOVEMENT

For every asteroid hex entered by a ship, seeking weapon, or shuttle, a die must be rolled to see if a collision has taken place. The chart below gives the results in terms of hit points on the shields.

ASTEROID COLLISION DAMAGE TABLE				
DIE ROLL	SPEED			
	1-6	7-14	15-25	26+
1	0	0	0	0
2	0	0	0	5
3	0	0	3	10
4	0	2	6	15
5	0	6	10	20
6	0	10	15	30

Ships entering asteroid hexes, even if they are Tholians and are "riding a web", roll for asteroid damage normally.

A unit that is rotated by (G7.7) is treated for purposes of rolling for asteroid (P3.2), ring material (P2.223), or dust (P13.0) damage as if it was moving at the effective speed that resulted from the ships announced speeds. Shuttles rotated using (J1.621) roll for damage based on the effective speed of the ship that is attempting to land them.

Optional: The ring material chart in (P2.223) could be used for a "sparse" asteroid field if the players so choose.

**(P3.21) DIRECTION:** If the ship is moving forward, the #1 shield is damaged; if the ship is moving in reverse, the #4 shield receives the damage. Sideslips (C4.0) have no effect on this determination. A tumbling ship (C6.55) will take damage on the shield facing the hex entered.

**(P3.22) SPECIAL MANEUVERING CASES:** Certain conditions produce die roll modifiers for the table in (P3.2). A result of more than 6 is treated as 6; a result of less than 1 is treated as 1. Column shifts are independent of these die roll shifts.

**(P3.221) NIMBLE UNITS** (C11.21) subtract one from the die roll when rolling for asteroid damage. A final result of less than one is considered to be one.

**(P3.222) ERRATIC MANEUVERING:** Units using EM (C10.45) use the next higher column on the damage chart. Add the EM energy to the speed rather than going to a higher column.

**(P3.223) CREW, OFFICERS:** Outstanding crews subtract one from the roll on the asteroid damage table (G21.228), legendary navigators reduce the collision chance by one column (G22.812). Poor crews add one to the die roll to determine how much asteroid damage is received (G21.128).

**(P3.23) FOLLOWING:** A unit could launch a drone, plasma torpedo, or shuttle and follow it into the asteroid hex. Also, one unit could follow another, or one weapon could follow another. This is under certain restrictions. The maximum column length is two hexes (including the hex of the leading unit, "following" units could be in either hex).

**(P3.231)** The following units in the "column" must be "friendly" toward each other, either in the same hex or adjacent hexes, and following the same path. Seeking weapons must all be targeted on the same target.

**(P3.232)** Units using this procedure cannot perform EM (C10.45).

**(P3.233)** When several units of a "column" in a single hex are entering the next hex in the "path," the order that the units are entering the asteroid hex is announced before any move and only the first unit rolls for possible damage. All following units receive no damage. If the first unit is destroyed, the next unit must roll for possible damage in that hex. This may create exceptions to the Order of Precedence (C1.313). When going through the Order of Precedence, whenever you encounter a unit which has not moved that impulse AND which is part of a column, consult the Columnar Order for that Column and (at the current point in the Order of Precedence) move any units which are earlier in the Columnar Order for that Column. If a unit (voluntarily or involuntarily) leaves a column, some, all, or none of the subsequent units in that Column may leave the original Column and join the new Column, but the units in both columns will keep their original Columnar Order for the rest of the present impulse. Units can be attached to or detached from a given column at any point and are automatically detached if not in adjacent hexes at the end of any movement segment. The basic order can be changed every impulse as above.

**(P3.234)** Wild weasels are treated as the ship they are simulating (J3.0). The WW does not get the nimble bonus a shuttle would normally receive unless the ship it is simulating is also nimble. However, the WW is destroyed when it receives enough points to destroy the shuttle, not the ship it is simulating.

**(P3.235)** Non-nimble units cannot follow nimble units (C11.21) unless the nimble units give up their nimble bonus.

**(P3.24) PLASMA TORPEDOES:** Asteroids will damage plasma torpedoes. (They are one of the few non-phaser items that will.) In this case, the chart would yield "phaser hits" that would be treated as in (FP1.61). Plasma torpedoes can follow or lead other units (P3.23).

A PPT moving through asteroids will take damage (and possibly be destroyed) as a real torpedo would. However, anything following this PPT would not be protected from damage by the PPT (and rolls for damage if the PPT was "damaged"). The PPT does not actually suffer the damage, but calculates what damage it would have taken (had it been real) and adjusts its electronic signature to this calculated level.

**(P3.25) CLEARING A PATH:** Any unit may fire its weapons into an asteroid hex that it is about to enter for the purpose of clearing a path and reducing the damage resulting from rapid movement through such hexes. Note that this is completely different from firing a weapon through an asteroid hex at another unit. Any weapon can be used for this purpose. Note that due to the Sequence of Play the weapon is actually fired on the previous impulse; the benefit is lost if the firing unit enters any other hex before entering the hex into which it fired. The target applies only to the first subsequent entry into that hex. The target asteroid hex does not provide itself any ECM benefit, but hexes fired from or through will. The fire will have no effect if not on the impulse immediately prior to entry.

**(P3.251)** Each point of damage scored on an asteroid hex will reduce the amount of damage to the unit resulting from entering that hex by one point. Note that the amount of damage to the unit is highly variable, and since all fire into an asteroid hex must be conducted during previous impulses, the player will not know until entering the hex and rolling a die if the fire was actually necessary or beneficial.

**EXAMPLE:** A cruiser fires a phaser-1 into an asteroid hex and scores 8 points of damage to the asteroids. On the next impulse, the unit enters the hex and rolls for asteroid damage. The die roll

indicates 10 points of damage. This is reduced to 2 by the phaser fire. The cruiser then fires a second phaser into the next hex on his intended path and scores 4 points of damage to the asteroids. Entering the hex on a later impulse, the die is rolled and indicates no asteroid damage. The second phaser was thus wasted. There is no carry-over to other hexes.

**(P3.252)** Seeking weapons could be used to lead a unit through the asteroid hex (P3.23) or could be targeted on a specific asteroid hex. The seeking weapon does not take asteroid damage before exploding. A Kzinti ship, for example, could fire four drones, targeting each of them onto a different hex of its intended course through the asteroid field. [Those that pass through an asteroid hex to reach their targets might be damaged by it (P3.2).] This tactic has a side effect of broadcasting your intended course to your opponents. It can also be used to deceive opponents as to your intended course.

**(P3.253)** One unit cannot fire direct-fire or seeking weapons at asteroids to clear a path for another unit.

**(P3.254)** Units cannot perform EM (C10.45) while using weapons to reduce the effect of asteroids.

**(P3.255)** Some types of "weapons" cannot perform this asteroid clearing function. These include ADDs (E5.32), PPDs (E11.0), ESGs (G23.651), displacement devices (G18.0), and SFGs (G16.0).

**(P3.26) LEAVING AN ASTEROID HEX:** A unit takes no damage from asteroids for the act of leaving an asteroid hex. Hence, a seeking weapon launched in an asteroid hex [and a unit displaced (G18.65) into an asteroid hex] would suffer no asteroid damage if it were able to move into a non-asteroid hex on its next movement.

### (P3.3) EFFECT OF ASTEROIDS ON COMBAT

The presence of several million tons of rock (broken into pieces of various sizes) can have various effects on combat. See (G24.183) for effect on special sensors.

**(P3.31) LOCK-ON:** Asteroids do not affect lock-on.

**(P3.32) SEEKING WEAPONS** passing through asteroid hexes may be damaged by the asteroids (P3.2). If fired in the same hex as their target, they do not take damage unless they leave the hex and move into another asteroid hex.

**(P3.33) ELECTRONIC WARFARE:** Each asteroid hex between the firing unit (or the unit guiding seeking weapons, or the unit attempting to use tractors, transporters, etc.) and the target provides to the target the benefit of one point of ECM. This includes the firing unit's hex and the target's hex (1 hex if both are in the same hex). Note that this is ECM, not range. This is regarded as natural ECM (D6.3143). Fire that passes along the hex side between two asteroid hexes counts only one of those two hexes for ECM. This can be countered by ECCM.

**(P3.34) WEBS:** Asteroids make good anchor points for webs (G10.1314) [and particularly for web casters (E12.544) and (E12.211)], making an asteroid field a very bad place to encounter a Tholian. (You will probably not see home again.)

**(P3.35) TACTICAL INTELLIGENCE:** Asteroids have an effect on tactical intelligence. See (D17.2251) and (D17.26).

**(P3.36) SIZE CLASS:** For purposes of being fired at, all asteroids are considered to be size class four or larger targets.

### (P3.4) LARGE ASTEROIDS

Most asteroid hexes are filled with dust, small pebbles, a few large rocks, and the occasional boulder. A relatively few "large asteroids" (up to a mile in diameter) exist. Only one small or medium ground base can be placed on any given large asteroid, no bases may be placed on small asteroids. Special scenario rules might define an exception for a really large asteroid.

**(P3.41) LOCATION:** Generally, one such large asteroid will be in the same hex as the asteroid counter (P3.1) or in the center hex of each cluster on the Asteroid Field map in Module B (for example in hexes 3304, 3207, 3311, 3905, 3908, 3607, and 3714 on Panel C). Alternatively, these may be specified by the scenario rules.

**(P3.42) LANDING:** All units may land on large asteroids. The procedure is simplified by the lack of atmosphere (and any significant gravity). The unit simply ends its movement in the hex with the asteroid and "lands" on the next turn using the docking procedures in (C13.9).

**(P3.43) EFFECT:** Units (e.g., ships) landed on large asteroids have their normal facing, firing arcs, etc.

**(P3.431)** The asteroid will, however, block one shield arc (of the owner's choice, which is announced upon docking and which cannot be changed without redocking) from receiving any damage. No weapons can be fired or launched through that shield.

**(P3.432)** The unit cannot have a lock-on to any unit within the blocked shield arc, cannot use transporters or tractors through that arc (except to or from the asteroid itself), cannot be locked onto by any unit in that arc, cannot conduct tactical intelligence observations (or be observed) through that arc, and cannot move.

**(P3.433)** The unit can still be detected and located through the blocked arc if its fire control is active.

**(P3.434)** Such asteroids cannot be towed within the context of a scenario. (They have a movement cost of 1000+ and might be moved over many turns. Impulse power cannot be used to tow something this large.)

**(P3.44) SMALL BASES** are often built on large asteroids; see (P2.76) and (P2.747).

**(P3.45) DESTRUCTION:** Large asteroids can be fragmented by 400 points of damage. This will destroy any base built on the asteroid or any ground troops deployed on the asteroid.

**(P4.0) BLACK HOLE**

One of the most treacherous navigational hazards in space is a "black hole" (or hypermass), a star that has collapsed inward until its matter is so dense (and hence, its gravity so great) that even light cannot escape. Within *STAR FLEET BATTLES*, the effect of a black hole is to make all units move toward a designated hex (where the black hole is located) on certain impulses, even if the units do not wish to do so. They are being pulled toward the black hole hex by powerful gravity forces.

Mark the location of the black hole with an upside down counter. A counter is provided in Module R1 for the black hole.

A map portraying the zones of gravity around a black hole is included in Captain's Module B.

**(P4.1) PROCEDURE**

Movement in response to a black hole is governed by the chart below. During the specified impulses, all units (including cloaked units) within the specified range are moved one hex closer to the black hole hex. This is done during the Involuntary Movement Stage. The units are moved in order of those closest to the black hole first and proceeding outward. Units at the same range are moved simultaneously (B2.4).

IMPULSES	RANGE
Every	2 hexes
2, 5, 8, 11, 13, 16, 19, 22, 24, 27, 29, 32	5 hexes
5, 11, 16, 22, 27, 32	10 hexes
11, 22, 32	20 hexes
32	30 hexes

**(P4.11) PROCEDURE:** During each of the stated impulses, all units within the stated range are moved one hex closer to the black hole hex. For example, a unit nine hexes from the black hole hex would be moved one hex toward it during both the 5th and 11th impulses (and several others) of the turn. If there is a choice between two hexes, the owning player of each unit makes the choice.

If a unit is moved by the Black Hole, any units to which it is linked by tractor beam will also be moved. If two units linked by a

tractor beam are pulled in different directions on the same impulse by two different Black Holes, each ship is moved independently. If the ships move farther apart, the ship generating the tractor beam may have to apply more energy to maintain it at the new range. If insufficient energy is available to maintain the tractor beam at the new range, or if the range exceeds the maximum limit for tractor beams (usually three hexes), the link is broken.

**(P4.12) FACING:** Movement by a black hole does not change the unit's facing.

**(P4.13) STABILIZERS:** Units with active stabilizers (G29.27) cannot be moved by a black hole.

**(P4.14) MINES** are moved by black holes (M2.21).

**(P4.2) EFFECT OF A BLACK HOLE**

**(P4.21) ENTERING A BLACK HOLE:** Any unit entering the hex of a black hole is immediately destroyed. This results in a burst of radiation equal to the explosion force of the unit as calculated in (D5.2); note that some smaller (size 6 and 7) units do not generate explosions. This burst is resolved by (P5.2) below. Note that mines which fall into a black hole are size class seven objects and will not trigger a radiation burst, or even explode.

**(P4.22) SEEKING WEAPONS** are affected by (P4.1) above. Additionally, if the target is within 10 hexes of the black hole, it gains the benefit of two points of ECM. This is not cumulative with (P4.24).

**(P4.23) DIRECT-FIRE WEAPONS** cannot be fired if the line of sight (the direct line between the center of the firing unit's hex and the center of the target's hex) passes within two hexes of a black hole. See (D17.151).

**(P4.24) ELECTRONIC WARFARE:** If the line of sight passes within 10 hexes of the black hole, the target gains the benefit of two points of ECM. This is not cumulative with (P4.22).

**(P4.25) INVIOABILITY:** A black hole cannot be put in stasis (G16.61). A black hole cannot be displaced (G18.72).

**(P4.26) ESG:** An expanding sphere cannot be generated into a hex within five hexes of a black hole. In this case, an ESG works as it would with a web (G23.85).

**(P4.27) TRANSPORTERS:** Transporters (G8.0) cannot be used through or along the edge of a black hole hex.

**(P4.28) DISENGAGEMENT:** No unit can disengage (C7.0) when within 10 hexes of a black hole or when a black hole is in its FA firing arc and within 100 hexes. A unit cannot disengage by sublight evasion (C7.36) if within 30 hexes of the black hole.

**(P4.29) GRAVITY WAVES:** Some Black Holes produce gravity waves (P9.4).

**(P5.0) VARIABLE PULSAR**

Another major menace to navigation is the variable pulsar, which periodically emits a burst of hard sub-space radiation, causing major damage to all units in the area. If a pulsar is called for in a scenario, it is placed into a specific hex. If used in a scenario designed by the players, it should be assigned a specific hex.

**(P5.1) PROCEDURE**

The pulsar emits a burst of radiation during a randomly selected Impulse Activity Segment (Annex 2) of a randomly selected turn.

**(P5.11) TURN SELECTION:** The pulsar automatically emits a burst on the first turn of the scenario. After each burst, roll one die to determine how many turns later the next burst will occur. A result of "1" indicates that the next burst will be on the immediately following turn.

**(P5.12) IMPULSE SELECTION:** At the first of each turn during which an outburst is scheduled to occur, roll six dice and total the results. A result of: 33 is considered to be 2; 34 is considered to be 3; 35 is considered to be 4; and 36 is considered to be 5. The final result is the impulse on which the pulsar emits its outburst. Thus, the outburst cannot happen on the first impulse.

**(P5.13) REGULAR PULSAR:** These rules cover a randomly-variable pulsar. It is, of course, entirely possible that the pulsar in question is regular, rather than variable, in its cycles. (Such a decision is up to the players; the pulsar is variable unless they decide otherwise in advance.) Since this effect can be tracked from considerable distances, the length of each cycle (in impulses) is well known in advance. It should be selected randomly (the total of several dice is suggested, or take the average of the last two digits of the birth years of all the players), and thereafter the outbursts will occur regularly at that interval (in impulses). In all other ways, a regularly-variable pulsar acts as a randomly-variable pulsar.

**(P5.2) EFFECT OF THE PULSAR**

The pulsar has a base strength (determined below) which is reduced with range from the pulsar.

**(P5.21) BASE STRENGTH:** Each time the pulsar emits an outburst, roll one die and multiply the result by 10. This is the base strength of the pulsar.

**(P5.22) RANGE EFFECT:** The distance from the pulsar to each target has an effect on the strength as follows:

0-5 hexes	=	100% strength
6-10 hexes	=	75% strength
11-20 hexes	=	50% strength
21-50 hexes	=	25% strength

**(P5.23) DAMAGE:** Each (and every) unit within 50 hexes of the pulsar receives a number of damage points equal to the appropriate percentage of the base strength. These are scored on the shield facing the pulsar (assuming that the unit has shields).

Units without shields are damaged directly.

When calculating the amount of damage, round fractions of 0.499 down and those of 0.500 up.

Mines will not be damaged by a pulsar (M2.22).

Each 12 points of damage blinds one powered scout channel (G24.133).

**(P5.3) OTHER EFFECTS**

**(P5.31) NO EFFECT:** Cloaking devices, wild weasels, SWACs, stealth, and EW will not protect a unit from the effects of the pulsar. (Nothing will unless it is specifically described as doing so.)

**(P5.32) DIRECT-FIRE WEAPONS** cannot be fired into or through a pulsar hex.

**(P5.33) PLASMA TORPEDOES:** Plasma torpedoes (and PPTs) are affected by pulsars. Damage to a plasma torpedo is treated the same as damage from phaser fire.

**(P5.34) ENTERING HEX:** Any unit entering the hex of a pulsar is destroyed.

**(P5.35) OTHER EFFECTS:**

**(P5.351)** No unit can disengage (C7.0) when within 10 hexes of a pulsar or when a pulsar is in its FA firing arc and within 100 hexes.

**(P5.352)** A pulsar cannot be put in stasis or displaced. See (G16.61) and (G18.72).

**(P5.353)** Transporters cannot be used through or along the edges of a pulsar hex.

**(P5.354)** Planets (P2.5472), and to a lesser extent webs (G10.751), will block the effects of a pulsar.

**(P5.355)** Pulsars have the same EW effects as a black hole (P4.24). The penalty in (P4.24) also applies.

**(P6.0) NEBULAE**

Large gas clouds are located in various parts of the galaxy. These have various effects, which are reflected by these rules. The gas clouds are highly charged with electrical power and swept by turbulence. Ships can generate (and use their built-in) EW normally, but because scout functions do not work, EW cannot be lent except for self-defense jamming.

**(P6.1) SIZE:** Nebulae are several maps across. Thus, if a given scenario is to take place within a nebula, the entire map will be considered to be inside the nebula and units will be unable to leave the nebula. Players could assume that their battle is at the edge of a nebula and define that edge with upside down counters or simply note the hex row.

**(P6.2) ELECTRONIC WARFARE:** All units within a nebula automatically have nine points of ECM provided by it.

**(P6.3) SHIELDS:** Shields only function at minimum level in a nebula. Specific shield reinforcement cannot exceed five points per shield; general reinforcement cannot exceed five shield points total. The five-point limits are at any given time. As points are used, additional points can be added.

**(P6.31)** Each PA panel BOX receives one point of energy (equivalent to damage) on the 8th and 24th impulse of each turn (in the Involuntary Movement Step). Energy discharge is normal. PAs cannot be operated at reinforced levels inside a nebula. As with shielded units, nebula damage cannot produce internal damage. If a panel is full, it does not suffer additional damage or allow nebula damage to enter the unit.

**(P6.4) SMALL UNITS:**

**(P6.41)** Fighters and shuttles are automatically destroyed if launched inside a nebula or if they enter one.

**(P6.42)** Wild weasels are destroyed before they can begin to function.

**(P6.43)** Drones fired inside a nebula function normally [other than warp-seeking drones (FD5.1), which cannot be used]. See (P6.73).

**(P6.5) RANDOM MOVEMENT:** During the Movement Segment of Impulses #5, #15, and #26, all units (including seeking weapons) are moved one hex in a random direction (determined by die roll; use the arrows around hex 0328) and may have their facing changed to a new direction (determined by die roll). This random movement does not affect turn or sideslip modes.

The die roll for change of facing is as follows:

- 1-2 = 60° Left
- 3-4 = No Change
- 5-6 = 60° Right

Seeking weapons are unaffected by change of facing die rolls.

A ship with a legendary navigator (G22.84) ignores the random effects on Impulses #5 and #26.

Players could elect to play in a "quiet nebula" which does not cause the (P6.5) effects.

**(P6.6) NON-FUNCTIONAL SYSTEMS:** The following systems will not function at all within a nebula: chaff, tractor beams, transporters, webs, cloaking devices, stasis field generators, EW lending (including ECM drones), expanding sphere generators, displacement devices, scout functions, mines, ATG, and dogfight drones. Andromedan TR beams cannot be used as tractor beams (E9.42), but otherwise operate as any other heavy weapon in a nebula. Note that EW generated by a ship or that is natural to the unit operates normally in a nebula. Note that scout functions operate normally outside the nebula, but can have no DIRECT effect on anything inside a nebula, see (G24.1852).

**(P6.7) DEGRADED EFFECTS:** Many systems are degraded when operating inside a nebula.

**(P6.71)** When calculating the information received by labs, add three to the true range to determine the effective range.

**(P6.72)** Probes (fired as weapons or for information) have a maximum range of two hexes. There is no effect on the die roll to score a hit.

**(P6.73)** Drones traveling within a nebula receive 1/4 point of "phaser damage" for every hex entered. Plasma torpedoes receive 1 point of "phaser damage" (1/2 point of warhead reduction) for every hex entered.

**TERRAIN RULES IN OTHER PRODUCTS**

**(P7.0) WYN RADIATION ZONE:** The WYN Star Cluster can only be entered by passing through this zone, which temporarily degrades certain systems on ships, leaving them nearly crippled when they face the WYN Defense Forces. Module C1.

**(P8.0) STANDARD ORBITS:** Movement around planets. Advanced Missions.

**(P9.0) GRAVITY WAVES:** These sweep across the map, damaging and even redirecting ships. Advanced Missions.

**(P10.0) HEAT ZONES:** These areas damage ships without shields. Also includes rules for White Dwarf Stars. Advanced Missions.

**(P11.0) SUNSPOTS:** These interfere with targeting and communications. Advanced Missions.

**(P12.0) SUPER NOVA:** These destroy any ship they can catch. Advanced Missions.

**(P13.0) DUST CLOUDS:** A very very weak asteroid field, provides ECM, minor damage, and degrades various systems. Advanced Missions.

**(P14.0) ION STORMS:** These combine the effects, of Radiation Zones, Gravity Waves, and Sunspots. Advanced Missions.

**(P15.0) RADIATION ZONES:** These cause crew casualties on unshielded units. Also includes rules for Neutron Stars. Advanced Missions.

**(P16.0) COMETS:** A combination of a large asteroid with a "tail" composed of dust hexes. Reserved for a later product.

**(P17.0) TOURNAMENT BARRIER:** Used to keep ships in "the arena" for tournament duels (which otherwise would last days instead of hours). Module T.

**END OF SECTION (P0.0) BASIC SET**



**(R0.0) SHIPS AND OTHER UNITS**

STAR FLEET BATTLES includes literally hundreds of ships, and more are being added continually through modules, Captain's Logs, Starletter, etc. Basic Set includes several dozen ships.

**(R0.1) RULE NUMBERING**

This rules section is numbered somewhat differently from the other sections. Each race is assigned a number (for example, the Federation is "R2"), and each ship is assigned a consecutive number within that series. Note that (R2.13) is not the third minor point concerning (R2.1) as it would be in other rules sections, but is the 13th Federation ship. The consecutive numbering of the starships within each race is, with some exceptions, the order in which the ship was introduced to the game, not the order of size or importance.

In cases where it is necessary to subdivide a rule on a given ship class, letters are used. Thus, (R1.1) deals with starbases, and rules (R1.1A) and (R1.1B) are subdivisions of that rule.

Ships are numbered consecutively within the section.

Fleet refits are assigned numbers starting with (R#.R1).

Fighters are assigned numbers starting with (R#.F1).

Fast patrol ships are assigned numbers starting with (R#.PF1)

**(R0.2) COMMANDER'S SSD SHEETS**

The SSD sheets provided with all Captain's Edition products are of the type known as "Commander's SSDs" which include all relevant charts. This will greatly reduce the need to reference the rulebook when playing. Also, each of these special SSD sheets includes check off boxes for crew units, boarding parties, ammunition, etc.

On SSDs, fighter boxes marked = are drone, plasma-D, or fusion-armed fighters. Fighter boxes marked + are disruptor, hellbore, or photon-armed fighters. The "BD" Boxes are used to record if the ship has broken down one or more times.

**(R0.3) DEFAULT VALUES**

Unless specifically stated otherwise in the unit description:

1. Accelerates by 10 or to double its current speed, whichever is greater.
2. Has no drone or plasma-D storage for use by fighters.
3. Has one set of reloads for its drone racks (if it has drone racks).
4. Can fire one drone per drone rack per turn (if it has drone racks).
5. Can control a number of seeking weapons equal to its sensor rating if it is armed with seeking weapons and half of the sensor rating if not so armed (F3.211).

**(R0.4) DESCRIPTION OF SHIP CLASSES**

Ships in this game come in a variety of classes that are, to a large extent, standardized throughout all races. A general description of these classes and their assigned role is given here.

The standard ship of all fleets is the HEAVY CRUISER (or CA). This ship is large and powerful enough for virtually every mission except fighting a dreadnought. These ships are used for routine patrols of the frontier and interior. They are large enough to have a full range of equipment, yet small enough to be operated efficiently. Some heavy cruisers are fitted with increased weapons and command facilities and are called COMMAND CRUISERS. These are used to command fleets and independent squadrons.

The smaller and less powerful LIGHT CRUISERS (CL) conduct much the same missions as heavy cruisers but are less capable. The Klingons did not build light cruisers, but continued construction of the obsolete D6 class for this purpose. The Federation refitted a class of old sublight heavy cruisers with warp engines and used them as CLs. During the General War, cheaper WAR CRUISERS (NCL, D5, SP, HDD, CW, BR, CM, etc.) appeared.

The heavier DREADNOUGHTS are designed as extremely large cruisers with increased weapons and defenses.

The smaller ships include, in decreasing order of size, DESTROYERS, FRIGATES, and ESCORTS. These are used on missions where a cruiser is not required or available and to support cruisers in a combat situation. Because of their cheaper construction, many are built. A squadron of three cruisers facing a squadron of one cruiser, two frigates, and two escorts (which cost almost the same to build) would be outgunned by 10-20%, to say nothing of being outmaneuvered by the more flexible force. The smaller units, however, would be destroyed faster in combat. Also, command limits might make it impossible to use the available BPV with small units.

NOTE: Section (R0.5) Miniatures is in a future product.

**(R0.6) DEFINITIONS**

The term "unit" includes ships, bases, shuttles, fast patrol ships, and seeking weapons.

The term "ship" refers to all ships in the game, including (with certain reservations) bases, pods, and PFs. Freighters and naval auxiliaries are ships, but have some additional limitations.

"Bases" are governed by the same rules as ships and are (technically) considered to be a special sub-classification of ships (those that don't move). The few exceptions, where rules for ships do not apply to bases, are obvious or clearly marked.

"Fast patrol ships," included in Module K and Advanced Missions and variously called fast patrol ships, gunboats, PFs, and pseudo-fighters, are a special sub-classification of ships. Interceptors (K3.0) are treated as PFs except as provided by the rules.

Shuttles are never included in the rules for ships and include both administrative (or utility) shuttles and fighters.

The term "module" is vastly overworked in SFB. It can mean a new product (Module J), a Klingon fire control system (UIM in rule D6.5), a component of a modular ship (e.g., SparrowHawk), a small pod-like item attached to a base to provide extra systems (properly a base augmentation module such as R1.4, R1.16, R1.17, R1.32), and the large "bubbles" on starbases which can dock ships internally and which have a portion of the base's weapons and systems (more properly starbase docking modules). The use should be clear from the context in each case.

All ships are assigned a "size class" to reflect their relative size. There are eight assigned size classes, which are (in general):

- Size class 0 = some very large monsters
- Size class 1 = starbases
- Size class 2 = dreadnoughts and other larger ships
- Size class 3 = cruisers (heavy, light, etc.)
- Size class 4 = destroyers, frigates, escorts, etc.
- Size class 5 = PFs, interceptors, small/medium ground bases
- Size class 6 = shuttlecraft, fighters, heavy fighters
- Size class 7 = drones, plasma torps, DefSats, and mines.

**(R0.7) CARRIER DATA CHART**

All carriers are provided with a Carrier Data Chart, which is generally in this form:

YEAR	ESCORTS	FIGHTERS
Y170-72	CL, EFF	12xAAS
Y173-74	MEC, EFF	12xHAAS
Y173-74	MEC, DWE	12xHAAS

The year column indicates the time when this combination of escorts and fighters was in use. The escort column lists the ships which almost always appear with the carrier. The fighter column defines the fighter group. EW fighters are not noted here; they have their own rules. Generally, one of the 12 fighters is in fact an EW fighter. C-refit fighters (R1.F8) are not listed as their deployment was not universal; see the rule in Module J.

A carrier cannot be purchased without buying its escorts, and the escorts cannot be purchased alone (excepting a very few standard warships, such as the Kzinti CL, which served as carrier escorts during the earliest carrier deployments). A player can always select an earlier type of escorts or fighters and can replace the larger escorts with smaller ones from the same or an earlier period.

**(R0.8) HOW TO READ AN SSD**

Note the SSD below, which is for the Romulan K5R.

**1. CREW UNITS:** One box for each unit (including boarding parties and deck crews). These are checked off for casualties. The Q symbol indicates the minimum crew (G9.4). Just below this is the track for boarding parties, which works in the same manner.

**2. TRANSPORTER BOMBS:** There is one box for each bomb and for each dummy bomb. The number of boxes is the maximum number the ship can carry. See (M3.0).

**3. PROBES:** This track provides one box for each probe in the probe launcher. These are checked off as the probes are used.

**4. SHUTTLECRAFT:** This table is divided into three columns. The first is used to record the counter number. The second is used to record damage. The third column is used to record any special information, such as the loading of a shuttle as a suicide shuttle. Some ships have more than one shuttle bay and have a heavy black line to separate the lines on the chart for the shuttles in each bay.

**5. SHIP DATA TABLE:** This box includes several items.

TYPE: The class type listed on the Master Ship Chart.

POINT VALUE: The BPV; see (S2.1).

BREAKDOWN: The rating for use in (C6.5).

SHIELD COST: The cost of operating the shields; (D3.3).

LIFE SUPPORT: The energy cost. See (B3.3)

SIZE CLASS: The size of the ship; see (R0.6).

CLOAK COST: Only on ships which can have cloaks. This energy cost with (and without) the warp engines; see (G13.2). Those ships with optional cloaks (i.e., Orions) will have the refit cost on their SSD.

REFERENCE: The number that the ship is listed under in the R-section for the owning race.

REFITS: The additional cost of certain improvements.

**6. TURN MODE:** This table shows how many hexes the ship must move forward before it can turn; see (C3.0). The turn mode category is shown by a letter in the upper left. In the mid-left is a box to check off when the ship uses its HET bonus; see (C6.52). If the ship breaks down (C6.51), check off one of the boxes at the lower left. Two boxes are provided. (Few ships could survive a third breakdown, but if yours does, just make an extra mark). Tugs may have more than one chart for different pod configurations.

**7. COUNTER IDENTIFICATION BOX (CNTR):** Record here what counter you are using on the map for this ship.

**8. SHIP TITLE:** The race and type class of the ship.

**9. SHIP SYSTEM DISPLAY:** The actual SSD. Note that shaded boxes indicate a refit.

**10. WEAPON TABLES:** Those needed will be provided.

**11. PSEUDO-PLASMA CHECK-OFF BOXES:** These are marked when each PPT (FP6.0) is used or the launcher is destroyed.

**12. FIRING ARCS:** A standard six-sector firing arc template will be provided. Others may be provided for special cases. Any combined arcs used will be noted. See (D2.0) for more data.

**13. HIT AND RUN BOX:** Those ships with non-SSD items that can be destroyed in a hit and run raid (D7.8) will be noted.

**14. MOVEMENT COST CHART:** This shows the warp energy cost of moving the ship (C2.0) at various speeds. As high energy turns (C6.0) cost the equivalent of five hexes of movement, and the cost of erratic maneuvers (C10.0) is equivalent to six hexes of movement (three hexes for nimble ships), these speeds are marked for quick calculations. Tugs may have more than one chart for different pod configurations.

**15. DRONE RACKS:** The K5R has no drone racks. Each box is used to record the type of drone in that space; the small boxes record the use of reloads. Mark out each box as it is used.

**16. ANTI-DRONES** tracks are simple check-off boxes for the loaded and reload rounds. Types need not be listed as all ADDs are of the same type, but if type-VI drones are used, this can be marked. The KF5R does not have anti-drones.

**17. FIGHTERS:** The K5R has no fighters.

See the diagram below right. As you can see, this is not a formal SSD but is simply a collection of damage point check-off boxes arranged in the shape of a fighter. The various small boxes around it indicate its weapons, chaff, etc.

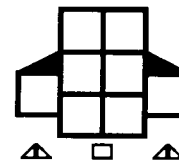

**END OF SECTION (R0.0) BASIC SET**

**1 CREW UNITS**

10	20
----	----

**4 ADMINISTRATIVE SHUTTLES**

IDENT	HIT POINTS	NOTES
THIS SHIP HAS ONE SHUTTLE BAY		

**3 BOARDING PARTIES**

5
---

**2 TRANSPORTER BOMBS**

0	0
---	---

**5 PROBES**

5
---

**13 CLOAK**

<input type="checkbox"/> H&R
------------------------------

**5 SHIP DATA TABLE**

TYPE = K5R  
 POINT VALUE = 78  
 BREAKDOWN = 4-6  
 SHIELD COST = 1/2+1/2  
 LIFE SUPPORT = 1/2  
 SIZE CLASS = 4  
 CLOAK COST = 6/2  
 REFERENCE = R4.5  
 B-REFIT BPV = +6  
 BPV INCLUDES CLOAK

**6 TURN MODE SPEED**

TURN MODE	SPEED
A	1 2-6
HET	2 7-12
	3 13-19
BD	4 20-26
	5 27*

**10 TYPE I OFFENSIVE PHASER TABLE**

DIE RANGE	ROLL 0	1	2	3	4	5	6-9	16	26	51
1	9	8	7	6	5	4	3	2	1	1
2	8	7	6	5	4	3	2	1	1	0
3	7	5	4	4	4	3	1	0	0	0
4	6	4	4	4	4	3	2	0	0	0
5	5	4	4	3	3	1	0	0	0	0
6	4	4	3	3	2	2	0	0	0	0

**11 PSEUDO-PLASMA TORPEDO**

A	F	B
---	---	---

FA = LF + RF  
 RK = L + LR + RR + R

**12 PLASMA TORPEDO WARHEAD STRENGTH TABLE**

RANGE	0-5	6-10	11-12	13-14	15
TYPE F	20	15	10	5	1
BOLT	1-4	1-3	1-2		

**14 WARP ENERGY MOVEMENT COST = 1/2 ENERGY POINT PER HEX**

SPEED	1	2	3	4	5	6	7	8	9	10	11	12	13	14	15	16	17	18	19	20	21	22	23	24	25	26	27	28	29	30
Standard	1	1	2	2	3	3	4	4	5	5	6	6	7	7	8	8	9	9	10	10	11	11	12	12	13	13	14	14	15	15
Fract	1/2	1	1 1/2	2	2 1/2	3	3 1/2	4	4 1/2	5	5 1/2	6	6 1/2	7	7 1/2	8	8 1/2	9	9 1/2	10	10 1/2	11	11 1/2	12	12 1/2	13	13 1/2	14	14 1/2	15

**8 ROMULAN K5R FRIGATE**

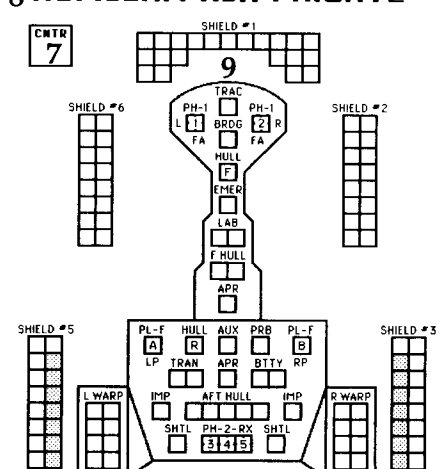

**12 FIGHTING ARCS**

LF RF  
 LR RR

LP RP

SENSOR: 6 5 3 0  
 SCANNER: 0 1 3 9  
 DAMCON: 2 2 2 0  
 EX DAM: [ ] [ ] [ ] [ ]

SSD SHOWS THE REFITTED SHIP WITHOUT THE REFIT, DELETE THE SHADED BOXES AND CHANGE THE PLASMA-Fs TO AN FA FIRING ARC.  
 SPECIAL FIRING ARCS: (D2.33)

**(R1.0) GENERAL UNITS  
USED BY ALL PLAYERS**

**(R1.1) STARBASES (SB)**

The largest type of base, starbases, are normally deployed deep within friendly territory as major bases for fleet operations and training. Major repair and overhaul centers are located at starbases. The destruction of a starbase would normally mean the collapse of an entire sector of the owner's empire. No invading enemy can leave a starbase in its rear because an entire fleet can hide safely under the protection of its weapons.

A counter is provided in Basic Set for a starbase.

**(R1.1A) SSD:** An SSD sheet for a basic starbase is included in Basic Set. SSD sheets for starbases of the various races are not included (they are in Module R1); players must modify the basic SSD sheet accordingly. The last three races are not in Basic Set. See also (R1.R2) in Module R1.

RACE	W1	W2	W3	W4
Federation	Photon	Ph-G†	ADD	Drone
Klingon	Disr	Ph-3	ADD	Drone
Romulan	Plasma-R/F‡	Ph-3	PI-D¥	Void
Kzinti	Drone	Ph-3	ADD	Disr
Gorn	Plasma-R/F‡	Ph-3	PI-D¥	Void
Tholian	Ph-3	Ph-4	Ph-3	Web
Hydran	Hellbore	Ph-G†	Ph-G	Fusion
Lyran	Disr	Ph-3	Ph-3	ESG
ISC	PPD/Plas-F‡	Ph-3	PI-D¥	Void

† Only in starbase docking modules 1, 3, and 5. W2 box in other modules is void. If scenario is before this weapon was invented, use one ph-3 in each of the six W2 boxes.

‡ One weapon of each type in each starbase docking module.

¥ One plasma rack is RF+R+RR, one is RR+LR+L, one is L+LR+RF. Prior to Y165, these were ph-3s-360°.

Starbase docking modules are numbered the same as the sensors in them (also the same as the shield number).

Klingon starbases have one security station in each starbase docking module, and flag bridge boxes count as security. Klingons have one UIM in each starbase docking module; it can control all of the disruptors on the starbase.

Repair boxes are considered cargo in Basic Set.

Void boxes are not present and do not absorb damage.

The shields of starbases were 50 boxes each prior to Y170. These were increased to 70 (each) by Y170 (BPV 650), at which point limited aegis was added. The shields were further increased to 80 each by Y175 (BPV 675), at which point full aegis was added.

Starbase drone racks are type-H (FD3.8). Starbase anti-drones are defined in (FD3.86). Starbases can control a number of seeking weapons equal to double their sensor rating and can use a sensor channel (G24.24) to control more.

After Y181, Federation starbases had a 12-box fighter bay constructed inside the #4 docking module, which increased the BPV by 20, to operate the A-10 or A-20 fighters. This is a single 12-box bay; shuttles launch directly to space, not into the docking module. It is separate from the original 2-box shuttle bay. The docking capacity of this module is reduced from 26 to 20. Other races presumably could have done this instead of basing PFs on their starbases, but none did so. No more than one docking module can have this hangar, and it can only have one 12-fighter bay.

Crew: The SSD provides a large crew unit table. Determine the actual number of crew units for the base and its modules from the Master Ship Chart.

**(R1.1B) AUGMENTATION MODULE MOUNTING:** Starbases have six external mounting positions (one between each secondary module). Ships cannot dock at these positions; they are for base augmentation modules. Each has two positions known as position-A

and position-B. Neither position blocks the use of the other position. These can mount one each of the following.

Position-A: one class-A or class-B augmentation module.

Position-B: one class-B augmentation module or any pod used by the owning race.

**(R1.1B1)** Bases will often have augmentation modules [hangar bay modules (R1.4), PF docking modules (R1.16), power modules (R1.17), or other modules (R1.32)] mounted to position-A. The most common arrangement is four fighter modules and two power modules (later replaced with PF modules). For purposes of Basic Set, ignore all six of the augmentation modules.

**(R1.1B2)** Position-B can dock any type of pod that is used by the owning race's tugs. Pods are docked to bases for storage purposes (so that they do not take up the internal docking space) and (except for pure cargo pods) are not operational. All boxes of all pods docked to a base mounting position-B position (they cannot be mounted to position-A) are treated as cargo. Pods docked to a base mounting position cannot undock (except as specified in a published scenario), produce power, operate systems, fire weapons, launch or recover shuttles or PFs, or perform any other function. Class-B augmentation modules mounted to position-B (or A) are fully functional. [This rule effectively prohibits the use of troop or starliner pods docked externally to a base's augmentation module positions. Such pods could be docked operationally only to the base's normal ship docking stations.]

**(R1.1B3)** The class of each augmentation module (A or B) is shown in its description. Generally, class-A modules provide a significant increase in the base's combat power. There is an additional restriction in that no more than two power augmentation modules can be used on any starbase; no more than one on each BATS or BS.

See (G14.13) for transportation of augmentation modules.

**(R1.1C) NOTES:** Normally, 4-6 police ships, 1-2 frigates or destroyers, and 1 light cruiser were permanently assigned to the starbase under control of the base commander. These are not included in the base's BPV. Major fleet elements, under control of the fleet commander, would normally be found at or near the starbase during peacetime.

The BPV of a starbase does not include the fighters, PFs, or ships assigned to it, nor does it include the augmentation modules attached to it or any pods docked at it.

The Orions, LDR, and WYN do not have starbases. If other races are added in the future, the data published with them will indicate if they do or do not have starbases. Do not assume the presence of starbases unless specifically provided.

AWR on starbases are hit on APR.

All starbases have positional stabilizers (G29.0).

**(R1.1D) DAMAGE PROCEDURE FOR STARBASES:** When a volley of hits penetrates one of the shields of a starbase, use the following procedure for each damage point in turn.

- Determine what system was hit by the DAC.
- Apply the hit (if possible) to a system of the starbase docking module facing that shield.
- Cargo hits on a starbase docking module (which are scored on Repair) can be applied to the ships inside that module. (Freighters, auxiliaries, PFs, shuttles, pods, and modules docked inside a starbase cannot be damaged; only warships can.) These hits are resolved separately as a hit on the #1 shield of the ship. If they penetrate, roll to allocate them. These all count as a single volley (if that ship is destroyed, transfer the remainder of the volley to the next ship). [Cargo/Repair damage may, at the owner's option, be scored on the ships inside that specific docking module before all of the cargo boxes are destroyed. After all cargo boxes in the docking module are destroyed, cargo damage must be scored on the warships. See (C13.62).]
- "Excess Damage" hits on the starbase docking module are not scored as such. The hit penetrates into the main body of the starbase where it is scored on the system called for by that die roll (starting with column A as before, ignoring previously scored **bold** results). Note, however, that hits reaching the main body first strike armor. The upper row of armor boxes is struck by damage penetrating shields 6-1-2, the lower armor by damage penetrating shields 3-4-5. If the appropriate section of armor has been completely destroyed, the hit is scored on the system (in the starbase core) originally called for. Base augmentation

modules cannot be hit unless the armor behind them is penetrated. The special function tracks (sensor, scanner, damage control, excess damage) are part of the core, not of any module. This creates an exception to the phaser directional damage rule.

4. If there is no system of that type remaining in the main body of the starbase, apply that point of damage to any other docking module (but only if the armor behind that module has been destroyed) OR to any of the augmentation modules or docked pods (R1.1B). (Damage to the starbase can never be scored on a ship docked externally to one of the tractors.)
5. If there is no system of that type in the main body or the modules eligible for damage under paragraph #4, move to the next column on the DAMAGE ALLOCATION CHART and repeat steps 3 and 4 above. Excess Damage is scored on the armor on the other side of the core; once this is gone, damage is resolved normally. See also (D4.36).

NOTE: In the case of enveloping weapons, or multiple fire through more than one down shield, the penetrating damage through each shield arc would be resolved versus the facing docking module as a separate volley.



**(R1.1E) INFORMATION REGARDING SYSTEMS IN OTHER PRODUCTS:** This information refers to rules and systems found in other products.

All starbases have scout functions and (as provided in R1.1A) limited or full aegis.

Starbases will have 24 fighters, usually of the most modern/powerful type available.

Federation starbases had 12 F-14 and 12 F-18 (4 hangar bay augmentation modules) until PFs appeared, at which point they had 12 F-14, 24 F-18, and 12 A-10 (or 6 A-20) based in 6 hangar bay augmentation modules and the 12-fighter internal hangar in starbase docking module #4 (for the A-10/20s). Two SWACS were usually available, based in the secondary module that has the fighter bay (replacing the admin shuttles in that bay).

**(R1.1F) DOCKING:** Docking to starbases can be accomplished in one of three ways:

Internal docking in the starbase docking modules; see (C13.6). See also (C13.8) for arming restrictions.

External docking to one of the tractor beams; see (C13.7).

Inactive pods can be docked to the augmentation module mounting points; see (R1.1B).

**EXAMPLE OF STARBASE DAMAGE:** A massive volley by a Federation fleet penetrates the #1 shield of a Klingon starbase (which had no previous internal damage). There is a D5 war cruiser inside docking module #1 (for purposes of this example, the Klingon player does not want to take any damage on this ship; any of the cargo hits could have been scored on it). The 72 points of internal damage are resolved as follows:

**HIT#DIERESULT**

1	2	Bridge (only box, destroyed).
2	3	Drone (only box, destroyed).
3	4	Phaser (scored on the ph-3).
4	5	Right warp†, A Hull (first of six).
5	6	F Hull (second of six hull boxes).
6	7	Cargo (one repair box).
7	8	A Hull (third of six).
8	9	Left warp†, F Hull (fourth of six).
9	10	Phaser (one ph-4).
10	11	Torpedo (one disruptor).
11	12	Aux (only box of type).
12	3	Phaser (destroys special sensor).
13	4	Transporter (first of two destroyed).
14	5	A Hull (fifth of six).
15	6	F Hull (last of six).
16	7	Cargo (second repair).
17	8	A Hull (third repair).

18	9	F Hull (fourth repair).
19	10	Tractor (first of two).
20	11	Phaser (second ph-4).
21	4	R Warp†, Impulse†, F Hull (fifth repair).
22	5	A Hull (six repair box).
23	6	F Hull (seventh repair box).
24	7	Cargo (eighth repair box).
25	8	A Hull (ninth repair box).
26	9	F Hull (tenth repair box).
27	10	L Warp†, Impulse†, A Hull (11th repair).
28	5	A Hull (12th repair).
29	6	F Hull (13th repair).
30	7	Cargo (14th repair).
31	8	A Hull (15th repair).
32	9	F Hull (16th repair).
33	6	F Hull (17th repair).
34	7	Cargo (18th repair).
35	8	A Hull (19th repair).
36	7	Cargo (20th repair).
37	2	F Bridge (Security).
38	3	Impulse†, L Warp†, R Warp†, A Hull (21st repair).
39	4	R Warp†, Impulse†, F Hull (22nd repair).
40	5	A Hull (23rd repair box).
41	6	F Hull (24th repair box).
42	7	Cargo (25th repair box).
43	8	A Hull (26th repair box).
44	9	F Hull (27th repair box).
45	10	L Warp†, Impulse†, A Hull (28th repair).
46	11	Impulse†, R Warp†, L Warp†, F Hull (29th repair).
47	12	Emer†, Scanner†, prob†, F Hull (30th and last repair).
48	3	Impulse†, L Warp†, R Warp†, A Hull†, shuttle (first of two).
49	4	R Warp†, Impulse†, F Hull†, A Hull†, L Warp†, APR (first AWR).
50	5	A Hull†, Cargo (first hit on D5).
51	6	F Hull†, Impulse†, Lab†, L Warp†, Sensor†, tractor (2nd and last).
52	7	Cargo (second hit on D5).
53	8	A Hull†, APR (second AWR).
54	9	F Hull†, Cargo (3rd hit on D5).
55	10	L Warp†, Impulse†, A Hull†, F Hull†, R Warp†, APR (third AWR).
56	11	Impulse†, R Warp†, L Warp†, F Hull†, Tractor†, DamCont†, C Warp†, Lab†, Battery (first of four).
57	4	R Warp†, Impulse†, F Hull†, A Hull†, L Warp†, APR (fourth AWR).
58	5	A Hull†, Cargo (4th hit on D5).
59	6	F Hull†, Impulse†, Lab†, L Warp†, Sensor†, tractor†, shuttle (2nd and last).
60	7	Cargo (5th hit on D5).
61	8	A Hull†, APR (fifth AWR).
62	9	F Hull†, Cargo (6th hit on D5).
63	10	L Warp†, Impulse†, A Hull†, F Hull†, R Warp†, APR (sixth and last AWR).
64	5	A Hull†, Cargo (7th hit on D5).
65	6	F Hull†, Impulse†, Lab†, L Warp†, Sensor†, tractor†, shuttle†, R Warp†, phaser†, transporter (2nd and last).
66	7	Cargo (8th hit on D5).
67	8	A Hull†, APR†, shuttle†, R Warp†, Scanner†, Tractor†, Lab†, L Warp†, phaser†, Trant†, Battery (2nd of four).
68	9	F Hull†, Cargo (9th hit on D5).
69	6	F Hull†, Impulse†, Lab†, L Warp†, Sensor†, tractor†, shuttle†, R Warp†, phaser†, transporter†, battery (3rd of four).
70	7	Cargo (10th hit on D5).
71	8	A Hull†, APR†, shuttle†, R Warp†, Scanner†, Tractor†, Lab†, L Warp†, phaser†, Trant†, Battery (last of four).
72	7	Cargo (11th hit on D5).

† None of this type, go to next column.

**(R1.2) BATTLE STATIONS (BATS)**

By Y160, all base stations on national borders had been replaced with the more powerful battle stations. BATS had been in operation much earlier; the first "starbases" were in fact battle stations. Virtually all borders are guarded by a network of battle stations.

**(R1.2A) SSD:** An SSD is provided for a generic battle station; use the following data to produce the SSD for a BATS of any race.

RACE	W1	W2	W3
Federation	Photon	ADD/Drone‡	Void
Klingon	Disr	ADD/Drone‡	Scty
Romulan	Plasma-R/F‡	PI-D¥	Void
Kzinti	Disr/ADD‡	Drone	Void
Gorn	Plasma-R/F‡	PI-D¥	Void
Tholian	Ph-4	Ph-3	Web
Orion	Option	See below	Void
Hydran	Hellbore	Fusion	Void
Lyrans	Disr	Ph-3/ESG‡	ESG
ISC	PPD/Plas-F‡	PI-D¥	Ph-3
WYN	Option	Drone	Void
LDR	Disr	ESG†	ESG

- ‡ One weapon of each type.
- † One weapon, second box is void.
- ¥ One plasma rack is LS, the other is RS. Prior to Y165, these were ph-3s-360°.
- Hydran and LDR BATS have one ph-G replacing each pair of ph-3s after ph-G introduction.
- Void boxes are not present; they do not absorb damage.
- Orion BATS have one ph-1 replacing each ph-4. Orion BATS have either drones or plasma-D¥ in Weapon-2, depending on the sector. Orion BATS have smaller crews; see Master Ship Chart.
- Klingons and Lyrans have one UIM total (D6.56); it can control all of the disruptors on the station.
- Drone racks are type-D; see (FD3.8). Anti-drones are ADD-30s (FD3.86).
- Original shields were 30 boxes each. In Y170, limited aegis was added and the shields were increased to 35 boxes, the BPV to 215. In Y175, the shields were increased to 40 boxes and full aegis was installed; BPV = 230.
- The hangar bay modules can be used if you have Module J or Advanced Missions, or you can approximate the effect by allowing other races to use the Kzinti fighters.
- Crew: The SSD provides a large crew unit table. Determine the actual number of crew units for the base and its modules from the Master Ship Chart.

**(R1.2B) NOTES:** Repair is considered cargo in Basic Set. Use the base station counter for the BATS. All races have a BATS counter in their appropriate colors in Module R1. Damage to BATS is resolved as if they were ships with the exception of AWRs; see (H4.32). Damage that penetrates the shields is scored on armor (D4.12) until that is all destroyed, then distributed by DAC. BATS have no internal docking capability. See (R1.2) in Module R1 for early weapons.

**(R1.2C) AUGMENTATION MODULES:** Battle stations have three external docking positions (one between each secondary module). Each of these have a position-A and position-B docking point and operate as those on a starbase do; see (R1.1B). Prior to Y160 these were usually one power and two cargo modules. By Y170 two had been replaced with hangar bays, and by Y180 the third had been replaced with a PF dock (R1.2E).

**(R1.2D) ADDITIONAL DATA:** The sensor, scanner, damage control, and excess damage ratings of all battle stations are as shown on the SSD. BATS can control a number of seeking weapons equal to their sensor rating.

The BPV of a battle station does not include the fighters, PFs, or ships assigned to it, nor does it include any pods or augmentation modules docked at or to it. All BATS have positional stabilizers (G29.0).

**(R1.2E) INFORMATION ON SYSTEMS IN OTHER PRODUCTS** All battle stations have scout functions and (R1.2A) aegis. Most races based 6 PFs (in a PF module) at each battle station after PFs were deployed. The Federation, which had no PFs, responded with an additional HBM with heavy fighters. Repair is considered cargo and center hull in Basic Set.

**(R1.3) BASE STATIONS (BS)**

Base stations were originally deployed along most national boundaries, but by the time of the General War, they were outclassed. During the General War, base stations would only be found in the interior, operating as regional headquarters and supply bases. As the war ebbed and flowed across the borders, many a base station commander suddenly found himself on the front line. A counter for a base station is in Basic Set.

**(R1.3A) SSD:** An SSD for a generic basic base station is included. Players must make the following modifications to create the specific base station for each race.

RACE	W1	W2	W3	W4
Federation	Photon	Void	Drone	ADD
Klingon	Disruptor	Security	Drone	ADD
Romulan	Plas-S	PI-D¥	Void	Void
Kzinti	Disruptor	Drone	ADD	Void
Gorn	Plas-S	PI-D¥	Void	Void
Tholian	Ph-4	Ph-3-360°	Web	Void
Orion	Option	See Below	Void	Void
Hydran	Hellbore	Fusion-360°‡	Void	Void
Lyrans	Disruptor	ESG	Void	Void
ISC	PPD	PI-D¥	Void	Void
WYN	Option	Drone	ADD	Void
LDR	Disruptor	ESG	Void	Void

- ¥ One plasma rack is LS, the other is RS. Prior to Y165, these were ph-3s-360°.
- ‡ Only one fusion beam on Hydran BS. Hydrans and LDR replace each ph-3 with one ph-G. Orions have 1 phaser-1 in place of each pair of phaser-4s. The Orions do not have phaser-4s. Orion BS have either drones or plasma-D¥ in Weapon-2, depending on the sector. Orion BS have smaller crews; see Master Ship Chart. Original shields were 21 boxes each. This was increased to 30 boxes (and limited aegis) in Y170; BPV = 138. This was increased to 35 boxes (and full aegis) in Y175; BPV = 148. Crew: The SSD provides a large crew unit table. Determine the actual number of crew units for the base and its modules from the Master Ship Chart. BS has type-D drone racks and ADD-12s. BS controls seeking weapons equal to sensor rating.

**(R1.3B) NOTES:** Repair is considered Cargo and Center Hull in Basic Set. Damage to BSs is resolved as if they were ships with the exception of AWRs; see (H4.32). There is no internal docking.

**(R1.3C) AUGMENTATION MODULES:** Base stations have three external docking positions (one between each secondary module). Each of these have a position-A and position-B and operate as those on a starbase do; see (R1.1B).

**(R1.3D) ADDITIONAL DATA:** The sensor, scanner, damage control, and excess damage ratings of all base stations are as shown on the SSD.

Normally 1-2 small ships (frigate, police) were assigned directly to the station (not under fleet control but included in fleet OB).

The BPV of a base station does not include the fighters, PFs, or ships assigned to it, nor does it include the augmentation modules or pods docked at it.

All BSs have positional stabilizers (G29.0).

**(R1.3E) INFORMATION REGARDING SYSTEMS IN OTHER PRODUCTS:**

All base stations have scout functions.

Generally, most base stations had one hangar module and two cargo pods. After PFs were invented, most races based six PFs (in a PF module) at many of their base stations; many had only fighters for local defense. Some Federation base stations had as many as three hangar bay modules.

See (R1.R2) for base weapons during earlier time periods.

**OTHER UNITS USED BY ALL RACES**

**(R1.4) HANGAR BAY AUGMENTATION MODULES (HBM):** By the time of the General War, the need for additional protection and firepower had forced most bases to be equipped with fighters. To simplify construction, all races built hangar bay modules and attached them to their bases. Each type of base has its own rules for mounting these. These do not come automatically with a base; their presence will be listed in a scenario if applicable.

These modules can be seen on the three base SSDs in Basic Set; each has six fighter boxes, two cargo boxes, a tractor beam, and a hull box. Each module counts as a separate hangar bay for purposes of operating fighters.

Class-A Augmentation Module.

HYDRAN and Tholian HBMs (only) have APR in place of cargo.

PLASMA (Gorn, Romulan, ISC) HBMs store type-D torpedoes in the cargo boxes.

All modules have storage space for 2 sets of warp packs (when available), 2 EW pods, and 10 chaff packs per fighter (including the original loading). In addition, the 2 cargo boxes hold a total of 100 spaces of drones (or type-D plasma torpedoes), including the first loading of each fighter. (Pay the upgrade costs for one loading of each fighter; the proportional reloads are then free.)

**(R1.5) SMALL FREIGHTERS (F-S):** This design is typical of the many small freighters operated by all races. It is, basically, a cargo pod with small engines and a small crew cabin added. Freighters (except auxiliaries) cannot have cloaking devices. See (G14.71) and (G14.73).

Maneuver limit: The small freighter (and its variants, except as noted) cannot disengage by acceleration (C7.1) and cannot accelerate by more than three movement points per turn (warp and impulse combined).

SSD and counters are in Basic Set and Module R1.

Variants: Troop Transport (R1.18), Armed Freighter (R1.20), Repair Ship (R1.25), Exploration Freighter (R1.26), Minelayer (R1.12), Suicide Freighter (R1.33), Auxiliary Carrier (R1.13), Auxiliary PFT (R1.27), WYN Auxiliary Cruiser (R12.6), WYN Auxiliary Carrier (R12.7), WYN Auxiliary PFT (R12.8), WYN Auxiliary Minesweeper (R12.11), Q-Ship (R1.7), Tholian Web Tender (R7.10).

**(R1.6) LARGE FREIGHTERS (F-L):** Similar to the small freighter, the large freighter is two cargo pods with larger engines and facilities. Within its limits, it approaches the full range of starship capabilities. Freighters (except auxiliaries) cannot have cloaking devices.

Maneuver limit: The large freighter (and its variants, except as noted) cannot disengage by acceleration and cannot accelerate by more than four movement points per turn (warp and impulse combined).

SSD and counters are in Basic Set and Module R1.

Variants: Troop Transport (R1.19), Armed Freighter (R1.21), Repair Ship (R1.25), Exploration Freighter (R1.26), Minelayer (R1.12), Suicide Freighter (R1.33), Auxiliary Carrier (R1.13), Auxiliary PFT (R1.27), Auxiliary SCS (R1.31), WYN Auxiliary Battlecruiser (R12.9), WYN Auxiliary Heavy Carrier (R12.10), Q-ship (R1.7).

**(R1.7) Q-SHIPS**

All fleets, having had trouble with pirates (not to mention conventional warships on commerce raiding missions during wartime), have constructed and operated Q-ships. These are specially modified freighters equipped with heavy weapons but designed to appear as normal freighters. Q-ships are considered Naval Auxiliaries.

No inter-bay transfers (J1.59) are possible on any Q-ship.

**(R1.7A) BASIC SET** includes Q-ships for the Federation, Klingons, and Gorns (SSDs for each). For purposes of Basic Set, the Tholians can use the Federation Q-ships, the Romulans can use the Gorn Q-ship, and the Kzintis can use the Klingon Q-ship. Q-ship counters are found in Module R1; regular freighter counters can be used. Romulan, Kzinti, and Tholian Q-ships are in Advanced Missions.

Hydran and Lyran Q-ships are in Module C1.

ISC Q-ships are in Module C2.

LDR Q-ships are in Module C3.

**(R1.7B) SPECIAL Q-SHIP RULES:** Q-ships appear as normal freighters; they operate their shields at freighter strength (no energy difference) until detected. They cannot be detected as Q-ships until one of the following events:

They erect their shields at full (Q-ship) strength.

They fire any of their non-standard weapons or otherwise do something a standard freighter cannot do.

They are boarded or subjected to a successful hit and run raid.

Whenever a Q-ship is hit by weapons of any type, the owning player has the option of revealing his status as a Q-ship at that point. If this is done, the Q-ship can immediately raise its shields to full strength and fire some or all of its weapons, BEFORE the effects of incoming fire are resolved but AFTER the number of damage points scored is known. (This violates the normal Sequence of Play.)

The discharge of weapons by a Q-ship (not firing them, but draining the energy because the weapon was not needed and it could not be held) cannot be detected. The weapons are drained into a large expansion chamber in the hollow hull and then drained through the warp engines (no gain in power or speed), a convenience not available to standard warships.

**(R1.7C) MOVEMENT:** Q-ships can accelerate by five movement points per turn (combined warp and impulse) or to double their current speed (whichever is greater) and can disengage by acceleration.

**NOTE:** The following unit is presented out of the normal numerical sequence. It is used in one of the Basic Set scenarios. The scenario turned out so well that, years later, we added the ship as a formal class instead of a temporarily converted freighter.

**(R1.13A) SMALL AUXILIARY CARRIER (AxCVL):** Most races produced and operated so-called auxiliary carriers built on modified freighter hulls. These were intended originally to transport fighters between bases and carrier groups; some later served as convoy escorts. No AxCV and cloak.

Auxiliary carriers do not have formal escort groups. Those supporting fleet carriers will have the same fighters as those carriers. Those used for convoy escorts will tend to have older or second-best fighters.

Maneuver: Auxiliary carriers are naval auxiliaries. They can accelerate by up to five movement points (or double the current speed) per turn and can disengage by acceleration.

Weapons (for the Kzinti AxCVL) are as follows:

RACE	A	B	Drone Storage
Kzinti	Ph-1	ADD	100 Spaces

The small auxiliary carrier carries 12 fighters and 3 admin shuttles in one bay. The SSD for the small auxiliary carrier is in Basic Set. The counter for the small auxiliary carrier is in Module J. In Basic Set (SH5.0), use a small freighter counter.

**END OF SECTION (R1.0) BASIC SET**

**(R2.0) THE UNITED  
FEDERATION OF PLANETS****(R2.1) FEDERATION BACKGROUND**

The United Federation of Planets is the only major political unit in Basic Set that is not dominated by a single race of beings. (The WYN in Module C1 and the ISC in Module C2 also fit this description.) Several races (Human, Vulcan, Andorian, Rigelian, Alpha-Centauran, Cygnan, etc.) hold seats on the ruling council; two dozen other races are affiliate members; and colonies or stations have been established on a thousand other planets. Most ships are manned 90% by one race, with the other 10% being a mixture of all others.

The Federation is dominated by the Humans, including those of Earth parentage who were born on other planets. Humans provide more than 70% of Star Fleet personnel and dominate every phase of its operations. Humans are regarded as the most militaristic, but not the most warlike, of the member races of the Federation.

The Federation is probably the most idealistic of all the empires. Federation ships never attack without warning, and while the Federation has fought wars with all of its neighbors, it has never started one. The Federation has negotiated boundaries with all of its neighbors and has never sought to expand them militarily.

Economically, however, the Federation is the most aggressive race in the known area of the galaxy. Federation merchant ships are found almost everywhere during peacetime, and the "Neutral Zones" between the Federation and its neighbors abound with Federation colonies set up within the strict letter of the relevant treaties. The Federation considers "peace" to include free access to the markets and ports of all other races. Since the Federation has the strongest economy, it has the most money to buy things with and the most production capacity to build things with and tends to dominate the galactic economy.

The Federation has treaties of alliance and friendship with the Kzintis and Gorns although ties with the Gorns appear stronger. The Federation had (at one point) mutual non-aggression pacts with the Klingons and Romulans. The Tholians indicate that they feel the best treaty is to simply never have contact.

**(R2.R0) FEDERATION FLEET REFITS****(R2.R1) FEDERATION "+" FLEET REFITS**

Beginning about Y165, the Federation began updating its ships in order to maintain its military forces at a level sufficient to deter attack. Due to budget restrictions and a short-sighted attitude by the civilian administrators (who failed to foresee the coming General War), only about 20% of the fleet had been updated by the time the war began. The update program was accelerated after Y171.

These "plus" refits included various combinations of extra shielding, power, drone racks, and (almost always) a pair of ph-3s for close-in defense against drones and fighters.

The cost and extent of these refits is shown on the SSD for each ship that received this refit (or any other for that matter). The dates that the refit was effective (squadron service; there is no prototype date) is shown in the description or on the Master Ship Chart.

Ships with this refit are designated with a "+," such as CA+, DN+, etc. The DN+ refit was so extensive that it is listed as a separate class (R2.17).

The FF+ refit is listed as the FFG; this refit preceded the other classes, starting in Y160. This refit was applied to the FF, FFD, FFM, and FFS; rarely to the FFE, FFR, and FFL; and very rarely to the FFT, FFP, or FFV.

**(R2.R2) REAR PHASER REFIT:** Federation CA and CA+ ships (and only that class) were fitted with rear-firing phasers. Some ships carried these as early as Y160; all had been refitted by Y175. Some received them before their (R2.R1) refit, some afterwards, and others at the same time. This refit includes two phaser-1s in the rear hull with RH firing arcs. CAs with this refit are designated CAR or CAR+ as appropriate.

**(R2.R3) AWR REFIT:** Many Federation ships were modified with warp reactors (AWR) replacing the nuclear reactors (APR), providing more power for the photon torpedoes. This refit began in Y170, and virtually all Federation ships (those armed with photon torpedoes) were refitted by Y174, with new construction from Y170 incorporating the refit. The refit and its cost are shown on the SSDs of ships that received it. It does not apply to the PFs (which are conjectural in any case). Ships with this refit are given the "a" designator, e.g., CCA+.

**(R2.R4) DRONE RACK REFIT:** As the General War went on, the old type-A drone rack was found less and less suitable for the evolving combat situation. The Federation upgraded the drone racks on its ships (including pods and auxiliaries; bases have H-racks and are not included) at about the start of Y175. It is assumed that this refit applies to all Federation ships as of 1 Jan Y175. It does not apply to the PFs (which are conjectural in any case).

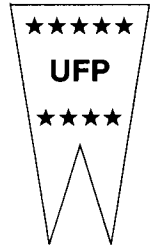

All anti-drones (carried by relatively few Federation ships) were converted to type-G drone racks (cost 2 points each); all type-A drone racks were converted to type-B (cost 1 point each).

Unless otherwise specified in the rules, all ships (including those with no drone rack changes in Y175) have double drone reloads (no cost for the basic drones; speed and module costs are extra) as part of this refit. Type-G racks have three sets of reloads after the refit; the third set of reloads must be ADDs.

**(R2.R5) NOTE ON ESCORTS:** Federation carrier escorts, unique in the galaxy, had cargo boxes to store spare fighters, drones, warp packs, chaff pods, etc., allowing Federation carrier groups to remain on patrol longer than any others (so long as they avoided direct combat) and giving them a significant edge.

The spare fighters on the Master Ship Chart for these escorts are stored in half of the cargo boxes. The other cargo boxes can be loaded by the owning player with drones, warp packs, chaff pods, etc. This is at no cost although the drones must be proportional to the drones stored on the carrier. These ships use this cargo storage instead of, not in addition to, the (J4.621) supplies.

This would only be significant in a campaign game [e.g., (U4.0)] where the carrier group must complete several scenarios with whatever supplies are on board. (The existing supplies on most carriers will be adequate for most scenarios.) If a cargo box is destroyed, the contents are lost (the owner selects which specific contents are lost).

Not all Federation escorts have cargo boxes. Those that do not ignore this note.

**FEDERATION WARSHIPS**

**(R2.2) DREADNOUGHT (DN):** The "space battleship" of Star Fleet, the dreadnought is the largest and most powerful Federation ship in Basic Set, but is slightly inferior to other dreadnoughts. The original design concept of the DN was to include more capabilities but only a minimal increase in firepower over the CC. This was found to be inadequate after other races began fielding DNs that reflected an approximate 50% increase in firepower over their respective CCs. Each fleet is commanded by an admiral in a dreadnought, but during peacetime the dreadnought is usually docked at a starbase because it is too expensive to operate. SSD and counters are in Basic Set.

Variants include DN+ (R2.17) and DNG (R2.61)

**(R2.3) COMMAND CRUISER (CC):** The command cruiser is an improved variant of the standard heavy cruiser, noted for its firepower and versatility. Normally, the admiral commands his fleet from a command cruiser during peacetime. Command cruisers (most fleets have similar ships) are marginally better in firepower and considerably superior in command, control, and communication facilities as compared to CAs. As the General War continued, many surviving CAs were converted into CCs.

SSD and counters are in Basic Set.

**(R2.4) HEAVY CRUISER (CA):** The workhorse of Star Fleet, the Federation heavy cruiser (known as the *Constitution* class) is probably the most balanced all-around starship in the game. In combat, this ship relies on its toughness and on a flexible use of its power. This ship incorporated several incremental improvements (i.e., refits) which kept it competitive throughout the long history of this class.

SSD and counters are in Basic Set.

Variants include the Command Cruiser (R2.3), Strike Carrier (R2.29), and Heavy Command Cruiser (R2.76).

**(R2.5) LIGHT CRUISER (CL):** The CL is a rebuilt hull that is over 100 years old. These ships originally fought in the First Romulan War. When warp power was developed, many of these ships were converted to use it. They formed the backbone of Star Fleet for two decades, before enough heavy cruisers came into service to assume that role. This ship is equipped with armor (D4.12), which was used before the more efficient shields were developed. This ship had a good operating speed and excellent reserve power but, until it was refitted, it was vulnerable to relatively minor damage.

Many of these ships were converted to support missions (escort cruisers, minesweepers, survey ships, hospital ships, etc.) during their service.

SSD and counters are in Basic Set.

Variants include the Minesweeper (R2.21), Escort Cruiser (R2.15), Light Survey Cruiser (R2.39), Hospital Ship (R2.40), and Commando Cruiser (R2.31).

**(R2.6) DESTROYER (DD):** The destroyer was designed as a smaller and less expensive stablemate to the CA, but was less successful. While it carries cruiser armament, it lacks the engine power of a cruiser, making full (i.e., overloaded) use of its photon torpedoes impractical. While lacking maneuverability, its large saucer section makes it capable of taking considerable punishment without losing warp power.

The Federation destroyer was expected, during peacetime, to carry out essentially the same research and exploration missions as the heavy cruiser class. For this reason, it had the same laboratory facilities.

Several experiments were performed in an attempt to solve its chronic power shortage, leading to the DDG and DDL designs. At the outbreak of the General War, an emergency refit program (R2.R1) improved the power output of these ships (at the cost of surplus laboratory facilities), keeping them viable for many years. Production of the DD virtually ceased at the start of the General War in favor of the NCL; a new smaller war destroyer was built several years later.

It remains something of a mystery why the DD did not gain a drone rack (as most other Federation ships did) in its refit.

SSD and counters are in Basic Set.

Variants include the Scout (R2.7), Destroyer Escort (R2.14), DDL Destroyer Leader (R2.27), DDG Guided Weapons Destroyer (R2.28), and Romulan border Escrot (R2.62).

**(R2.7) SCOUT (SC):** Built on a destroyer hull, the scout was designed to be the electronic eyes and ears of the fleet. The name can be confusing. The ship does not actually move ahead of the fleet, but uses its long-range sensors and scanners to search farther than other ships can.

The wartime refit reduced laboratory capabilities in exchange for more power for use in electronic warfare. It appears that one or two scouts retained their original laboratory facilities for several years after the war began for scientific missions of military significance.

The large number of special sensors made this ship particularly effective on scientific missions (at least, before the wartime refit reduced the lab capabilities) and in a hostile drone environment.

Special sensors 1-4 are destroyed by torpedo hits, while special sensors 5-8 are destroyed by phaser hits.

SSD and counters are in Basic Set.

## FEDERATION FLEET TUG AND PODS

**(R2.8) FLEET TUG (Tug):** Used by Star Fleet to transport priority military and government cargoes (civilian freighters being adequate for other loads), the tug is a full-fledged starship with limited armament suitable to its mission.

The 12 hull boxes can be hit on forward or aft hull hits unless the tug is towing a pod, in which case these are hit on forward hull hits and the hull or cargo boxes in the pod are destroyed by "aft hull" hits. Cargo boxes would still be destroyed by cargo hits.

The Federation tug can carry one or two pods; one but not both can be a "double weight" pod. If there is a double-weight pod, it must be in front. The movement cost chart lists "with 3 pod weights" to indicate the movement cost when carrying one single and one double-weight pod; this does not indicate that it can carry three pods.

The pods are in-line, one attached to the tug and the other to the first pod. The FA firing arcs (including the FA portion of FX, LS, RS, or 360° arcs) on the rear pod are blocked by the forward pod. The RA firing arcs (including the RA portion of RX, LS, RS, or 360° arcs) on the front pod are blocked by the rear pod.

If a battle pod (or light battle pod) is in the rear position, all systems on the pod are treated as cargo.

No interbay shuttle transfers (J1.59) are possible between pods.

The SSD and counters are in Basic Set. There are no variants.

**(R2.9) STARLINER POD (P-SL):** The starliner is designed for the transportation of 300 personnel. Too expensive to use for colonization, it usually carries relief crews to isolated stations. The starliner pod is capable of independent operations at sublight speed. If detached, the 22 hull boxes can be hit on either forward or aft hull hits. If attached to a tug, these 22 boxes are hit on aft hull hits; those on the tug are considered forward hull in this case.

When used to carry troops, the starliner pod has 62 boarding parties, of which 2 are commando and 6 are heavy weapons. The BPV is increased by 37. (There are no GCVs or GASs as the SL pod was not designed for use as a troop transport.)

The SSD for this pod is on the Federation Pods sheet in Basic Set. Counters for separate pods are in Basic Set.

**(R2.10) BATTLE POD (P-BP):** As tugs cost as much as cruisers to build, competition between the fighting and logistical elements of the fleet for construction funds is fierce. To partially offset this, battle pods were constructed and held in storage at starbases. A tug carrying a battle pod (the combination being called a "battle tug" and listed separately on the Master Ship Chart) is operationally similar to a DN or CA. Thus, an expensive peacetime transport can be converted in hours to a serviceable warship. The battle pod weighs twice as much as other pods and counts as "two pods" for purposes of movement cost and turn mode.

The 10 hull boxes can be hit on either forward or aft hull hits. If attached to a tug, these 10 boxes are hit on aft hull hits; those on the tug are considered forward hull in this case.

Some battle pods were improved to the BP+ configuration by converting their APR to warp reactors (as well as adding a drone rack and two ph-3s), which allowed them to fire their photon torpedoes while separated from the tug and allowed the battle tug a higher speed in combat. Without the refit, the battle pod was effective only against non-moving targets. The designations for combinations are as follows:

BT.....Neither has refit.  
BT+.....Battle pod has refit, tug does not  
BT++.....Both have refit.  
BT(+)...Tug has refit, battle pod does not.

The entire concept of "battle pods" was created by *Barry Jacobs*.

The SSD for this pod is on the Federation Pods sheet in Basic Set. Counters for separate pods are in Basic Set.

**(R2.11) CARGO POD (P-CP):** There are actually several types of cargo pod (liquid, break-bulk, container, pallet, dry bulk, etc.), but all are functionally identical. Cargo pods are simply cargo boxes; there is no crew or other function. When detached, any hits on the pod are considered to be cargo hits.

See (R2.8) when attached to a tug.

The SSD for this pod is on the Federation Pods sheet in Basic Set. Counters for separate pods are in Basic Set.

**NOTE:** Additional pods will be found at (R2.52) and (R2.57).

**END OF SECTION (R2.0) BASIC SET**



**(R3.0) THE KLINGON EMPIRE****(R3.1) KLINGON BACKGROUND**

The Klingon Empire arose on the ruins of a previous one (known only as "The Old Kings") of which the Klingons had been a subject race. The Old Kings had used Klingons primarily in their starship crews, and when the Kings disappeared (legend has it they left to avoid the death of the Galaxy, since stars in the core are already falling into a gigantic black hole), the Klingons quickly picked up the pieces.

The Klingon Empire is a poor one, and it can only match the Federation in military power at the cost of a lower standard of living for its people. Any attempt to match the Federation standard of living would require disbanding the military forces, leaving the Empire vulnerable to a host of enemies.

The Klingons have three major enemies (the Kzintis and Hydrans, with whom many wars have been fought, and the Federation, which has not been an active military enemy but which threatens the Empire with economic domination). Three minor powers (the Tholians, who occupy stolen Klingon territory, the LDR, and the WYNs) are on the Klingon borders. The Klingons have alliances with the Lyrans and Romulans, races they have fought in the past.

Klingons are generally regarded as a brutal warrior race, but this characterization is not entirely fair or accurate. Klingons are humanoids very similar to terrestrial humans, but only a tiny portion of their planetary populations are selected as warriors, so those Klingons typically encountered tend to be physically large and well-muscled. The reputed military mindset of Klingons is due more to the fact that the only Klingons most humans have met are soldiers than to any cultural or racial trait.

Klingons are not brutal. They do not hesitate to use force if it is the most appropriate course of action, but do not necessarily think of force as the first or only alternative. Klingons will not attack civilian targets simply for the thrill of killing defenseless people, but neither will they hesitate to attack a military target just because it is surrounded by civilians. The Klingons will also tend to see nominally civilian targets as military targets if they are involved in military-oriented production or support activities (e.g., workers at a weapons factory). The Klingons have also been known to destroy civilian colonies in the Neutral Zone (when they can get away with it) to prevent them from claiming possession of entire planets for the Federation.

The Klingon Empire includes at least 12 planets with native sentient races, all of them subservient to the Klingons themselves. Almost 60% of all Klingon Empire starship crewmen are non-Klingon. These are known as "subject races" and are considered less politically reliable than ethnic Klingons. They are almost never allowed to navigate starships or fire their weapons. It is something of a mystery why Klingon warriors would rather fill out their crews with politically unreliable non-Klingons than simply draft ethnic Klingon civilians for that role. This does not appear to be a secret; the Klingons simply cannot understand why the reason is not obvious to the Federation.

The subject races include the Dunkars (orange-skinned humanoids who hold many technical positions), Slidarians (which appear to be something of a cross between an ape and a bear with a decidedly cranky disposition; they form the bulk of ground combat troops), Hilladarians (reptile-humanoids who also serve in ground combat units), Zoolies (humanoids with two pairs of eyes used as scouts in Klingon ground units), and Cromargs (dwarfs from a radioactive planet, the genetically-deformed descendants of a race that destroyed itself in a nuclear war; they hold many technical positions).

The Klingon forces include the Deep Space Fleet (DSF), which is the regular military Navy, and the Internal Security Force (ISF). All ship names (ISF and DSF) are preceded with IKV (Imperial Klingon Vessel).

The ISF, which operates mostly small ships, is a combined police, customs, tariff regulation, border patrol, safety & rescue, and anti-piracy force, which is also assigned the duty of watching the various subject planets for signs of rebellion. The ISF is inferior (in military, political, and social standing) to the DSF.

The Empire Security Service includes internal security and counter-espionage branches, but is best known for the security forces which are on all ships to make certain that the subject races do not take control (and to make certain that the officers do their duties to the Empire). External intelligence is a function of the Klingon General

Bureau. The DSF and ISF also maintain their own external intelligence agencies (DSF external intelligence is the Galactic Research Unit; ISF external intelligence is the Maximum Veracity Directorate), leading to the usual duplication of effort and political infighting.

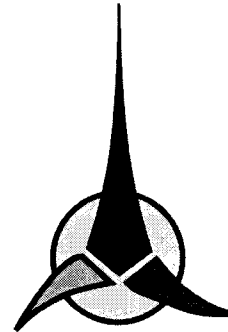
**(R3.R0) KLINGON FLEET REFITS****(R3.R1) FLEET "B" REFITS**

Most Klingon ships built before the war received the B-refit to correct various design deficiencies. These refits began to appear in Y165; most ships had received the refits before the Klingons entered the General War in Y168, and virtually all of them by the time they were committed to action in the various theaters. Generally, this refit included the following features:

DERFACS fire control was added to those ships with sufficient disruptor range (23+) to make use of it.

The #3, #4, and #5 shields were strengthened.

An anti-drone (ADD) system was added.

The drone racks, previously limited to firing one drone from each pair of racks each turn (FD4.3), were improved to allow each rack to fire on each turn. The vulnerability to chain reactions (D12.0) was eliminated.

Some ships received other improvements; for example, the disruptors on the D6 were given longer range.

Those Klingon ships which received this refit have the appropriate information included on their SSDs. Ships with the B-refit are designated with a B, as in D6B, F5B, etc. Some ships, such as the C7, D5, F6, and E5, did not receive the B-refit because it was, effectively, designed into these ships from the start.

**(R3.R2) "K" REFITS:** Most Klingon ships were originally built with phaser-2s. As the technology for phaser-1s became more affordable, many ships were given a K-refit which improved some of their phaser-2s to phaser-1s. Those ships which received this refit are noted on their individual SSDs.

Ships with the K-refit have a K appended to their designation, for example the D7K or the D7VK. (Command ships without the K-refit have the subscript C, those with the K-refit have the subscript L. Thus, an F5C does not have the K-refit while an F5L does.)

Ships which have a B-refit never received the K-refit without first receiving the B-refit. Thus, a D7K is a D7B with the K-refit; the designation D7BK would be redundant. The cost of the B-refit is not included in the K-refit.

Some ships received their K-refits as early as Y169 (prior to the dates on the Master Ship Chart), and by Y175 all command ships (C9, C8, D7C, D5C, F5C) had received it, as had perhaps half of the "direct combat" ships (standard warships, carriers, etc.). Virtually all direct combat ships had it by Y180. Some variants (minesweepers, scouts, drone ships, exploration ships, cargo transports, commando ships, PF tenders, PFs, and penal ships) never did receive it.

**(R3.R3) UIM REFIT:** Available (not always standard) to ships with range-22/30/40 disruptors in Y165 and later, costs 5 points per module. (A maximum of two modules can be purchased as Commander's Options in addition to those specified as Standard Equipment, if any.) Also available to Lyrans.

**(R3.R4) DRONE RACK REFIT:** As the General War went on, the old type-A drone rack was found less and less suitable for the evolving combat situation. The Klingons upgraded the drone racks on their ships (including pods and auxiliaries; bases have H-racks and are not

included) at about the start of Y175. All anti-drones were increased to 12 rounds (cost 1.5 points each rack); all type-A drone racks were converted to type-B (cost 1 point each rack). Unless otherwise specified, all ships (including those with no actual changes to their racks) have double drone reloads (no cost for the extra basic drones, speed and module costs are extra) as part of this refit. It is assumed that this refit applies to all Klingon ships as of 1 Jan Y175. This does not apply to PFs. D-racks on bases are also not covered by this refit.

**(R3.R5) PENAL REFIT:** This rule is in Module R3.

### KLINGON WARSHIPS

**(R3.2) C9 DREADNOUGHT:** This class (and the very similar C8) was designed for extended operations; it is proportionately much larger than the D7. The C9 was designed for use primarily on the Federation border; the C8 being designed for use on the Kzinti border. When the Federation began using fighters, most of the C9s were converted to the C8 (or C9A) configuration.

The C8/9s were very maneuverable ships, and very durable (not only by Klingon standards). It seems possible that most of these ships had their B-refits as part of the original construction.

No interbay (J1.59) shuttle transfers are possible between the rear shuttle bay and the boom shuttle bay. The boom bay cannot be used to drop mines.

UIM: There are two UIM modules as standard equipment; prior to Y165 these were not available and the BPV of a C9 conjecturally built that early is reduced by 10 points. Backups available for purchase under (S3.2).

SSD and Counter in Basic Set.

Variants: C9A Stasis Dreadnought (R3.71) and the Romulan K9R (R4.40).

**(R3.3) C8 DREADNOUGHT:** The C8, better able to protect itself, became the standard Klingon dreadnought throughout the General War and the basis for the later Klingon CVA and SCS designs. This class is 98% similar to the C9, but was originally designed for use on the Kzinti border.

No interbay (J1.59) shuttle transfers are possible between the rear shuttle bay and the boom shuttle bay. The boom bay cannot be used to drop mines.

UIM: There are two UIM modules as standard equipment; prior to Y165 these were not available and the BPV of a C8 conjecturally built that early is reduced by 10 points. Backups available for purchase under (S3.2).

SSD and Counter in Basic Set.

Variants: C8V Heavy Carrier (R3.28), C8S Space Control Ship (R3.70).

**(R3.4) D7 BATTLECRUISER:** This is the standard cruiser of the Klingon Deep Space Fleet. Less expensive than most other heavy cruisers, it lacks the full range of scientific capabilities (reflected in the game by having fewer lab boxes) and crew living conditions are spartan.

In combat, the D7 is noted for its turn mode (better than that of any other heavy cruiser) and for its many transporters, which make hit and run raids, along with boarding party actions, productive for this ship. Because of the large marine complement, D7s (and D6s) often conducted raids and other ground attacks on isolated outposts.

Refits were added to maintain its combat performance. These included the B-refit (improved shielding, drones, and disruptor fire control), the K-refit (improved phasers, first installed on *Thunderchild*), and the Y175 drone rack refit.

UIM: Available for purchase under (S3.2) Y165 and after.

SSD and Counters are in Basic Set.

Variants: D7C Command Cruiser (R3.31), D7V Strike Carrier (R3.44), D7D Drone Battlecruiser (R3.42), D7M Mauler (R3.74), D7E Exploration Ship (R3.43), D7N Diplomatic Cruiser (R3.45), D7A Stasis Battlecruiser (R3.8), the Hydran D7H (R9.18), and the Romulan K7R (R4.35).

**(R3.5) D6 BATTLECRUISER:** This ship was the original Klingon standard cruiser until it was replaced by the more powerful D7. Compared to the D7, the D6 has fewer phasers and the disruptors have a shorter range.

The D6 received a series of refits to keep its combat performance up to the requirements of the time. The B-refit (before the General War) improved the shielding, drone racks, and disruptors. The Y175 refit improved the drone racks. The final and most powerful version was the D6K. (The Y175 refit is included in the BPV of the D6K on the Master Ship Chart.) The first D6K, *Destruction*, was converted in Y175; a few others received their K-refits in subsequent years.

Many D6-class ships were converted to carriers, scouts, or PF tenders, most of which were successful. Several were transferred to the Romulans and used as KR's.

It should be noted, however, that one of the four shipyards building D6/7 class ships never converted to D7 production and continued to produce D6s until almost the end of the General War. The D6 may have originally been kept in production to provide ships for the "light cruiser" or "destroyer" roles; this may have been considered less expensive than designing two new classes. By the start of the General War, most D6 production was used for variants. One of the hidden strengths of the Klingon Empire was the ready availability of cruiser hulls for support variants.

UIM: Available for purchase under (S3.2) Y165 and after.

SSD and Counters are in Basic Set.

Variants: D6V Carrier (R3.21), D6D Drone Cruiser (R3.32), D6M Mauler (R3.33), D6E Exploration Ship (R3.46), AD6 Heavy Escort Cruiser (R3.76), D6S Heavy Scout (R3.47), D6P Fast Patrol Ship Tender (R3.22), D6J Penal Cruiser (R3.36), Romulan KR (R4.4), and Orion OK6 (R8.15).

**(R3.6) F5 FRIGATE:** This class was used for a multitude of patrol and escort duties. While an outstanding frigate design, the lack of a true destroyer in the Klingon fleet (the F5L being used exclusively as a frigate squadron leader) meant that F5 frigates were often used in situations too difficult for a ship of their size but too unimportant for a cruiser. F5s were, however, very easy to build and produced in greater numbers than any other Klingon ship (and arguably in greater number than any ship) excepting only the PFs. The many variants attest to its solid design.

As with other Klingon ships, refits improved combat performance over time. The F5B had improved shielding and drones. The Y175 refit further improved the drone suite. The most powerful combat version was the F5K. (The BPV of the F5K on the Master Ship Chart includes the Y175 drone rack refit). The first F5K, *Wardog*, was converted in Y175; others received their K-refits over the subsequent decade.

UIM: Not available.

SSD and Counters are in Basic Set.

Variants: F5V Light Carrier (R3.30), F5D Drone Frigate (R3.35), F5M Minehunter (R3.27), F5E Combat Escort (R3.77), AF5 Aegis Escort (R3.78), F5S Scout (R3.20), F5C and F5L Leaders (R3.34), F5I Police Frigate, F5J Penal Frigate (R3.38), FX Improved Technology Frigate (R3.41), Romulan K5R (R4.5), and the Tholian TK5 (R7.17). The F6 (R3.64) Battle Frigate was based on the F5 hull, but is considered a separate class. Late in the General War, the Klingons developed the F5W (a true "war destroyer") from the basic F5 design, further attesting to its adaptability.

**(R3.7) E4 ESCORT:** The E4 was the original Klingon frigate design, and it served as the consort to the D6. After Y150, the small frigates, such as the E4, were proving inadequate, and the Klingons increased production of the larger F5 to take over the frigate role. The E4 was relegated to convoy escort duty and, to some extent, police and border patrols. When the General War began, the E4s were quickly absorbed into the main fleet, but by the middle of the war had again been relegated to secondary duties. Disruptor range is 10 on ISF units and 15 on Deep Space Fleet units. The E4 cannot separate its boom section.

UIM: Not available.

SSD and Counters are in Basic Set.

Variants: E4V Escort Carrier (R3.80), E4D Drone Escort (R3.79), E4E Carrier Escort (R3.25), E4A Aegis Escort (R3.25A), E4J Penal Escort (R3.39), and the Romulan K4R (R4.10).

END OF SECTION (R3.0) BASIC SET

**(R4.0) THE ROMULAN STAR EMPIRE**

**(R4.1) ROMULAN BACKGROUND**

Romulans are an off-shoot of the Vulcan race, with pointed ears and copper-based blood (giving them a slightly greenish tinge). The most important thing to the average Romulan is "honor," i.e., their own personal reputation for doing the correct and honorable thing. For some Romulans, however, ambition overcomes honor and replaces it with greed, revenge, or perhaps with hubris.

The Romulans are the most aggressive of the several empires. Their territory includes even fewer habitable planets than the Gorns and no other sentient races. The Romulans seem to honestly believe that they are destined to rule the Galaxy and are constantly working toward this end.

The Romulan government includes the Emperor, the Praetor, the Senate, the Military Command (which includes the various fleets, training command, base commands, and military production), and the Civil Administration (planetary governors, etc.)

The Emperor is a hereditary monarch although the lines of succession are not always clear. Theoretically a new emperor is selected by the members of the ruling House, but if they cannot agree (or if another House claims to be the rightful ruling House), the Senate makes the final decision.

The Praetor is a prime minister who is selected by the Senate. The Emperor may indicate his preference in this selection, and depending on the relative political power of the Senate and Throne, the Emperor may succeed in blocking the election of an enemy or forcing that of a friend. The Praetor may, at any given time, be a bureaucrat who serves as Chief of Staff to an active emperor or the actual power. It was Praetor Karzan who led the Romulans into the First Romulan War (with the Federation).

The Senate consists of the ranking member of the various Houses. A "House" is an extended family of Romulan nobles. Various family members serve in positions within the Military Command and Civil Administration, and a House will attempt to maneuver its members into positions that enhance the power, prestige, and wealth of that House at large. By procedures that seem more Machiavellian than parliamentary, Houses can be divided or merged, new Houses can be declared, and existing Houses can be declared terminated.

Romulan ships, and their military aspirations, can be divided into three groups.

The Old Series are the old Warbird, Hawk, and Snipe types (and their numerous refits, variants, and derivatives), all of which were originally sublight designs. These were the only ships the Romulan fleet had until the Treaty of Smarba with the Klingons in Y159. During this period of time, the Romulans were regarded by the Federation, Klingons, and Gorns as only as a persistent and vicious nuisance.

The Klingons began supplying ships to the Romulans in Y159. These ships, all conversions of ships built by the Klingons, are known as the KR Series. During the period Y160-Y170, the Romulans became a deep space navy in all respects, but their training and professionalism left much to be desired.

With the New Series (Condor, SparrowHawk, SkyHawk, and their variants), the Romulans not only began producing their own excellent ship designs, but they also became a major military power and a significant threat to peace. None of the New Series ships are in Basic Set.

All Romulan ships are assumed to have the cloaking device unless stated otherwise. Note that the presence of this device is noted on the Master Ship Chart. Also note that no Romulan ship (even those purchased from the Klingons) have the capability to perform ship separations.

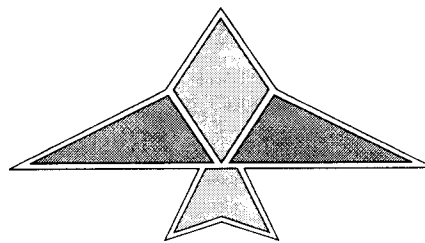

**(R4.R0) ROMULAN FLEET REFITS**

**(R4.R1) KR CLASSES:** Most of the Klingon-supplied ships received refits by about Y170. These refits (designated by a "B" added to the end of the ship designation) include the conversion of fixed type-G torpedoes to swivel (LP/RP) type-S torpedoes and the strengthening of the 3-4-5 shields to equal the strength of the #2 shield. These changes are shown on the SSD.

**(R4.R2) SPARROWHAWK CLASSES PLUS-REFIT:** The first 15 SparrowHawks were built with fixed type-G torpedoes. SparrowHawks built in Y174 or later had swivel type-S torpedoes (and stronger rear shields) and were given the plus designation (e.g., SpH-A+). This data is shown on the SSD. All of the older ships were converted to the plus-upgrade by mid-Y175 (other than those lost in combat); some had the plus upgrade as early as Y172 for combat testing.

**NOTE:** None of these ships are in Basic Set.

**(R4.R3) OTHER CLASSES:** Many of the older (first generation) ships, and some newer ones, were given refits to various extents to incorporate new technology, such as transporters. These are designated with a +, for example the Warbird+. This data is shown on the SSD.

**(R4.R4) OLD SERIES PHASER REFIT:** The advent of Federation fighters caused problems for the earlier Romulan ships, which had no rear-firing phasers. After Y171, many of these earlier ships were fitted with one phaser-3 on the rear of each engine, as seen on the SSDs. The phaser-3 cannot be upgraded to phaser-1. Not all ships of a class received the refit. Ships with this refit are designated with an "R" added to their type, e.g., WER, WHR, BHR, etc. The Falcon received phaser-3s with a different firing arc due to its different mission.

**(R4.R5) MODULAR BPVs:** For purposes of accounting or campaign record keeping, the cost of the various modules can be calculated from the cost of the ship without any modules. (The ship cannot operate without modules; this is simply a means of calculating module costs. The only partial exception would be a transport returning from a delivery mission.)

KillerHawk	= 184	FireHawk	= 139
SuperHawk	= 161	SpH (no refit)	= 90
NovaHawk	= 155	SkyHawk	= 70
RoyalHawk	= 155	SeaHawk	= NA

**NOTE:** None of these ships are in Basic Set.

## ROMULAN OLD-SERIES WARSHIPS

**(R4.2) Warbird (WB):** The Romulan Warbird class is an old type from more than 100 years before the main timeframe of *STAR FLEET BATTLES*. These ships were used during the First Romulan War, and some remain in use. (The shields are a recent improvement not used during the First Romulan War.) All hull boxes are center hull. Note that this ship has armor; see (D4.12).

This ship carries one NSM, which is included in its BPV (M2.72).

When Klingon technology first became available, many Warbirds were refitted as WB+ ships, which have the four phasers, tractor, and the transporter, but not the warp engines, of the WE class.

SSD and counters are in Basic Set.

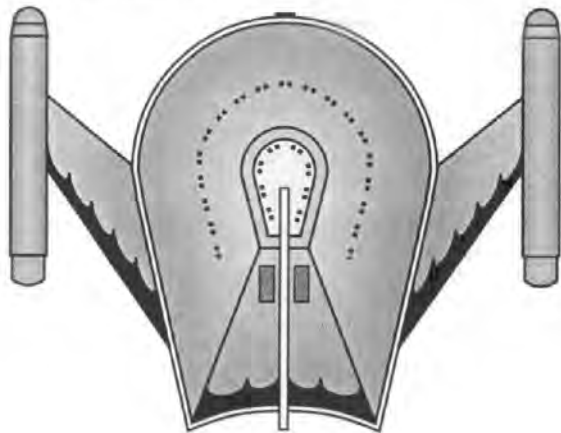

**(R4.3) War Eagle (WE):** The ships of this class are 100-year-old Warbirds converted to use warp power and modern equipment. Note that this ship has armor; see (D4.12). There is only one group of six hull boxes; these are destroyed by both "forward hull" and "aft hull" hits. These ships are critically undersized and, despite the improvement to the War Eagle class, are not capable of standing up in combat to another cruiser. Usually, one good blast from any heavy cruiser is enough to cripple a Warbird or War Eagle.

These ships were kept in service because of the incredible power of the type-R plasma torpedoes. Their saving grace is the cloaking device, which allows the ship to move to close range, fire, and then evade reprisal. This ship carries one NSM, which is included in its BPV.

SSD and counters are in Basic Set.

Variants include the King Eagle (R4.39), Freight Eagle (R4.30), Scout Eagle (R4.12), Pioneer Eagle (R4.53), Commando Eagle (R4.54), and Warbird (R4.2).

## ROMULAN KR-SERIES WARSHIPS

**(R4.4) Klingon-Type Battlecruiser (KR):** In Y159 the Klingons began supplying advanced ships and technology to the Romulans. The most important ships supplied were nine older D6 battlecruisers. While these were strictly second-rate ships to the Klingons, they were at the time the most powerful ships in Romulan hands. Later, the Romulans acquired more D6s from the Klingons and, even later, converted some of their KR into variants.

The KRB refit in Y170 improved the plasma torpedoes and strengthened the rear shields.

SSD and counters are in Basic Set.

Variants include the KRM Mauler (R4.36), KRV Carrier (R4.56), KRP PF Tender (R4.58), KRE Exploration Ship (R4.60), KRG Commando Ship (R4.57), and KRS Scout (R4.59).

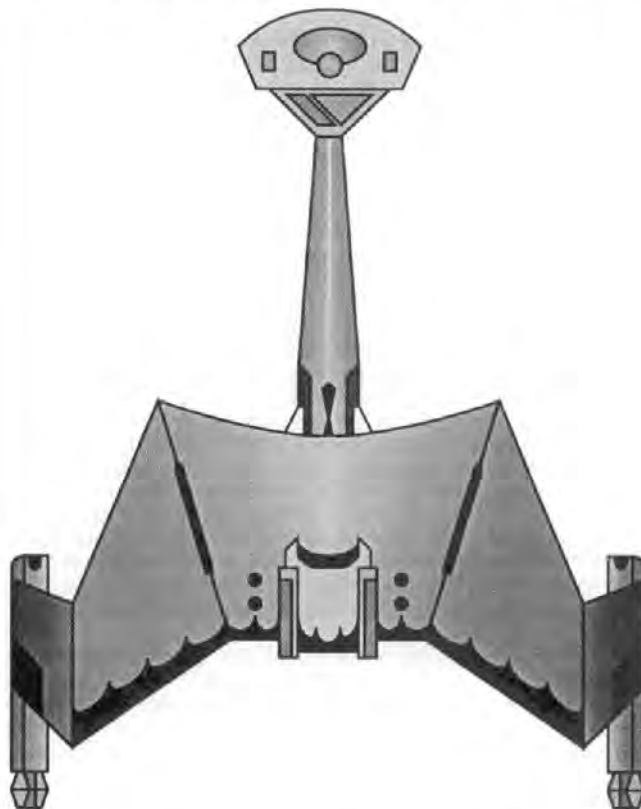

**(R4.5) Klingon-Type Frigate (K5R):** During the period when the D6s were delivered, a number of F5 frigates were also transferred to the Romulans. These were converted into plasma-armed frigates to support the larger ships. Later, some of these ships were converted into variants.

SSD is in Basic Set. Use the Klingon F5 counters. Counters for the K5R are in Advanced Missions.

Variants include the K5S Scout (R4.11), K5M Minehunter (R4.64), K5D Escort (R4.55), and K5L Leader (R4.63).



END OF SECTION (R4.0) BASIC SET

**(R5.0) THE KZINTI HEGEMONY**

**(R5.1) KZINTI BACKGROUND:** Kzintis are large (over 2m tall, over 150kg) humanoids of clear feline ancestry. They are carnivorous, and stories of Kzintis eating their captives are more than often true. This distasteful habit of theirs prevented the Federation from accepting them as allies for many decades.

Their fleet is aggressive and highly professional, but spent much of its time in various civil wars over the succession to the throne. The most notable Kzinti Civil War (Y116) resulted in the flight of the Usurper to the WYN Cluster (R12.0). There were various brief wars with the Klingons, Lyrans, and Federation.

During the war with the Klingons and Lyrans (Y158-162) the Patriarch managed to achieve true control over his domain. In the wake of the war, the Kzintis began a program to improve their ships based on their combat experiences. A border war with the Lyrans in Y168 expanded into the General War.

The Kzinti Hegemony was originally composed only of the Kzinti Homeworlds and a number of nearby habitable systems. Since expanding to its current size, the Hegemony has gained control of several planets with native sentient races, but does not allow individuals of those races to leave their planets. The Kzintis trade with these races, and occasionally smugglers have dealings with them, but they have no spacefaring capability of their own.

Just before the General War (in Y166), the Kzintis signed a treaty with the Federation. This was primarily at the suggestion of the Federation in an attempt to balance the Kzintis against the Klingons. Federation technology did much to help the concurrent fleet-wide refit program.

The Kzinti government is a monarchy; the ruling hereditary sovereign is known as the Patriarch. There are four principal divisions of Kzinti territory, each ruled by a hereditary noble. These are known as the Duke (Klingon border), the Marquis (Federation border), the Count (Lyrans border), and the Baron (who controls a region of newly explored territory with no hostile borders). These titles are approximate Earth translations, and the four nobles rank among themselves in the order given (Duke highest, Baron lowest). There is also (sometimes) a Crown Prince, who is the heir apparent (designated successor) to the Patriarch. These five nobles form a council known as the Pentarchy, which advises the Patriarch.

**(R5.R0) KZINTI FLEET REFITS**

Beginning in Y166, the Kzintis refitted and improved most of their ships. These refits comprised a series of fleet-wide comprehensive (hence "C") upgrades and improvements. Ships with these refits are generally designated with a "+" at the end of their designation. Some (BC, CVS) are listed as separate types.

**(R5.R1) C-14 FLEET REFITS:** Beginning in Y166, the Kzintis refitted many of their CS-class ships (and from Y170 their CVL-, and CV-class ships) with improved weapons. This refit pattern is known collectively as the "C-14 refit." This refit included extra disruptors, improved phaser and disruptor arcs, the installation of the DERFACS fire control system, an increase in the power of the warp engines, and extra shields. This refit is shown and explained on the SSDs of the relevant ships. These ships received DERFACS in Y168. There is no cost reduction prior to that time.

**(R5.R2) C-12 FLEET REFITS:** These refits were applied to the CL- and CVE-classes concurrently with the C-14 refit. It was similar in some regards, including the increased disruptors and the improved firing arcs. It also included extra power and drone racks. This refit is shown and explained on the SSDs of the relevant ships.

**(R5.R3) C-10 FLEET REFITS:** These refits were applied to the FF-class, adding drone racks and shielding. This refit is shown and explained on the SSDs of the relevant ships.

**(R5.R4) C-8 FLEET REFITS:** These refits were applied to the MS, DF, SF, and Pol versions of the frigate. This series of refits is identical to the C-10 series except that the drone racks are not added. This refit is shown and explained on the SSDs of the relevant ships.

**(R5.R5) DRONE RACK REFIT:** As the General War went on, the old type-A drone rack was found less and less suitable for the evolving

combat situation. The Kzintis upgraded the drone racks on their ships (including pods and auxiliaries; bases have H-racks and are not included) at about the start of Y175. All anti-drones were improved to hold 12 rounds (cost 1.5 points each); all type-A drone racks were converted to improved types as follows: The first two type-A drone racks on any given ship are converted to type-C; all subsequent type-A drone racks are converted to type-B (cost 1 point each). Unless otherwise specified, all ships have double drone reloads (no cost for the basic drones, speed and module costs are extra) as part of this refit. It is assumed that this refit applies to all Kzinti ships as of 1 Jan Y175; it is shown on the SSDs of the relevant ships. This refit does not apply to PFs. D-racks on bases are also not covered by this refit.

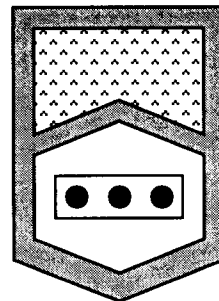
**KZINTI WARSHIPS**

**(R5.2) STRIKE CRUISER (CS):** This ship was the standard cruiser of the Kzinti fleet until most of them were converted to the later battlecruiser design (see below). It relies on drones for its primary armament.

Like all Kzinti ships before about Y160, it fought more battles against fellow Kzintis than foreign enemies, so its shortcomings were not fully realized. It is slightly faster than the Federation and Klingon cruisers when those ships are arming weapons, but this is because the CS has fewer weapons to arm.

The strike cruiser is considered a variant of the BC for game purposes, even though the reverse is actually true.

SSD and counters are in Basic Set.

**(R5.3) BATTLECRUISER (BC):** During Y160 the Kzintis overhauled one of the strike cruisers and modified it to this improved configuration. The design proved so successful that a refit program (R5.R1) was begun in Y166, and by the end of the decade, all strike cruisers in service were converted to battlecruisers. All strike cruisers built from Y166 were completed as battlecruisers.

The BC has as many disruptors as the Klingon and Lyrans cruisers, plus its excellent drone racks. This allows it to use a wide variety of tactics.

Variants include the CS (R5.2), CC (R5.4), CVL (R5.9), CD (R5.47), CA (R5.48), and SR (R5.37).

SSD is in Basic Set. Use the CS counters. Counters for the BC are in Advanced Missions.

**(R5.4) COMMAND CRUISER (CC):** This ship is a specially modified cruiser with improved communications and command facilities, as well as more power and weapons.

The CC was an extremely powerful ship and was vital to the salvation of the Hegemony during the early wars with the Klingons and Lyrans as it could engage the best enemy cruisers on equal terms. The CCs were often used as flagships (for the Patriarch, Count, Duke, Marquis, Baron, and Crown Prince) before the advent of the CV and DN. Some analysts attribute the long delay in the introduction of the BC to the fact that Kzinti nobles served exclusively in the CCs before the Fourth Klingon-Kzinti War of Y158-Y162; the nobility credited the CC's success to a presumed "Noble Superiority" rather than technical advantages. Other analysts suggest that the Kzinti nobility, with the memory of the Usurper War (Y116) still fresh in their minds, did not want any non-nobles flying ships equal to theirs.

This ship can control a number of seeking weapons equal to double its sensor rating.

SSD is in Basic Set. Use the CS counters. A counter for the CC is in Advanced Missions.

**(R5.5) LIGHT CRUISER (CL):** This ship was designed to support the strike cruisers and replace them on less critical missions. The Kzintis, who lacked enough destroyers (and their frigate was too small for most of the traditional destroyer missions), used this ship extensively.

Unmodified CLs served as escorts for some carriers until dedicated escort variants became available. CLs went out of production when the CM was designed. Existing CLs finished out their days as warships; some were converted to CVEs. There may have been other variants, but the data is unclear.

The C-10 refit (CL+) in Y166 greatly improved the ship. Prior to this refit, the disruptors are limited to a range of 22.

Variants include the CVE (R5.10).

SSD and counters are in Basic Set.

**(R5.6) CARRIER (CV):** One of the earliest pure carrier designs, this ship supported Kzinti squadrons in major operations. This ship can control twice as many seeking weapons as its current sensor rating and can assume control of the drones fired by its fighters. The CV was slow and underarmed, drawbacks corrected by the C-14 refit which resulted in the CVS.

The bay has a forward hatch on the face of the lower hull and a rear hatch on the belly. Shuttles can launch from or land in either hatch, but the normal procedure is to launch from the forward hatch and land in the rear one.

YEAR	ESCORTS	FIGHTERS
Y166-67	None	12xAAS
Y168-71†	CL, EFF	12xAAS

† It is thought that all CVs had been converted to CVSs by this time. Had any continued beyond that point, they would probably have had the fighters and escorts of the CVS although they might have kept the fighters and escorts listed above through Y174.

The CV is considered to be a variant of the CVS for game purposes, even though the reverse is actually true.

SSD and counters are in Basic Set.

**(R5.7) STRIKE CARRIER (CVS):** At the start of the General War, most of the existing CVs were given the C-14 refits. The resulting ship was known as a strike carrier. Even without its fighters, it is easily the most powerful Kzinti ship in Basic Set.

Strike carriers, with their fighter groups, were the backbone of the Kzinti fleet during much of the General War. They served as fleet flagships in the absence of capital ships. The CVS is one of the most powerful Kzinti combat ships, nearly equal to the late-war heavy battlecruisers, and its fighters (especially the HAAS and TAAS) form a powerful extension of its firepower. Like most strike carriers, it faced the dichotomy of being too powerful to leave out of a fleet battle and too valuable to risk in one.

When operating with only its escorts, the CVS would attempt to send its fighters around the enemy, trapping him between the disruptors of the carrier and the drone swarm of the fighter squadron.

The bay has a forward hatch on the face of the lower hull and a rear hatch on the belly. Shuttles can launch from or land in either hatch, but the normal procedure is to launch from the forward hatch and land in the rear one.

YEAR	ESCORTS	FIGHTERS
Y170-72	MEC, EFF	12xAAS
Y173-74	MEC, EFF	12xHAAS
Y173-74	MEC, DWE	12xHAAS
Y175-76	MAC, AFF	12xHAAS
Y175-76	MAC, DWA	12xHAAS
Y177-80	MAC, DWA	12xTAAS
Y180+	MAC, DWA	12xTADS

Many of the above escorts and fighters are not in Basic Set. Basic Set players should use this carrier with escorts of one CL and one EFF and with 12 AAS fighters. The SSD shows TAAS and TADS fighters with enough information to use them if you wish.

Variants include the BCH (R5.43) and CV (R3.6).

SSD is in Basic Set. Use the CV counter. A counter for the CVS is in Advanced Missions.

**(R5.8) FRIGATE (FF):** This ship was designed for escort and patrol duties. While a natural enemy of the Klingon F5 frigate, the Kzinti frigate is not powerful enough to defeat it unless commanded by a superior captain. The advent of faster drones did much to improve this situation, but the FF remained mediocre until upgraded to the FFK (or replaced by the DW). The frigate was the basis of several variant classes, including scout, minesweeper, and long-range drone types.

Variants include the SF (R5.18), MS (R5.21), FFH (R5.41), FFK (R5.46), EFF (R5.20), AFF (R5.20A), DF (R5.23), POL (R5.36), SDF (R5.55), and the WYN Kz-FF (R12.4).

SSD and counters are in Basic Set.

**NOTE:** The following units are presented out of the normal numerical sequence because they are needed for the operation of the carriers.

This reflects part of the problem in converting the previous Commander's Edition to the Captain's Edition. When the carriers were first introduced into the game (back in the Designer's Edition of 1980), they did not have formal escorts, and by the time these were provided, the intervening numbers had been filled with new ships.

Science fiction purists may prefer to ignore fighters as they did not appear in the original background. In this case, simply delete the fighter boxes on the CVS and use it as a heavy battlecruiser. Purists would probably prefer to ignore Module J as that includes many fighters and carriers. Several more carriers are included in other products; you can use these (to varying extents) as standard warships by deleting the fighter boxes.

**(R5.20) ESCORT FRIGATE (EFF):** Designed to provide increased protection from drones for carriers (and their returning fighters). See (R5.20) in Advanced Missions for additional data.

SSD is in Basic Set. Counters are in Advanced Missions. If you do not have Advanced Missions, use the FF counters.

**(R5.F2) AAS FIGHTER:** The Advanced Attack Shuttle was the result of a Kzinti research program to build a fighter that could control its own drones.

This fighter is treated as a shuttle except that:

- It has a speed of 8.
- It has one phaser-3 with an FA firing arc.
- It carries two type-I drones.
- It is destroyed by 8 damage points.
- It has a BPV of 6.



TADS

AAS

Most Kzinti SSDs have TADS fighters, requiring minor changes to reflect AAS fighters. Delete all of the drones except the type-I's, one chaff pack, and four damage points.

**END OF SECTION (R5.0) BASIC SET**

**(R6.0) THE GORN CONFEDERATION****(R6.1) GORN BACKGROUND**

Gorns are reptilian-humanoids with a high degree of intelligence and personal bravery. They are physically as large as (or larger than) Kzintis, being taller than (and with perhaps twice the bulk of) Humans.

The Gorn Confederation consists of three sentient races (all developed on separate planets but are so nearly identical they must have come from common stock) joined into a single political unit. Their area of space includes relatively few habitable planets and, apparently, no native sentient races beyond themselves.

The Gorns first met the Federation in war, but this was quickly settled when it became apparent that it had been a misunderstanding. During the peace talks, the Federation discovered that the Gorns had experienced a continuing series of armed disagreements with the Romulans concerning their common border, and a Federation-Gorn alliance was formed. The Federation-Gorn Alliance seems to be the only one that is based on mutual trust and respect and a common desire to end all military aggression. Other Alliances (Federation-Kzinti, Romulan-Klingon) are based on political expediency.

The Gorn fleet is small compared to the Romulans, but of high-quality ships. Before the General War, the Gorn ships were typified by relatively few heavy weapons. This was adequate against the sublight Romulan ships, but proved marginal against warp-capable KRs. The Gorns refitted their ships with more and heavier plasma torpedoes, greatly increasing their combat power.

All Gorn ships have a Federation reporting name, a sort of "nickname" by which it could be cited in reports and studies. These names were first assigned during a time when the Gorns were on less than friendly terms with the Federation, and the fact that the practice continued may indicate something about the Federation bureaucracy. These names were dinosaur species from ancient Earth history, a fact that the Gorns found thoroughly amusing.

**(R6.R0) GORN FLEET REFITS**

**(R6.R1) GORN "+" REFITS:** Starting about Y170, the Gorns refitted most of their ships that carried fixed type-G plasma torpedoes with type-S torpedoes on swivel mounts. This is known as the "plus refit," and all ships which have it are noted as such. Many of the newer ships were originally built with type-S torpedoes. This refit increases the BPV of the ships by 8 points per torpedo.

Most Gorn SSDs include this refit; a note explains how to remove it if the ship is being used before the refit date.

The SSDs of those ships eligible to receive this refit are marked appropriately. Ships unable to receive the refit do not have it on their SSD. Those ships which received it only rarely have it on their SSD with an appropriate note in the ship description.

Some ship classes received various improvements at the time of their plus refits, which are shown on their SSDs. For example, the destroyer received additional shields, reactors, and batteries.

**(R6.R2) GORN "F" REFITS:** Starting about Y175, the Gorns refitted many of their ships with two type-F plasma launchers (one on either wing) and two phaser-3s (one on either wing) to provide increased protection from fighters and fast patrol ships. Ships with this revision (which already have the "+" refit if applicable) are known as, for example, CLF or DDF. The CA, when modified to this configuration, was called the battlecruiser or BC. This refit increases the BPV of the ship by 14. The terms "fleet destroyer" and "fleet light cruiser" are also used.

The SSDs of those ships eligible to receive this refit are marked appropriately. Ships unable to receive the refit do not have it on their SSD. Those ships which received it only rarely have it on their SSD with an appropriate note in the ship description.

**(R6.R6) SHUTTLE BAYS:** Virtually all Gorn ships have two shuttle bays on opposite sides of the ship. There is a connecting passage (J1.59) between them, which is also how T-bombs and spare shuttles are brought to the bay. Some ships (e.g., the carriers) have one large bay with doors exiting from both sides of the ship.

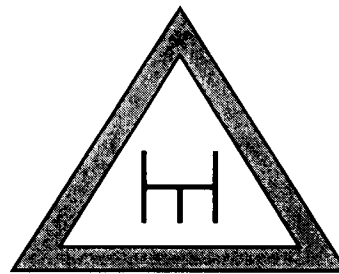
**REFITS FOR GORN SHIPS  
IN OTHER PRODUCTS**

All of these refits apply to ships, systems, or rules introduced in later products. The new player should ignore them for the time being.

**(R6.R3) GROUND ASSAULT SHUTTLES (GAS):** The Gorns, with their notorious penchant for ground combat, carry some GAS shuttles as standard equipment on their ships. These are noted on the SSD (by the description "GAS" on the shuttle record track).

As ground assault shuttles are introduced into the game system by Module M (Star Fleet Marines), the difference can be ignored for purposes of Basic Set. GAS shuttles function as admin shuttles but have some additional capabilities for landing troops.

**(R6.R4) HEAVY DESTROYER:** The heavy destroyer (and most of its variants) received a refit in Y175 which is noted on its SSD. While described as the "plus" refit (i.e., HDD+, HDP+, etc.), this refit is different from the standard plus refit seen in (R6.R1). Some variants only received the shield portion of this refit as they already had the extra phasers.

The heavy destroyer is found in Advanced Missions, and many of its variants are in Module R4, so this note can be ignored by the new player.

**(R6.R5) D-REFIT:** This refit was installed in place of the F-refit on certain ships, such as carrier escorts. The only difference is that the ship received two type-D plasma torpedo racks instead of the type-F torpedo tubes. These are shown on the SSDs of the various ships involved. The choice between the D-Refit and the F-refit was made by the fleet commanders and is not in the hands of the players.

The type-D plasma torpedo and its launch rack are found in Advanced Missions. The various ships which can use this weapon are found in other products. This refit can be ignored by new players who have only Basic Set.

## GORN WARSHIPS IN BASIC SET

**(R6.2) HEAVY CRUISER (CA):** This is the standard workhorse cruiser of the Gorn fleet. It has two plasma-G torpedoes, with fixed launch directions angling to either side. This lack of concentrated firepower made the ship awkward to use in battle although its powerful phaser suite partially made up for this problem.

The standard tactic for these unrefitted fixed-tube Gorn ships was to cycle the torpedoes to be ready at different times. The ship would make a pass toward one side of the enemy, firing the torpedo on that side, then turn away and circle to pass the enemy on the other side, firing the second torpedo. This worked well enough against the old-series Romulan ships, but became a critical problem as more powerful ships came into service with the Romulan fleet.

The eight center hull boxes can be destroyed either forward or aft hull hits.

With the plus and F-refits, standard in this class, the ship is known as the BC or battlecruiser.

Federation reporting name: *Allosaurus*.

Balcony positions: 3 left + 3 right.

SSD and counters are in Basic Set.

Variants: Battlecruiser (R6.19) and Command Cruiser (R6.18).

The Gorns, unlike other races, built very few variants of their heavy cruiser class.

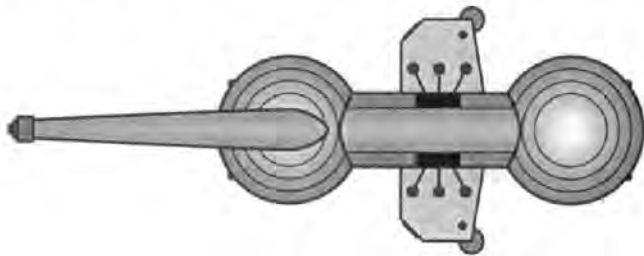

**(R6.3) LIGHT CRUISER (CL):** The CL was designed by the Gorns to use as many components of the CA as possible. One look at the SSD will show you that this is simply a CA with the rear disk removed, or rather, it is a CA to which the rear disk was never added. While this made construction easier (and conversion to CA/BCs possible), the ship is not optimally balanced for its mission. Nevertheless, it is a good ship for most situations.

Federation reporting name: *Megalosaurus*.

Balcony positions: 2 left + 2 right.

SSD and counters are in Basic Set.

Variants: Large Scout (R6.10), Carrier (R6.16), Escort Cruiser (R6.38), Commando Cruiser (R6.29), and Survey Cruiser (R6.30). During the war, many CLs were converted to BCs.

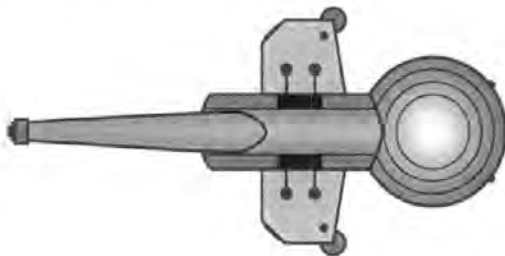

**(R6.4) DESTROYER (DD):** The Gorn destroyer was a powerful antagonist when built, carrying as it did the heavy type-G plasma torpedo. While the torpedo was fixed and could only be fired directly ahead, the 120° tracking arc made this only a minor limitation.

Like the CA/CL, the destroyer was designed to allow the later addition of another disk, resulting in the Battle Destroyer (R6.17). The fact that this expansion was provided for may indicate why the Gorns produced an obviously inadequate destroyer design. The DD is, in fact, a very good frigate.

As Romulan ships improved and new enemies appeared, the destroyer was extensively rebuilt and upgraded with the plus-refit in Y170, which (as can be seen on the SSD) added considerable power to the ship. The further F-refit added two type-F torpedoes and placed considerable strain on the small hull. Standard production shifted to the Battle Destroyer (R6.17) while existing destroyers were used for variants or converted to BDDs.

The type-G torpedo cannot be upgraded as the hull could not stand the shock of firing a type-S.

Ship designed by *C H Graeme Cree*.

Federation reporting name: *Carnosaurus*.

Balcony positions: 2 left + 2 right.

SSD and counters are in Basic Set.

Variants include the Scout (R6.13), Minesweeper (R6.15), PF Tender (R6.14), Destroyer Leader (R6.32), and Destroyer Escort (R6.37). The Battle Destroyer (R6.17) is considered a separate class.

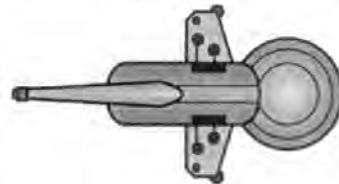

END OF SECTION (R6.0) BASIC SET



**(R7.0) THE THOLIAN HOLDFAST****(R7.1) THOLIAN BACKGROUND**

The Tholians are not native to our galaxy, but migrated here from another. They are the survivors of a race that once dominated their native galaxy, the exact location of which is unknown. The subject races of the former Tholian Empire rose in a galaxy-wide revolt some 200 years ago, overthrowing the Tholian dictators. The Tholians of our galaxy are the descendants of a group that escaped the debacle and managed, by means yet unknown, to bring their planet (which was a provincial capital and a small Dyson sphere) with them.

Tholians are crystalline creatures who exist in very high temperatures. It can be assumed that boarding party actions employ special environmental suits for one or both sides.

They settled on the edge of our galaxy at the end of the spiral arm that includes the Klingon homeworld. The Klingons had claimed this territory (and the Federation had tacitly accepted the claim), but the Klingons had not colonized it extensively. The Tholians now claim it as their own and defend it fiercely, which explains the considerable hatred between them and the Klingons. The Federation has turned a deaf ear to Klingon requests, through diplomatic channels, for repatriation of the colonists and base crews from the area. It is doubtful that any survived the Tholian arrival.

The Klingons could probably crush the Tholian Holdfast at will, but have been unable to spare enough ships to do so without dangerously weakening their other frontiers. Also, the Federation has announced that it will not tolerate aggression against the Tholians. This would presumably involve Federation fleets operating in neutral or Klingon territory since foreign forces are not welcome inside the Holdfast. The Tholians have denounced Federation assistance and declared strict neutrality, but are fully aware that their survival in a crisis would depend on Federation assistance. The Tholians are masters of playing off one side against the other; the first principle of war taught in their academy is "Let's you and him fight."

The Tholians suspect that some of their former subjects may be looking for them and want to avoid becoming noticeable. No evidence of such search missions was known to the Federation prior to the General War. The Andromedans have definitely been ruled out. It is not known if the searchers are operating in a clandestine mode, haven't searched this far yet, or aren't searching at all. The Tholians aren't taking chances.

The Klingons, in an effort to keep pressure on the Tholians without starting a war with the Federation, maintain a strong squadron of ships (the famed Tholian Border Harassment Squadron) in the area and create incidents on a regular basis. Klingon ships are rotated through this squadron for combat training.

The Tholians never attack anyone and venture into neutral territory only rarely. There is no pirate activity inside the Holdfast and no smuggling across its border. Incidents with the Romulans have been reported, but by and large the Romulans prefer to leave the Tholians alone; the Romulans have enemies enough.

During the General War (Y168-Y185), the Tholians became considerably more cooperative with the Federation and its allies. During one period, Gorn and Kzinti ships were allowed into the Holdfast to assist in its defense. (Federation ships were excluded because the Tholians did not want to provide any more information than necessary to their most powerful neighbor.) During one period a small Tholian force was sent into the Federation (see Operational Cavalry, scenario SH11) to assist in an attack on the Klingons. The Tholians continually harassed the Klingons and Romulans, tying down Coalition ships needed elsewhere. Their greatest contribution to the war effort was to block the lines of communications between the Klingons and Romulans, isolating the Romulans and allowing the Alliance to nearly drive them out of the war.

The use of webs by the Tholians is thought to stem from the advanced electromagnetic systems that they developed to move an entire planet. All other Tholian weapons are identical to existing Federation or Klingon types. It is not known if these are copies or native to the Tholian race.

The Tholians use only ships with hulls the size of the PC-class (or with two or three of them welded together) because the only forging facilities they have are those of the former provincial capital. Such a facility was never intended to build heavy starships. Larger ships were presumably built at a few centralized shipyards.

This points out the single most important facet of the Tholians. They are not an entire race, but only a group (albeit over a billion individuals strong) of refugees. There is simply no one available who knows how (or has been able to figure out how) to design a forge to cast larger hull plates. The Tholians have electronic gear that they can build but do not know how to repair, weapons that they can understand and maintain but do not have the skills to build, and automatic machinery programmed to turn out copies of devices that they could never design.

*Tholian background created by the Reverend Ron Wheeler.*

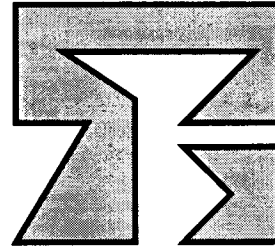

**(R7.R0) THOLIAN FLEET REFITS**

**(R7.R1) PHOTON TORPEDO REFITS:** This refit is in Module R4.

**(R7.R2) WEB CASTER REFITS:** This refit is in Module C2.

**(R7.R3) COMBINED REFITS:** This refit is in Module C2.

**(R7.R4) SNARE REFITS:** This refit is in Module C2.

**THOLIAN WARSHIPS**

**(R7.2) PATROL CORVETTE (PC):** When the Tholians arrived in our galaxy (Y79?), their only shipyard was unable to build anything larger than this ship, which was considered a police frigate in their own galaxy. While highly maneuverable and packing a good punch (four phaser-1s), it lacks secondary weapons and cannot fire to the rear. It also has web generators, which are used to capture or slow down enemy ships. Fighting from behind webs, these ships successfully protected the Holdfast for more than 60 years, until the heavier cruiser design appeared.

It is sometimes called the "Patrol Cruiser."

Variants include the PC+ (R7.3), Destroyer (R7.4), Black Widow (R7.7), PF Tender (R7.8), Cargo Patrol Corvette (R7.11), Scout (R7.12), Minesweeper (R7.13), Disruptor-Armed Patrol Corvette (R7.16), Patrol Escort (R7.28), Patrol Aegis Escort (R7.29), PR Repair ship (R7.18), and Commando Ship (R7.26).

SSD and Counters are in Basic Set.

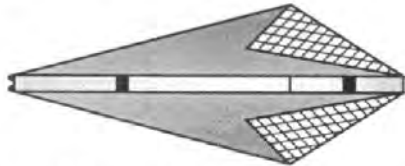

**(R7.3) IMPROVED PATROL CORVETTE (PC+):** This is a minor modification to the standard PC, replacing the web generators with phaser-3s and with a larger impulse engine for more power. It is otherwise identical to the PC.

PC+ ships, which gave up their ability to lay web, were used as squadron flagships (teamed with two standard PCs). They provided the formation with a slightly improved combat capability that was, generally, inadequate.

SSD is in Basic Set. Use the PC counters.

**END OF SECTION (R7.0) BASIC SET**

**(R8.0) THE ORION PIRATES**

**(R8.1) ORION BACKGROUND**

The Orion Pirates are difficult to describe as a political entity. Orion is a member of the Federation, and one of the most economically aggressive, both within and outside Federation territory. Officially (according to the Orion Government, anyway), the pirates are simply individual privateers and criminals, many of whom are not even Orions, with no formal organization.

It is believed that the original Orion Pirates were a clandestine arm of the Orion government, using ships provided to them and manned by regular officers and crewmen of their own fleet. Since the early years, however, the Orion Pirates have extended their operations to cover most of the known areas of the Galaxy. The pirates are organized into cartels, each controlling all pirate operations in a given area. Many ships are operated by each cartel, and many other ships are independent of all cartels. These independent ships lease an operations area from a cartel lord and purchase their needed supplies, weapons, and maintenance from cartel facilities.

Orion ships have Federation-supplied code names (Marauder, Privateer) for reporting purposes, but within the game the generic (salvage cruiser, light raider) terms are in general use. The Raider and Buccaneer are exceptions to this.

The pirates are not a standard fleet and as such have certain special rules, most of which are detailed under (G15.0). Study that section carefully as most Orion special rules (e.g., optional weapons, suicide bombs, engine power doubling) are found there.

No Orion unit of any type ever had a phaser-4. Orion bases, including ground bases, substitute phaser-1 for phaser-4 as provided in the descriptions.

Due to the nature of their operations, the Orions did not need or produce a dreadnought, monitor, police ship, exploration ship, scout, tug, or minesweeper although some of these functions could be approximated with option mounts.

The Orions have divided up the known areas of the galaxy into operating zones, each controlled by a cartel. Each cartel has the exclusive right to "harvest resources" (i.e., piracy, smuggling, etc.) within its territory. Each cartel has a number of enforcer ships (including at least one CA) to enforce this control. Each cartel also owns a number of piracy and smuggling ships which operate within its territory to produce a profit for the cartel.

About 2/3 of all Orion ships are "independent" ships not owned by any cartel. These ships "lease" an operating territory from the cartel. The cartel will attempt to maximize profits while not conducting enough operations in any given area to attract attention of the local fleet.

**NOTE ON CAPTURING SHIPS:** Orion players are directed to (D7.50) which lays out the procedures for capturing a ship with boarding parties. Note that even freighters have control stations (Bridge, Aux, Emer), and these must be captured (D7.36) before the ship is captured.



CARTEL	HOME TERRITORY	OPERATING ZONE
Cluster	WYN	Kzinti, Lyran, Klingon
Daven	Klingon	Hydran, Lyran, Kzinti, Fed, LDR
Hamilcar	Klingon	Hydran, Federation
Lion's Heart	Federation	Kzinti
Pharoah	Federation	Klingon, Romulan
Dragon	Federation	Federation
Penzance	Federation	Romulan
Stardust	Gorn	Federation, Romulan
Omega	Gorn	ISC
Kublai	ISC	Gorn, Romulan
Cirentus-Ta	Romulan	ISC

In each case, the Operating Zone of any given cartel includes the Home Territory for that cartel.

The Capital Cartel is also known as the Dragon Cartel. In previous editions, Cartels were incorrectly called Clans.

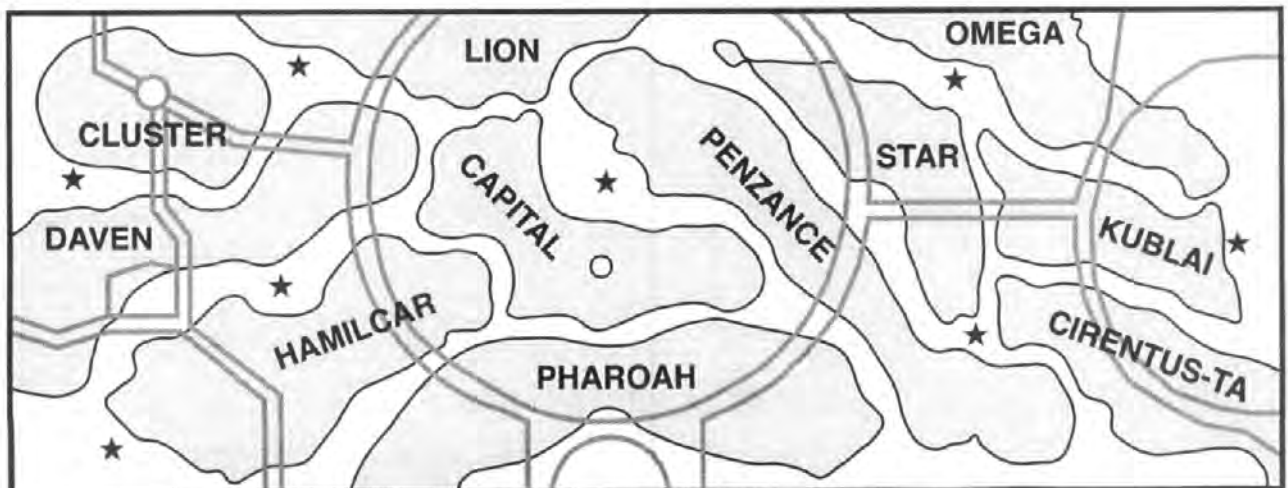

**(R8.R0) ORION FLEET REFITS**

**(R8.R1) MINELAYER REFIT:** Orion ships are capable of carrying mine racks in their shuttle bays; each rack replaces a shuttlecraft. While these would almost never be used during a scenario, they could be used to lay a minefield in the path of a convoy or to mine the area around the local pirate base (either on contract or to block the reaction of police forces to a raid by other pirates). The mine racks cost one point each as if they were being placed in an option mount and there is no rebate for the shuttle that is lost. The mine rack is empty, and the mines would have to be purchased separately, but there is no other restriction. Any other player could buy a minesweeper and the mines for it.

**(R8.R2) DRONE RACKS:** As the General War went on, the old type-A drone rack was found less and less suitable for the evolving combat situation. The Orions upgraded the type-A drone racks on its ships (including pods and auxiliaries, but not including bases which have H-racks and separate rules) at about the start of Y175. All type-A drone racks were converted to type-C (cost 1 point each). Unless otherwise specified, all ships have double drone reloads (no cost for the basic drones, speed and module costs are extra) as part of this refit. It is assumed that this refit applies to all Orion ships as of 1 Jan Y175. This does not apply to PFs.

**(R8.R3) OPTION MOUNT FIRING ARCS:** Firing arcs for Orion wing option mounts:

Photon, disruptor, fusion .....	FA
Disruptor, fusion.....	L+LF/RF+R
Phaser, Plasma-D .....	LS/RS
Plasma-F torps.....	LP/RP
Drone, anti-drone.....	360°
Hellbore, PPD .....	Not allowed.

All forward centerline option mounts are FA (FP for plasma torpedoes) except drones and ADDs (360°).

**(R8.R4) CLOAKING DEVICE REFIT:** Many Orion ships (but only a minority) were equipped with cloaking devices to enhance their clandestine operations. The cost in BPV and cost of operation are shown on the SSD for each ship.

**(R8.R5) PLASMA RACK REFIT:** Orion ships using Romulan, Gorn, or ISC territory as "home" territory can replace their drone racks with plasma racks (FP10.0). The BPV is increased by 2 points per rack converted.

**(R8.R6) SHIELD REFIT:** The shielding of the pre-war ships (CR, LR, CA, and the SAL series) was increased between Y169 and Y174, generally as war came to the various operating theaters and a good many more naval warships were actively operating. These refits are shown on the SSDs as the "plus refit" for these classes.

**ORION WARSHIPS**

**(R8.2) LIGHT CRUISER (CR):** The Raider-class light cruiser was the backbone of the Orion Pirate forces during the period before the General War. It is equivalent to the light cruiser of most fleets in firepower although (like all Orion ships) it quickly becomes combat ineffective when damaged. It is an excellent ship for its purpose: attacking cargo ships. While most pirates prefer to prey on unprotected ships, this vessel can defeat or disable most pre-war escorts.

Federation codename: *Raider*.

OAKDISC cost = 5 points.

This ship can use the gravity and aerodynamic landing systems (P2.43).

This ship is nimble (C11.0).

Variants include the Medium Raider (R8.21).

SSD and counters are in Basic Set.

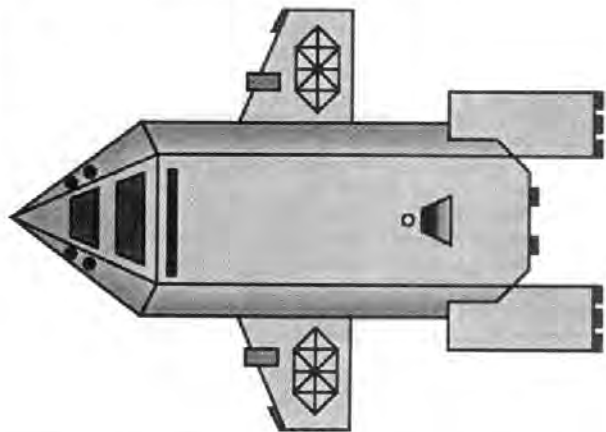

**ORION CR:** Note the bridge structures (the rhoboids on the front slope), the sensor array (the black bar at the front of the main hull), the tractor beams (the rectangles on the wing leading edges), the passive sensor detection grids (used to avoid contact), and the sloping hatch down into the shuttle bay.

**END OF SECTION (R8.0) BASIC SET**

**(S0.0) SCENARIOS****(S1.0) GENERAL RULES**

The game *STAR FLEET BATTLES* includes several scenarios, each representing a battle situation in which the players will use their ships, weapons, and skills to defeat an opponent. The term "scenarios" is synonymous with "situations" and "battles" in this sense. There are several types of scenarios, as will be explained below.

**(S1.1) SCENARIO ORGANIZATION**

Scenarios, for the most part, are presented in a set format. (This format is also used for scenarios presented in Advanced Missions, the modules, and other places.) This format is explained below.

**(S★.0) SCENARIO TITLE:** Each scenario has a title that identifies the battle it portrays. Included here is background information about the battle, often describing the situation and what you are trying to accomplish. This section will also include the scenario author and (in a historical scenario) the date. There will also be a graphic illustrating the ships used in the scenario, allowing you to quickly find a scenario with the number and type of ships you wish to use.

**(S★.1) NUMBER OF PLAYERS:** Most scenarios are designed for two players, but some are designed for one and others for three or more. In this section, each player is identified; this identification is then used throughout the scenario.

**(S★.2) INITIAL SET UP:** This section will give the starting position (or area and/or time of arrival) for all units (and anything else, such as a planet) involved in the scenario. Included will be not only the location but also the speed and heading (the direction it is moving) and the status of each ship's weapons (S4.1).

In all cases, the speed given is the speed that the ship was using during a hypothetical previous turn for purposes of acceleration; see (S1.42). The maximum possible speed of the ship may not be exceeded. If a scenario calls for a ship (perhaps as a substitution under a variant) to have been moving at a speed faster than it can move, players should adjust the stated speed downward to this limit. If a faster ship is substituted, retain the original speed.

Ships placed on the map at the start of the scenario, or which enter the map during the scenario, are assumed to have fulfilled their turn and sideslip modes provided it is possible for them to have done so. Exception: Units at a speed of zero have not fulfilled any turn or sideslip mode (C3.43). Additional exceptions may be stated in various scenarios.

Weapons status (S4.0) defines how the weapons of the various ships may be armed at the start of the scenario. Note that weapons status applies only to the condition of the weapons at the start of the scenario (or when new units appear); it does not restrict what you do with the weapons during the scenario.

**(S★.3) LENGTH OF SCENARIO:** In most cases, the scenario ends when one player's forces have either been destroyed or forced to leave. This is not always the case; if it is not, directions will be given.

**(S★.4) SPECIAL RULES:** Many scenarios include special rules that reflect the tactical situation.

**(S★.5) VICTORY CONDITIONS:** This section will describe how to determine who won the scenario. Standard victory conditions (S2.20) will be used unless superseded by specific instructions in the scenario.

**(S★.6) ORDER OF BATTLE VARIATIONS:** In many cases the scenario can be played many times with different forces. How a Klingon ship, with its distinctive weapons arrangements, handles

a situation or opponent may be substantially different from how a Federation ship handles it. Reading the variations sections of several scenarios will give you ideas that can be applied to others.

**(S★.7) BALANCE:** In some scenarios, suggestions on how to balance the scenario between players of unequal skill are given. Reading the balance sections of several scenarios will give you ideas that can be applied to others.

**(S★.8) TACTICS:** If the situation is unusual, advice on tactics may be provided. Note that this is only a guide for the first time you play the scenario; you will develop your own tactics to suit your own style of play.

**(S★.9) NOTES:** Depending on the scenario, notes may be given to provide the insight of players or the designer.

**HISTORICAL OUTCOME:** The outcome of a historical scenario (SH0.0), usually listing any lost ships or significant events.

**INTEGRATION WITH FUTURE VOLUMES:** BASIC SET is the first element of the *STAR FLEET BATTLES* game system. Other products and modules will add new ships, weapons, rules, races, and scenarios to the game. Should you choose to acquire an expansion module, you will doubtless want to include many of the newly provided ships in scenarios you are familiar with. Information is included in many scenarios of this first volume as a guide to integrating the future volumes into your gaming.

Note that players should feel free to design their own scenarios or to modify the scenarios included here to suit their own tastes.

**(S1.2) SCENARIO TYPES**

The scenario section is one of the exceptions to the alphanumeric rules numbering system. The "S" superscript is used to designate general rules pertaining to all scenarios. The scenarios themselves, however, are divided into four categories, each defined by a different 2-letter superscript and numbered independently. Should a future expansion volume create a new category, a unique two-letter superscript will be assigned to it.

**GENERAL** Scenarios are those that represent a type of battle that occurred frequently during the universe history. These scenarios do not represent a single battle, but many battles happened along the lines shown. The superscript for these scenarios is "SG."

**HISTORICAL** Scenarios represent specific battles that occurred between specific people and ships on a specific date during the universe history. Historical scenarios can be modified into general scenarios by substituting non-historical participants. For example, players might play a historical battle between the Klingons and Federation, but substitute the Kzintis and Romulans to determine how their technology would have functioned in that environment. The superscript for historical scenarios is "SH."

**MONSTER** Scenarios are those in which one of the participants is not a starship, but a creature of some type that lives in space. (Some monsters in other products are huge robot starships, not living beings.) The superscript is "SM" for monster scenarios. Many monster scenarios can be played solitaire (i.e., by one player). Many monsters use rules in (S6.0).

**CAPTAIN'S LOG** includes many scenarios (more than 100 in the first 7 issues). These are designated "SL."

**NEXUS MAGAZINE**, although no longer published (in 1990), included a number of scenarios designated SN. Scenarios from out of print issues of Nexus and Captain's Log may be reformatted and published in new products under the same or different scenario numbers.

**PLAYTEST SCENARIOS** are distributed by various informal means (e.g., in Starletter) and are designated SP. Upon publication, these numbers are changed to the appropriate series above.

**CAMPAIGNS** in section (U0.0) are collections of related scenarios. Mini-campaigns (T0.0) are shorter campaigns, often without time for repairs between scenarios.

**(S1.3) SPECIAL RULES FOR BASIC SET**

Basic Set does not include many advanced and special items which are introduced in Advanced Missions and the various modules. In order to keep the scenarios in Basic Set free of extraneous material, and yet to allow you to use these scenarios when (or if) you add more advanced products to your personal game system, this section provides general information on how to integrate these advanced rules into your existing scenarios.

Generally speaking, section (S1.3) is used with items found in Advanced Missions and Modules J and K. You should ignore this section (S1.3) unless you have one or more of those products. You can, of course, read it to see if you would be interested in adding one of those products.

**(SH.42) SHUTTLES AND PFs:** If you use MRS (multi-role shuttles), fighters (presumably from a carrier) or PFs (a type of small "gunboat" that is the smallest "ship" in the game), the following information will be necessary.

The presence of warp booster packs (J5.0) on any fighters or PFs (to increase their speed) will depend on the year in which the scenario is set. They were introduced for fighters in Y180; PFs always have them, and interceptors have them unless specified otherwise.

**(SH.421)** Multi-role shuttles (J8.0) are available only to certain ships. Players may purchase these shuttles [up to the limits in (J8.5)] under (SH.431).

**(SH.422)** If using EW fighters (R1.F7) from Module J, any carrier with eight or more fighters can replace one standard fighter [per squadron (J4.46)] with an EW fighter. All carrier SSDs show this EW fighter when appropriate. If not using EW fighters, replace the EW fighters with the most common type on that carrier.

**(SH.423)** Players with access to Module K might choose to add PFs to the scenario within those rules.

**(SH.43) COMMANDER'S OPTION ITEMS:** The data given here is the complete version used with Advanced Missions (and other products). A simpler version with only Basic Set technology is shown in the scenarios in this book.

**(SH.431)** Ships can purchase additional or special equipment as Commander's Option Items (e.g., T-bombs, extra marines, MRS shuttles, special drones, etc.) up to 20% of its Combat BPV. See (S3.2) for details and exceptions. Each ship can purchase special drones up to the historical percentages (FD10.6) as part of the Commander's Option Items. Note that (S3.2) allows drone ships extra points for this purpose. Some items may not be available in all time periods and cannot be purchased if the scenario date is before the item's introduction date.

**(SH.432)** The speed of the drones will depend on the year in which the scenario is set. See (FD2.223), (FD10.6), and (FD2.224). The cost of drone speed upgrades is not included in the % limit in (SH.431).

**(S1.4) MAPS**

**(S1.41) INITIAL PLACEMENT:** Units specified as arriving at a map edge at the first of a turn are placed in a hex along that map edge before the Energy Allocation Phase.

**(S1.42) UNIT ARRIVAL:** Units which enter a scenario during a turn (rather than at the start of that turn) must pay for any movement points expended during the portion of the turn before they arrived. The ship is presumed to have traveled at a constant speed during the portion of the turn before it appeared. Changes under (C12.0) are not allowed before entering the map or for the first 8 impulses on the map. For example, a ship moving at speed 16 which arrived (according to the scenario rules) during Impulse #17 would still need energy for 16 hexes of movement, not merely the 8 hexes moved on the map.

**(S1.43) FIXED AND FLOATING MAPS:** Special rule (SH.41) of each scenario will specify if the map is "fixed" or is "floating."

In the case of a floating map, if units are about to move off the edge of the map, simply move every unit 10 hexes (or some other number) away from the edge and allow the battle to continue. You can also place a second map (if you have one) aligned with that edge and continue the battle. If the ships divide into two separate battles

going in opposite directions, simply place them on two separate maps and keep track of how far apart the battles have drifted.

If the map is fixed, it does not float. Whenever a unit leaves the map edge, that unit has left the scenario. In some scenarios, units belonging to one side may be restricted as to which map edges they can leave from. Violating those restrictions causes the ship to be destroyed. If a wild weasel, or wild SWAC, or wild Scout PF moves off the edge of a fixed map, it is voided and the seeking weapons return to their original targets.

**(S1.5) NOTES ON DEPLOYMENT**

**(S1.51) FAST PATROL SHIPS:** PF flotillas will generally be listed as simply "6xPF" rather than the more proper "PFL, PFS, 4xPF" form. In all cases not specifically noted otherwise, a flotilla will include one PFL and one PFS (e.g., the phrase "no leader or scout" would mean to not include the PFL and PFS).

Players who are not using electronic warfare have the option of replacing the PFS with a standard PF.

By mutual consent, players may replace the PFL with a standard PF as a means of simplifying the scenario.

The phrase "or any PF variant" refers to the combat *variants* of the standard type, such as those that replace drones with disruptors or phasers (or vice versa), and does not allow players to select mine warfare, commando, or cargo *versions*. Some scenarios may allow the choice of *versions* and, if this is the case, will be noted. The BPV cost or adjustment is included within the initial cost of the forces in play.

**(S2.0) VICTORY CONDITIONS**

Players may use this system to score some of the scenarios within this game or in determining a balanced force for a game.

**(S2.1) BASIC POINT VALUE**

All ships are assigned a basic point value (BPV), as shown on the MASTER SHIP CHART. While the term "point" has many uses, in this context it often refers to a "BPV point."

BPVs exist as a device to estimate the relative value of different units. It is not an exact science, and some unusual combinations of units that have equal BPVs will not be balanced. Similarly, players must consider that a balanced force with various capabilities is needed for victory; the fact that a particular unit is very expensive does not mean you should spend every point you have available to buy a few of them. Seen another way, if an NFL team spent its entire payroll buying eight superb wide receivers, it wouldn't win any games.

**(S2.11) ITEMS INCLUDED OR NOT INCLUDED:** The BPV of a ship includes its administrative shuttles, but does not (ever!) include mines, fighters, MRS shuttles, SWACS, or PFs. Note that fighters, SWACS, and PFs are purchased as units, not as Commander's Options (S3.2). Other special shuttles (MSS, MLS, HTS, GAS) specified in the ship descriptions are included in the ship's BPV, for example (R6.R3), but additional such shuttles could be substituted for assigned shuttles as part of the Commander's Options (S3.2).

The BPV of all ships (unless otherwise noted) does not include the drone speed upgrade charges; ships are required to pay these charges based on the date of the scenario. Players may use slower drones in special cases (asteroids, webs, bases) where faster drones are not appropriate.

**(S2.12) SPLIT BPVs:** The BPV of some ships is shown as two numbers (A/B). In these cases, the first number is the "Economic BPV," which reflects the cost of building the ship and its relative value. The second number is the "Combat BPV," which reflects its relative combat power.

See (G24.35) in the case of scouts.

The economic BPV of shuttles and fighters is one-half of the combat BPV; see (J1.85). Fighter EPV is not included in the EPV of carriers, or Hybrid ships (including Hydrans).

**(S2.13) TUGS AND PODS:** The BPV of some tug-pod combinations is different than the sum of their elements. See (G14.114).

**(S2.14) GROSS ADJUSTED BPV:** There are various equations, and calculations based on BPV, and it is important to perform them in the correct order. The key point is the "gross adjusted BPV" which is used for various calculations. This GABPV includes:

- the cost of drone speed upgrades (FD2.22)
- the effect of crew quality (G21.0).
- the value of Legendary Officers (G22.0).

but does NOT include:

- Commander's Optional Purchases (S3.2).
- Fighters, PFs, SWACS,

There is a Combat and an Economic version of the GABPV.

**(S2.2) VICTORY CONDITIONS**

**(S2.20) STANDARD VICTORY CONDITIONS:** The use of these values in the basic victory system is as follows:

- A - Before the scenario begins, both players total the "Combat BPV" of their ships. The player with the lower total scores points equal to the difference between the two if none of his units disengage or surrender by the end of Turn #2. In the case of reinforcements, their Combat BPV is not added until they have actually arrived on the map.
- B - In (S3.2), players are given the option of "purchasing" extra weapons or other equipment by paying victory points to the enemy.
- C - After the scenario is over, each player scores points based on the "Economic BPV" of the opposing ships on a ship by ship basis using the percentages shown in (S2.21). Since the economic BPV is used, the effect of any pre-scenario damage on BPV is ignored unless the scenario specifically says otherwise.

**(S2.201)** When using the MODIFIED VICTORY CONDITIONS, ignore step A and use only steps B and C.

**(S2.202)** Many scenarios ignore (S2.2) altogether and define victory in terms of specific actions or accomplishments.

**(S2.21) VICTORY POINTS RECEIVED:** In determining victory for purposes of (S2.20), use the following percentages:

For scoring any internal damage	=	10% of BPV
For forcing a ship to disengage	=	25% of BPV
For crippling an enemy ship	=	50% of BPV
For destroying an enemy ship	=	100% of BPV
For capturing an enemy ship	=	200% of BPV

These percentages are based on the Gross Adjusted BPV. Only one of the above (the greatest) may be scored for each enemy ship (or unit) in play. If using the optional "leaky shields" rule (D3.6), ignore the 10% for "any internal damage."

If a unit self-destructs (D5.0), it is considered to have been destroyed "as a result of enemy action" and the enemy receives victory points as above.

In the case of multi-ship (or multi-side) battles, divide the victory points scored on any given target (including one that self-destructed) proportionally with the amount of internal damage scored on that unit by the various sides or factions.

Any units (fighters, MRS shuttles, extra marines, etc.) on a ship which is destroyed count as destroyed "as a result of enemy action."

If a pod is attached to a tug, it is counted as part of the tug for purposes of victory calculations. If it is dropped, it counts as a separate unit. (e.g., if every box on a pod SSD is marked destroyed but the pod is not dropped, it counts as part of a damaged tug; if dropped, it counts as a destroyed unit.) See (G14.33).

If a ship surrenders, but self-guiding seeking weapons are still targeted on it, the player receiving the surrender is not penalized for the damage the seeking weapons will do, except that the destruction of the surrendered unit by the weapons will limit the victory points received.

In the case of a separated ship section, see (G12.32).

See (G14.33) for tug pods.

**EXAMPLE:** A Federation CC is fighting a Klingon D7 in scenario (SG1.0) THE DUEL. The BPV of the CC is 137; the D7 is 121, so the Klingon player scores 16 points. The Federation player also purchases some additional weapons and equipment (19 points worth), so the Klingon player scores an additional 19 points. In the

course of the scenario, both players scored internal damage on the enemy. The Klingon ship was crippled (S2.4), but the Federation ship disengaged to avoid being hit by several Klingon drones. Thus, the Federation player scored 61 points for crippling the D7 (121 x 50% rounded up); the Klingon player scored 34 points for forcing the Federation ship to disengage (137 x 25% = 34.25 rounded down), plus the 35 points he received for play balance. The score is thus 69 to 61 in favor of the Klingon ship, which thereby won the scenario. Since this score (69/61) is 113%, the Klingon won a marginal victory (S2.3). Note that while the Klingon ship was badly damaged, it did force a more powerful ship to leave the area. Had it been the Klingon ship that disengaged, however, the score would have been 61 (Federation) to 34 (Klingon) = 179%, a Tactical Victory for the Federation (or 56% and a Tactical Defeat for the Klingons).

**(S2.22) ORION PIRATES:** In the case of points scored on (not by) Orion Pirates, these percentages are:

Internal damage	=	10%
Destroyed	=	100%
Forced disengage	=	0%
Captured	=	500%
Crippled	=	50%

Damage from Orion engine doubling does count (against the Orions) for purposes of "scoring internal damage." If repaired during the scenario, engine doubling damage does not count.

**(S2.23) SHUTTLES (including FIGHTERS):** For damage scored on fighters and shuttles the percentages are (retain all fractions in the case of fighters and shuttles):

Damaged	=	25%
Crippled	=	50%
Destroyed	=	100%
Captured	=	100%

Points scored for enemy shuttles which were included in the BPV of the opposing ship are deducted from the BPV of the owning ship when resolving points scored against the ship. For example, a 125-point ship is crippled, but two of its shuttles were destroyed while on the map. The enemy scores two points for killing the shuttles and 50% of 123 for crippling the ship. Damage repaired before the end of the scenario does not count.

**(S2.24) FRACTIONS:** In the case of all of these percentages, round any fractions of 0.500 or more up to the next higher number, those of 0.499 down to the next lower one. Exception: See (S2.23).

**(S2.25) CAMPAIGNS:** Points received for pilot quality (J6.3), PF crew (K1.32), or crew quality (G21.3) are calculated, received, awarded, and evaluated separately from and in addition to victory points. The player might receive victory points to win the scenario, while the crews will receive experience points that improve their abilities in future scenarios.

**(S2.26) EXTRA POINTS** can be scored in various ways, mostly when specified by a scenario. Also: See (J3.222) for a captured WW.

**(S2.27) STALEMATE:** Some situations end in a stalemate. Neither force can (or will) leave, but neither can force the other to leave.

**(S2.271) Case 1:** Special scenario victory conditions may provide a way to resolve a stalemated scenario.

**(S2.272) Case 2:** If one player moves consistently toward the other while the other player consistently moves away (or one ship is consistently cloaked) and no internal damage is scored or manned shuttles are destroyed in 10 turns, the force moving away (or the cloaked ship) is deemed to have disengaged.

**(S2.273) Case 3:** If a base, convoy, FRD, or other "fixed target" is involved, and no internal damage has been scored or manned shuttles destroyed in 10 turns, the attack force must retreat.

**(S2.274) Case 4:** If all units are involved in a general melee, but neither player has scored any internal ship damage or crew casualties, or has destroyed any manned shuttles, within a period of 10 consecutive turns, a stalemate exists. (This includes damage from mines but not terrain.) The scenario is over. Neither player loses (or gains) points for disengagement. Any positive level of victory is reduced by one level.

**(S2.3) LEVELS OF VICTORY**

To determine the level of victory, divide your score by that of your opponent, express the result as a percentage, and consult the following table:

PERCENTAGE	LEVEL OF VICTORY
500%+	ASTOUNDING VICTORY
300%-499%	DECISIVE VICTORY
200%-299%	SUBSTANTIVE VICTORY
150%-199%	TACTICAL VICTORY
110%-149%	MARGINAL VICTORY
91%-109%	DRAW (tie)
67%-90%	MARGINAL DEFEAT
50%-66%	TACTICAL DEFEAT
33%-49%	BRUTAL DEFEAT
20%-32%	CRUSHING DEFEAT
19%-	DEVASTATING DEFEAT

In the example given above, the Klingon player scored a "marginal victory" in the first case and suffered a "tactical defeat" in the second. If any score is less than one point, assume it to be "one point." (Division by zero is a mathematical limbo zone.)

**(S2.4) CRIPPLED SHIPS**

**(S2.41) DEFINING CRIPPLED STATUS:** A ship is crippled when:

- A: 10% or less of its original warp engines undestroyed.
- B: 50% or more of interior boxes destroyed; does not include shields, armor, sensor, scanner, DamCon, or excess damage.
- C: Any excess damage hits.
- D: All of its control spaces destroyed.
- E: All of its weapons destroyed.

Only one of these conditions need be met to consider a ship crippled, not all five. The definition of weapons for condition "E" is given in Annex #7D. Note that this definition of a crippled ship is used for victory conditions (S2.2), emergency life support, and other uses. Also note that this applies to ships (including PFs and bases) only, not to fighters or shuttles.

Repair under rules such as (D9.7) may "uncripple" the ship. Crippling takes effect immediately once the conditions are met.

**(S2.42) EFFECT OF CRIPPLED STATUS:** This is a summary of the restrictions and conditions applied to crippled ships.

1. Can fire probes as weapons (G5.3).
2. Enemy gets points for crippling (S2.2).
3. Can use Emergency Life Support (B3.1 #7).
4. Uses (G2.2) for control (only if all control stations destroyed).
5. Loses nimble status (C11.3) if it was nimble.
6. Less effective in tactical intelligence (D17.21).
7. Loss of -2 HET bonus if not already used (C6.522).

**(S3.0) BALANCING SCENARIOS**

The problem of balancing a scenario (giving both sides a fair chance to win) is compounded by different levels of skill and styles of play among gamers. To compensate for these things, which are beyond the control of the game and scenario designers, players may wish to make modifications to certain scenarios in order to improve their balance. This can be done by modifying the scenario or by equipping the ship with improved weapons.

**(S3.1) MODIFYING SCENARIOS**

No all-encompassing rule is possible in this regard, but certain basic principles can be used as a guide. Most scenarios include suggested means of adjusting balance between players of different skill levels.

The easiest way to modify a scenario is to exchange one of the ships shown in the set-up instructions for a larger one or a smaller one. Another alternative would be to apply several points of random, or carefully selected, damage to one of the ships before the scenario

begins. Other alternatives include limiting a ship's ability to accelerate, limiting its top speed, restricting its maneuvering room by requiring it to remain in a certain area, or placing terrain features that may be more advantageous to one side than the other.

One more subtle approach is to give the stronger player an additional ship, but one that is weak (such as a freighter) or badly damaged in an (assumed) earlier battle. This ship will be more of a liability than an asset.

Another possibility is to "spot" an opponent a number of points, which are added to his score at the end of the scenario.

There are many more ways in which a scenario can be modified. Usually, the fairest way to approach it is for one player to propose a scenario and its modifications, and then for the other to choose which side he wants to play.

Scenarios can, of course, be modified for reasons other than play balance. Perhaps a new ship has appeared in Starletter and you want to test it in an established scenario? Perhaps you want to use a variant suggested in one scenario in a different scenario? Anything mutually agreeable to the players can be used, but be advised that play balance may shift dramatically and that every change from a published scenario will compound the danger of undesirable play-balance implications.

**(S3.2) COMMANDER'S OPTIONS**

**(S3.21) GENERAL:** Players may, under the terms of Section B of the Standard Victory Conditions (S2.20) and the limitations of (S1.3), purchase extra weapons, boarding parties, etc., for their ships. The cost of such items is shown on Annex #6. Some of the items on Annex #6A (e.g., outstanding crew), while they could be purchased as Commander's options in a patrol scenario, are normally purchased as part of the overall force structure of a patrol scenario and are not within the percentage limits given here.

**(S3.211)** Under (S1.3) and in most scenarios, ships are allowed to purchase Commander's Option items up to 20% of the "Effective Adjusted Combat BPV" of the ship (the ship, its refits, and its fighters, but not including the cost of mandatory drone speed upgrades or crew quality adjustments). See (S3.23). If you buy a refit (S3.24) with Commander's Options, this does not increase the EAC-BPV.

**(S3.212)** A wide variety of items are listed on Annex #6. These are subject to various availability restrictions found in the rules. See, for example, (FD10.6) for special drones. You cannot buy "extra" drones unless the ship had some drones to start with.

**(S3.213)** Standard freighters cannot purchase T-bombs.

**(S3.22) DRONE SHIPS:** Ships armed with drones have certain special characteristics.

**(S3.221)** Drone speed upgrade charges are not included within the limit on Commander's Options (they are paid for separately or included in the victory conditions of a fixed scenario). Exception: Faster drones available as limited or restricted weapons in years prior to their general introduction are purchased as Commander's Options.

**(S3.222)** Drone bombardment ships (marked "DB" in the notes column on the Master Ship Chart) might be loaded entirely with type-III-XX drones (FD10.661) if assigned to an independent bombardment mission. In this case, the ship pays the normal costs for its drone racks (with free reloads) and 25% of the total cost of the drones in the cargo boxes. If not on such a mission, a drone bombardment ship is treated as a D% ship (S3.223), i.e., as if it were a carrier with ten or more fighters.

**(S3.223)** Certain ships (marked "D%" in the notes column on the Master Ship Chart) are allowed a higher percentage of special drones under (FD10.6). These ships may expend points up to 30% of the Effective Combat BPV on Commander's Option items, but the extra 10% can only be spent for extra or improved drones.

**(S3.23) CARRIERS:** Carriers add the cost of their fighters to their Effective Combat BPV for purposes of calculating the number of points that can be spent for Commander's Option items, but the extra points received as a result (the % of the fighter BPV) must all be spent for fighter supplies and weapons (e.g., extra drones, chaff pods, booster packs, deck crews, EW pods, etc.).

**(S3.24) REFITS** which are available in the year of the scenario but which are not specified for the ship may be purchased as Commander's Options in a fixed scenario. If a ship never received a



particular refit (as noted in either its unit description or on its SSD) it cannot purchase that refit as a Commander's Option unless the opposing player(s) have agreed to allow this as an experiment.

**(S3.25) SHUTTLES:** Special shuttles (e.g., HTS, MRS, or GAS) may replace administrative shuttles for the cost shown on Annex #6. Fighters cannot be replaced, and special shuttles cannot be "sold back" to gain points for other uses. MRS are limited by (J8.5).

**(S3.26) INDIVIDUAL:** Ships cannot "pool" their BPVs to buy equipment for the entire squadron. Each ship buys its own options as an individual. Equipment can be transferred between ships during the scenario by (G25.0).

**(S3.27) MINES, MINEFIELDS, MINELAYERS:** There are special rules on these items.

**(S3.271)** The number of T-bombs allowed is limited by (M3.13).

**(S3.272)** Only minelayers, ships with mine racks, and certain Romulan ships can have large mines. See (M2.7).

**(S3.273)** Pre-established minefields are purchased as forces, not as Commander's Options. They can only be purchased if specifically allowed by the scenario. The player may be assigned a number of points or (if not) may use points from his force allowance.

**(S3.274)** Only minelayers and minesweepers can have MLS or MSS shuttles.

### (S3.3) MODIFYING SHIPS

Previous editions of *STAR FLEET BATTLES* have included, under this rule heading, various suggestions and restrictions on ways players could modify ships, adding or replacing various weapons or other systems. These rules were often abused, seldom understood, and were never adequately complete to cover every case. As a result, players willing to do anything to win (regardless of how ridiculous that might be) usually did. In the Captain's Edition, player modifications have been deleted. (The original purpose, to allow the creation of special purpose variants, has long been satisfied by the publication of SSDs for those variants.) Consequently, this section has been deleted. A more comprehensive and workable section of modifications rules may be published in a future product; rule number (S7.0) has been reserved for this purpose.

Note that specified refits and variants are not ship modifications in this sense and are legal under the current rules.

### (S3.4) BIDDING

One of the most fascinating approaches involves "bidding." Generally, one player designs a scenario (or uses or modifies a published one) and then invites other players (possibly including himself) to "bid" on taking one side. Exactly what is being bid will be specified in the scenario. For example, one player might suggest a scenario involving a convoy and a pirate ship. The players would then bid on the basis that they will take the pirate if given so many points to buy and equip the pirate's ship. The player who submitted the low bid would then take the pirate and use a number of points equal to his bid to purchase and outfit the pirate ship before the scenario begins. Bidding can also be used by specifying one side of a scenario (and the victory conditions), then holding an auction to determine who will play the other side. The low bidder then buys his entire force [including (S3.2) options] with the points that he bid.

## (S4.0) WEAPONS ARMED STATUS

Life on a starship has been described as "six months of boredom and six minutes of stark, screaming, terror." This rather romantic description is very accurate. Starships may patrol for months or years without ever being called upon to use their weapons. The scenarios that players of the game play or create represent the "few minutes of action" that follow months of patrolling.

Because of this situation, starships simply do not patrol with their weapons "loaded." Besides being expensive in terms of power (and hence fuel) and hard on the maintenance crews (who have enough to do), it is outright dangerous. (Even on a starship, safety is a top priority.) Thus, a ship entering a scenario may not have all (or perhaps any) of its weapons armed.

At all levels of a ship's weapons status, the owning player may elect to have some or all of his weapons armed to a lower status for tactical reasons.

Ships damaged in prior scenarios may not be able to load weapons in higher weapons status conditions. For example, a ship with no warp power might be allowed to have fully loaded photons under WS-III, but would not be able to arm them.

In some cases, for reasons given in the scenario introduction, the ship may have had a warning that action was expected, and this is reflected in the instructions. For example, a ship attacking a base knows exactly where its target is located (the base may have been there for decades) and hence knows exactly when it will go into action. The base, which hasn't seen an enemy ship in years, has no particular reason to know that TODAY is THE DAY that the enemy will attack.

Note particularly that weapons status reflects the condition and operating restrictions of the ship at the *start* of the scenario, and does not directly limit what the ship does during the scenario. For example, at WS-II only one shuttle can be prepared for a special role. This does *not* mean that during a scenario which *started* at WS-II a ship could not have more than one shuttle prepared for a special role at any one time. Similarly, PFs are limited by (K2.43) as to what weapons can be loaded at the start of the scenario, but does not prevent those weapons from being reloaded while docked during the combat scenario.

### (S4.1) ARMING STATUS

For game purposes, a ship is presumed to have its weapons armed to one of the following levels, known as the ship's "WEAPONS STATUS." See (S4.3) for additional conditions. An MRS is treated like a fighter for arming status rules, but cannot be launched before the scenario begins. If loaded as an SP, an MRS would count as one of the "special" shuttles. Also see (G26.22), web anchor. References to carriers includes fully capable carriers (J4.61) and most Hydran ships (J4.623). Fighters on patrol are considered to have fulfilled all launch (J1.34) requirements and are under no fire/launch restrictions. Drone rack loadouts cannot be changed from initial purchases at any weapon status except as specified by special scenario rules.

**(S4.10) WEAPONS STATUS 0:** Ship is not expecting hostile action, but is operating on peacetime conditions.

- Phasers not energized (E2.3), no energy in phaser capacitors (H6.0).
- No torpedoes (or other multi-turn arming weapons) are armed.
- No special shuttles (scatter-pack, wild weasel, or suicide shuttles) may be prepared.
- Drone racks and plasma-F launchers (or plasma-F fighter reload boxes) are loaded.
- No energy may be stored in ESG systems (G23.23).
- Carriers may have two of their fighters armed and ready to launch, but no other fighters may be armed with any reloadable weapons.
- The batteries are fully charged. Exception: (D10.55).

**(S4.11) WEAPONS STATUS I:** The ship is not expecting hostile action, but is in an area where such action has occurred in the recent past. This is the same as Weapons Status 0 except that:

- Phasers are energized; the phaser capacitors are empty.

**(S4.12) WEAPONS STATUS II:** The ship is expecting enemy contact within a short time. The ship can remain in this status for several hours if need be.

- Phasers may be energized and the capacitors fully charged.
- Prior turns arming (but not the last turn) for multi-turn arming weapons may be assumed to have been completed on turns prior to the start of the scenario.
- Energy may be stored in systems designed to hold it for several turns, e.g., ESG capacitors, displacement devices. (Batteries are charged under WS-0.)
- One shuttle may be prepared for a special role (SP, SS, WW).
- Carriers may have completed two turn's activity by their deck crews, and two of their fighters may be launched and placed on the board within two hexes of the carrier as a Combat Space Patrol. If fighters are deployed, the fighters and the ship must have the same facing and the speed of the ship on the "previous turn" cannot exceed the maximum speed of the fighters. Launched fighters can be going faster than the ship.
- Tholians may have formed a pinwheel, and have deployed a zero-strength web around it.

**(S4.13) WEAPONS STATUS III:** The ship is expecting imminent contact or is moving to engage a known enemy force. This is generally the same as Weapons Status II, but with the following additional provisions. The ship can remain at this high level of readiness for only a short time.

- All fighters may be armed. Carriers can deploy four of their fighters within two hexes. If fighters are deployed, the fighters and the ship must have the same facing and the speed of the ship on the "previous turn" cannot exceed the maximum speed of the fighters. Launched fighters can be going faster than the ship. Militia can be formed if the objective is to board and capture a specific unit. Fusion beams are NOT multi-turn arming weapons and cannot begin the game "held" at any weapon status. The "launched" fighters may be placed on the balcony instead, but additional fighters cannot be.
- Formal PF tenders can deploy two of their PFs within two hexes. Casual PFTs (K2.5) cannot do this.
- Two shuttles may be prepared for special roles (SP, SS, WW). One of these (on a PFT) could be a scatter-pack mounted on a PFL docked to that PFT.
- Multi-turn arming weapons may be assumed to be fully armed and are being held in their launch tubes; in this case holding energy must be allocated on the first turn. Note that weapons which cannot be held (e.g., plasma-R torpedoes) cannot be completed prior to this point.
- Up to 10% of the crew may be converted to Militia (D15.83) if the objective of the scenario is to land troops on a planet.
- The unit may be assumed to have fired drones [one per rack (or deployed fighter), fewer if firing restrictions apply] on Impulse #28 of the previous turn. These drones can be placed on the board within four hexes of the launching unit. This provision is ignored with slow-speed drones. Drones placed on the map at start may not be placed within three hexes of an enemy unit. These can be ECM drones, probe drones, or any other type.
- Tholians may have formed a pinwheel, and that pinwheel may have a strength-10 web around it.
- Deception under (D17.71) and (D17.72) may be used.

**(S4.14) NOT ALLOWED AT ANY STATUS:** Some things cannot be done in advance and must await the actual beginning of combat. These include:

- No SWACS or MRS (or cloaked decoy) can be deployed from any ship.
- No scatter-pack, wild weasel, plasma torpedo, or suicide shuttle may be deployed (launched) from any ship.
- The unit cannot be: cloaked (G13.0), using erratic maneuvers (C10.0), using passive fire control (D19.0), moving in reverse (C3.5), or on silent running (D17.75) unless allowed by the scenario.

Note that a ship can only begin a scenario moving in reverse if the scenario set up says that it was doing so. A player may use braking or mid-turn speed changes to move in reverse if he so desires; the ship was moving at its maximum speed on the previous

turn regardless of any energy supposedly diverted to arming weapons or other uses. If the players are creating a scenario, a player must have the permission of his opponent to begin the scenario moving in reverse.

### (S4.2) DETERMINING STATUS

In general (SG0.0) or patrol (S8.0) scenarios, players may roll to determine the weapons status of their ships. (In historical, and some other, scenarios it is specified.) The purpose of this rule is to simulate the above-described fact that a ship would not waste energy keeping weapons warmed up for months or years just in case an enemy happened to show up. This would only happen if the enemy was detected.

Players may simply select a weapons status by mutual agreement. Shrewd players will search for the one that best favors their own forces.

**(S4.21) DIE ROLL:** Each player rolls a single die. One die is rolled for the entire fleet, but it may be modified on a ship by ship basis depending on certain conditions. In this case, one ship of a fleet might have weapons armed while another didn't.

**(S4.22) POSITIVE MODIFIERS:** The die roll is increased by one (these effects are cumulative) if:

- The ship has a legendary captain or navigator.
- The ship has an "outstanding crew."
- This ship has scout functions (G24.0). (This effect counts for the entire fleet.)
- The ship is Orion (they always expect trouble). The Orions do not receive both this modifier and the "wartime" modifier, even if operating as mercenaries. A WYN ship outside of the cluster receives this modifier. A WYN ship does NOT receive both the outside and war modifiers.
- The race is at war, and the unit is in a war zone.

**(S4.23) NEGATIVE MODIFIERS** The die roll is reduced by one (these effects are cumulative) if:

- The ship has a "poor" crew.
- The ship has a sensor rating less than six.

**(S4.24) CUMULATIVE MODIFIERS:** The effects of (S4.22) and (S4.23) will offset each other if both apply. The final result can be no more than +2 and no less than -2.

**(S4.25) FINAL DIE ROLL:** The final, adjusted, die result determines the weapons armed status as per the chart below:

DIE ROLL	WEAPONS STATUS
less than 3	0
3-4	I
5-6	II
7+	III

### (S4.3) RESTRICTIONS AND CONDITIONS

**(S4.31) BALANCE:** This "armed" condition can be used to balance the scenario.

**(S4.32) OVERLOAD:** Prior turns arming allowed by Weapons Status II or Weapons Status III cannot include overload energy.

Exception: Ships armed with photon torpedoes have two points of free overload energy per tube from prior turns when at WS-III. This energy may be allocated between the various photon tubes at the option of the owning player, but all must be used for overloads; none can be used for arming.

**NOTE:** This rule is often restricted to the Federation in tournaments. Check local tournament rules.

**(S4.33) SPECIAL CASES:** Several special cases are defined in the specific rules for those systems.

- See (D18.0) for surprise.
- See (E12.32) for web casters.
- See (FP10.25) for plasma racks.
- See (G10.8) for webs.
- See (G23.23) for rules concerning ESGs.
- See (K2.37) for PFs and (K1.82) for Fi-Con PFs.
- See (P7.4) and (R12.1C) when entering the WYN cluster.
- See (G5.21) for probes.

**(S4.34) SCENARIO RULES:** The rules of a given scenario may modify or override the weapons status rules.

**(S5.0) LOCAL CONDITIONS (Optional)**

In order to introduce some variation to the scenarios of a campaign game (or regular gaming), players may choose to use the chart below to determine the "Local Conditions" in the area of their scenario. This will produce a random "terrain" feature that will prevent the scenarios from all being more or less the same.

**(S5.1) LOCAL CONDITIONS CHART**

At the start of each scenario, roll two dice (either player can do the honors, or each player can roll one) and use the total to determine the local condition from the chart below.

- 2 — BLACK HOLE
- 3 — NEBULA
- 4 — PLANET AND MOON
- 5 — WANDERING MONSTER
- 6 — ASTEROID BELT
- 7 — EMPTY SPACE
- 8 — OLD MINEFIELD
- 9 — PIRATE
- 10 — GAS GIANT
- 11 — VARIABLE PULSAR
- 12 — ROLL AGAIN, TWICE

**(S5.2) EXPLANATION OF RESULTS**

Each result from the chart creates certain special conditions, which are described as follows:

- 2-BLACK HOLE:** A Black Hole (P4.0) is located in hex 2215. You may use the map from Module B.
- 3-NEBULA:** The scenario takes place inside a Nebula (P6.0).
- 4-PLANET AND MOON:** A class-M planet (P2.21) is in hex 2420. A moon (P2.23) is in hex 1514.
- 5-WANDERING MONSTER:** A monster is in hex 2220. Roll one die to determine which monster is present:
  - 1-Planet Crusher.....(SM1.0)
  - 2-Space Amoeba.....(SM2.0)
  - 3-Moray Eel.....(SM3.0)
  - 4-Cosmic Cloud.....(SM4.0)
  - 5-Sun Snake.....(SM5.0)\*
  - 6-Mind Monster.....(SM6.0)\*

\*These are in Advanced Missions. Players who do not have that volume should use (SM3.0) instead. Players may wish to use the two monster tables from (U2.11).

The scenario is then resolved with the monster unfriendly to both players. Scenario (SG9.0) can be used to resolve it by a different means.
- 6-ASTEROID BELT:** Set up an asteroid belt (P3.1), or use the Asteroid Belt or Asteroid Field map from Module B.
- 7-EMPTY SPACE:** No local conditions, simply an empty map. When not using the local conditions rule, most scenarios are of this type.

**8-OLD MINEFIELD:** Set up an asteroid belt (P3.1), but in this case the asteroid counters do not represent asteroids but nuclear space mines (M2.0) of an old minefield. The minefield is neutral. Each mine hex includes one large mine set to trigger on ships of size 4 or larger and one small mine set to trigger on units size 5 or smaller. You could also use the asteroid field map from Module B.

**9-PIRATE:** A pirate CR is in hex 2215, unmoving, Weapons Status III, all extra energy in general shield reinforcement. Optional weapons are drone racks in the wings and disruptors in the center. At the start of each turn, before the Energy Allocation Phase, both players roll one die. Each keeps a running total of his die rolls. When the total die rolls of one player exceed those of the other by 10 (or by some other number if mutually agreed), the pirate ship automatically and immediately joins (comes under the control of) that player.

Alternatively, if the pirate is fired on by either player, the other player immediately and automatically assumes control of the pirate and the die roll procedure is dropped. In any event, the pirate ship will disengage automatically (C7.4) at the end of any turn in which it is crippled. It should be noted that attacking the pirate is a worthwhile option, since crippling it (with a surprise blow) would score 43 points. If both shoot at the pirate simultaneously, it disengages automatically (C7.4). The following are NOT considered to constitute "attacking" the pirate: wild weasel collateral damage. The following ARE considered to constitute "attacking" the pirate: dropping a mine or T-bomb in his hex or in an adjacent hex.

If this condition appears in scenarios involving pirates, assume the pirate to be of a different cartel.

**10-GAS GIANT:** A Gas Giant (P2.22) is located in hex 1815. Roll one die to determine the radius; consider a die roll of "1" or "2" to be "3". (If the die roll is 3, the planet would extend from 1515 to 2115 and from 1812 to 1818.) The outer ring (example, hex 1812 above) is atmosphere (P2.6). Rings two hexes wide surround the planet; there is a one hex gap between the planet and rings. (In the above example, hex 1811 would be clear, hexes 1810 and 1809 would be ring hexes.) You can also use the Saturn map from Module B. (Most gas giants have several moons of various sizes; you may add these if you wish. Allow each player to roll a die and place that number of moons anywhere within 20 hexes of the planetary surface.)

**11-VARIABLE PULSAR:** A Variable Pulsar (P5.0) is in hex 2215.

**12-ROLL AGAIN, TWICE:** This creates two overlapping conditions. Roll again, twice, and use both results except that:

- \* another "12" is ignored.
- \* In the event of a Black Hole, ignore the other result.
- \* If both #4 and #10 are rolled, ignore #4.
- \* If both #6 and either #4 or #10 are rolled, ignore #6.
- \* In the event of a Variable Pulsar, ignore the other result unless it is a Black Hole.

**(S5.3) RESTRICTIONS AND CONDITIONS**

Certain conditions and restrictions are applied to this system.

**(S5.31) EXISTING TERRAIN:** If terrain is specified in the scenario, do not use the local conditions system.

**(S5.32) BASE:** If a base is specified for the scenario, ignore conditions 2, 3, 5, 8, 9, and 11. If the base is within three hexes of a planet (or ring), the owner of the base must move it to any hex (of his choice) that is four hexes from the planet.

**(S5.33) SHIP SET UP:** Ships specified to set up in specific hexes may be moved (by the owning player) up to six hexes in any direction to avoid conflict with one of the local conditions.

**(S5.4) ADVANCED LOCAL CONDITIONS**

The charts below can be used in place of (S5.1). They incorporate new material from Advanced Missions and other products. Roll one die on the Event Chart to determine which of the secondary charts to use.

**(S5.41) RANDOM EVENT CHART**

1. THIRD PARTY: See Chart A
2. TERRAIN: See Chart B
3. DANGEROUS ZONE: See Chart C
4. MONSTER: Use either chart from (U2.11)
5. ROLL AGAIN, TWICE (same rules as before, but 2nd Black Hole result indicates one Black Hole with gravity waves.)
6. EMPTY SPACE: No terrain; standard map.

**(S5.42) CHART A: THIRD PARTY INTERVENTION**

1. PIRATE: See #9 on original chart. Optional weapons are drone racks in the wings and disruptors in the hull.
2. ANDROMEDAN: Requires third player; if not available use Pirate. Third player operates Andromedan as per (SG10.4).
3. FREIGHTER: Large (neutral) freighter in 2215 facing B, speed 4; will not turn, slow down (unless damaged to the extent it cannot maintain speed), or fire. Shields maximum with all extra power in general reinforcement. One hundred points awarded for capturing the freighter; no points for destruction, crippling, etc.
4. OLD MINEFIELD: See #8 on original chart.
5. DERELICT: Wrecked cruiser in 2215. Toss a coin to determine the original owner (from among the players in the scenario). The ship is a CL or CW of the designated race. There is no crew on board. It is at speed zero, WS-0, no damage repaired. Apply 75 points of damage as a single volley to the unreinforced #1 shield by the DAC. Neither player receives any points for destroying or damaging the ship, but either player receives 200 points for capturing it.
6. EMPTY SPACE

**(S5.43) CHART B: TERRAIN**

1. BLACK HOLE: See #2 on original chart.
2. PLANET AND MOON: See #4 on original chart.
3. ASTEROID BELT: Set up an asteroid belt (P3.1).
4. GAS GIANT: See #10 on original chart.
5. VARIABLE PULSAR: In hex 1720, (P5.0).
6. EMPTY SPACE

**(S5.44) CHART C: DANGEROUS ZONES**

The scenario takes place in a dangerous zone. The border (last effective hex) of the zone is 100 hexes from 2215 in any direction.

1. NEBULA (P6.0)
2. HEAT ZONE (P10.0)
3. RADIATION ZONE (P15.0)
4. ION STORM (P14.0)
5. DUST CLOUD (P13.0)
6. EMPTY SPACE

**(S6.0) DEFEATING MONSTERS**

Monster scenarios (SM) often use the chart below to determine victory over the creature.

**(S6.1) MONSTER DEFEAT TABLE**

Monster scenarios often use the table below to determine victory over the creature. In many scenarios involving monsters, the investigating ships are required to obtain a required number of scientific information points about the monster in order to roll on the table below. These points can be gained by the use of labs (G4.1), probes (G5.2), probe drones (FD6.0), shuttles (J2.212) not including fighters (J4.41) but including some other types described in the rules, MRS shuttles (J8.31), SWAC shuttles (J9.33), and scout channels (G24.27).

Note that Tactical Intelligence (D17.0) may be used to gain information about monsters which are typed as ships (none of which are in Basic Set), such as those in table (S6.2) below, but this information is of a different kind and doesn't work with table (S6.1).

DIE ROLL	HOW TO DESTROY THE MONSTER
1	Monster can be destroyed by a suicide shuttlecraft (J2.22).
2	Monster will be destroyed if held in a tractor beam.
3	Monster can be destroyed by 200 points of damage from any weapons.
4	Monster can be destroyed by a probe (G5.3).
5	Insufficient data. Accumulate 100 more points of information and roll again.
6	Communication established with Monster. It becomes friendly and you are not required to destroy it. If you have scored more than 50 points of damage on it, you lose the scenario.

**(S6.2) MONSTER DATA TABLE**

See Annex #12. This data is in an annex so that it can be updated as new monsters are encountered and brought to you in future products.

**(S6.3) INCOMPLETE ENGAGEMENTS**

In the event of a second scenario against the same individual monster, any damage to the monster scored in the first scenario would be repaired, but any information gained would still be known. The ship would, however, have to gain an additional 50 points of information to determine that this was the same monster and that no other conditions had changed. These 50 points are then lost, but the points gained in the previous scenario(s) are restored at that point. Accumulation of additional points then begins. If less than 50 points were gained in the first scenario, they are lost and the 50 points to re-identify are not required.

**(S6.4) REPEAT ENGAGEMENTS**

In the event of a scenario against a monster of the same type as one previously defeated (but not the same individual), the ship must gain 50 points of information to establish that it is the same type of monster. After that, the method of defeating the monster established in the previous encounter is confirmed as still usable on a die roll of 1-5. On a die roll of 6, the previous information is determined to be invalid in this case, and the ship must treat the monster as a new case (with the 50 points gained counting toward the determination required).

**(S7.0) SHIP MODIFICATIONS**

This rule number has been reserved for a comprehensive rule on modifying ships. It is not known at this time when this rule will be presented.

**(S8.0) PATROL SCENARIOS**

This rule (in Advanced Missions) is a comprehensive rule on "Patrol" scenarios where players, within various limits, buy their fleets within a specified budget.

**END OF SECTION (S0.0) BASIC SET**

## (SG0.0) GENERAL SCENARIOS

The scenarios in this section can be adapted to almost any race at almost any time period. They represent typical situations which occurred countless times during the historical period covered by the game. In all General Scenarios, the players should **FIRST** decide what year the scenario will be set in. This will define many factors such as drone speed, refits, etc.

Within the (SG0.0) scenarios, various silhouettes are used as an indication of how many ships are involved in the battle. Ships from any race can be used.

### (SG1.0) THE DUEL THE INTRODUCTORY SCENARIO



by Stephen V. Cole, Texas

This scenario depicts typical cruiser actions in deep space. For whatever reason, two hostile cruisers have come into contact, and all attempts to peacefully resolve the situation (whatever it is) have failed.

**(SG1.1) NUMBER OF PLAYERS:** 2; the Federation player and the Klingon player.

#### (SG1.2) INITIAL SET UP

**FEDERATION:** CA in 4203, heading E, speed 15, WS-II.

**KLINGON:** D7 in 0730, heading A, speed 15, WS-II.

(Note that any two ships of relatively equal size can be substituted for those shown, from bordering races, non-bordering races, or even the same race.)

**YEAR:** Players should select a year before set up. This year will define available ships, weapons, and refits. Y168 is assumed if no other decision is made.

**(SG1.3) LENGTH OF SCENARIO:** The scenario continues until all forces belonging to one side have been destroyed, captured, or have disengaged.

#### (SG1.4) SPECIAL RULES

**(SG1.41) MAP:** Use a floating map. The Federation ship can only disengage from the 42xx or the xx01 map edges. The Klingon ship can only disengage from the 01xx or xx30 map edges. Units which disengage in unauthorized directions are considered destroyed.

**(SG1.42) SHUTTLES AND PFs:** There are no PFs, fighters, or multi-role shuttles in this scenario, and this rule can be ignored. If playing this scenario using rules and components from other products (or the Kzinti CV), the player might choose to use these items within their standard rules. See (S1.3).

#### (SG1.43) COMMANDER'S OPTION ITEMS

**(SG1.431)** Each ship can purchase additional or special equipment as Commander's Option Items (e.g., T-bombs, extra marines, etc.) up to 20% of its Combat BPV. See (S3.2) for details and exceptions. Note that whatever is spent here counts in the Standard Victory Conditions (S2.2) as victory points for the enemy.

**(SG1.432)** All drone speeds and types are available subject to agreement by the players on their use. Drone speed costs will increase the BPV of some ships. If you have Advanced Missions, see (S1.3) regarding the purchase of special drones.

**(SG1.44) REFITS:** All refits are available depending on the players' mutual agreement on their use.

#### (SG1.5) VICTORY CONDITIONS

Enemy ship captured: **DECISIVE VICTORY**, Captain will become Admiral in 1 to 3 years; First Officer will be made Captain at end of cruise; crewmen share in prize money†; significant gain in knowledge of enemy technology.

Enemy ship destroyed: **SUBSTANTIAL VICTORY**, same as above, but no prize money or gain in technology.

Enemy ship crippled: **TACTICAL VICTORY**, decoration for valor in action and a reputation for being a "tough fighter."

Enemy ship disengages: **MARGINAL VICTORY**, Commendation from Fleet Command, veiled comments about your inability to win a decisive victory.

If your ship was crippled, then the victory is reduced by one level.

If a ship disengages without being crippled, the captain receives a commendation (based on his report of how much MORE damage he scored on the enemy ship before "enemy reinforcements" arrived). If a ship disengages after being crippled, the captain will face a review board but will probably be exonerated (although if this happens too often, he will probably be promoted to a desk job or forced to take "early retirement"). Thus, a captain who disengages will actually receive the same reward as the captain who did not. Of course, both captains will know who actually played better.

† Prize money is a cash bounty paid for capturing an enemy ship. Some fleets, such as the Federation, do not do this; they apparently find decorations and awards to be a cheaper way of rewarding successful crews.

**(SG1.6) VARIATIONS:** The scenario can be played again under different conditions by making one or more of the following changes:

**(SG1.61)** Select two cruisers from any other two races, or perhaps the same race fighting a civil war.

**(SG1.62)** Each player selects a ship with multiple variants; use the Tactical Intelligence rules (in Advanced Missions) to avoid being surprised.

**(SG1.63)** Play the scenario using frigates, destroyers, or light cruisers. Klingon frigate captains are always trying to distinguish themselves. Where do you think Klingon battlecruiser captains come from?

**(SG1.64)** Play the scenario using two small ships against one larger one. Additional ships should be placed within three hexes of the first ship's (of that side) location.

**(SG1.65)** Play the scenario using two or more ships on each side. Additional ships should be placed within three hexes of the first ship's (of that side) location.

**(SG1.66)** Advanced Missions and various other modules include many additional ships that could be used in duels.

**(SG1.67) BALANCE:** The scenario can be balanced between players of different skill levels by one or more of the following:

**(SG1.71)** Allow one side to use fast (or faster) drones.

**(SG1.72)** Replace one side's cruiser with a smaller ship (or a larger one?).

**(SG1.73)** Give one side its refit(s) but not the other side.

**(SG1.74)** Reduce the starting speed of one ship, which limits how fast it can accelerate on the first turn.

**(SG1.75)** Give one ship a higher weapons status.

**(SG1.8) TACTICS:** Each race has its own tactics. You should try to capitalize the strengths of your ship and the weaknesses of your enemy's ship.

**(SG1.9) DESIGNER'S NOTES:** In a historical context, destruction or capture of an enemy ship would be extremely rare. In an actual battle, the first ship to take serious damage would disengage. Advanced Missions will include many new ships which could be used in a duel situation.

**(SG2.0) FLEET ACTION**

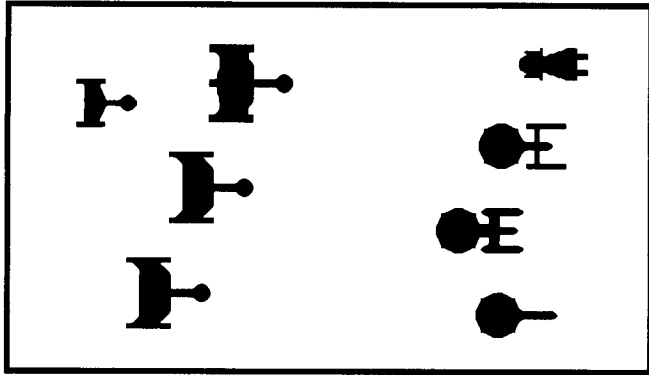

by Stephen V. Cole, Texas

Fleet actions are rare events (outside of wars) in the history of this section of the Galaxy. Most combat has been between individual ships. However, on occasion some particular incident or situation (a contested planet, a pirated freighter, a raid by a lone cruiser that must be avenged, etc.) sets the stage for a meeting of the fleets.

**(SG2.1) NUMBER OF PLAYERS:** There are two sides in this battle. Any number of players may participate as two teams. The ships of each side may all be operated by a single player, one player may operate each one, or each player may operate two or three ships.

**(SG2.2) INITIAL SET UP**

**FORCE "A":** (See SG2.6) Setup in any hex or hexes with digits of "01xx" through "04xx" inclusive, heading of each ship at the option of the owning player, speed 10, WS-II.

**FORCE "B":** (See SG2.6) Setup in any hex or hexes with digits of "39xx" through "42xx" inclusive, heading of each ship at the option of the owning player, speed 10, WS-II.

**YEAR:** Players should select a year before set up. This year will define available ships, weapons, and refits. Y168 is assumed if no other decision is made.

**(SG2.3) LENGTH OF SCENARIO:** The scenario continues until all forces belonging to one side have been destroyed, captured, or have disengaged.

**(SG2.4) SPECIAL RULES**

**(SG2.41) MAP:** Use a floating map. The Force B ships can only disengage from the 42xx or the xx01 map edges. The Force A ships can only disengage from the 01xx or xx30 map edges. Units which disengage in unauthorized directions are considered destroyed.

**(SG2.42) SHUTTLES AND PFs:** There are no PFs, fighters, or multi-role shuttles in this scenario, and this rule can be ignored. If playing this scenario using rules and components from other products (or the Kzinti CV), the player might choose to use these items. See (S1.3).

**(SG2.43) COMMANDER'S OPTION ITEMS**

**(SG2.431)** Each ship can purchase additional or special equipment as Commander's Option Items (e.g., T-bombs, extra marines, etc.) up to 20% of its Combat BPV. See (S3.2) for details and exceptions. Note that whatever is spent here counts in the Standard Victory Conditions (S2.2) as victory points for the enemy.

**(SG2.432)** All drone speeds and types are available subject to agreement by the players on their use. Drone speed costs will increase the BPV of some ships. If you have Advanced Missions, see (S1.3) regarding the purchase of special drones.

**(SG2.44) REFITS:** Players are free to determine the refit status of the ships so long as both agree.

**(SG2.5) VICTORY CONDITIONS:** Use the Standard Victory Conditions (S2.2).

**(SG2.6) ORDER OF BATTLE VARIATIONS:**

**(SG2.61)** Any of the following forces may be used as Force "A" or Force "B":

RACE	POSSIBLE FORCES
FEDERATION	1xDN, 1xCA, 2xCL -or- 1xCC, 2xCA -or- 1xCC, 1xCA, 2xCL -or- 1xBT + 2xCL -or- 1xBT, 3xDD -or- 1xDN, 1xCA, 1xDD, 1xSC -or- 1xCC, 1xCA, 3xDD
KLINGON	1xD7, 3xD6 -or- 3xD7 -or- 1xC8/9, 1xD7, 1xD6, 1xF5 -or- 1xC8/9, 2xD6, 2xF5 -or- 2xD6, 2xF5, 2xE4
KZINTI	1xCS, 3xCL -or- 2xCS, 2xCL -or- 1xCV, 2xCL, 1xFF -or- 1xCV, 1xCS, 1xCL, 2xFF
ROMULAN	4xWB+ -or- 3xWE -or- 3xKR -or- 1xKR, 2xWE, 2xWB+ -or- 2xKR, 2xK5R -or- 2xWE, 2xK5R
GORN	2xCA, 2xCL -or- 3xCA -or- 2xCA, 3xDD -or- 2xCA, 1xCL, 2xDD

**(SG2.62)** Players may, and should, feel free to experiment by using different combinations of ships. Alternatively, some substitutions could be allowed. In a battle between the Federation and Romulans, for example, a Gorn CA could be substituted for a Federation CA.

**(SG2.63)** Players with Advanced Missions may wish to substitute similar ships and use Tactical Intelligence (D17.0).

**(SG2.7) BALANCE:** The scenario can be balanced between players of different skill levels by one or more of the following:

**(SG2.71)** Change one of the smaller ships with a larger one.

**(SG2.72)** Eliminate a small ship.

**(SG2.73)** Give one side its refit(s) but not the other side.

**(SG2.74)** Reduce the starting speed of one ship, which limits how fast it can accelerate on the first turn.

**(SG2.75)** Give one ship a higher weapons status.

**(SG2.8) TACTICS:** In fleet battles, every race has its own tactics. Generally, you attempt, each turn, to destroy or disable the largest enemy ship possible. Keep your fleet together to concentrate firepower; if you spread ships out (as wargamers tend to do in ground combat games), he can destroy one while remaining out of the effective range of the others. Try to concentrate your fire on a single enemy shield while spreading his fire over several of your own.

**(SG2.9) DESIGNER'S NOTES:** Players in possession of Advanced Missions will note that many more ships (and several more races) are available, creating an almost limitless number of combinations. By the time the average player has mastered Basic Set and proceeded to Advanced Missions, he will be well able to build fleets by point values and will have no need of proposed fleet lists.

**(SG3.0) BASE DEFENSE**

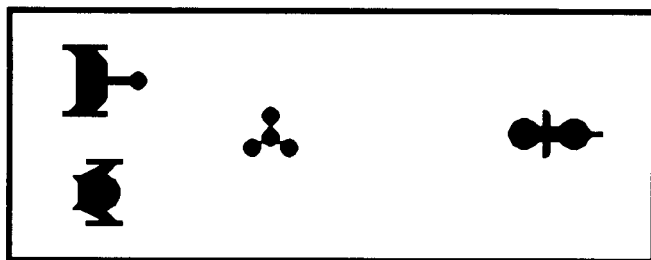

by Stephen V. Cole, Texas

Along the frontiers of all the races in the game are outpost stations. These provide early warning of intrusion, in addition to being bases for patrols. In the event of war, the first action of an invading enemy fleet must be to destroy the bases opposing it. Even during times of relative peace, an enemy force might cross a border to destroy a base. This could be done simply as a "war of attrition" or to create an opportunity for smuggling or infiltration.

**(SG3.1) NUMBER OF PLAYERS:** 2; the defending player who operates the base and the ships that arrive to rescue it, and the attacking player who operates the ships attacking the base.

For a three player option, give the third player the ship that arrives to rescue the base. This could be from a third race, probably one allied to the race that owns the base.

**(SG3.2) INITIAL SET UP**

**DEFENDER:** Base station in 2215, WS-I.

One or more "friendly" ships (maximum BPV of 135) enter on a later turn in any hex starting with 01, heading at player's option, speed max, WS-III, arrive as per (SG3.45).

**ATTACKER:** Up to three ships (maximum BPV of 225) enter the map turn one in any hex starting with 42, heading at the player's option, speed 10, WS-II.

**NOTE:** For beginning players, possible forces are listed in (SG3.63) below. After gaining experience, players can select ships of their own choosing within the BPV limits given.

**YEAR:** Players should select a year before set up. This year will define available ships, weapons, and refits. Y168 is assumed if no other decision is made.

**(SG3.3) LENGTH OF SCENARIO:** The scenario continues until all forces belonging to one side have been destroyed, captured, or have disengaged.

**(SG3.4) SPECIAL RULES**

**(SG3.41) MAP:** The map is fixed; it does not float. Any unit leaving the map has disengaged and cannot return. The Attacking ships can only disengage from the 42xx map edge. The Defending ship can disengage from any map edges except the 42xx map edge. Units which disengage in unauthorized directions are considered destroyed.

**(SG3.42) SHUTTLES AND PFs:** There are no PFs, fighters, or multi-role shuttles in this scenario, and this rule can be ignored. If playing this scenario using rules and components from other products (or the Kzinti CV), the player might choose to use these items. See (S1.3).

**(SG3.43) COMMANDER'S OPTION ITEMS**

**(SG3.431)** Each ship can purchase additional or special equipment as Commander's Option Items (e.g., T-bombs, extra marines, etc.) up to 20% of its Combat BPV. See (S3.2) for details and exceptions. Both players should spend the same number of points.

**(SG3.432)** Drone speeds will depend on the year selected for the scenario. Drone speed costs will increase the BPV of some ships. If you have Advanced Missions, see (S1.3) regarding the purchase of special drones.

**(SG3.44) REFITS:** The refit status of the ships will depend on the year selected for the scenario.

**(SG3.45) REINFORCEMENTS:** Before the first Energy Allocation Phase, the attacking player places Kzinti drone counters number one to four into a cup. The defending player draws one, examines it, and places it face down beside the board, putting the other three drones

aside where they cannot be examined by the attacking player. The number on the drone drawn will show the turn of arrival of the defending ship. It is kept secret until the turn of arrival, then shown to the attacking player.

**(SG3.5) VICTORY CONDITIONS:** For the defending player:

- Each attacking ship captured: .....7 points
- Each attacking ship destroyed: .....5 points
- Each attacking ship crippled: .....3 points
- Each attacking ship disengaged: .....0 points
- If the defending ship is crippled\*: .....-2 points
- If the defending ship is destroyed\*: .....-4 points
- If the defending ship is captured\*: .....-8 points
- If the base is crippled: .....-6 points
- If the base is destroyed: .....-12 points
- If the base is captured: .....-18 points

Victory is determined simply by the point total. A positive score indicates a "defending" player victory, while a negative score indicates an "attacker" victory. Note that an attacking ship that disengages crippled counts as a crippled ship. A captured crippled ship or base would count as a captured ship or base. A destroyed ship or base is a destroyed ship or base whether or not it was captured or crippled before hand.

\*If there are two small defending ships instead of one large one, score half this number of points for each.

**(SG3.6) VARIATIONS:** The scenario can be played again under different conditions by making one or more of following changes:

**(SG3.61)** Change the base station to a battle station and give the attacker 100 additional BPV and the defender 50 additional BPV.

**(SG3.62)** Use the ships from Advanced Missions to create your own attack and defense forces.

**(SG3.63)** The table below provides the players with a selection of forces for both the defending and the attacking players.

RACE	DEFENDER	ATTACKING PLAYER
Federation	1xCA	1xCA + 1xCL -or- 1xCC + 1xDD
Klingon	1xD6	1xD7 + 1xD6 -or- 1xD6 + 2xF5
Romulan	1xWE or KR	3xWB -or- 1xKR + 1xWE
Kzinti	1xCS	1xCS + 1xCL -or- 1xCV* + 1xFF
Gorn	1xCA	1xCA, 1xCL
Orion	----	3xCR
Tholian	2xPC	----

\*The CV does have its fighters. These forces can be altered to produce a balance of forces suitable to the players.

**(SG3.64)** Add modules, fighters, and minefields to the base and increase the BPV of the attacking force appropriately.

**(SG3.7) BALANCE:** The scenario can be balanced between players of different skill levels by one or more of the following:

**(SG3.71)** Reduce the attacker's BPV by up to 40 Points.

**(SG3.72)** Delete the "1" drone and add the "5" drone to the cup before the defender draws.

**(SG3.73)** Give one side its refit(s) but not the other side.

**(SG3.74)** Reduce the starting speed of the attackers, which limits how fast they can reach the base on the first turn.

**(SG3.75)** Give one side a higher weapons status.

**(SG3.8) TACTICS:** The attacker must move in and hit the base with a massive strike as soon as possible. Hopefully, the base will be destroyed before the defending ship arrives.

**(SG3.9) DESIGNER'S NOTES:** In Advanced Missions players will find rules on minefields, which would make the scenario more interesting but require a more powerful attacking force. Rules to operate fighters are found in (R1.4), but most fighters are in Module J.

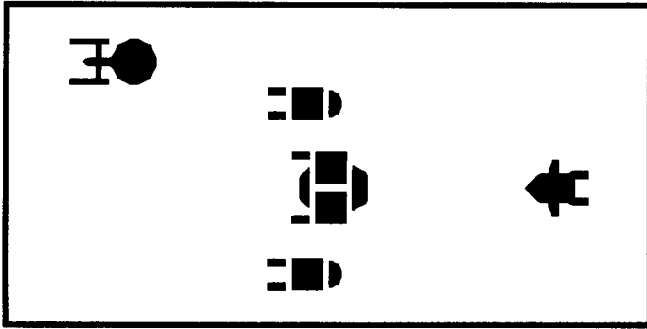
**(SG4.0) BASIC PIRACY**

by Stephen V. Cole, Texas

In this scenario, one player will be operating a convoy and the other a single Orion Pirate Raider. The convoy player will select his forces from the list below.

**(SG4.1) NUMBER OF PLAYERS:** 2; the convoy player, who may be of any race except Orion, and the Orion player.

**(SG4.2) INITIAL SET UP**

**CONVOY:** Three to six freighters, one each in 2316, 2117, 1918, 2519, 2320, 2121. One escort (if desired) within three hexes of any freighter. All heading in direction B, speed 6, WS-0.

**PIRATE:** CR enters from any map edge, heading and speed at player's option, WS-III.

**YEAR:** Players should select a year before set up. This year will define available ships, weapons, and refits. Y168 is assumed if no other decision is made.

**(SG4.3) LENGTH OF SCENARIO:** The scenario continues until all forces belonging to one side have been destroyed, captured, or have disengaged.

**(SG4.4) SPECIAL RULES**

**(SG4.41) MAP:** Use a floating map. Any unit can disengage in any direction.

**(SG4.42) SHUTTLES AND PFs:** There are no PFs, fighters, or multi-role shuttles in this scenario, and this rule can be ignored. If playing this scenario using rules and components from other products (or the Kzinti CV), the player might choose to use these items. See (S1.3).

**(SG4.43) COMMANDER'S OPTION ITEMS**

**(SG4.431)** The Pirate and escort ships can purchase additional or special equipment as Commander's Option Items (e.g., T-bombs, extra marines, etc.) up to 20% of its Combat BPV. See (S3.2) for details and exceptions. Note that whatever is spent here counts in the Modified Victory Conditions (S2.2) as victory points for the enemy.

**(SG4.432)** Depending on the year selected, all drone speeds are available. Drone speed costs will increase the BPV of some ships. If you have Advanced Missions, see (S1.3) regarding the purchase of special drones.

**(SG4.44) REFITS:** Refits may be applied depending on the year selected by the players.

**(SG4.45) CONVOY COHESION:** All ships of the convoy must remain together. Every ship must be within 10 hexes of every other ship of the convoy (not counting ships captured by the Orion).

**(SG4.46) REINFORCEMENTS:** On Turn #6 begin rolling a die once each turn, before the Energy Allocation Phase. When a "1" is rolled, discontinue rolling. This indicates that the SOS messages have been received and the relief force has arrived (on that turn). This relief force, which is friendly to and operated by the convoy player, consists of one cruiser (or two frigates or destroyers) of the same race as the convoy. It arrives in any hex 35 hexes from the nearest convoy ship, heading toward the convoy, speed max, and WS-III. (Roll one die to determine the direction it arrives from).

**(SG4.47) ESCORT:** The convoy player may have an escort. This is the smallest warship or police ship available (non-PF) from his race. He must pay a penalty (see below) of 1/3 of the BPV of this escort.

**(SG4.48) Q-SHIP:** The convoy player may include a Q-ship (R1.7) in his convoy. He must pay a penalty equal to the BPV of the Q-ship if one is included. Note that the special Q-ship rules must be used whether one is in the convoy or not to avoid giving away the fact.

**(SG4.5) VICTORY CONDITIONS:** The convoy player receives 10 victory points for each large freighter and 5 for each small freighter that he had in his convoy. Any penalties for Q-ships or escorts are deducted. After the scenario is completed, add victory points from the Modified Victory Conditions to determine victory.

However, if the Orion ship is captured, the game is automatically won by the convoy player. Note that destruction of the CR is not an automatic victory. Also, the Orion player loses if he does not capture at least one freighter.

**(SG4.6) VARIATIONS:** The scenario can be played again under different conditions by making one or more of the following changes:

**(SG4.61)** If you have Advanced Missions, allow the convoy player to select the make up of his convoy from the available merchant vessels, such as the Free Trader, the Federation Express, the Large Ore Carrier, the Armed Freighter, etc.

**(SG4.62)** If you have Advanced Missions, allow the convoy player to select a few armed freighters of the appropriate race and the Pirate can use the Tactical Intelligence Rules (D17.0) to decide how to attack. The penalty is 1/3 of the difference in BPV between the armed freighter and the standard freighter it replaced.

**(SG4.63)** If you have Advanced Missions, use a smaller convoy and replace the CR with an LR.

**(SG4.64)** Replace the Orion ship with a Q-ship that is already inside the convoy.

**(SG4.7) BALANCE:** The Pirate should win the scenario easily. Once you have the basic tactics down, start attacking tougher convoys (or using smaller Pirate ships). Some suggestions:

**(SG4.71)** Allow the convoy player to use two escorts or one larger escort.

**(SG4.72)** Have the convoy player begin rolling for help before Turn #6 (favors the convoy) or later than Turn #6 (favors the Pirate).

**(SG4.73)** Add or delete freighters from the convoy.

**(SG4.8) TACTICS:** The Orion player has little time to accomplish his goal. Double your engines, roar in at high speed, disable the escort, grab a freighter, and leave!

The convoy must concentrate its firepower on one shield of the Orion ship to cause enough internal damage to slow him down. Deploy your shuttles for extra firepower. Stay at low speed. Use power for negative tractor to make him work for his bounty. Have one of the larger freighters tractor him to slow him down. He'll win the auction at the first of the next turn, but he will lose a turn and the cavalry is on the way!

**(SG4.9) NOTES:** Advanced Missions includes several additional Pirate ships, escorts, and freighters. These could be added to the scenario.



**(SG5.0) DUEL WITH A PIRATE RAIDER**

by Stephen V. Cole, Texas

This scenario uses the basic concepts of (SG1.0) but is specifically geared to combat with an Orion Raider.

**(SG5.1) NUMBER OF PLAYERS:** 2; the “police” player and the Pirate player.

**(SG5.2) INITIAL SET UP**

**POLICE:** Ship(s) as per (SG5.6); set up in 0730, heading A, speed 15, WS-II.

**PIRATE:** CR in 4203, heading E, speed 15, WS-II.

**YEAR:** Players should select a year before set up. This year will define available ships, weapons, and refits. Y168 is assumed if no other decision is made.

**(SG5.3) LENGTH OF SCENARIO:** The scenario continues until all forces belonging to one side have been destroyed, captured, or have disengaged.

**(SG5.4) SPECIAL RULES**

**(SG5.41) MAP:** Use a floating map. Any unit can disengage in any direction.

**(SG5.42) SHUTTLES AND PFs:** There are no PFs, fighters, or multi-role shuttles in this scenario, and this rule can be ignored. If playing this scenario using rules and components from other products (or the Kzinti CV), the player might choose to use these items. See (S1.3).

**(SG5.43) COMMANDER'S OPTION ITEMS**

**(SG5.431)** Each ship can purchase additional or special equipment as Commander's Option Items (e.g., T-bombs, extra marines, etc.) up to 20% of its Combat BPV. See (S3.2) for details and exceptions. Note that whatever is spent here counts in the Modified Victory Conditions (S2.2) as victory points for the enemy.

**(SG5.432)** All drone speeds and types are available subject to agreement by the players on their use. Drone speed costs will increase the BPV of some ships. If you have Advanced Missions, see (S1.3) regarding the purchase of special drones.

**(SG5.44) REFITS:** All refits are available dependent on the players agreement to use them and the year selected.

**(SG5.5) VICTORY CONDITIONS:** Use the Modified Victory Conditions (S2.2).

**(SG5.6) VARIATIONS:** The scenario can be played again under different conditions by making one or more of the following changes:

**(SG5.61)** Use a different ship as the “police” player. Proposed ships are; Federation CL, Klingon D6, Kzinti CL, Gorn CL, or Romulan War Eagle. (There are many ships in other SFB products that could be used.)

**(SG5.62)** Have the “police” player select two small ships. There are many “police cutters” in other SFB products that could be used.

**(SG5.7) BALANCE:** The scenario can be balanced between players of different skill levels by one or more of the following:

**(SG5.71)** Allow one side to use fast (or faster) drones.

**(SG5.72)** Allow the “police” player to use a larger ship.

**(SG5.73)** Give one side its refit(s) but not the other side.

**(SG5.74)** Reduce the starting speed of one ship, which limits how fast it can accelerate on the first turn.

**(SG5.75)** Give one ship a higher weapons status.

**(SG5.8) TACTICS:** The Pirate is in over his head on this one, but with doubled engines and a massive first strike, he just might survive. The naval cruiser has the advantage of being able to take damage and continue the fight.

**(SG6.0) PURSUIT INTO THE ASTEROIDS**

by Stephen V. Cole, Texas

In this scenario a Navy cruiser is pursuing a Pirate towards its home base.

**(SG6.1) NUMBER OF PLAYERS:** 2; the “Navy” player and the “Pirate” player.

**(SG6.2) INITIAL SET UP**

**TERRAIN:** Deploy asteroids using the system outlined in (P3.1); alternatively, use one of the two Asteroid Maps in Captain's Module B.

**PIRATE:** Base in 4017, WS-I.

CR in 0517, heading B, speed max, WS-III.

**NAVY:** CA (any type) in 0327, heading B, speed max, WS-III.

**YEAR:** Players should select a year before set up. This year will define available ships, weapons, and refits. Y168 is assumed if no other decision is made.

**(SG6.3) LENGTH OF SCENARIO:** The scenario continues until all forces belonging to one side have been destroyed, captured, or have disengaged.

**(SG6.4) SPECIAL RULES**

**(SG6.41) MAP:** The map is fixed; it does not float. Any unit leaving the map has disengaged and cannot return. Any unit can disengage in any direction.

**(SG6.42) SHUTTLES AND PFs:** There are no PFs, fighters, or multi-role shuttles in this scenario, and this rule can be ignored. If playing this scenario using rules and components from other products (or the Kzinti CV), the player might choose to use these items. See (S1.3).

**(SG6.43) COMMANDER'S OPTION ITEMS**

**(SG6.431)** Each ship can purchase additional or special equipment as Commander's Option Items (e.g., T-bombs, extra marines, etc.) up to 20% of its Combat BPV. See (S3.2) for details and exceptions. Both players should spend the same total number of points.

**(SG6.432)** All drone speeds and types are available subject to agreement by the players on their use. Drone speed costs will increase the BPV of some ships. If you have Advanced Missions, see (S1.3) regarding the purchase of special drones.

**(SG6.44) REFITS:** All refits are available dependent on the year.

**(SG6.5) VICTORY CONDITIONS:** The Orion player scores 1 point if the cruiser disengages, 2 if it is crippled, 5 if it is destroyed, and 10 if it is captured. The Navy player scores 1 point if the CR is crippled, 3 if it is destroyed, and 10 if it is captured. The Navy player scores 4 points if the BS is crippled, 20 if it is destroyed or captured. The player with the higher score wins.

**(SG6.6) VARIATIONS:** The scenario can be played again under different conditions by making one or more of the following changes:

**(SG6.61)** Use Tactical Intelligence to identify the weapons on the Orion's units Option Mounts.

**(SG6.62)** Use two Orion CRs and allow the Navy Player one CA and one smaller ship.

**(SG6.7) BALANCE:** The scenario can be balanced between players of different skill levels by one or more of the following:

**(SG6.71)** Change the base to a BATS.

**(SG6.72)** Replace the Navy CA with two or three smaller ships.

**(SG6.73)** Randomly score 10 internals on the CR before the scenario begins.

**(SG6.8) TACTICS:** This base is easy to kill because it has no ph-4s.

Navy: Destroy the ship first, then pick up the base.

Pirate: Concentrate all fire on one Navy shield and hope a crippled cruiser will go away and leave you alone!

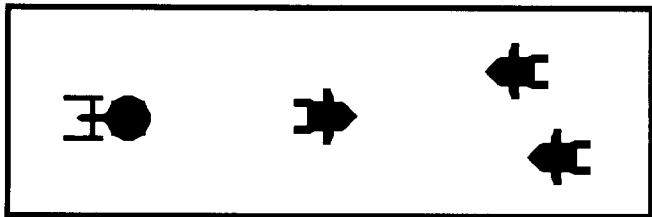
**(SG7.0) THE PIRATES GO FOR BIG GAME**

by Stephen V. Cole, Texas

On many occasions, a Pirate cruiser operated in a particular sector long enough to attract the attention of main fleet units. Usually this marked the end of the Pirate Captain's career as few Raiders could stand up to the heavy cruisers of the battle fleet. On a few occasions, however, when things just happened to work out right (or were made to work out right), a heavy cruiser in hot pursuit could find itself facing not one but two or even three Pirates and a stiff fight.

**(SG7.1) NUMBER OF PLAYERS:** 2; the Pirate player and the Navy player.

**(SG7.2) INITIAL SET UP**

**ORION:** CR in 2219, heading D, speed max, WS-III.

CR in 0725, heading B, speed 4, WS-III.

CR in 3625, heading F, speed 4, WS-III.

**NAVY:** One CA in 2203, heading D, speed max, WS-III.

**YEAR:** Players should select a year before set up. This year will define available ships, weapons, and refits. Y168 is assumed if no other decision is made.

**(SG7.3) LENGTH OF SCENARIO:** The scenario continues until all forces belonging to one side have been destroyed, captured, or have disengaged.

**(SG7.4) SPECIAL RULES**

**(SG7.41) MAP:** Use a floating map. Any unit can disengage in any direction.

**(SG7.42) SHUTTLES AND PFs:** There are no PFs, fighters, or multi-role shuttles in this scenario, and this rule can be ignored. If playing this scenario using rules and components from other products (or the Kzinti CV), the player might choose to use these items. See (S1.3).

**(SG7.43) COMMANDER'S OPTION ITEMS**

**(SG7.431)** Each ship can purchase additional or special equipment as Commander's Option Items (e.g., T-bombs, extra marines, etc.) up to 20% of its Combat BPV. See (S3.2) for details and exceptions.

**(SG7.432)** All drone speeds and types are available subject to agreement by the players on their use. Drone speed costs will increase the BPV of some ships. If you have Advanced Missions, see (S1.3) regarding the purchase of special drones.

**(SG7.44) REFITS:** All refits are available dependent on the players agreement to use them.

**(SG7.5) VICTORY CONDITIONS:** Use the Modified Victory Conditions (S2.2).

**(SG7.6) VARIATIONS:** The scenario can be played again under different conditions by making one or more of the following changes.

**(SG7.61)** Reverse the roles using three small Navy ships and one CR.

**(SG7.62)** Use a smaller fleet ship and only two CRs.

**(SG7.63)** Fight the scenario in an Asteroid Field (P3.0) or use one of the maps from Module B.

**(SG7.7) BALANCE:** The scenario can be balanced between players of different skill levels by one or more of the following:

**(SG7.71)** Allow the Navy player to be reinforced at a random time during the scenario.

**(SG7.72)** Allow one side to use faster drones.

**(SG7.73)** Delete or add a CR to the Pirate side.

**(SG7.74)** Apply some damage to the first CR.

**(SG7.8) TACTICS:** The Pirate has three ships, but must concentrate their firepower to cripple the cruiser. The cruiser should retain high speed to allow disengagement, but should generally try to cripple one Pirate with each alpha strike.

**(SG7.9) NOTES:** This is an excellent scenario for an experienced Navy player and a group of new players. When they can beat him, they are ready for bigger and better things.

Various Orion ships are provided in Advanced Missions and can be substituted for one or both of the ambushing CRs. Suggested are: one CA -or- four light raiders -or- one salvage cruiser carrying fighters or PFs.

**(SG8.0) ASSAULT ON A STARBASE**

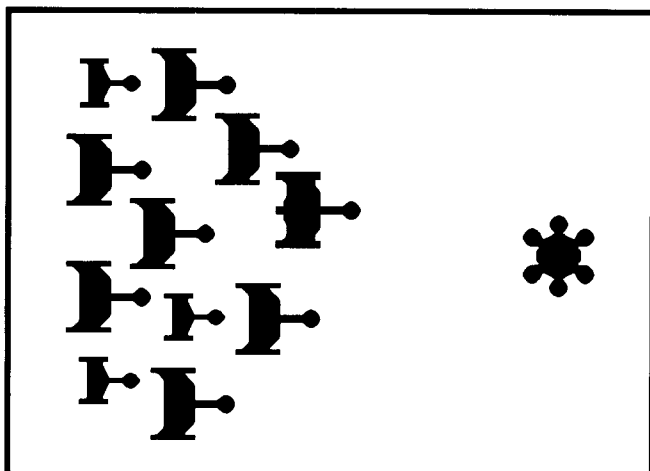

*Design by the Star Fleet Academy class of 1980*

The most practiced military action, and one that has seldom occurred, is the assault on a starbase by a main battle fleet. Endless debates are carried on in the command schools and service academies of all of the fleets as to the capability of fleet forces to destroy one of the "indestructible" starbases. The few actual assaults, some of which have been successful, are endlessly analyzed.

One of the problems in such an assault is that the attacking forces cannot exceed the command capabilities of their flagship, limiting the size of the force.

**(SG8.1) NUMBER OF PLAYERS:** 2; the attacking player and the defending player. (The attacking force may be broken into several smaller units, each requiring a player).

**(SG8.2) INITIAL SET UP**

**DEFENDING PLAYER:** One starbase in hex 2217, rotation speed 4, WS-II.

**ATTACKING PLAYER:** One main battle fleet [select from list in (SG8.61) below] arrives on any map edge (or two adjacent edges) on Turn #1, at any speed selected by the owning player, WS-III.

**YEAR:** Players should select a year before set up. This year will define available ships, weapons, and refits. Y168 is assumed if no other decision is made.

**BALANCE:** This scenario is not balanced. Players can reduce the BPV of the attacking forces to that of the SB, or you can add modules, fighters, PFs, minefields, and ships to the SB to equal the BPV of the attacking force.

**(SG8.3) LENGTH OF SCENARIO:** The scenario continues until all forces belonging to one side have been destroyed, captured, or have disengaged.

**(SG8.4) SPECIAL RULES**

**(SG8.41) MAP:** The map is fixed; it does not float. Any unit leaving the map has disengaged and cannot return. The Attacking units can only disengage from the map edges from which they entered. The Defending units can only disengage from the other map edges. Any unit disengaging from an unauthorized map edge is considered destroyed.

**(SG8.42) SHUTTLES AND PFs:** There are no PFs, fighters, or multi-role shuttles in this scenario, and this rule can be ignored. If playing this scenario using rules and components from other products (or the Kzinti CV), the player might choose to use these items. See (S1.3).

**(SG8.43) COMMANDER'S OPTION ITEMS**

**(SG8.431)** Each ship can purchase additional or special equipment as Commander's Option Items (e.g., T-bombs, extra marines, etc.) up to 20% of its Combat BPV. See (S3.2) for details and exceptions. Note that whatever is spent here counts in the Modified Victory Conditions (S2.2) as victory points for the enemy.

**(SG8.432)** All drone speeds and types are available subject to agreement by the players on their use. Drone speed costs will increase the BPV of some ships. If you have Advanced Missions, see (S1.3) regarding the purchase of special drones.

**(SG8.44) REFITS:** Players are free to determine the refit status of the ships so long as both agree.

**(SG8.5) VICTORY CONDITIONS:** Use the Modified Victory Conditions (S2.2).

**(SG8.6) VARIATIONS:** The scenario can be played again under different conditions by making one or more of the following changes:

**(SG8.61)** Use another race to attack the starbase.

RACE	FLEET
FEDERATION:	1xDN, 1xCC, 2xCA, 3xCL, 3xDD, 1xBT
KLINGON:	1xC8/9, 3xD7, 4xD6, 3xF5
KZINTI:	2xCV, 3xCS, 2xCL, 2xEFF, 1xFF
GORN:	4xCA, 3xCL, 3xDD
ROMULAN:	3xKR, 4xWE, 3xK5R

**(SG8.62)** Replace the starbase with a BATS and use only the three smallest ships (and one heavy cruiser) from each attack force.

**(SG8.63)** It would be possible that two races might join forces to attack a starbase. In such a case, each force of the alliance would use half of the specified main fleet in the attack.

**(SG8.7) BALANCE:** The scenario can be balanced between players of different skill levels by one or more of the following:

**(SG8.71)** Change one or more large ships to an equal number of smaller ships.

**(SG8.72)** Change one or more small ships to an equal number of larger ships.

**(SG8.73)** Add two or three ships to the starbase's side.

**(SG8.8) TACTICS:** Attacker: pull into range and pound the starbase into scrap rodinium! Defender: Use your ph-4s to cripple one attacking ship per turn. Federation fleets have a decisive advantage in their DDs and BTs, which can bombard a base from long range.

**(SG8.9) DESIGNER'S NOTES:** Advanced Missions will add minefields to the defense of starbases and thereby greatly increase the complexity of this operation.

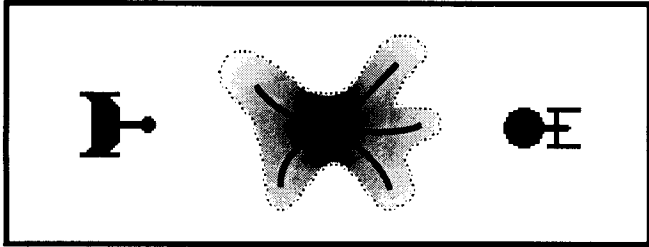
**(SG9.0) A VERY SPECIAL ALLY**

by Stephen V. Cole, Texas

This scenario represents a situation that is not covered by "the book." Investigating a report of a new monster in an outlying sector, a captain finds his target is being investigated by an enemy ship.

**(SG9.1) NUMBER OF PLAYERS:** 2 (Each player commands a starship. The monster moves by automatic rules.)

**(SG9.2) INITIAL SET UP**

**PLAYER A:** CA in 0101, heading C, speed max, WS-II.

**PLAYER B:** CA in 4030, heading F, speed max, WS-II.

**MONSTER:** Use a monster from any of the monster scenarios, or use the chart in (U2.11) to select one. In the case of scenario (SM5.0) from Advanced Missions, ignore the research base.

**YEAR:** Players should select a year before set up. This year will define available ships, weapons, and refits. Y168 is assumed if no other decision is made.

**(SG9.3) LENGTH OF SCENARIO:** The scenario continues until all forces belonging to one side have been destroyed, captured, or have disengaged.

**(SG9.4) SPECIAL RULES**

**(SG9.41) MAP:** Use a floating map. Player A's units can disengage from the 01xx and xx01 map edges. Player B's units can disengage only from the 42xx or xx30 map edges. Any units which disengages in an unauthorized direction is considered destroyed.

**(SG9.42) SHUTTLES AND PFs:** There are no PFs, fighters, or multi-role shuttles in this scenario, and this rule can be ignored. If playing this scenario using rules and components from other products (or the Kzinti CV), the player might choose to use these items. See (S1.3).

**(SG9.43) COMMANDER'S OPTION ITEMS**

**(SG9.431)** Each ship can purchase additional or special equipment as Commander's Option Items (e.g., T-bombs, extra marines, etc.) up to 20% of its Combat BPV. See (S3.2) for details and exceptions. Note that whatever is spent here counts in the Standard Victory Conditions (S2.2) as victory points for the enemy.

**(SG9.432)** All drone speeds and types are available subject to agreement by the players on their use. Drone speed costs will increase the BPV of some ships. If you have Advanced Missions, see (S1.3) regarding the purchase of special drones.

**(SG9.44) REFITS:** All refits are available dependent on the players agreement to use them.

**(SG9.45) RESEARCH:** Players accumulate research points as per (G4.1) in addition to attacking the monster itself and the enemy starship.

**(SG9.46) SOLUTION:** When a player accumulates 200 points of information, he may consult chart (S6.1) to determine how he can destroy the monster. (This chart is used no matter which monster is involved.) Result #6 is changed to read "The monster cannot be destroyed."

This chart is not consulted by die roll, but by drawing one die-cut counter from six upside-down and shuffled counters which are numbered "1" through "6." (Players may make such a set from blank counters or use six of the "drone" counters.) The first player to reach this information level picks one of the counters and then places it (after noting the number) upside down in any convenient place. When the other player has accumulated this level of information, he may see the counter previously picked. (This insures that both players discover the same "only way" to kill the monster.)

If the "need more info" result is picked, go ahead and place it face down (as if it were the real answer). When the second player reaches the information level and finds this counter (or when the first player reaches the amount needed for another attempt), reshuffle all six counters and draw again.

If the ship controlling the monster is destroyed, the owning player can maintain control of the monster from a shuttlecraft (if one of his is on the mapsheet). If his ship and all shuttles are destroyed, the monster returns to its randomly wandering nature.

**(SG9.47) COMMUNICATIONS:** At the start of any turn after accumulating 200 points of information, either player (or both if they both have that much information) may roll a die in an attempt to establish communication with the monster.

This die roll is increased by one for every 20 points (or any fraction thereof) of damage scored on the monster by that player. It is decreased by one for every 25 points of "information" in excess of 200 accumulated by that player. If the adjusted die roll is equal to or less than "1," the player has established communication with the monster.

Should both players establish such communication during the same turn, neither player has communication and they must roll again on the next turn.

Should either player disengage or be destroyed, the scenario is over and further communication die rolls are not made.

Successful communication by one player blocks the other player from attempting to gain communication.

**(SG9.48) CONTROL:** Upon establishing communication with the monster, a player controls it. Within its own rules, the player will direct where the monster is to go and when it is to attack.

Exception: The Space Amoeba (SM2.0), Mind Monster (SM6.0) and Cosmic Cloud (SM4.0) "attack" because of the nature of their beings. They cannot decline to attack a ship subject to attack under their rules. A player controlling such a monster is effectively limited to moving the monster in such a way as to keep his own ship outside of its lethal radius and to try to get the enemy ship inside that radius.

The Moral Eel (SM3.0), Sun Snake (SM5.0), and Planet Crusher (SM1.0) can all move and fire weapons as if they were a ship (within their own specific rules on movement and combat).

**(SG9.5) VICTORY CONDITIONS:** Use the Standard Victory Conditions (S2.2), but neither player gets any points for killing the monster.

**(SG9.6) VARIATIONS:** The scenario can be played again under different conditions by making one or more of the following changes:

**(SG9.61)** Add a third player and ship.

**(SG9.62)** Use a referee to determine damage to the ships, and have the players try to determine the enemy's capabilities through Tactical Intelligence (D17.0).

**(SG9.63)** Play the scenario over with each side using a smaller ship.

**(SG9.64)** Play the scenario in an Asteroid Field (P3.0), one of the terrain maps from Module B, or in some other type of terrain.

**(SG9.7) BALANCE:** The scenario can be balanced between players of different skill levels by one or more of the following:

**(SG9.71)** Have one player use a smaller ship.

**(SG9.72)** Require one player to gather more or fewer points to contact the monster.

**(SG9.73)** Only let one player have his refits.

**(SG9.8) TACTICS:** There are several options in this scenario, but they boil down to two sets of choices. First, a player can decide to close with the monster and attempt to gain information (and control), or he can avoid contact (and any chance of gaining control). The second set of options is to either fire at the monster or at the enemy ship. If your opponent moves close to the monster, consider firing at him in the hope that he will collapse when attacked from two sources. If he keeps away, consider maneuvering just a little closer to the monster than he is so that you will gain more information than he does, while keeping your weapons firing at him. Remember, research shuttles are fair game.

**END OF (SG0.0) BASIC SET**

## (SH0.0) HISTORICAL SCENARIOS

Historical scenarios are those which actually happened (within the fictional game universe anyway). As such, they are provided with specific forces, objectives, and rules. Even so, non-historical variants are included so that you can experiment with the dynamics of the situation.

Most of these scenarios do not include fighters or PFs (a type of small gunboat), which is appropriate since the Basic Set includes few fighters and no PFs (e.g., each scenario will state "there are no PFs in this scenario"). If you later acquire advanced products that include these units, you can add them to the scenarios at that time.

These scenarios include information (such as MRS shuttles and electronic warfare [EW] fighters) designed to allow the player to integrate new rules not included in the Basic Set. You can safely ignore any rules, units, or equipment mentioned in these scenarios but not included within products which you currently own. Should you later acquire additional products, such as Advanced Missions or one of the modules, the information to integrate the rules from those products is already present.

## (SH1.0) SABOTAGE



Y161

by Stephen V. Cole, Texas

While on a special mission during Y161, the Federation heavy cruiser *Kongo* was suddenly confronted by a Klingon battlecruiser. Fearing possible interference with his mission, Captain Phillip Kosnett ordered the warp engines brought to full power and discovered that they had been sabotaged! The science officer and chief engineer began frantic repairs as the enemy cruiser closed in for the kill.

**(SH1.1) NUMBER OF PLAYERS:** 2; the Federation player and the Klingon player.

### (SH1.2) INITIAL SET UP

**FEDERATION:** CA *Kongo* in 0823, WS-0, heading B, speed 1.

Captain Phillip Kosnett.

**KLINGON:** D7 *Antagonist* in 0405, WS-III, heading D, speed max.  
Commander Kagan.

**(SH1.3) LENGTH OF SCENARIO:** Until one ship is destroyed or captured or has disengaged.

### (SH1.4) SPECIAL RULES

**(SH1.41) MAP:** Use a floating map. Federation units can only disengage from the xx30 and 42xx map edges. Klingon units can only disengage from the xx01 and 01xx map edges. Units which disengage from unauthorized map edges are considered destroyed.

**(SH1.42) SHUTTLES AND PFs:** There are no PFs, fighters, or multi-role (MRS) shuttles in this scenario, and this rule (.42 through .423) can be ignored by a beginning player. If playing this scenario using rules and components from other products, the player might choose to add these items and the information presented here will be required. No shuttles in the historical scenario have warp booster packs (J5.0) as they had not been invented yet.

**(SH1.421)** Neither ship in this scenario carried an MRS shuttle (J8.0), but players may purchase these [up to the limits in (J8.5)] under (SH1.431) for experimental purposes.

**(SH1.422)** If you are playing the historical scenario, ignore this rule as no fighters were historically present. If you use the Kzinti CV under an alternative set up, use its standard fighters. If you have Advanced Missions or Module J, see (S1.3).

**(SH1.423)** If you only have Basic Set, ignore this rule. If you have Module K, see (S1.3) for PF data.

**(SH1.43) COMMANDER'S OPTION ITEMS:** Players should ignore this section [but not (SH1.432) below] when first playing the scenario, but might want to use it after gaining experience in the game.

**(SH1.431)** Each ship can purchase additional or special equipment as Commander's Option Items (e.g., T-bombs, extra marines, etc.) up to 20% of its Combat BPV. See (S3.2) for details and exceptions. Note that whatever is spent here counts in the Standard Victory Conditions (S2.2) as victory points for the enemy (SH1.5).

**(SH1.432)** All drones are "slow;" speed-8. The Klingon ship can purchase type-II and type-V drones (speed 12) as special drones. Special drones up to the historical percentages can be purchased as part of the Commander's Option Items.

**(SH1.44) REFITS:** Neither ship has any refits in this scenario.

**(SH1.45) SABOTAGE:** The warp engines of the Federation ship have been disabled by sabotage. They cannot be used, for any purpose, until repaired (they can be damaged). Repairs can be accomplished in one of two ways.

**(SH1.451)** On each turn (before energy allocation) except for Turn #1, the Federation player rolls a single die and records the result. When the total of these die rolls equals 13, his warp engines are repaired and operate normally.

**(SH1.452)** Instead of making the die roll, the Federation player may on any or all turns (except Turn #1) order the chief engineer to try to "crash start" the engines. In this case a die is rolled, and if a "1" is the result, the engines start immediately. However, if any other number is rolled, the attempt has failed and the engines are still inoperable. In this case the die roll result is NOT added to the total. The player MUST state, BEFORE rolling the die, which method he is using.

**(SH1.5) VICTORY CONDITIONS:** Use the Standard Victory Conditions (S2.2). The Federation player starts at a significant disadvantage and receives a bonus of 25 points.

**(SH1.6) VARIATIONS:** The scenario can be played again under different conditions by making one or more of the following changes.

**(SH1.61)** Replace one or both ships with those of another race.

**(SH1.62)** Replace one or both ships with a similar ship and use tactical intelligence (D17.0).

**(SH1.63)** Replace the ships with a Federation DD and a Klingon F5.

**(SH1.64)** Players could consider having a referee roll for the repairs in secret, not telling either player the result until repairs are accomplished. Crash starts are rolled by the player as per the normal rules.

**(SH1.65)** A beginning SFB player could use this scenario for training by playing it solitaire. Play the Klingon ship. Assume that the Federation ship uses his impulse energy for life support, shields, and one tactical maneuver (in that order) and uses his batteries to fire phasers at your drones (ignore the cost of active fire control for this purpose). Use the one tactical maneuver per turn to turn the ship after the first attack by you which on that turn penetrates one of the CA's shields (turn to bring a fresh shield toward your ship and/or any incoming drones; turn away from the axis of your approach). Do not use a scatter-pack as it will be too easy for you to win. The scenario is over when the Federation warp engines come on line. Try playing several times and see how much damage you can cause.

**(SH1.7) BALANCE:** The scenario can be balanced between players of different skill levels by one or more of the following changes. This scenario can be used between two opponents of unequal skill or ships of widely varying strength, with the better or more experienced player using the *Kongo*.

**(SH1.71)** Change the CA to a CL. (If you have Advanced Missions, you may want to use a GSC or an NCL.)

**(SH1.72)** Replace the D7 with a D6. (If you have Advanced Missions, you can try using a D5 or a D7C.)

**(SH1.73)** Add the (R2.R1) refit to the Federation ship or the (R3.R1) refit to the Klingon ship.

**(SH1.73)** Change all the Klingon drones to "medium;" speed 20.

**(SH1.74)** Lower the weapons status for the Klingon ship.

**(SH1.75)** Prohibit the Klingon from using a scatter-pack. (There are no scatter-packs in Basic Set.)

### (SH1.8) TACTICS

**FEDERATION:** You have a real problem. With four points of impulse power, you can manage life support, the shields, and one

tactical maneuver (to turn battered shields away from the enemy) per turn. If desperate, don't forget the zero energy turn (C5.13). On Turn #1, use one point of battery power to energize your phasers so that you will be able to fire them immediately when the engines are repaired. Launch three of the shuttles to get their phaser-3s into the battle, but keep one shuttle on board so that the Klingon will believe that you just could be arming a wild weasel. If using (SH1.431), buy T-bombs and use the transporters to put them between you and any approaching threat.

In Advanced Missions, the biggest threat is the Klingon scatter-pack as it can put *six* drones into one of your shields (while the pathetic drone racks on these early Klingons can fire only one drone per turn). You could use two points of battery power to arm a wild weasel (the only defense against a scatter-pack), but the Klingon will probably tractor you to prevent its use. You might do better to use the batteries to power the phasers (perhaps as phaser-3s) and fire control to kill the scatter-pack's drones (or the scatter-pack itself if you want to gamble on which of his two shuttles it is!).

**KLINGON:** Your job is easy against such a helpless target, but there is no time to waste as once the CA's engines are repaired you will be facing superior firepower. Fortunately, once the engines are on line, it will be the next turn before the photons can fire. If his engines are repaired (and his ship is not damaged), move at maximum speed and disengage after a final volley. (If the *Kongo* is damaged, particularly if it has lost a photon or two, you may as well stay and fight.) Achieving maximum firepower will require a scatter-pack (consider using *both* shuttles for scatter-packs, even though you have to unload one drone rack). Use overloaded disruptors but keep your speed at 15 so that you can disengage on the next turn. Just get close to him and *pound, pound, pound* on one of his shields. (Use multiple volleys on the same down shield to get extra "Column A" hits and destroy more weapons. This is known as the "Mizia Concept" after the captain who first devised it.) Maneuver to allow *all* of your phasers to fire on *every* turn. Grab him with a tractor to prevent him from using a WW. Kill his shuttles (with tractor beams, preferably) when they appear. You get the same "kill bar" if he blows up before or after his engines are repaired, so give yourself a break and kill him quickly. If his photons are already destroyed when his engines come on line, he will be trying to disengage. Don't let him!

**HISTORICAL OUTCOME:** The *Kongo* was damaged, but managed to crash start the engines. Commander Kagan, never interested in a fair fight, broke contact and left Kosnett licking his wounds (although he was able to complete the assigned mission). The damaged *Kongo* returned to a starbase for repairs and was converted to a command cruiser. Kosnett eventually became the second most famous captain in the Federation Fleet.

## (SH2.0) THE SURPRISE REVERSED

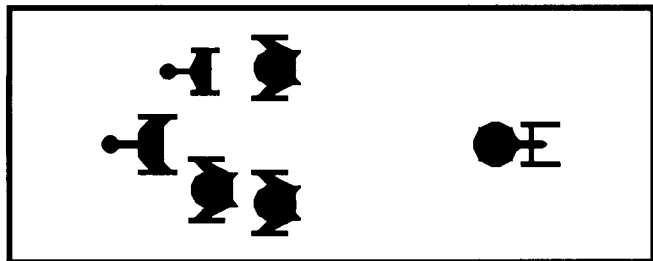

Y173

by Stephen V. Cole, Texas

Through effective intelligence (and a bit of luck), Commodore Anthony J. Stocker of the Federation command cruiser *Lexington*, on frontier patrol near the Romulan border, learned that the Romulans intended to launch an undeclared war. As predicted by intelligence, a Romulan task force appeared on schedule, just across the Neutral Zone. Stocker knew that they would not launch their attack for several hours. He judged that they were anticipating total surprise and were not fully alert, and he decided on a bold maneuver: cross the border immediately; destroy or cripple as many of their ships as possible; and then escape at full speed, falling back on the nearest base. While

this maneuver was technically an act of war, Stocker considered that to be irrelevant under the circumstances.

**(SH2.1) NUMBER OF PLAYERS:** 2; The Federation player and the Romulan player.

### (SH2.2) INITIAL SET UP

**TERRAIN:** Neutral Zone from hex 0126 to 4205 (one hex wide).

**FEDERATION:** CC *Lexington* in hex 0621, WS-III, heading B, speed 10. Commodore Tony Stocker.

**ROMULANS:** KR in hex 1820, heading B, speed 1, WS-0.

WE in hex 1720, heading B, speed 1, WS-0.

K5R in hex 1821, heading B, speed 1, WS-0.

WB+ in hex 1620, heading B, speed 1, WS-0.

WB+ in hex 1722, heading B, speed 1, WS-0.

**(SH2.3) LENGTH OF SCENARIO:** The scenario continues until all forces belonging to one side have been destroyed, captured, or have disengaged.

### (SH2.4) SPECIAL RULES

**(SH2.41) MAP:** Use a floating map. Federation units can only disengage from the xx01 and 01xx map edges. Romulan units can only disengage from the xx30 and 42xx map edges. Units which disengage from unauthorized map edges are considered destroyed.

**(SH2.42) SHUTTLES AND PFs:** There are no PFs, fighters, or multi-role (MRS) shuttles in this scenario, and this rule (.42 through .423) can be ignored by a beginning player. If playing this scenario using rules and components from other products, the player might choose to add these items and the information presented here will be required. No shuttles in the historical scenario have warp booster packs (J5.0) as they had not been invented yet.

**(SH2.421)** If using the optional MRS shuttles (J8.0), the Federation CC and Romulan KR could each have an MRS purchased under (SH2.431). (The KR would have an MRS-F; the plasma-F is unarmed.)

**(SH2.422)** If you are playing the historical scenario, ignore this rule as no fighters were historically present. If you use the Kzinti CV under an alternative set up (SH2.6), see (SH2.61). If using EW fighters (R1.F7) from Advanced Missions or Module J, see (S1.3).

**(SH2.423)** There are no PFs in this scenario, but players with access to Module K might choose to add PFs within those rules. If PFs are added to the scenario, see (SH2.61) and (S1.3).

### (SH2.43) COMMANDER'S OPTION ITEMS

**(SH2.431)** Each ship can purchase additional or special equipment as Commander's Option Items (e.g., T-bombs, extra marines, etc.) up to 20% of its Combat BPV. See (S3.2) for details and exceptions. Note that whatever is spent here counts in the Modified Victory Conditions (S2.2) as victory points for the enemy.

**(SH2.432)** All drones are "medium;" speed-20. The Federation CC can purchase special drones up to the historical percentages as part of the Commander's Option Items.

**(SH2.44) REFITS:** The Federation CC has the (R2.R1) refit. The Romulan KR and K5R have the (R4.R1) refit. The WE has the (R4.R4) refit.

**(SH2.45) SURPRISE:** The surprised ships must obey certain restrictions until they are "released." They may not move faster than one hex per turn, arm any weapons, arm or launch any shuttles or other weapons, use erratic maneuvering, operate electronic warfare systems, make high energy turns, or operate their shields at other than "minimum" level. They cannot reinforce shields; operate tractors; use reserve power, transporters, or cloaking devices; and only half of their boarding parties (round fractions up) are available for use. Their fire control is active at start, and it can not be turned off until after the first impulse the Federation ship fires any weapon or a seeking weapon launched by the CC hits a Romulan ship. Tractoring an enemy ship is considered an "attack" for this purpose.

**(SH2.46) RELEASE:** The surprised ships are "released" as follows: At the end of the turn during which the Federation ship entered the Neutral Zone OR fired at any Romulan ship, a die is rolled for each inactive ship. If the die roll is a "1" or "2," the ship is "released" for the next turn and may operate normally. If the die roll is "3," "4," "5," or "6," the ship is not released. Note that, even after a ship is released, it will still have to arm weapons and build up speed. Unreleased ships roll again at the end of each turn. If you have Advanced Missions, do not use (D18.0) but instead use the rules stated here.

**(SH2.47) SHUTTLES** may not cross the Neutral Zone before their ship does.

**(SH2.5) VICTORY CONDITIONS:** Use the Modified Victory Conditions (S2.2), except that the Federation ship is not penalized for disengaging.

**(SH2.6) VARIATIONS:** The scenario can be played again under different conditions by making one or more of the following changes:

**(SH2.61)** Ships of any race can be substituted on either side. The table below provides the players with a selection of forces for each side. Two different races should be used. For the purposes of this chart, the Federation ship (above) is "Ship #1," the Romulans are "Force #2."

RACE	Ship #1	Force #2
Federation	CC or CA	1xCA, 2XCL, 2xDD*
Klingon	D7 or D6	1xD7, 2xD6, 2xF5
Romulan	KR or WE	1xKR, 1xWE, 2xWB, 1xK5R
Kzinti	CS	1xCV, 1xCS, 1xCL, 2xFF
Gorn	CA	1xCA, 2xCL, 2xDD

\*The Federation would never launch a surprise war; this force is provided for player analysis of non-historical possibilities.

Use the same set-up hexes. If there is a carrier in Force #2, roll one die and subtract three from the result (less than 0 is 0). This is the number of fighters that may be placed on the board (within four hexes of the carrier) as a combat space patrol. If there is a PFT in Force #2, one of its standard PFs may be placed on the board within four hexes of the PFT (WS-1). These fighters/PFs are released immediately if Ship #1 fires across or enters the Neutral Zone. Refits can be used for balance.

Fighters or PFs from Ship #1 may cross the Neutral Zone before the ship, but the release rules are triggered by these fighters/PFs as if the ship itself had attacked. The combat space patrol fighters would be fully armed.

**(SH2.62)** Replace some of the ships with equivalent hull types and use the tactical intelligence rule (D17.0).

**(SH2.63)** For a smaller scenario, reduce the numbers and sizes of the ships as follows:

RACE	Ship #1	Force #2
Federation	DD	1xCL, 2xDD*
Klingon	F5	1xD6, 2xF5
Romulan	K5R	1xWE, 2xWB
Kzinti	CL	1xCL, 2xFF
Gorn	CL	1xCL, 2xDD

\*The Federation would never launch a surprise war; this force is provided for player analysis of non-historical possibilities.

**(SH2.64) INTEGRATION WITH FUTURE PRODUCTS:** Ships in future products may be used in this scenario (in addition to those above) as follows:

RACE	Ship #1	Force #2
Federation	NCL or BCH	1xDN, 1xCA, 1xNCL, 2xDD or FF*
Klingon	D5 or C7	1xC8/9, 3xD6
Romulan	SpH-A	1xCondor, 2xKR, 2xK5R
Romulan	KRC	1xKRB, 1xWE, 1xK5RB, 1xBH, 1xSnipe-A†
Romulan	KE	1xCondor, 2xSpH-A, 2xSkH-A
Gorn	HDD or CM	1xDN, 1xCA, 1xHDD, 2xBDD
Kzinti	CM or BC	1xSCS, 2xCM, 2xFF
Tholian	C, CA, or CC	1xD, 1xBW, 1xC, 2xPC
Hydran	Ranger	1xPal, 1xRN, 1xLN, 2xHN

Hydran	Dragoon	1xPal, 1DR, 1xKN, 2xCuir
Lyrans	CA or CW	1xLion, 1xTiger, 1xJaguar, 2xLeopard
LDR	CL or CW	1xBC, 1xTiger, 1xJaguar, 2xMilitary Police‡
ISC	CA or CS	1xCC, 1xCL, 2xDD, 1xFF

\* The Federation would never launch a surprise war; this force is provided for player analysis of non-historical possibilities.

† This is, in fact, the "historical" Romulan force, but some of these units are not available in the Basic Set.

‡ This would be a total disaster for the LDR, which would probably be wiped out after such a defeat.

Obviously, many other combinations of ships could be used. Just about any of the 100 or so cruisers in the game could be used for Ship #1. Refits can be used for play balance.

**(SH2.65)** This scenario can be used for solitaire training by a new player. Set up the Romulan ships and conduct your attack. Your ship must recross the border on Turn #3. Keep track of your score and determine which combinations of targets and weapons produce the best results.

**(SH2.7) BALANCE:** The scenario can be balanced between players of different skill levels by one or more of the following:

**(SH2.71)** Change one or both WB+s to WEs; this slightly favors the Romulans.

**(SH2.72)** Replace the Federation CC with a CL; this greatly favors the Romulans.

**(SH2.73)** Delete the (R2.R1) refit from the Federation CC; this slightly favors the Romulans.

**(SH2.74)** Make the smallest Romulan ship active and at WS-0 (and use a larger Federation ship).

**(SH2.8) TACTICS**

**FEDERATION:** Select an enemy ship, cross the border at a speed that will allow you to get behind him at a range of one hex at the end of the turn, and hit that ship with overloaded weapons in a concentrated volley. Do not overlook the potential of your administrative shuttles (used in a suicide mode). T-bombs could be scattered ahead of the Romulan ships or used to cover your withdrawal. If more than one uncrippled Romulan ship is released at the end of a turn (including any released on prior turns), fire your last volley, turn for the border, and disengage. If using the historical OB in Advanced Missions, use your scatter-pack!

**ROMULAN:** First, you pray. Then, you wait for your ships to become active and do the best you can with what is left. Use the two-turn-F rule (FP1.93) to get some torpedoes on the board quickly.

**HISTORICAL OUTCOME:** Stocker destroyed the KR, the Snipe, and the K5R (SH2.64). Running for his base, Stocker decided to set a trap for one of the pursuing Romulan ships (destroying the Battle Hawk), but was in turn attacked by the War Eagle. The *Lexington* was all but destroyed, and the detached saucer section successfully hid in the atmosphere of a gas giant until rescued by another ship.

The Romulans always insisted that they had not been on the verge of war, but were only conducting a defensive deployment maneuver when Stocker launched his unprovoked attack. The Romulans claim that they launched their invasion only in an effort to disrupt what they assumed to be an impending Federation assault, and they discovered too late that the Federation attack had been only one deranged captain.

**(SH3.0) THE COMING OF THE METEOR**

Y160

by Stephen V. Cole, Texas

In Y160 a massive meteor was spotted headed for the industrial colony on Pollux IX. The Federation heavy cruiser *Kongo*, under the command of Captain Phillip Kosnett, was dispatched to avert the disaster. When *Kongo* arrived on the scene, however, Kosnett discovered that a Klingon frigate was shepherding the meteor.

**(SH3.1) NUMBER OF PLAYERS:** 2; the Federation player and the Klingon player.

**(SH3.2) INITIAL SET UP**

**TERRAIN:** One class-M planet in hex 3020.

One large asteroid (use moon counter) in hex 2015.

**FEDERATION:** CA *Kongo* in hex 4209, heading E, speed max, WS-II. Captain Phillip Kosnett.

**KLINGON:** F5 *Khedive* in hex 2016, heading C, speed 1, WS-I. Lieutenant Commander Kremler.

**(SH3.3) LENGTH OF SCENARIO:** The scenario continues until the asteroid hits the planet or enters a hex beginning with "32."

**(SH3.4) SPECIAL RULES**

**(SH3.41) MAP:** The map is fixed; it does not float. Any unit leaving the map has disengaged and cannot return. Federation units can only disengage from the xx01 and 42xx map edges. Klingon units can only disengage from the xx30 and 01xx map edges. Units which disengage from unauthorized map edges are considered destroyed.

**(SH3.42) SHUTTLES AND PFs:** There are no PFs, fighters, or multi-role (MRS) shuttles in this scenario, and this rule (.42 through .423) can be ignored by a beginning player. If playing this scenario using rules and components from other products, the player might choose to add these items and the information presented here will be required. No shuttles in the historical scenario have warp booster packs (J5.0) as they had not been invented yet.

**(SH3.421)** Neither ship in this scenario carried an MRS shuttle (J8.0), but players may purchase these [up to the limits in (J8.5)] under (SH3.431) for experimental purposes.

**(SH3.422)** If you are playing the historical scenario, ignore this rule as no fighters were historically present. If you use the Kzinti CV under an alternative set up, use its standard fighters. If you have Advanced Missions or Module J, see (S1.3).

**(SH3.423)** If you only have Basic Set, ignore this rule. If you have Module K, see (S1.3) for PF data.

**(SH3.43) COMMANDER'S OPTION ITEMS**

**(SH3.431)** Each ship can purchase additional or special equipment as Commander's Option Items (e.g., T-bombs, extra marines, etc.). Each player has 10 points to spend for this equipment; see (S3.2) for additional data.

**(SH3.432)** All drones are "slow;" speed-8. Type-II and type-V drones (speed 12) are available for purchase as special drones.

The F5 can purchase special drones up to the historical percentages as part of the Commander's Option Items. Most of these special drones are, of course, not available in Basic Set.

**(SH3.44) REFITS:** No ship in this scenario has a refit.

**(SH3.45) METEOR MOVEMENT:** On the first impulse of each turn, the meteor moves one hex in direction C. If, in doing so, it enters a hex containing a ship or shuttle, that unit is destroyed. In this case, the explosion blast (if any) would count as damage to the asteroid; see (SH3.47).

**(SH3.46) TOWING:** A starship could "tow" the asteroid, hoping to move it out of (or back into) the path toward the planet. To do this, the ship must spend at least one-half of a turn adjacent to the meteor, facing away from it, and with a point of power applied to one tractor beam. The meteor is moved into the ship's hex (and the ship is moved forward one hex) at the instant these conditions are satisfied; the size and movement cost of the "towing" ship has no effect on this. A given ship can only move the meteor once per turn. The effect of this movement is solely to move the meteor onto a path parallel with

its original path; the meteor still moves one hex in direction C each turn regardless of what the ships do to it.

**(SH3.47) DESTRUCTION:** The meteor cannot be destroyed, but it could be "broken up" into smaller fragments by weapons fire. If 400 points of damage is scored on the meteor, it breaks up into fragments [see (P2.312)]. Replace the moon with an asteroid counter. Suicide shuttles, drones, and ships crashing into it (use self-destruction procedure to calculate damage caused by the impact) all count towards this total. If shattered, the meteor can still be towed; all of the fragments remain in the same hex.

**(SH3.48) KLINGON WITHDRAWAL:** The Klingon player can, at the start of any impulse, declare that this was all a horrible mistake. (He was not escorting the meteor, but was just observing it, and if he did fire at the Federation ship, he certainly didn't mean it.) From that point, the Federation player cannot attack the Klingon ship and the Klingon ship cannot attack the Federation ship. This includes seeking weapons (tracking must be cut to any in flight) and tractor beams. The Klingon ship cannot tractor the meteor if he declares "peaceful intentions."

**(SH3.5) VICTORY CONDITIONS**

The planet is inhabited by one million sentient residents. Their survival is the only basis for determining victory.

If the meteor enters the planet hex, the planet is totally destroyed and all inhabitants perish. Klingon Total Victory.

If the meteor passes through a hex adjacent to the planet, fragments strike the planet and 900,000 of the inhabitants perish. Klingon Tactical Victory.

If the meteor passes within 2 hexes of the planet, smaller fragments strike the planet and 100,000 of the inhabitants perish. Draw.

If the meteor is reduced to asteroids, and they strike the planet, 900,000 of the inhabitants perish. Klingon Tactical Victory.

If the meteor is reduced to asteroids, and they pass through a hex adjacent to the planet, small fragments cause 100,000 of the inhabitants to perish. Draw.

If the meteor does not damage the planet, Federation Decisive Victory.

**(SH3.6) VARIATIONS** The scenario can be played again under different conditions by making one or more of the following changes:

**(SH3.61)** Use similar ships from any two mutually antagonistic races.

**(SH3.62)** Add a Klingon D6 and a Federation CL.

**(SH3.63)** Substitute a squadron of Kzinti Fighters for the F5.

**(SH3.7) BALANCE:** The scenario can be balanced between players of different skill levels by one or more of the following:

**(SH3.71)** Change the CA to a CC or CL.

**(SH3.72)** Replace the F5 with a D6.

**(SH3.73)** Increase or decrease the distance between the planet and the meteor. Players might "bid" for this distance, with the low bidder taking the ship defending the planet and the distance between the planet and meteor equal to his bid.

**(SH3.74)** Give one player a higher or lower weapons status.

**(SH3.8) TACTICS**

**FEDERATION:** You have to do everything at once. Hit the frigate with an alpha-strike of overloaded photons, grab the meteor with a tractor beam, and *pull!* You might consider leaving some of your photons unarmed after the first volley to spend more power on the tractor, electronic warfare, and shields.

**KLINGON:** Your mission is to distract the attention of the Federation ship, remain in the area in case a chance to pull the meteor back onto its path presents itself, and damage the Federation ship if you can.

**HISTORICAL OUTCOME:** In the greatest traditions of the Star Fleet, Kosnett managed to tow the meteor out of its path without damaging the *Khedive*. Kosnett carefully limited his fire on the Klingon ship to shield damage, putting Kremler in a very vulnerable position with the implied threat of a photon salvo. No fool, Kremler declared "peaceful intentions" and returned to the Klingon border. Kosnett and the *Kongo* remained on the Klingon border; see (SH1.0).

The Klingons could not punish Kremler without admitting what was really going on, and his career did not suffer. Later, Kremler would encounter the *Kongo* while in command of the D6 *Gnasher* (during the massacre at Rita's Planet).

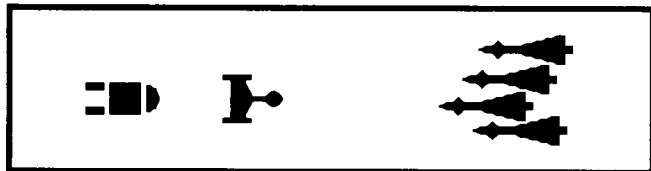

**(SH4.0) CRUISE DRONES**

Y158

by Stephen V Cole, Texas

During the Klingo-Kzinti War of Y158, a Klingon border station needed a critical replacement part for its tracking sensors. This part (which weighed several tons) was loaded onto a small freighter and dispatched toward the border under escort of a frigate. Reaching the front lines, the frigate and freighter managed to evade several attempts at interception. Finally, with their goal in sight, the ships felt secure. The Kzintis launched one last attempt to destroy the ship, using their new "long-lance" type III-XX cruise drones.

**(SH4.1) NUMBER OF PLAYERS:** 1 (The drones appear and move by automatic rules). As an alternative, a second player could maneuver the drones (although he cannot affect their arrival times or locations).

**(SH4.2) INITIAL SET UP**

**KLINGON:** Small freighter in 0110.

F5 *Vandal* in 0108. Lt Commander Keng.

Both at WS-I, heading at player's option, speed 4.

**(SH4.3) LENGTH OF SCENARIO:** The scenario lasts until the freighter leaves the map from a hex in the 4200 row or is destroyed.

**(SH4.4) SPECIAL RULES**

**(SH4.41) MAP:** The map is fixed; it does not float. Any unit leaving the map has disengaged and cannot return. The Klingon units can disengage from any map edge.

**(SH4.42) SHUTTLES AND PFs:** There are no PFs, fighters, or multi-role (MRS) shuttles in this scenario, and this rule (.42 through .423) can be ignored by a beginning player. If playing this scenario using rules and components from other products, the player might choose to add these items and the information presented here will be required. No shuttles in the historical scenario have warp booster packs (J5.0) as they had not been invented yet.

**(SH4.421)** Neither ship in this scenario carried an MRS shuttle (J8.0), but players may purchase these [up to the limits in (J8.5)] under (SH4.431) for experimental purposes.

**(SH4.422)** If you are playing the historical scenario, ignore this rule as no fighters were historically present. If you use the Kzinti CV under an alternative set up, use its standard fighters. If you have Advanced Missions or Module J, see (S1.3).

**(SH4.423)** If you only have Basic Set, ignore this rule. If you have Module K, see (S1.3) for PF data.

**(SH4.43) COMMANDER'S OPTION ITEMS**

**(SH4.431)** The F5 ship can purchase additional or special equipment as Commander's Option Items (e.g., T-bombs, extra marines, special drones, etc.) up to 20% of its Combat BPV. See (S3.2) for details and exceptions, particularly if using a different ship.

**(SH4.432)** All Klingon drones are "slow," speed-8. The Kzinti type-III drones are speed 12; see (FD2.1). Type-II and type-V drones (speed 12) are available to the F5 for purchase as special drones as part of the Commander's Option Items.

**(SH4.44) REFITS:** No ships are refitted in this scenario.

**(SH4.5) DRONE ARRIVAL:** Each turn, from 4 to 9 "cruise drones" (type-III-XX) appear on the upper map edge (roll one die and add three to determine the number). Use the Kzinti drone counters and use them in numerical sequence. As each turn's drones appear, place the first one in the hex ending with "01" in the same column as the freighter and place the others in hexes ending with "01" moving toward the higher numbered side of the map. Example: If the freighter was in hex 1415, and three drones were to appear, they would be placed in hex 1401, 1501, and 1601.

**(SH4.46) DRONE TARGETING:** Odd numbered drones are targeted on the freighter, even numbered ones on the frigate.

**(SH4.47) FREIGHTER:** The freighter is limited to a maximum speed of 4 because of its delicate cargo.

**(SH4.48) GUIDANCE:** The "cruise" drones do not require external guidance; see (FD5.255) for the Wild Boar procedure.

**(SH4.5) VICTORY CONDITIONS:** If the freighter leaves the map from a hex in the "4200" column with at least 10 undestroyed cargo boxes, the Klingon wins the scenario. Any other result is a loss.

**(SH4.6) VARIATIONS:** The scenario can be played again under different conditions by making one or more of the following changes:

**(SH4.61)** Replace the F5 with a Kzinti FF or a Fed DD.

**(SH4.62)** Use two small escorts (E4s), and roll two dice to determine the number of cruise drones.

**(SH4.63)** Other civilians ships (such as an armed priority transport or Federation Express from Advanced Missions) could be substituted for the freighter. Faster cruise drones could be used against an aegis escort. A large Q-ship could carry the part without an escort (maybe).

**(SH4.64)** Use "medium" speed 20 or "fast" speed 32 drones and a cruiser as escort.

**(SH4.65)** If you have Advanced Missions, consider using any of the F5 variants (F5E escort, F5D drone ship) or other Klingon ships, such as the D5, F5L, E5, or F6. Similarly, the various Lyran or Hydran ships in Module C1 could be used in this scenario.

**(SH4.66)** This can be converted to a two-player scenario. Allow the Kzinti player (who has only drones) to program the entry hexes of the drones in advance and to replace historical percentages of them with special drones from Advanced Missions.

**(SH4.7) BALANCE:** The scenario can be balanced by one or more of the following:

**(SH4.71)** Change the small freighter to a large freighter. If you have Advanced Missions or other modules, you might consider an armed freighter or a Q-ship.

**(SH4.72)** If fast or medium drones are used, allow only a maximum of six drones per turn.

**(SH4.73)** Beginning players might use a Klingon D6 (or even a D7). Once you are winning the scenario consistently, use the F5 in the standard scenario. Expert players might attempt to use a single E4.

**(SH4.8) TACTICS:** Keep the freighter moving, and kill any drone that comes near. Deploy the admin shuttles from the freighter and the F5 for additional firepower. (Don't waste time with a wild weasel as the phaser-3 can kill more drones over the length of the scenario than are locked-onto the ships at any given time.) Disruptors cannot hit the drones effectively at more than point blank range. Protection of the freighter is paramount; your frigate may have to take a hit or two. That's what shields are for; after all, nothing else is shooting at you.

**(SH4.9) COMMENTS:** As this is a solitaire scenario, it is always available when you have time to play but no opponent. Even after progressing to other modules, you can always try a new combination of ships and drones.

**HISTORICAL OUTCOME:** Keng succeeded in delivering the cargo, but his ship was very nearly destroyed and he feared being relieved from command. His first officer unexpectedly testified as to the brilliance of Keng's maneuvers; however, and the admiralty promoted Keng to be XO (and later commander) of the battlecruiser *Pitiless*. The first officer went on to command *Vandal*, which eventually became the most famous of all Klingon frigates.

**(SH5.0) THE DESTRUCTION OF  
ATTACK SHUTTLE GROUP #26**

Y166

by Stephen V. Cole, Texas

Shortly after the introduction of the attack shuttle carrier, a particularly cunning Klingon officer (Lieutenant Commander Ardak Kumerian, commanding the frigate *Vigilance*) reasoned that, since the attrition rate on attack shuttles was on the order of 25%, there must be a source of extra shuttles somewhere in the Kzinti supply system.

Taking his frigate on a long circuit around the lead Kzinti elements, he found what he was looking for: freighter FV-41, carrying attack shuttle group #26, a back-up unit for the CV *Sabre*, flagship of the Kzinti 3rd Field Force of the Duke's Fleet.

**(SH5.1) NUMBER OF PLAYERS:** 2; the Kzinti player and the Klingon player.

**(SH5.2) INITIAL SET UP**

**KZINTI:** Auxiliary Light Carrier *FV-41* in 2217 (12 AAS fighters), heading E, speed 4, WS-0. Captain 5th Rank Cat Who Sleeps.

**KLINGON:** F5 *Vigilance* in 4025, heading F, speed 10, WS-I. Lieutenant Commander Ardak Kumerian.

**(SH5.3) LENGTH OF SCENARIO:** The scenario continues until all forces belonging to one side have been destroyed, captured or have disengaged. If the F5 has not disengaged by the end of Turn #10, it is destroyed.

**(SH5.4) SPECIAL RULES**

**(SH5.41) MAP:** Use a floating map. The fighters have not been fueled for a long flight and cannot disengage under (C7.13). They can disengage by separation. Klingon units can only disengage from the xx30 map edge; the Kzinti units can disengage from any other map edge. Units which disengage from unauthorized map edges are considered destroyed.

**(SH5.42) SHUTTLES AND PFs:** There are no PFs or multi-role (MRS) shuttles in this scenario, and this rule (.42 through .423) can be ignored by a beginning player. If playing this scenario using rules and components from other products, the player might choose to add these items and the information presented here will be required. No shuttles in the historical scenario have warp booster packs (J5.0) as they had not been invented yet.

**(SH5.421)** Neither ship in this scenario is qualified to carry an MRS shuttle (J8.0). Players may purchase these [up to the limits in (J8.5)] under (SH5.431) if a qualified ship is substituted.

**(SH5.422)** There are no EW fighters in this scenario. (They had not been invented yet.) There is no chaff (D11.0); it had not been invented yet.

**(SH5.423)** If you only have Basic Set, ignore this rule. If you have Module K, see (S1.3) for PF data.

**(SH5.43) COMMANDER'S OPTION ITEMS**

**(SH5.431)** Each ship can purchase additional or special equipment as Commander's Option Items (e.g., T-bombs, extra marines, etc.) up to 20% of its Combat BPV. See (S3.2) for details and exceptions.

**(SH5.432)** All drones are "slow;" speed-8. Type-II, type-V (speed 12) and "medium" (speed 20) drones are available for purchase as special drones.

The F5 can purchase special drones up to the historical percentages as part of the Commander's Option Items.

**(SH5.44) REFITS:** There are no refits in this scenario.

**(SH5.45) DECK CREWS:** The AuxCVL has only four deck crews (the rest were taken by the *Sabre* to replace losses). Because the fighters are not prepared for a combat launch, each fighter must be "prepared" before it can be launched. This preparation requires one deck crew for one turn. (The result is that the AuxCVL cannot launch

any fighters on Turn #1 and only four per turn thereafter. Prepared fighters can be held and launched on later turns.)

**(SH5.46) DRONES:** The AuxCVL has no drones aboard as these had all been transferred to the KHS *Sabre* earlier, so it cannot arm the attack shuttles with drones or prepare scatter-packs. The ADD racks cannot use (E5.4). (If using an AuxCVL from another race or other types of fighters, the fighters have no weapons except phasers.)

**(SH5.5) VICTORY CONDITIONS:** The Klingon player wins by destroying at least 10 of the attack shuttles without being destroyed. The Kzinti player wins by either destroying the Klingon and still having some of his attack shuttles left or crippling the Klingon and forcing him to disengage while losing less than six attack shuttles. The fate of the AuxCVL is essentially irrelevant to this basic requirement; however, if it is destroyed in addition to all of the attack shuttles being destroyed, the Klingon wins an outstanding victory. If it is captured, the Klingon wins an amazing victory.

**(SH5.6) VARIATIONS:**

**(SH5.61)** If you have Advanced Missions, substitute an AuxCVL and a frigate from any two mutually antagonistic races.

**(SH5.62)** Substitute a D6 or D7 for the F5 and a CV for the AuxCVL. The CV would still be under the restrictions of (SH5.45) and (SH5.46).

**(SH5.7) BALANCE:** The scenario can be balanced between players of different skill levels by one or more of the following:

**(SH5.71)** Change the F5 to an E4.

**(SH5.72)** Replace the AuxCVL with a Q-Ship.

**(SH5.73)** Give the F5 the (R3.R1) refit.

**(SH5.8) TACTICS**

**KLINGON:** Get close to the AuxCVL fast, and stay on top of him. Only fire at it near the end of turns, and then only with overloaded disruptors. Remember, at point blank range your disruptors will not miss the fighters, and you can kill up to five of his fighters a turn. Only launch drones when you are sure they will do you some good by either drawing his phasers or hitting a target. If you have Advanced Missions, consider a scatter-pack.

You can use Kumerian's Gambit (if you are brave, stupid, and/or lucky enough to pull it off). Tractor the AxCVL to keep the fighters from launching, destroying the fighters on the carrier.

**KZINTI:** You have to run and fight. Get up as much speed as you can, and keep firing your phasers at him; at close range, which is where he wants to be, they are almost as good as his disruptors. Keep him moving as fast as you can (by encouraging him to chase you) as this will make it hard for him to charge the disruptors and recharge his phasers. Watch for his drones; if he is close in, they may hit you before you can defend yourself from them. Send some fighters in all directions, but keep some on board the ship. Do not forget to use your admin shuttles as fighters; their phaser-3s could make a difference. If you see his shuttle, kill it quick!

**HISTORICAL OUTCOME:** Kumerian destroyed the auxiliary carrier and hunted down most of the fighters. He was rewarded with promotion to command the D6 battlecruiser *Destruction*. (It was unusual to go from a frigate to a cruiser command without first being XO of the cruiser. In Kumerian's case, this appears to have been done to inspire the crew with their new "hero" leader.) Kumerian went on to have a colorful career and died nearly two decades later as an admiral in command of a dreadnought.

**END OF (SH0.0) BASIC SET**

# (SM0.0) MONSTER SCENARIOS

When a live opponent is not available, you can play one of these solitaire monster scenarios. The monster moves by automatic rules; your challenge is to anticipate his movements and position your ship to deal with the threat most effectively. (Some monsters in other products are designed to be controlled by a player.)

These scenarios are also an excellent training course, allowing you to learn how to handle your ship in combat (without the pressure of a human opponent demanding that you "hurry up and move"). They are designed to allow full use of all systems and to encourage you to learn what everything on your ship (tractors, transporters, weapons, shields, etc.) is there for.

These scenarios are self-adjusting for the ship used, and players can further adjust them for their own skill levels. By all means, if you have killed a given monster so often as to be bored with him, increase the number of points required or use a smaller ship.

**NOTE:** Some systems do not work against some types of monsters. See erratic maneuvering (C10.43), electronic warfare (D6.397), cloaks (G13.53), enveloping plasma torpedoes (FP5.36), and tractors (G7.29). Many monsters use the close-in defense system (E6.0). Several monster rules are found in (S6.0). When fighting monsters and BPV is to be used for any reason, always use combat BPV unless the scenario instructions say otherwise.

## (SM1.0) THE PLANET CRUSHER (The Creature that ate Sheboygan III)

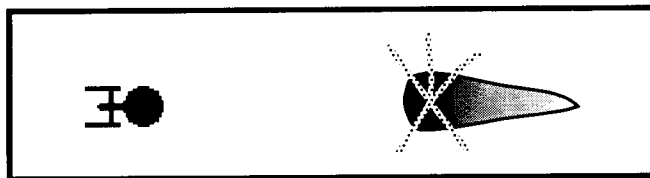

by Stephen V. Cole, Texas

From a distant corner of the galaxy comes word that some "thing" is destroying entire planets. It is the size of several large ships and seems to be either a living thing or perhaps some massive ship sent on a raid by one of the hostile races.

**(SM1.1) NUMBER OF PLAYERS:** 1; The monster moves by automatic rules; see (SM1.44-47).

### (SM1.2) INITIAL SET UP

**TERRAIN:** The Planet Sheboygan-III (Class M) is in hex 2502.

**MONSTER:** The Planet Crusher in hex 0230.

**SHIP(S):** One or more ships in any or all of hexes 4214, 4215, 4216, or 4217. Heading at the option of the player, speed max, WS-1.

**YEAR:** Players must select a year for the scenario as this will define available ships, refits, fighters, weapons, etc. Y172 is assumed if no alternative selection is made.

**(SM1.3) LENGTH OF SCENARIO:** The scenario continues until either the monster has destroyed the planet or the starship(s) have destroyed the monster.

### (SM1.4) SPECIAL RULES

**(SM1.41) MAP:** Use a floating map.

**(SM1.42) SHUTTLES AND PFs:** There are no PFs, fighters, or multi-role shuttles in this scenario, and this rule can be ignored. If playing this scenario using rules and components from other products (or the Kzinti CV), the player might choose to use these items. See (S1.3).

**(SM1.43) COMMANDER'S OPTION ITEMS:** Players should ignore this section [but not (SM1.432) below] when first playing the scenario, but might want to use it after gaining experience in the game.

**(SM1.431)** The ship can purchase additional equipment as Commander's Option Items; see (S1.3). Note that whatever is spent here counts in (SM1.7) as part of the BPV of the ship.

**(SM1.432)** All drones are "medium," speed-20.

**(SM1.44)** The monster moves by special automatic rules. As its "mission" is to destroy the planet, the monster will always move (unless distracted by the ships) toward the planet. In cases where the monster may move into either of two hexes (both of which are "toward" the planet), the player may roll a die (odd numbers going left and even numbers going right), toss a coin, or alternate. The monster has a speed of 6 hexes per turn. The monster has a turn mode of "0;" it can move in any direction regardless of prior movement.

**(SM1.441)** If, during the Movement Step of any impulse, a starship is at a range two hexes or less from the monster, the monster will pursue (F2.0) the starship. If two or more starships are within this "detection" range, the monster will follow the closer one. If two are at the same range, the monster will follow the larger one. If both are the same size, decide by die roll or continue following the one most recently followed. The Planet Crusher is not distracted by fighters, shuttles, or PFs; it will not follow them. If the monster enters the same hex as a ship it will stay in that hex as until the ship is destroyed or leaves.

**(SM1.442)** If the monster moves adjacent to the planet, it will cease movement, unless it moves to follow a starship.

**(SM1.45)** Due to strong electro-magnetic interference, the monster cannot be fired at from a true range of more than 6 hexes. Drones and seeking shuttles more than 6 hexes from the monster will not accept it as a target. (A scatter-pack could be sent toward the monster on a ballistic course set to release "randomly targeted" drones at a range of 6 or less.) Certain drones (FD5.252) could be launched from more than 6 hexes and lock-onto the monster when they get to that range.

**(SM1.46)** The monster can be held in a tractor beam. It has 10 points of negative tractor. If tractorred, its pseudo-speed (G7.36) is not reduced; it has a towing cost of 12.

**(SM1.47)** The monster is equipped with the close-in defense system (E6.0), giving it considerable protection from seeking weapons.

**(SM1.48)** On the first impulse that the monster "detects" (is within 6 hexes of) a starship, it will fire its "weapon." This operates as a phaser, but uses the special chart below:

Die roll	1	2	3	4	5	6
Damage	35	30	25	20	15	10

Range has no effect on the result, but the weapon is limited to a range of 6 hexes. The weapon has a 360° field of fire. If the monster is within range of the planet, it will fire at the planet. The die roll is not affected by EW (D6.3) or atmosphere (P2.541). The monster can fire its weapon only once per turn at the planet and once per turn at the ship (if in range). Exception: If there is more than one ship in the scenario, the monster can fire once per turn at each ship.

**(SM1.5) VICTORY CONDITIONS:** The monster wins if it can inflict 200 points of damage on the planet. The player wins if he can inflict 200 points of damage on the monster (at which point the monster is destroyed). See (SM1.7). The player may, at his option, use the victory conditions from (S6.1) in this section. Gather 200 points of info and roll. (Beginning players should start with a monster that can be destroyed by 100 damage points and increase this by 25 points every time they win with a given ship.)

**(SM1.6) ORDER OF BATTLE VARIATIONS:** Players should feel free to use any ships or combinations of ships in this scenario. The objective is, over a number of playings, to be able to stop the monster with ANY of the ships given in the game. (After all, no one ever knows what ship will be available if needed, and the best captains can use any class of ship to its best advantage.) See (SM1.7).

**(SM1.7) SHIP SIZE ADJUSTMENTS:** Whenever playing this scenario, and especially when using it as part of the Captain's Game (U2.0), the strength of the monster is adjusted to the ship used by the player by the following equation:

$$N = \frac{V}{125} \times 200$$

where N is the number of points that must be scored on the monster to destroy it and V is the BPV of the ship. Drop all fractions.

**(SM1.8) TACTICS:** This is the simplest monster of all. Virtually all ship functions are available, and you already know how to destroy the monster (with 200 damage points) unless you are using (S6.1).

The ship starts off 30 hexes from the Planet Crusher. You should get within 10 hexes of it the next turn. You do not need to power shields on the first turn since the Planet Crusher cannot fire beyond 6 hexes. Active fire control also does not need to be powered unless you have drones to launch (and get close enough). Probes should not be powered unless and until the ship is crippled. (Put all of the extra power into overloads.) Shuttles should be utilized as fire platforms, suicide shuttles, or scatter-packs. WWs are unnecessary since no seeking weapons can be launched at you.

On Turn #2, close with the monster. At 6 hexes, it will fire its anti-proton beam. Depending on the roll, the facing shield could collapse. (Naturally, give it a shot at the #2 or #6 shield, not #1. You will have to risk all three front shields to get in three attack runs.) Calculate how much reinforcement is necessary to prevent penetration. (You may have to risk a monster weapon die roll of 1 or 2 after your shields have taken some damage.) You then approach the monster for an all-out attack. (You might launch a suicide or scatter-pack shuttle.) Concentrate your seeking weapons to overwhelm the MCIDS. Fire all phasers and heavy weapons at point blank range for maximum effort (i.e., an Alpha Strike). Launch seeking weapons from zero-hex range to avoid having MCIDS destroy them all.

Since the monster is much larger than the ship, you can sow the area with T-bombs set for his size class. These will ignore your size-3 cruiser, but add more damage to the size-1 monster.

The Planet Crusher has no shields, so you don't have to maneuver to hit a down shield. As there is only one "system" (and it takes 200 points to destroy), there is no need for multiple attacks to score the "one-time" hits on the DAC (known as the Mizia Concept). Be sure that your attack run takes the ship away from the planet so you will gain time when the monster follows you.

If you have Advanced Missions, you can use (C12.0) speed changes to stay within two hexes of the monster for the middle part of the turn, but accelerate so that you will be outside of six hexes by the start of the next turn (when he can fire again).

If the front shield has gone down, don't panic! The monster is still moving slowly, and his maneuvers are entirely predictable. During the reload turn, use damage control to patch up any damaged systems. Fire phasers. Continue making a pass whenever your overloads or plasma torpedoes are ready.

As each pass may cost you a shield, three of them could eliminate your forward shields. If this happens, overrun in reverse (taking his weapons fire on your rear shields and then firing your weapons as they clear). Eventually, the Planet Crusher will go down.—Frank Crull (from the *Star Fleet Battles Tactics Manual*)

## (SM2.0) THE SPACE AMOEBEA

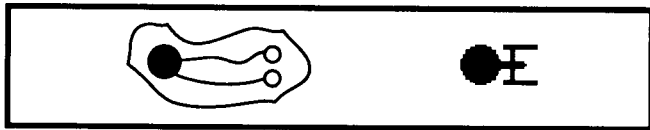

by Stephen V. Cole, Texas

Patrolling ships report an unknown being moving in a nearby sector, and a cruiser is sent to investigate. Upon locating the alien, the cruiser determines that it is harmful and must be destroyed. However, neither the ship's veteran science crew, nor the computers, can determine what will destroy the monster. The captain orders his ship in closer to investigate and prays it will turn out to be friendly.

**(SM2.1) NUMBER OF PLAYERS:** 1; The monster moves by automatic rules; see (SM2.44).

### (SM2.2) INITIAL SET UP

**MONSTER:** The Space Amoeba is placed in hex 2115.

**SHIP:** A single starship enters the map from any map edge, facing the monster, speed 10, WS-III.

**YEAR:** Players must select a year for the scenario as this will define available ships, refits, fighters, weapons, etc. Y172 is assumed if no alternative selection is made.

**(SM2.3) LENGTH OF SCENARIO:** The scenario continues until the monster has been destroyed or the starship has been destroyed or has disengaged.

### (SM2.4) SPECIAL RULES

**(SM2.41) MAP:** Use a floating map.

**(SM2.42) SHUTTLES AND PFs:** There are no PFs, fighters, or multi-role shuttles in this scenario, and this rule can be ignored. If playing this scenario using rules and components from other products (or the Kzinti CV), the player might choose to use these items. See (S1.3).

**(SM2.43) COMMANDER'S OPTION ITEMS:** Players should ignore this section [but not (SM2.432) below] when first playing the scenario, but might want to use it after gaining experience in the game.

**(SM2.431)** The ship can purchase additional equipment as Commander's Option Items; see (S1.3). Note that whatever is spent here counts in (SM2.7) as part of the BPV of the ship.

**(SM2.432)** All drones are "medium," speed-20.

**(SM2.44)** The monster moves with a speed of 4 in a totally random pattern. During each impulse that monster is to move, roll a single die and move the monster in that direction according to the numbered directional display printed in the lower left-hand corner of the map.

**(SM2.45)** The starship may fire weapons at the monster, recording the cumulative amount of damage scored for possible use later.

**(SM2.46)** The primary operation in this scenario is the scientific investigation of the monster. Refer to the lab rules (G4.1) for instructions in gathering information. If you have Advanced Missions, see (FD6.0) probe drones and (G24.27) special sensors.

At the end of each turn, the player must determine how much information he has gained about the monster and how much damage the monster has done to his ship. This is determined using the chart (G4.1). Scientific shuttles (J2.21) and probes (G5.0) may assist in obtaining information. The number from the (G4.1) chart, multiplied by two, is the number of damage points scored on the ship (actually on the facing shield) by the monster. The facing shield is the one that was facing the monster on the first impulse of closest approach. Due to the special nature of the damage, shield reinforcement is ineffective (i.e., ignored).

Shuttlecraft sustain one point of damage at the end of any turn during which they were (at any time) within 10 hexes of the monster; they do not receive damage based on the chart as ships would.

**(SM2.47)** The monster cannot be held in a tractor beam (G7.29); exception (S6.1) Result #2. The monster has MCIDS (E6.0).

**(SM2.48)** At the end of Turn #20, the monster divides into two entities. All lab points are lost, and new points must be accumulated against each monster separately. One lab cannot accumulate points against two monsters on the same impulse. Each thereafter moves independently, and they will not enter the same hex if there is a legal alternative.

**(SM2.5) VICTORY CONDITIONS:** The monster wins if the starship is destroyed or disengages (in the campaign game, a disengaged ship, after repairing, would return to find two such monsters, the original having divided). The player wins if he can accumulate 400 points of scientific information. Use this information to determine just what will destroy the monster, and then destroy the monster. Once he has accumulated the required points, roll one die and consult the table in (S6.1). See (SM2.7).

**(SM2.6) ORDER OF BATTLE VARIATIONS:** As in scenario (SM1.0), the players are encouraged to use all classes of ships in this scenario, the object being to be able to destroy the monster with any ship. See (SM2.7).

**(SM2.7) SHIP SIZE ADJUSTMENTS:** Whenever playing this scenario, and especially when using it as part of the Captain's Game (U2.0), the strength of the monster is adjusted to the ship used by the player by the following equation:

$$N = \frac{V}{125} \times 400$$

where N is the number of points of information that must be accumulated in order to determine what will kill the monster and V is the BPV of the ship being used. Drop all fractions.

**(SM2.8) TACTICS:** This monster does damage based upon how close the player gets to it, a sadistic twist on the lab rules.

You must accumulate scientific data, and that means getting close to the "mystery monster." Solution #3 requires you to accumulate 200 points of damage; however, Solution #6 says that if you scored more than 50 points you could lose. So during the initial phases, leave the heavy weapons unpowered, score 50 points (no more!) with phasers, and wait for the die roll.

Your shuttles can prove invaluable. (A Klingon ship, with few labs, could actually gather more info with shuttles.) As these shuttles will take one point of damage per turn, they can function for several turns before you need to repair them. A Federation ship, with plenty of labs, could keep one suicide shuttle "warmed up" in the bay to save time later. The shuttles should operate 4 hexes from the monster, outside of MCIDS range, but close enough to gather an average of 3.5 points of information per turn.

Probes can also be used to gain information although the last two or three should be saved for use if Solution #4 presents itself. Probe drones can be of particular value as can sensor channels. (Survey ships, found in some advanced products, can wrap up a monster of this type before breakfast.) If using the Commander's Options (S3.2), consider buying extra probes to gain information and deck crews to repair shuttles. This will, however, make winning much easier than the minor increase in BPV (SM2.7) will reflect.

The basic tactic is to get as close to the monster as you dare (no need for in-and-out tactics here since time-at-range doesn't increase casualties) and wait until you learn how to kill it. Upon determining this, exercise that option immediately to minimize further damage to your ship.—*Frank Crull (from the Star Fleet Battles Tactics Manual)*

**(SM3.0) THE MORAY EEL OF SPACE**

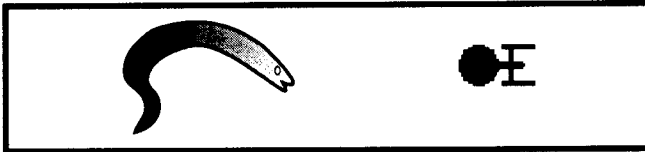

by Stephen V. Cole, Texas

The terror of the depths of space! A creature half a kilometer long, living in hard vacuum and eating ships for breakfast (literally) is reported in a remote sector. A starship is sent to destroy it.

**(SM3.1) NUMBER OF PLAYERS:** 1; The monster moves by automatic rules; see (SM3.44-45).

**(SM3.2) INITIAL SET UP**

**PLANET:** There is a class-M planet 100 hexes in direction A from hex 2201. The monster is moving toward this planet and will destroy the colony there if it can.

**MONSTER:** The Moray Eel of Space is in hex 2215.

**SHIP:** A single starship enters the map from any map edge, facing the monster, speed 10, WS-I.

**YEAR:** Players must select a year for the scenario as this will define available ships, refits, fighters, weapons, etc. Y172 is assumed if no alternative selection is made.

**(SM3.3) LENGTH OF SCENARIO:** The scenario continues until the monster has been destroyed or the starship has been destroyed or has disengaged.

**(SM3.4) SPECIAL RULES**

**(SM3.41) MAP:** Use a floating map.

**(SM3.42) SHUTTLES AND PFs:** There are no PFs, fighters, or multi-role shuttles in this scenario, and this rule can be ignored. If playing this scenario using rules and components from other products (or the Kzinti CV), the player might choose to use these items. See (S1.3).

**(SM3.43) COMMANDER'S OPTION ITEMS:** Players should ignore this section [but not (SM3.432) below] when first playing the scenario, but might want to use it after gaining experience in the game.

**(SM3.431)** The ship can purchase additional equipment as Commander's Option Items; see (S1.3). Note that whatever is spent here counts in (SM3.7) as part of the BPV of the ship.

**(SM3.432)** All drones are "medium," speed=20.

**(SM3.44)** The monster has a speed of 12 and a turn mode of 0. It will move in direction A unless it moves to attack the ship. If the monster is not on the 22xx hex row, it will sideslip toward that row while continuing to move in direction A. If the monster is in direction A from the planet, reverse this and the monster moves in direction D.

**(SM3.45)** The monster will respond to any attack by the ship. If struck by direct-fire weapons, the monster will, on the next impulse, move immediately to the hex of the unit (up to six hexes in a burst of speed in a single impulse; this violates the normal speed limits) and attack that ship by "biting" (SM3.46). The monster then resumes his normal movement (SM3.44) on the next impulse (unless attacked again). If there is more than one firing unit, the monster will attack all of them (in a "biting frenzy" during the same impulse, in a random order). If the unit that attacked the Eel is destroyed as a result of its attack (such as a Swordfish drone) the monster will not attack that unit.

**(SM3.46)** The monster attacks the ship by "biting" (with plasma tipped teeth) when it is in the same hex as the ship. The effect of the "bite" is shown on the table below:

DIE ROLL	1	2	3	4	5	6
DAMAGE	10	9	8	7	6	5

The damage is scored directly on the ship; shields are ignored. The monster can attack any given target only once per impulse but could attack a different target each impulse. If the monster bites a shuttle (even a large one), add 4 points of damage. The Moray Eel's bite is resolved during the Movement Segment as a non-plasma seeking weapon (6A3).

**(SM3.47)** The Moray Eel of Space cannot be held or towed by a tractor beam [exception: (S6.1) Item #2]. The Moray Eel has a close-in defense system (E6.0).

**(SM3.48)** Because of the maneuverability of the monster, the weapons of the ship cannot hit it if fired from beyond 6 hexes. Seeking weapons will not accept the monster as a target if launched from beyond 6 hexes. A scatter-pack could be sent toward the monster on a ballistic course set to release "randomly targeted" drones at a range of six or less. Certain drones (FD5.252) could be launched from more than 6 hexes and lock-onto the monster when they get to that range. Shuttles (other than EWFs, MRS, or SWAC) cannot control drones targeted on the monster due to his powerful jamming.

**(SM3.5) VICTORY CONDITIONS:** The monster is destroyed when it has received an unknown number of damage points. After scoring 200 points of damage, the starship player rolls a die. If the result is "1," the monster has been destroyed. If not, the starship player may roll the die again at the end of any impulse in which at least 10 additional points of damage are scored (NOT once for each 10 points, once on each impulse when at least 10 points are scored). If the die roll is a "1," the monster is destroyed. See (SM3.7).

Alternatively, use (S6.1) and accumulate 200 information points. If the monster reaches the planet, the player loses immediately.

**(SM3.6) VARIATIONS:** As in other "monster" scenarios, the player may use any starship. Two starships will produce a dramatically different scenario dynamic (as each can alternate to provoke the monster, accepting less damage). See (SM3.7).

**NOTE:** This monster can be easily defeated by fighter squadrons and PF flotillas. Do not use those systems against this monster. (There is no point in doing so. Just say you won and go on.)

**(SM3.7) SHIP SIZE ADJUSTMENTS:** Whenever playing this scenario, and especially when using it as part of the Captain's Game (U2.0), the strength of the monster is adjusted to the ship used by the player by the following equations:

$$N = \frac{V}{125} \times 200 \quad I = \frac{V}{125} \times 10$$

where N is the number of points of damage that must be scored on the monster before the die rolls can begin, I is the number of damage points that must be accumulated for each additional die roll, and V is the BPV of the ship being used. Drop all fractions.

**(SM3.8) TACTICS:** The Eel moves at speed 12. You can "lead" him to some extent, but only by encouraging him to attack your ship. This creates a difficult choice. If you fire all of your weapons in a single volley, you can only get him to move six hexes (half of his movement, presumably away from the planet) in a single turn. If you fire several volleys during the turn, you can force the monster to move farther from the planet. Unfortunately, your ship will take damage from the monster every time you "provoke" him. You can even "poke" the monster with one phaser to encourage him to come into your hex (where you have a full alpha-strike with overloaded weapons waiting). While it may appear that shields are useless, you will need them to absorb feedback damage from firing your weapons at zero range.

On the first turn, arm weapons and move toward the monster. On the second turn, move to 1 hex *behind* him and do an emergency deceleration. Give him the full alpha strike and accept his bite. Then, on the next turn, switch into reverse and back away. At range 6, give him whatever weapons are available (overloaded disruptors on a Klingon D7, only phasers on a Fed CA) and draw him back again (accepting another bite but gaining time by luring him away from the planet). Then reload your heavy weapons and repeat the process.

Drones and suicide shuttles are useful as they do not provoke the monster, but they will have difficulty penetrating the defense system (E6.0). You can pull out of range and repair damage if you need to. Pay close attention to the repair procedures in (D9.7). If you have Advanced Missions, see (D14.0) for additional repair options.

The problem begins when you have scored the 200 points and have to begin rolling a die on any impulse that you score 10 points of damage. This requires your ship to stay within 6 hexes range for extended periods to get multiple opportunities, and you will be bitten repeatedly. Reasonable skill can give you enough opportunities to fire to eventually get a destruction result (if your ship survives that long).—*Frank Crull (adapted from the Star Fleet Battles Tactics Manual, additional material added by Steven P Petrick)*

**(SM3.9) NOTES:** Veteran players of SFB will find that this monster is now much more dangerous than before. The original version of this scenario allowed the monster to be led around passively.

**(SM4.0) THE COSMIC CLOUD**

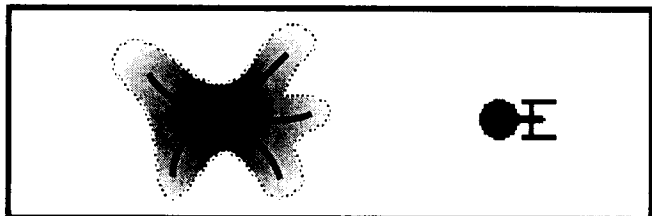

by Stephen V. Cole, Texas

An unknown entity is destroying shipping in the Sigma Draconis Sector. The Fleet responds by sending a starship. Weeks later, it is found floating in space, the entire crew dead from unknown causes. Another starship is sent to investigate.

**(SM4.1) NUMBER OF PLAYERS:** 1; The monster moves by automatic rules; see (SM4.44).

**(SM4.2) INITIAL SET UP**

**MONSTER:** The Cosmic Cloud is placed in hex 2215.

**SHIP:** A single starship enters the map from any map edge, facing the monster, speed 10, WS-1.

**YEAR:** Players must select a year for the scenario, as this will define available ships, refits, fighters, weapons, etc. Y172 is assumed if no alternative selection is made.

**(SM4.3) LENGTH OF SCENARIO:** The scenario continues until the monster has been destroyed or the starship's crew have all been killed or the starship has disengaged.

**(SM4.4) SPECIAL RULES**

**(SM4.41) MAP:** Use a floating map.

**(SM4.42) SHUTTLES AND PFs:** There are no PFs, fighters, or multi-role shuttles in this scenario, and this rule can be ignored. If playing

this scenario using rules and components from other products (or the Kzinti CV), the player might choose to use these items. See (S1.3).

**(SM4.43) COMMANDER'S OPTION ITEMS:** Players should ignore this section [but not (SM4.432) below] when first playing the scenario, but might want to use it after gaining experience in the game.

**(SM4.431)** The ship can purchase additional equipment as Commander's Option Items; see (S1.3). Note that whatever is spent here counts in (SM4.7) as part of the BPV of the ship.

**(SM4.432)** All drones are "medium," speed=20.

**(SM4.44)** The monster moves with a speed of 4 in a totally random pattern. During each impulse that the monster is to move, roll a single die and move the monster in that direction according to the numbered directional display printed in the lower left-hand corner of the map.

**(SM4.45)** The monster produces a field that has the effect of killing crew units; the exact cause is unknown. At the end of each turn, the chart below is used to determine how many crew units have been killed. The range given is the closest approach of the ship to the monster during the turn just ending. If the shields are not operating at full power, losses are doubled. In an exception to (G9.22), the monster can kill the entire crew. (Note: The crewmen are not actually killed, but are drained of living energy. If the ship does not leave the scenario, the unconscious crewmen will die after a few more turns.) Note the minimum crew requirements in (G9.4). If a manned shuttle is drained of living energy, the shuttle stops moving.

DIE ROLL	RANGE					
	0	1	2	3-5	6-10	11+
1	4	4	4	3	2	0
2	4	3	3	3	1	0
3	3	3	3	2	0	0
4	3	3	2	1	0	0
5	2	2	1	0	0	0
6	1	1	1	0	0	0

**(SM4.46)** The starship may fire weapons at the monster, recording the cumulative amount of damage scored for possible use later.

**(SM4.47)** The ship uses the lab rules (G4.1) to accumulate information about the monster.

**(SM4.48)** The monster cannot be held in a tractor beam (G7.29); exception (S6.1) Result #2.

**(SM4.49)** The monster has MCIDS (E6.0).

**(SM4.5) VICTORY CONDITIONS:** The monster wins if the starship disengages or the crew is all killed. The player wins if he can accumulate 400 points of scientific information, use this information to determine just what will destroy the monster, and then destroy the monster. After accumulating the required points, roll one die and consult the table in (S6.1). See (SM4.7).

**(SM4.6) VARIATIONS:** As in other "monster" scenarios, the player may use any starship. Do not use a legendary doctor (G22.6) as this would produce an almost automatic victory. See (SM4.7).

**(SM4.7) SHIP SIZE ADJUSTMENTS:** Whenever playing this scenario, and especially when using it as part of the Captain's Game (U2.0), the strength of the monster is adjusted to the ship used by the player by the following equation:

$$N = \frac{V}{125} \times 400$$

where N is the number of points of information that must be accumulated in order to determine what will kill the monster and V is the BPV of the ship being used. Drop all fractions.

**(SM4.8) TACTICS:** The tactics for dealing with this monster are similar to those used in (SM2.8). The Cosmic Cloud, however, has a subtle twist. Here, your ship will not be damaged but you will run out of crew units (G9.4). Calculate the benefit of a closer range for the labs against the cost of more casualties.

**END OF SECTION (SM0.0) BASIC SET**

**(T0.0) MINI-CAMPAIGNS**

**(T1.0) GENERAL RULES**

Mini-campaigns are relatively short series of scenarios (up to six) representing some small campaign within a larger war. Mini-campaigns are usually, but not always, fought in such rapid succession that repairs are not always possible between scenarios.

Many scenarios require the players to select races based on geography or political alignment. A more complete map (than that on page #6) of the known regions of the galaxy is provided below.

Notes on political alignment in Y168 (on the eve of the General War):

**FEDERATION:** Constant tension with Klingons and Romulans; alliance with Gorns; treaty with Kzintis with whom they have fought wars in the past.

**KLINGONS:** Constant warfare with Hydrans and Kzintis; constant tension with Federation; constantly raiding Tholians to maintain pressure for eventual reconquest of that area; allied to Lyrans but have fought wars with them in the past; relatively stable relations with the LDR with whom they have had a minor border clash; occasional raids on WYN Cluster to test Cluster defenses, but major operations stymied by support the Cluster receives from the Kzinti, Lyrans, and Orion Pirates.

**ROMULANS:** Constant tension with Federation and ISC; constant warfare with Gorns; rare fighting with Tholians. Allied to Klingons.

**KZINTIS:** Constant warfare with Lyrans and Klingons, allied to Federation but have fought several wars with them; occasional outbreaks of internal disorder/Civil War; would like to see to extermination of WYN Cluster due to existence of a false claimant to the Patriarchal throne, but frustrated by support the Cluster receives from the Lyrans, Klingons, and Orion Pirates.

**GORNS:** Constant warfare with Romulans; allied to Federation but have fought a short war with them; constant tension with ISC.

**THOLIANS:** Constant harassment by Klingons; rare attacks by Romulans; border violations by Federation; prior to the General War, the Tholian general policy was aimed at playing neighboring races off against each other with no firm commitments of Tholian resources; in late General War years became a Federation ally.

**ORIONS:** Pirates operating in many areas. Divided into several cartels, each cartel operating in the territory of at least two races. Orion warships are (albeit rarely) available for hire as mercenaries, but Cluster Cartel and other independent Orion ships frequently assist the WYN Cluster in retaining its autonomy in order to use it as a base.

**HYDRANS:** Constant warfare with Lyrans and Klingons; relatively stable border and trade with the LDR with whom they have fought a minor border war. Module C1.

**LYRANS:** Constant warfare with Kzintis and Hydrans; allied to Klingons but have fought wars with them in the past; frequent attempts to subvert LDR and reintegrate it into the empire; frequent Civil Wars and internal disorder; occasional raids on WYN Cluster, but major operations curtailed by support the Cluster receives from Kzinti, Klingons, and Orion Pirates. Module C1.

**ANDROMEDANS:** An invading power from another Galaxy; not allied with any race, but may attempt to negotiate treaties with any race to enable them to attack another race with impunity. Module C2.

**WYN:** A strictly neutral power at the conjunction of the Klingon, Lyran, and Kzinti borders; occasionally raided by surrounding powers; claims to have legitimate heir to Kzinti Hegemony throne; watchful relations with Cluster Cartel Orion Pirates who maintain an operating base within the Cluster. Module C1.

**ISC:** The ISC had contacted the Gorns and Romulans before the General War, but made no effort to open relations (feeling that both races were repugnantly violent). The ISC solidified their borders and remained neutral during the General War. Module C2.

**LDR:** Neutral state bordering on the Klingon, Lyran, and Hydran borders; has fought at least one minor war with both the Hydrans and Klingons separately; attempts to export "revolution" to the rest of the Lyran Empire and has clashed with the Empire or elements thereof at least twice. Module C3.

If the players wish to conduct a war between two non-adjacent races, or between two allies, purely for the purpose of analyzing the various tactical implications, they should not hesitate to do so. Conflicts may be set in any time period, but care must be taken to avoid mismatches in available technology, e.g., LDR CWs versus Kzinti CLs with slow drones.

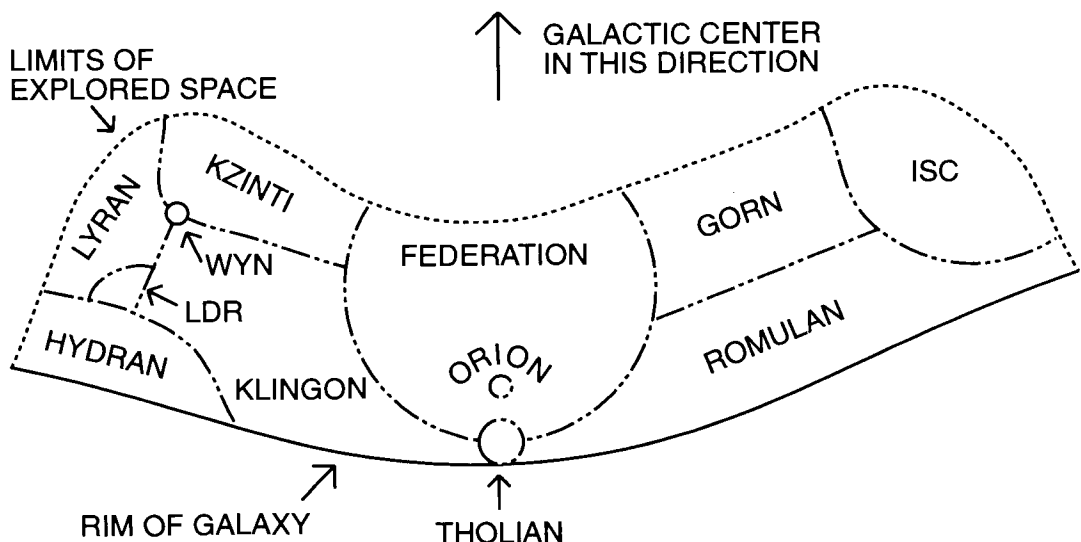

**(T2.0) ECONOMY OF FORCE**

**Y Varies** by Stephen V. Cole, Texas

This is a multi-scenario campaign game. It represents a series of more or less simultaneous actions fought along a stretch of a frontier.

This is an excellent campaign for a gaming group, with six players on each side playing the six scenarios simultaneously.

**(T2.1) CAMPAIGN ORGANIZATION**

**(T2.11) SET UP:** The campaign uses two players of adjacent but unfriendly races.

The following races cannot be used:

- WYN (Module C1, they seldom leave the Cluster),
- Andromedan (Module C2, they have no on-map territory),
- Orion (being pirates, they have no territory to defend).

There will be a total of six scenarios, each representing a battle being fought more or less simultaneously. Ships that are used in one scenario can not be used in another scenario [exception; (T2.4)].

**(T2.12) FLEET SELECTION:** Each player selects a force of ships from his Master Ship Chart, to a maximum of 1,000 points (or more, depending on year) of combat BPV [except that any scouts are purchased based on their economic BPV (G24.35)]. Any unused points count as victory points in the final totals. These points include ships, drone speed upgrades, refits, and fighters only; Commander's Option Items are in (T2.16) below.

**(T2.121)** Players should select a year for their campaign. This year will determine available ships, fighters, PFs, drone speeds, etc. See the chart below:

YEAR	BASE	FTRS	PFs	DRONES	FLEET
Y160	BS	No	No	Slow	1,000
Y168	BATS+2xHBM	Yes	No	Medium	1,250
Y175	BATS+2xHBM	Yes	No	Medium	1,333
Y182	BATS+2xH+PF	Yes	Yes	Fast	1,500

If the players agree before the campaign begins, they can buy modules (found in other products) to replace the modules listed here. They must tell each other what modules they are using instead (intelligence will provide this information to each side usually), unless both agree to keep this information secret. Replaced modules can be turned in for their BPV value to reduce the cost of replacement modules, but no modules will be simply "floating in space" beside the stations.

**(T2.122)** Monitors and minelayers cannot be used. X-ships cannot be used unless both sides agree to their use. Tholians cannot use more than one Neo-Tholian ship. No ship modifications (S7.0) are allowed. Bases cannot be used except as provided in (T2.14).

**(T2.123)** It is suggested that you do not use fighters or carriers unless you have Module J or Advanced Missions. Carriers must have the escorts listed in their ship descriptions. See (T2.15) concerning fighter deployment. Fighters must be of a type appropriate to the carrier; see carrier description. Fighters can be used under the following circumstances, and only under these circumstances:

**(T2.1231)** The base has two fighter modules (Y168 or later) and a squadron of 12 fighters (class 2 in Y168, class 3 in later years). These fighters are used as a unit (all 12 must be in the same scenario) but can be in any scenario (except as noted).

**(T2.1232)** If a carrier is purchased, it can have the fighters provided in its ship description. These fighters do not have to be used in the same scenario as their carrier, but all must be together as a squadron.

**(T2.124)** Fast patrol ships (Module K) can be used as follows (and only under the circumstances given):

**(T2.1241)** The base has one PF module (Y182 only) and one PF flotilla (including a leader and scout). These are used as a unit (all of them in one scenario) but can be in any scenario (except as noted). The Federation uses A-20 fighters instead of PFs.

**(T2.1242)** If a PFT is purchased, it can have a complete flotilla (including a leader and scout). These are used as a unit but do not have to be in the same scenario as their PFT.

**(T2.1243)** If ships in the fleet are given mech links (R1.R3), they can have PFs (no leaders or scouts). These PFs can be used in

any scenario and do not have to be in the same scenario as the ship that has the mech link.

**(T2.125)** When players purchase their ships, they can (and in some cases must) purchase whatever refits are available and appropriate to those ships in that year.

**(T2.13) BATTLE FORCE SELECTION:** Each player secretly divides his ships into six numbered groups. At least one ship (a fighter squadron or PF flotilla can substitute for the ship) must be assigned to each group. Each group must be within the appropriate command limits (S8.2). The players will then play the six scenarios, each with the two correspondingly numbered groups.

**(T2.14) BATTLE STATIONS:** Player #1 has a battle station in his #1 group, while player #2 has a battle station in his #6 group. The battle stations do not count against the 1,000-point total, but do count for figuring victory. Note that in Y160 this is a base station. Modules are specified in (T2.121); any empty module positions have cargo modules.

**(T2.15) INDEPENDENT FIGHTERS AND PFs:** Fighters and PFs from the base cannot be used independently of a carrier or tender except by player #1 in scenario #2 and by player #2 in scenario #5. PFs from the base can be used by both players in scenarios #3 and #4. Fighters from carriers must be in a scenario adjacent to their carrier; PFs must be within two scenarios of their PFT (i.e., PFT in scenario #3, PFs cannot be in scenario #6).

**(T2.16) COMMANDER'S OPTION ITEMS:** Each ship can purchase Commander's Option Items (S3.2) equal to 20% of its BPV. This can include special drones, extra fighter equipment, T-bombs, extra drones; extra marines, or deck crews; MRS shuttles on qualified ships; etc. Note that the year selected may make some equipment unavailable.

**(T2.2) SCENARIOS**

The six scenarios are (T2S1.0) through (T2S6.0). These are listed below. Set up six maps and set up the units for each side of all six scenarios. The six battles are fought simultaneously.

If either player in any scenario feels he is outnumbered, he can withdraw from that scenario. If he does so, the forces so committed cannot be used in the campaign (unless there is a subsequent round). The other player then collects the points for winning that scenario (T2.3) and can transfer his ships to either adjacent scenario (or some to each). After any such transfer, the withdrawal options may be exercised again. When no one else wants to withdraw, the scenarios are played.

The player whose forces do not withdraw is awarded the appropriate points under (S2.21) for forcing an enemy ship(s) to disengage. The disengaged ships are not destroyed, but are available to be deployed in a subsequent round.

**(T2.3) CAMPAIGN VICTORY CONDITIONS**

Use the Standard Victory Conditions (S2.2) for each scenario, totaling the points scored in each of the six scenarios and adding ten bonus points to each player for each scenario he won (based on the points scored in that scenario). The aggregate total will reveal the winner of the campaign.

**(T2.4) EXTENDED CAMPAIGN**

After playing the six scenarios, add replacements and reinforcements and repeat the campaign. Each player can buy 250 points of new units at the end of the campaign; all shuttles and ammunition (drones, ADDs) are replaced.

**(T2.5) BALANCE**

The campaign can be balanced between players or teams of different levels of skill by allowing one player/team additional points, or reducing the points available to one player/team, with which to purchase their forces.



**(T2S0.0) CAMPAIGN SCENARIOS**

**(T2S1.0) PLAYER #1'S BASE**

This scenario takes place at player #1's battle station.

**(T2S1.1) NUMBER OF PLAYERS:** 2; player #1 and player #2.

**(T2S1.2) INITIAL SET-UP**

**PLAYER #1:** Battle station in 2215. Ships and other units selected in (T2.13) within 6 hexes of 2215, facing optional, speed 10, WS-III.

**PLAYER #2:** Ships and other units selected in (T2.13). These cannot include independent fighter or PF units. Enter within two hexes of 2201, heading D, speed max, WS-III.

**(T2S1.3) LENGTH OF SCENARIO:** The scenario continues until all forces belonging to one side have been destroyed, captured, or have disengaged.

**(T2S1.4) SPECIAL RULES**

**(T2S1.41) MAP:** Use a floating map. A player cannot disengage his forces in any given scenario until he has scored internal damage on at least one enemy ship or one of his own ships has been crippled.

**(T2S1.42) SHUTTLES AND PFs:** The presence of warp booster packs, MRS shuttles, and/or EW fighters is determined in campaign set up.

**(T2S1.43) COMMANDER'S OPTION ITEMS:** These are defined by (T2.16).

**(T2S1.5) VICTORY CONDITIONS:** Use the Standard Victory Conditions (S2.2).

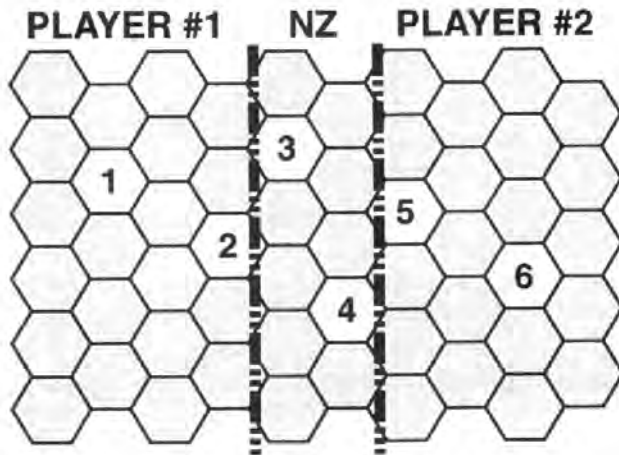

**(T2S2.0) PLAYER #1'S BORDER**

This scenario takes place on the border of player #1's territory and the Neutral Zone.

**(T2S2.1) NUMBER OF PLAYERS:** 2; player #1 and player #2.

**(T2S2.2) INITIAL SET-UP**

**PLAYER #1:** Ships and other units selected in (T2.13). This can include fighters and PFs operating independently. Enter within two hexes of 2230, heading A, speed max, WS-III.

**PLAYER #2:** Ships and other units selected in (T2.13). This cannot include fighters and PFs operating independently. Enter within two hexes of 2201, heading D, speed max, WS-III.

**(T2S2.3) LENGTH OF SCENARIO:** The scenario continues until all forces belonging to one side have been destroyed, captured, or have disengaged.

**(T2S2.4) SPECIAL RULES**

**(T2S2.41) MAP:** Use a floating map. A player cannot disengage his forces in any given scenario until he has scored internal damage on at least one enemy ship or one of his own ships has been crippled.

**(T2S2.42) SHUTTLES AND PFs:** The presence of warp booster packs, MRS shuttles, and/or EW fighters is determined in campaign set up.

**(T2S2.43) COMMANDER'S OPTION ITEMS:** These are defined by (T2.16).

**(T2S2.5) VICTORY CONDITIONS:** Use the Standard Victory Conditions (S2.2).

**(T2S3.0) NEUTRAL ZONE, PLAYER #1 SECTOR**

This scenario takes place in the Neutral Zone, near the border of player #1's territory.

**(T2S3.1) NUMBER OF PLAYERS:** 2; player #1 and player #2.

**(T2S3.2) INITIAL SET-UP**

**PLAYER #1:** Ships and other units selected in (T2.13). This can include PFs but not fighters operating independently. Enter within two hexes of 2230, heading A, speed max, WS-III.

**PLAYER #2:** Ships and other units selected in (T2.13). This can include PFs but not fighters operating independently. Enter within two hexes of 2201, heading D, speed max, WS-III.

**(T2S3.3) LENGTH OF SCENARIO:** The scenario continues until all forces belonging to one side have been destroyed, captured, or have disengaged.

**(T2S3.4) SPECIAL RULES**

**(T2S3.41) MAP:** Use a floating map. A player cannot disengage his forces in any given scenario until he has scored internal damage on at least one enemy ship or one of his own ships has been crippled.

**(T2S3.42) SHUTTLES AND PFs:** The presence of warp booster packs, MRS shuttles, and/or EW fighters is determined in campaign set up.

**(T2S3.43) COMMANDER'S OPTION ITEMS:** These are defined by (T2.16).

**(T2S3.5) VICTORY CONDITIONS:** Use the Standard Victory Conditions (S2.2).

**(T2S4.0) NEUTRAL ZONE, PLAYER #2 SECTOR**

This scenario takes place in the Neutral Zone, near the border of player #2's territory.

**(T2S4.1) NUMBER OF PLAYERS:** 2; player #1 and player #2.

**(T2S4.2) INITIAL SET-UP**

**PLAYER #1:** Ships and other units selected in (T2.13). This can include PFs but not fighters operating independently. Enter within two hexes of 2230, heading A, speed max, WS-III.

**PLAYER #2:** Ships and other units selected in (T2.13). This can include PFs but not fighters operating independently. Enter within two hexes of 2201, heading D, speed max, WS-III.

**(T2S4.3) LENGTH OF SCENARIO:** The scenario continues until all forces belonging to one side have been destroyed, captured, or have disengaged.

**(T2S4.4) SPECIAL RULES**

**(T2S4.41) MAP:** Use a floating map. A player cannot disengage his forces in any given scenario until he has scored internal damage on at least one enemy ship or one of his own ships has been crippled.

**(T2S4.42) SHUTTLES AND PFs:** The presence of warp booster packs, MRS shuttles, and/or EW fighters is determined in campaign set up.

**(T2S4.43) COMMANDER'S OPTION ITEMS:** These are defined by (T2.16).

**(T2S4.5) VICTORY CONDITIONS:** Use the Standard Victory Conditions (S2.2).

**(T2S5.0) PLAYER #2's BORDER**

This scenario takes place on the border of player #2's territory and the Neutral Zone.

**(T2S5.1) NUMBER OF PLAYERS:** 2; player #1 and player #2.

**(T2S5.2) INITIAL SET-UP**

**PLAYER #1:** Ships and other units selected in (T2.13). This cannot include fighters and PFs operating independently. Enter within two hexes of 2230, heading A, speed max, WS-III.

**PLAYER #2:** Ships and other units selected in (T2.13). This can include fighters and PFs operating independently. Enter within two hexes of 2201, heading D, speed max, WS-III.

**(T2S5.3) LENGTH OF SCENARIO:** The scenario continues until all forces belonging to one side have been destroyed, captured, or have disengaged.

**(T2S5.4) SPECIAL RULES**

**(T2S5.41) MAP:** Use a floating map. A player cannot disengage his forces in any given scenario until he has scored internal damage on at least one enemy ship or one of his own ships has been crippled.

**(T2S5.42) SHUTTLES AND PFs:** The presence of warp booster packs, MRS shuttles, and/or EW fighters is determined in campaign set up.

**(T2S5.43) COMMANDER'S OPTION ITEMS:** These are defined by (T2.16).

**(T2S5.5) VICTORY CONDITIONS:** Use the Standard Victory Conditions (S2.2).

**(T2S6.0) PLAYER #2's BASE**

This scenario takes place at player #2's battle station.

**(T2S6.1) NUMBER OF PLAYERS:** 2; player #1 and player #2.

**(T2S6.2) INITIAL SET-UP**

**PLAYER #1:** Ships and other units selected in (T2.13). These cannot include independent fighter or PF units. Enter within two hexes of 2230, heading A, speed max, WS-III.

**PLAYER #2:** Battle station in 2215. Ships and other units selected in (T2.13) within six hexes of 2215, facing optional, speed 10, WS-III.

**(T2S6.3) LENGTH OF SCENARIO:** The scenario continues until all forces belonging to one side have been destroyed, captured, or have disengaged.

**(T2S6.4) SPECIAL RULES**

**(T2S6.41) MAP:** Use a floating map. A player cannot disengage his forces in any given scenario until he has scored internal damage on at least one enemy ship or one of his own ships has been crippled.

**(T2S6.42) SHUTTLES AND PFs:** The presence of warp booster packs, MRS shuttles, and/or EW fighters is determined in campaign set up.

**(T2S6.43) COMMANDER'S OPTION ITEMS:** These are defined by (T2.16).

**(T2S6.5) VICTORY CONDITIONS:** Use the Standard Victory Conditions (S2.2).

**MINI-CAMPAIGNS IN OTHER PRODUCTS**

**(T3.0) THE LONE GRAY WOLF:** The Klingon dreadnought *Admiral Kang*, lured behind Kzinti lines by promises of a peace conference, finds itself alone and surrounded when talks break down. Advanced Missions.

**(T4.0) PIRACY PATROL:** A carrier and its escorts are sent to battle pirates on the wild frontier. Module J.

**(T5.0) CARRIER DUEL:** Two carriers engage in a series of battles for supremacy. Module J.

**(T6.0) THE RED WYN EXPRESS:** A rag-tag group of pirates and mercenaries steal Federation technology and run for the WYN Cluster. Module C1.

**(T7.0) THE RUN FOR HOME:** A group of Andromedan satellite ships try to reach home after their mothership suffers a catastrophe. Module C2.

**(T8.0) STEALING FIRST BASE:** The initial operation of the WYN War of Return. WYN forces try to capture a Kzinti base intact. Module C3.

**END OF SECTION (T0.0) BASIC SET**

## (U0.0) CAMPAIGN GAMES (Advanced Rules)

### (U1.0) GENERAL RULES

Campaign games consist of a series of scenarios that are played one after the other. The outcome of each scenario will have an effect on all succeeding scenarios. Between scenarios, ships are presumed to stop at a starbase or other facility for repairs and replacements. These repairs and replacement are described by this section.

#### (U1.1) DAMAGE REPAIR

Repair of damage is done by (D9.4) campaign repairs (G17.13).

#### (U1.2) REPLACEMENTS

**(U1.21) CREW:** All lost crew units and boarding parties are completely replaced after completion of (D9.4) repairs at the end of each scenario. Note that, as repairs are conducted before the crew is replaced, the penalty under (G9.452) must be enforced. See (G21.0).

**(U1.22) SHUTTLES:** Each ship receives one replacement shuttle after each scenario. If needed, the ship can draw other shuttles out of storage or place a shuttle into storage. If a ship already has a full complement of administrative shuttles (including those in storage), the replacement shuttle is lost and cannot be regained.

**(U1.23) FIGHTERS:** Each carrier receives a number of replacement fighters equal to one-half of its original complement (not counting spares) at the end of each scenario. (Round fractions of .5 or more up, and fractions of .49 or less down, to the next whole number.) The carrier can draw fighters from its internal spares and store fighters as spares (up to its listed maximum). Any surplus replacements are lost.

**EXAMPLE:** A Kzinti CV has 12 fighters plus 3 spares. If it lost eight fighters during one scenario, it would then have four plus three spares. Since it receives replacements equal to half the originals (six in this case) and can draw two out of its spare storage, it would then have twelve fighters plus one spare. If it only lost three fighters during the next scenario, it could replace them from the six new ones and put two of the new ones in storage, but it would then lose the sixth replacement because there is no room for it.

**(U1.24) DAMAGED SHUTTLES:** All damage to all shuttles (Note: fighters are shuttles) is completely repaired after each scenario.

**(U1.25) EXCHANGED SHUTTLES:** Carriers of a race can transfer fighters between themselves, allowing one to return for an overhaul while another gains its fighters. Fighters exchanged in this way can only be placed in the fighter boxes of the receiving carrier, or be used to replace fighters pulled from storage on the receiving carrier (i.e., be placed into storage themselves). Note that a receiving carrier may not be equipped with ready racks to operate the received fighters, and this will place limits on its operations (J4.896). There is an exception to the racial restriction in that Klingon and Lyran carriers can transfer fighters between themselves as if they were the same race. Carriers can transfer Admin shuttles to replace lost MRS shuttles, or transfer MRS shuttles to another carrier of the same race that is equipped to operate it. Fighters cannot replace shuttles at any time unless the ship specifically allows such exchanges, e.g., Federation GSC (R2.16) becoming CVL (R2.16A), or Hydran Gendarme (R9.39).

**(U1.26) LEGENDARY OFFICERS** (G22.0) killed in combat cannot be replaced. Those that have been disabled (G22.134) have recovered.

**(U1.27) PFs:** PF Tenders receive two replacement PFs after each scenario (one may be a leader or scout if the PFT lacks one of that type; the other must be a standard combat PF), but can never have more than they are designed to carry. Other ships that carry PFs (e.g., the D7C, Lyran Wildcat) receive one replacement PF after each scenario, but can never have more than they were designed to carry. Casual tenders (K2.114) cannot have leader or scout versions.

**(U1.28) UIMs:** Burned out UIMs are replaced between scenarios.

#### (U1.3) RESUPPLY

**(U1.31) SUPPLIES:** The ship is presumed to be completely resupplied with food, spare parts, etc., at the end of each scenario. These consumables are not within the scope of the game, and players can presume the ship's crew is taking care of these details.

**(U1.32) AMMUNITION:** All drone racks, plasma racks, drone storage, plasma-D storage, probe launchers, ADDs, and pseudo-plasmas are completely reloaded: all transporter bombs, mines (on mine sweepers/layers and Romulan old series ships), warp packs, fighter EW pods, chaff pods, etc. are replaced. See (U7.11) in the Commander's edition for production limits on SWACS. See (G27.7) for the limit on Cloaked Decoys. See (G26.1) in Advanced Missions for the limits on Web Anchors. See (J8.5) for limits on MRS shuttles.

**(U1.33) DRONES:** Drone spaces are replaced and onboard drones can be traded for different types of "special" drones, but the racial limitation on the numbers of "special" drones can never be exceeded.

**EXAMPLE:** A Kzinti BC had 32 spaces of drones. Twenty-two spaces were used in the last campaign phase. The 10 spaces remaining include four Spearfish drones. The Kzinti wants to carry some multi-warhead drones. However, he can not take any MW drones because he already has his full load of "limited availability" drones, even though he has 22 empty spaces. The Kzinti player turns in two of the spearfish drones (he could have turned in any or all) and selects the four MW drones he wants, and then fills the rest of his drone spaces with type-I drones.

**(U1.34) WARTIME STOCKS:** (Optional) In a campaign such as (U3.0), players are allowed 1,000 points to purchase better drones (the speed is assumed based on the time of the campaign), more boarding parties, MRS shuttles, etc. Thus, a player might have an unlimited supply of type-IF drones, but only 100 type-IVF heavy drones to last during the entire campaign.

#### (U1.4) OVERHAUL

**(U1.41) EFFECT OF OVERHAUL:** Once during the entire campaign, the player can have his ship "overhauled." This repairs all damage not repaired by (D9.0), but does not replace lost shuttles. There is a bonus for not using this overhaul; see (U2.4) or (U8.4).

**(U1.42) ADMIRAL'S GAME:** In the Star Fleet Admiral's game (U3.0), this limitation (U1.41) does not apply. A ship can be sent for an overhaul as often as the owning player may choose. However, the owning player cannot send more than one ship of size class 2, more than four ships of size class 3, and more than six ships of size class 4 to overhaul during the same round. He may send up to the maximum number from each size class at the same time. You can substitute a smaller ship for a larger one, but not vice versa.

**(U1.43) REFITS:** Players may wish to begin a campaign when various "refits" are just coming into service. It requires an overhaul to "refit" a ship. This will give the players an opportunity to "gradually upgrade" their fleet during the war. Players will have to decide, for example in the case of a Kzinti, if a CS in the line now is worth more than a BC in the line a round from now. Players will probably find that the ships that get refitted are those that have been sent to the rear for major repairs in any case. Note that a ship involved in the Captain's Game, or the Frigate Captain's Game (or other single ship campaigns that might be published) does not miss a round in the campaign to be overhauled. Other ships (not depicted) picked up the slack while it was overhauled (i.e., somewhere, someone was playing the Admiral's game and pulled your ship out of the line).

#### CAMPAIGNS IN OTHER PRODUCTS

**(U3.0) THE ADMIRAL'S GAME:** Advanced Missions.

**(U4.0) CARRIER GROUP CAMPAIGN:** Module J.

**(U5.0) ADMIRAL KOSNETT'S WAR:** Advanced Missions.

**(U6.0) OPERATION UNITY:** Module C2.

**(U7.0) CAMPAIGN NOTES:** Advanced Missions.

(U8.0) FRIGATE CAPTAIN'S GAME: Advanced Missions.  
 (U9.0) PF FLOTILLA CAMPAIGN: Module K.

**(U2.0) THE CAPTAIN'S GAME**

This campaign is intended to test your abilities as captain of a starship. This campaign is excellent for play at a tournament or convention. Selecting any ship in the game, you must play nine scenarios in the order given. This campaign represents the typical amount of action a ship might see in a period of about 5 years (of peacetime; wartime is much more active). Actually, however, it would be unusual to encounter this many monsters in such a short time.

**(U2.1) SCENARIOS OF THE CAPTAIN'S GAME**

The following scenarios comprise the Captain's Game:

1. (SG1.0) COMBAT AGAINST A SINGLE ENEMY SHIP
2. (SM1.0) THE PLANET CRUSHER (or Chart #1 below)
3. (SG1.0) COMBAT AGAINST A SINGLE ENEMY SHIP
4. (SM2.0) THE SPACE AMOEBA (or Chart #1 below)
5. (SG3.0) BASE DEFENSE
6. (SM3.0) THE MORAY EEL OF SPACE (or Chart #2 below)
7. (SH2.0) THE SURPRISE REVERSED
8. (SM4.0) THE COSMIC CLOUD (or Chart #2 below)
9. (SG5.0) DUEL WITH A PIRATE

**(U2.11) ALTERNATIVE FOR ADVANCED MISSIONS**

Players using Advanced Missions may expand the number of monsters available by using the charts below. Roll one die to determine which monster to use. Players without the more advanced products may substitute Chart #1 for Chart #2. Players might wish to select four monster scenarios for the campaign or have each captain roll for his own monsters as they are required.

**MONSTER SELECTION CHART #1**

- 1 (SM1.0) THE PLANET CRUSHER
- 2 (SM2.0) THE SPACE AMOEBA
- 3 (SM3.0) THE MORAY EEL OF SPACE
- 4 (SM4.0) THE COSMIC CLOUD
- 5 (SM5.0) THE SUNSNAKE
- 6 (SM6.0) THE MIND MONSTER

**MONSTER SELECTION CHART #2**

- 1 (SM7.0) SPACE DRAGON
- 2 (SM8.0) A STONE'S THROW
- 3 (SM9.0) THE DEATH PROBE
- 4 (SM10.0) THE COMBINING OF ARASTOZ
- 5 (SM11.0) ESCAPE FROM THE ENERGY MONSTER
- 6 (SH3.0) THE COMING OF THE METEOR

**(U2.2) SHIP SELECTION**

Players select a given race's ship and use it in all 9 scenarios. Opponents for scenarios 1, 3, 5, and 7 are shown on the chart below. One or more players are needed to play the enemy ships.

Player's Ship	Scen #1	Scen #3	Scen #5	Scen #7
Fed CA	Klingon D7	Kzinti BC	Gorn CA + CL	Romulan KR + 2xWE + 2xWB
Klingon D7	Fed CA	Gorn CA	Rom WE + 2xK5R	Kzinti CC + 2xCL + 2xFF
Gorn CA	Klingon D7	Kzinti BC	Fed CA + CL	Romulan KR + 2xWE + 2xWB
Kzinti BC	Romulan KR	Gorn CA	Fed CA + DD	Klingon D7 + D6 + 3xF5
Romulan KR	Kzinti BC	Klingon D7	Fed CA + CL	Gorn CA + CL + 3xDD

**(U2.3) ALTERNATIVES**

Any class of ship can be used for the campaign although the opponents should be of the same class (consider the Kzinti CV a DN for this purpose).

One interesting project, which will take some organization, is for a local club of five people to each take a ship (from a different race) and play the various scenarios against each other. In the case of the duels, this is straightforward. In the Base Defense scenario, players toss a coin to see who will be the attacker and who will be the defender. The attacker gets only his own ship; use a base station. In the Surprise Reversed scenario, each player should play against a player that is not participating in the campaign, or against one of the other players who is not using his campaign ship. Players of the Captain's Game can only be the defender (i.e., the side played by the Federation cruiser). Note that a player not participating in the campaign should play the pirate CR against all five opponents.

**(U2.4) HOW TO WIN**

Players score points in each of the nine scenarios based on their performance. The total of these points determines the level of success during the captain's 5-year mission. The method of scoring depends on the scenario type.

**MONSTER SCENARIOS:**

- Monster destroyed or contact established..... = 5 pts
- Ship disengages without destroying monster..... = 0 pts

**DUEL SCENARIOS:**

- Enemy ship destroyed, own ship crippled..... = 3 pts
- Enemy ship destroyed, own ship not crippled..... = 5 pts
- Enemy ship crippled, own ship not crippled..... = 3 pts
- Enemy ship received more damage..... = 1 pt
- Enemy ship captured, own ship not destroyed..... = 7 pts
- Pirate ship captured..... = 9 pts

**BASE DEFENSE:**

- Points scored as per (SG3.5)

**SURPRISE REVERSED:**

As per (SH2.5):

- Marginal or lower..... = 0 pts
- Tactical Victory..... = 2 pts
- Substantive Victory..... = 4 pts
- Decisive Victory..... = 6 pts
- Astounding Victory..... = 9 pts

BONUS for not using your "overhaul" (U1.4)..... = 5 pts

If the player's ship is destroyed or captured in any scenario, he loses 25 points and begins the next scenario with a brand new ship of the same class. Klingon ships that mutiny in monster scenarios disengage immediately, then return to player control. Klingon ships that mutiny in combat may be captured by the enemy player; see (G6.0). Note that only one of the listed point scores can be received for each scenario.

The fate of the player is determined by the total points he has achieved. Note that as there are two or three enemy ships in scenario #5, it is possible to obtain a maximum score of 71 or 78 points.

- Less than 10 pts..... = court-martialed and executed for treason\*
- 10-20..... = quietly retired at end of cruise
- 21-25..... = promoted to a desk job
- 26-30..... = assigned to teach at the academy
- 31-50..... = continued in command of his ship
- 51-65..... = promoted to commodore
- 66+..... = legendary captain, left in command (he's too valuable to promote)

\* except in the Federation, where there is no capital punishment. Within the Federation he is cashiered from service and may eventually wind up commanding a junk freighter or a pirate ship.

Obviously, if several players are playing the game competitively, the final scores will determine the winner.

**END OF SECTION (U0.0) BASIC SET**

## (Z0.0) NOTES AND INFORMATION

### (Z1.0) DESIGNER'S NOTES

There is considerable difficulty in doing a game on a subject where the "historical" data consists of some 100-odd hours of film, several novels, and a wide variety of semi-official "technical" data added by various people at various times with no particular effort to maintain any consistency. In putting all of this into a game format, one must first consider that any "battles" shown in the films are not the only battles ever fought and are likely to be the most unusual battles. Then the designer must construct a game system which will provide good results for "average" battles, and still account for the "unusual" ones.

In a historical game one can expect different sources to at least agree in their basic concepts. The real world is reasonably consistent. But in fiction in general, and this subject in particular, that consistency is simply not there. Not only do the later "add on" materials disagree considerably with the film in some cases, the various sections of the film disagree considerably with each other. The ancient bane of science-fiction writers (the speed of light and the distances to be covered) strikes home particularly hard in this universe, where we find that at maximum possible speed the ship could not cover the "five year mission" in anything less than 250 years. But if a game was to be done, all of these conflicts had to be resolved — compromised with each other to create a realistic and yet playable game system. In this game the designer has assumed the film to be correct (even where it contradicts itself) and tried to work in the other material as consistently as possible.

The designer began his work on this game by analyzing the ships. The basis of the game was the Federation heavy cruiser. In using it in the game, it was found to have certain weak points which should have been accounted for. The designer's solution was to create the "command cruiser." The dreadnought existed as a set of external blueprints and was easily factored into the game.

Problems began when the designer turned his attention to the Klingon battlecruiser. There exists a set of semi-official blueprints for this ship, but the blueprints do not agree with the film in key areas. The blueprint Klingon is literally bristling with phasers. These, of course, were never used on film. While rumor has it that the draftsman added them "because they looked good," the designer felt that he had to work them into the game. The solution came from another item on the blueprints, which indicated that the Klingons carried radar-homing drone missiles (also never used on film). The phasers were declared to be "defensive" phasers intended to protect the ship from drones. The relatively short range and low power neatly explained why they were never used on film. The unusual firing arcs of these phasers (all can fire to the rear, but less than half to the front) seemed to support this. But who was using drones against the Klingons?

The Kzintis were mentioned in some of the later films, and it seemed logical to use them for this hypothetical drone-using race. The few mentions of them in the novels (which do not cover the same incidents as the films) indicated that the Kzintis were near the Klingons and had previously fought them. The Kzinti strike cruiser was created by the designer as a balanced ship that was at the extreme end of the "drone technology" spectrum.

The Romulan blueprints (by the same draftsman that did the Klingons) also did not agree with the film. On film, Federation officers made the flat statement that the ship they were fighting used only "impulse" power and was purely sublight. The blueprints show a warp-capable ship. To be sure, the idea of a sublight ship in the film was rather ludicrous (it would have needed 50 years to cross the "Neutral Zone"), but the designer felt bound to honor the film. The blueprints were used as the basis of the War Eagle class. (The designation of "Warbird" for the sublight ship was invented by the designer and Lou Zocchi in a phone conversation in 1977. This term has since been adopted by the films.) The War Eagles make a good deal of sense. After the Klingon treaty provided the Romulans with warp technology, older Warbird hulls would be pulled into star docks for refit. For similar reasons, the Federation light cruiser was designed as a counter-part to the Warbird. The silhouettes on the counters caused another problem. The ship on the film has an

identical silhouette to that of the warp-speed cruiser in the blueprints. The solution was to rearrange the boxes on the SSD to make either ship fit the same outline.

The blueprints provided a considerable amount of technical data on the "plasma torpedo," but this, unfortunately, caused more problems than it solved. The blueprints showed that the War Eagle was just barely capable of firing one. Using any realistic mathematical model, the Warbird could not possibly fire such a weapon. The designer felt obligated to honor the film, and the plasma torpedo is factored for the Warbird. All things considered, it probably would have been much easier to ignore the film and use the blueprints. But despite the fact that the most enthusiastic fans probably have the blueprints, it was obvious that far more people would have seen only the film. Playtesting of the War Eagle showed that the addition of phasers (which do not appear in anything but this game) make the ship much more effective.

The Gorns presented other problems. While the designer insisted on including them (primarily to provide a variety of cruisers), there was very little information on them. Physically impressive and personally fearless, they seemed particularly loath to stand up and fight a Federation cruiser. This could indicate a severe shortage of ships, or perhaps an honest desire to avoid bloodshed. Their ships were created (by the designer) to show a mix of Federation and Romulan technology and a penchant for ground combat (hence the large number of shuttles).

The Tholian patrol ship is basically that used in Lou Zocchi's earlier set of miniatures rules. The improved PC is a more effective ship built on the same hull. The Orion CR was created from whole cloth to fulfill the assigned mission.

As to the game system itself, the designer felt that the basis had to be individual ships. This brought on the rather thorough "energy allocation" system. Careful analysis of the films demanded a proportional movement system to depict the warp-speed dogfights that are common in individual battles. The rest of the game more or less fell into place, using game mechanics to create the "feel" and the "flavor" of the film's technology.

### (Z1.1) NOTES ON THE COMMANDER'S EDITION

By 1983, the original 1979 edition of *STAR FLEET BATTLES* was overloaded with haphazard additions, changes, and corrections. It was clear that issuing yet another "expansion kit" that devoted half of its space to correcting previous products was not the answer. The result was the Commander's Edition, which appeared in three volumes (1983, 1984, and 1985).

Many changes were made. The rules were renumbered in the alphanumeric system (one of the very first games to use anything other than sequential numbering for its rules). The SSDs became the "Commander's" type with all of the charts on the page with the ship.

The Commander's Edition institutionalized the most basic flaw in the earlier editions: Addenda. This started out as simply corrections of mistakes. Then it expanded to include new material, and then "adjustments to obtain better balance" and then finally degenerated into just "messing with the rules." It was time for another edition.

### (Z1.2) NOTES ON THE CAPTAIN'S EDITION

It started as an off-hand comment by then-publisher Allen Eldridge: "You'll quit messing with the rules when Doomsday comes and not before."

Then it became an in-house joke. Whenever something really crazy came up (like three-dimensional SFB), someone would say "yeah, do that in the *Doomsday* Edition."

Then it became a public joke in an issue of the old *Nexus* magazine when we mentioned "a leather-bound multi-volume *Doomsday* rulebook" which would be done after everything else on the list of upcoming products.

*Doomsday* became a real project in 1987, at which point we began considering various means of getting it done. This did not happen until 1990, when the publisher was under new ownership. The new publishers wanted *Doomsday*, but delivery was slowed by the massive amount of work, the Persian Gulf War, and the delayed release of Steve Petrick (much needed design reinforcements for ADB) from the Army (which took 18 months to do paperwork that should have taken 18 hours. Ultimately, however, everything was in place and work on *Doomsday* began in earnest.

The long gestation, however, did give us time to plan an all-new edition. The publisher insisted that we should reorganize the game system into entirely new products. This was necessary to present the material to an entirely new generation of gamers in a more logical format (and to make dealers notice that it was a *new* edition).

In creating the Captain's Edition (as Doomsday came to be called), our priorities were:

- Incorporate all previous addenda.
- Answer all of the unanswered questions on file.
- Resolve all of the various contradictions between rules.
- Create a complete and balanced set of rules that would not require any further addenda. (This goal was, unfortunately, not accomplished and the result was the laer 1994 edition.)
- Create a new graphic format that would make the rules easier for players to access.
- Integrate into the rules all of the concepts that had been tossed on top of the pile over the years, such as active fire control and using cloaks (or ESGs) on any impulse.
- Improve the SSDs, make the SSD a formal part of the rule for the ship.
- Create a framework onto which new scenarios, ships, and other material can be easily added without having to re-wire the basic rules structure.

All of these goals (except for the errata, which took a revised edition) were met, and the Doomsday edition was a best seller.

Ultimately, however, the publisher was battered by market forces, a few bad decisions, and perhaps a lack of focus. The game system more or less disappeared from the market by the end of 1996 when ADB was unable to design new games without being paid for the previous ones. Two years of tedious negotiations were completed in January 1999 and Amarillo Design Bureau, Inc. was born. Four months later, the improved 1999 edition of the rulebook you now hold in your hands was published.—*Stephen V Cole, Designer*

## (Z2.0) ADVICE ON TACTICS

While tactics are a product of resources and the situation, there are some basic concepts that are common to most situations.

When first entering a combat situation, it is generally a good idea to begin arming weapons that will take some time to prepare. Long-range sniping with phasers and disruptors may be used to liven up the first turn, but a minimal amount of energy used to reinforce the forward shields will prevent this from causing any permanent shield damage.

Concentration of fire, both by a single ship or a fleet, is probably the single most important concept. To score any permanent shield damage, you must score enough hits to overcome reinforcement. To score any interior damage, you must overcome one of the shields. The most devastating attack any ship can launch is a combination of its phasers and heavier weapons (i.e. an "alpha strike") directly onto one enemy ship and onto one of his shields during a single impulse. If this shield has previously been destroyed or weakened, so much the better. (It is generally a good idea to take a slightly longer-ranged or less advantageous shot at a damaged shield than a closer shot at an undamaged one.) This will permanently destroy that shield and cause severe internal damage.

A ship with its forward shields down cannot effectively close the range with its opponent and must fight a "retreating" battle behind his rear shields (or fly into combat backwards, which is not very effective). If you cannot get a major penetration of a shield, you will have to take the "long road" and spend the first few turns hammering down two or three of his shields, at which point he cannot help but expose a weak shield to your concentrated fire.

One of the most basic tactics in SFB is the "MIZIA CONCEPT," named for the SFB player who invented it. The idea here is to knock down an enemy shield, then fire several smaller volleys through the down shield over the next few impulses so that you get the "one time" hits on the A-column of the Damage Allocation Chart. Such an attack will score many more weapons hits. Of course, once you penetrate a shield, your enemy will try anything (turns, sideslips, even a risky HET) to get that shield away from you. Combined direct-fire and seeking weapons can produce the effect as they strike during different portions of the impulse.

Klingon drones, when used against Federation ships, lessen the effect of the powerful Federation type-I phasers as the Federation ships must use powerful phasers to knock out small drones.

Kzinti ships (before the refits) call for entirely different tactics. Without a heavy offensive punch from direct-fire weapons, their primary ability to destroy an enemy requires overwhelming him with drones (so many that all can't be hit and some must get through). One way to do this is to launch one wave toward the target, follow them closely, and add a second wave on the next turn (thereby putting the maximum number of them in the target area at the same time). Drones require careful timing and shrewd tactical skill. Captains who can win with Kzinti ships have earned some bragging rights. After the refits, Kzintis act like Klingons with extra drones.

The Kzinti CV lends itself to even more interesting tactics. One possibility is to launch a wedge of fighters, which in turn launch a wedge of drones. The result is a powerful ship with two or three dozen "little brothers." Cleaning up the drones and fighters is a little like stepping on ants — you just can't get them all. Another tactic (that requires more skill) is to use the fighter group as an "artificial" starship. After all, it takes 96 hits to destroy it (12 x 8), and it has 12 phasers, not to mention drones. The carrier could then circle its opponent and drive it back into the fighters.

Ships armed with plasma torpedoes again require new tactics. The plasma torpedo is the single most powerful weapon in the game — IF properly employed. Firing from behind an enemy ship that is just working up to full speed will do little more than encourage him to leave (which he is probably doing anyway). If the range is even close to the difference in speed, you either won't catch him at all, or will do so only at the end of the torpedo's run, when its power is diminished sharply. The best time to release a plasma torpedo is directly in front of an opponent who is going too fast to brake and reverse direction. The only thing that he can do is reinforce the front shields, fire all his phasers at the torpedo at the last instant, and pray. Even with considerable luck, the torpedo will smash the front shield. The only real defense against a plasma torpedo is to avoid being in its primary short range firing arc, which makes tackling a plasma torpedo armed starship a tedious operation.

The "solution" to a massive plasma (or drone) attack is the wild weasel. This diverts most seeking weapons away from your ship. The problem with this solution is that you have a limited number of shuttles, they cost power to prepare, and once you use it your ship is at a slow speed in the presence of a very annoyed enemy. Speed is life in *STAR FLEET BATTLES*, and slowing down or using emergency deceleration around the enemy is asking him to try as hard as he can to kill you.

The classic plasma tactic is the renowned "Gorn Anchor." Here you simply move to point-blank range and slap a tractor beam on the target, preventing him from launching a wild weasel or running away. Most plasma tactics revolve around achieving or avoiding the Anchor.

Using shuttles (even Kzinti fighters) in a space battle creates an interesting situation. While they improve the offensive power of the ship (by the phaser-3s they carry) and its defense (by drawing fire), they have the effect of tying a starship to a speed at which they can keep station. Otherwise they end up being left behind. The life expectancy of shuttle crews is not great.

Every player of *STAR FLEET BATTLES* should have the chance to participate in an attack on a starbase, perhaps as a club project. The various tactical principles stated above apply, but it should be obvious that plasma torpedoes will be a particularly effective weapon. The firepower of a starbase, however, is more than capable of crippling at least one ship per turn, so don't waste any time once you have started.

Boarding parties add more new dimensions to tactics. If one shield can be knocked down, the marines can swarm aboard, knocking out security stations (causing Klingon mutiny) and heavy weapons (this may be the best way to deal with plasma torpedoes). Players should also experiment with the smaller ships of the games, particularly with the frigates. These ships require special handling and thought, as they are not just miniature starships, but have seriously different ratios of firepower to protection.

Further tactics will be found in the *STAR FLEET BATTLES TACTICS MANUAL*. Tactical discussions appear in Captain's Log in many formats (term papers, "victory at" articles, and other articles, and lively tactics discussions are held at the official SFB web site at [www.starfleetgames.com](http://www.starfleetgames.com) where you can compare notes with (and challenge the contentions of) the designers, playtesters, and staff. If you want a chance to work on future products, participation in these on-line BBS discussions is a good way to get noticed.

**(Z3.0) ADVICE TO NEW PLAYERS OF SIMULATION GAMES**

Due to the subject matter of this game, many people will have purchased it as their first venture into simulation gaming (i.e., "wargames" or "adventure games"). The designer's (and the company's) best wishes go out to these people who are entering a new and fascinating hobby. However, these people should be cautioned that *STAR FLEET BATTLES* is relatively complex as games go and may be simply too much for them to master. If you simply cannot master the game mechanics, or cannot understand what you are supposed to be doing, please do not give up! It is suggested that you return to the store where you purchased this game and ask the manager if he can put you in touch with other people who are playing it. These people will be able to show you how the game works and can also show you other games in this hobby that may interest you. Games are available on almost any historical, fantasy, or science-fiction subject.

The best way to start playing *STAR FLEET BATTLES* is in a group of experienced players, but if none is available, the second-best choice is the product *CADET TRAINING HANDBOOK*, which takes you through the most basic rules in a step-by-step approach.

As an alternative, there are any number of inexpensive introductory games on the market. Try one of these, and after you have mastered it, return to *STAR FLEET BATTLES*. Go to your store manager and list the science fiction and fantasy areas that interest you. He should be able to provide you with games, from a variety of companies and at a variety of price levels, on many of these areas.

**LOOKING FOR OPPONENTS?**

Send \$1 and a stamped self-addressed envelope to ADB Inc. and we will send you a list of known SFB players in your area. Some areas have more gamers than others, and sometimes the nearest SFBer may be an hour's drive away, but if you write in for the list, YOU will be on the list when the next SFBer in your area comes looking for new opponents. You can have yourself put on the list (without buying a copy of the list in your area) by dropping a letter or card to ADB Inc.

**(Z4.0) DESIGN CREDITS**

The CAPTAIN'S EDITION of *STAR FLEET BATTLES* is the third edition of this rulebook. As such, credits for design and development must reflect both those who originally worked on this game, those who participated in its continual expansion, and finally those who worked to create the Captain's Edition.

**(Z4.1) CREDITS FROM THE ORIGINAL EDITION**

Game Design ..... Stephen V. Cole  
 Game Development ..... Barry Jacobs  
 Developmental Playtesting ..... David W. Crump, Leslie H. Dixon  
 Primary Consultant ..... Franz Joseph Designs  
 Consultants ..... Lou Zocchi, Jeff Maynard

Playtesting:  
 Amarillo, TX ..... Mark Moody, R. Vance Buck, James Simms, James M. Brown, Ron Emch, Neal Hollis, Paul Knox, James Larsen, Dallas Paradise, Steve Wilcox, Kenneth Tucker, Richard "Ripcord" Giberson, Mike Giberson  
 Glen Burnie, MD ..... Mike Hillsgrove, Barry Richman, Paul Sangster, Robert Yates, Robert Meredith, Richard Shipley, Dave Hazel, Steve Naus, Paul Waters, Jimmy Warren  
 Flint, MI ..... Craig L. Carey, Tony Landino, Gary Bourassa  
 Denver, CO ..... Bill Anderson  
 Fort Worth, TX ..... Henry Williams

**(Z4.2) CREDITS FOR DEVELOPMENT AND EXPANSION OF THE POCKET EDITION**

The Commander's Edition was developed from its predecessor versions over a period of 4 years. Some of the people involved in this development include: Stephen G. Wilcox, Barry A. Jacobs, Eric Kuniholm, Mike Hillsgrove, Mike Thompson, Craig L. Carey, the Rev. Ron Wheeler, Mark Moody, Ken Hart, Richard Kerr, and Kenneth Tucker. Specific design credits are as follows:

Battlepod, Q-Ships ..... Barry Jacobs  
 Drone rack types, Plasma Shotgun ..... Mike Thompson  
 Enveloping Plasma Torpedo ..... Graeme Cree  
 Mass-based Movement system ..... Mike Hillsgrove  
 Pseudo-Pod ..... Allen D. Eldridge

**(Z4.3) CREDITS FOR THE COMMANDER'S EDITION**

Game Design ..... Stephen V. Cole, PE  
 Game Development ..... C. Michael Thompson, Ray D. Olesen, C. H. Graeme Cree, Josh Spencer, and Felix Hack  
 Review and Comment ..... David Crump, Richard Kerr, Ken Hart, Mark Moody, Frank Crull, Ken Annett, Ken Kaufman, John Graesser, R. O. Griggs, Alex Matthews.  
 Consultants ..... Lou Zocchi, Franz Joseph Designs

**(Z4.4) CREDITS FOR THE CAPTAIN'S EDITION**

Game Design ..... Stephen V. Cole, PE  
 Executive Developer ..... Steven P. Petrick  
 Chief of ADB Operations ..... Leanna M. Cole  
 Star Fleet Committee ..... Ray D. Olesen, Frank Crull, Keith Velleux, Owen Riley, Scot McConnachie.  
 Product Staff (1990 Edition) .... John D. Berg, Tom Carroll, Marc Cocherl, Gregg Dieckhaus, John Hammer, Jim Hart, Bill Heim, Stewart Frazier, Anthony Medici, Marc Michalik, Eric Nussberger, Scott Olson, Rob Patterson, Evelio Perez-Albuerne, Steve Rossi, Steve Rushing, Mark Schultz, Tony Zbaraschuk.  
 Additional Staff (94 Edition) .... Ken Burnside, Chris Cafiero, Jon Cleaves, Mike Filsinger, Bruce Graw, Jeff Laikind, Scott Mercer, Gary Plana, Chuck Strong, Reece Watkins, Cliff Yahnke.  
 Additional Staff (99 Edition) .... Joe Butler, Richard Eitzen, Mike Calhoon, Jim Hart, Garth L. Getgen, Scott Moellmer.  
 Development (83-89) ..... Stacy Bartley, Josh Spencer, Ken Kaufman, Jeff Smith, Alan Gopin, Steve Kay, Ron Spitzer, David Zimdars, Mike West, Graeme Bayless.  
 Typesetting ..... Microsoft Word 98, Macintosh.  
 Graphic Design and Layout ..... Leanna M. Cole  
 Chief of ADB Security ..... Blackie  
 Security Staff ..... Waylon, R. Rex  
 Production & Marketing ..... Stephen V Cole  
 Printers ..... Dallas Offset, Dallas Texas.  
 Die Cutting, Boxes ..... Trafton Printing, Amarillo  
 Cover Art ..... Michael Winterbauer  
 Computer Art ..... Stephen V. Cole, Aldus Freehand

**(Z5.0) THE STAR FLEET UNIVERSE**

Most STAR FLEET UNIVERSE products are by Amarillo Design Bureau, inc., which also publishes, markets, and distributes these products. *STAR FLEET BATTLES* (of which Basic Set is the foundation) is the tactical game from the *STAR FLEET UNIVERSE*. The strategic background for SFB and a campaign system can be found in the game *FEDERATION AND EMPIRE*, which is also produced and designed by Amarillo Design Bureau.

The CAPTAIN'S EDITION is a complete redesign of the previous COMMANDER'S EDITION, which is now out of date. The CAPTAIN'S EDITION includes many interrelated products, some of which are listed below.

**CURRENT PRODUCT LINE:** The Captain's Edition (1999) includes the following products:

- ★ **BASIC SET** (this rulebook) includes the basic rules, the original races of the universe, and the most common ships. Basic Set is roughly equivalent to Commander's Volume I.
- ★ **ADVANCED MISSIONS** adds many advanced rules needed to play at the expert level and many more ships for the seven basic races. It also includes many new scenarios. Advanced Missions includes much of the material from Commander's Volumes II and III.
- ★ **CAPTAIN'S MODULE C1: NEW WORLDS I** adds three additional races to the game system. The Lyrans are Klingon allies and enemies of the Kzintis. Their double-hull ships use the powerful Expanding Sphere Generator. The Hydrans are enemies of the Klingons and Lyrans. Their ships almost all carry fighters. The WYNs are a small neutral enclave on the Klingon-Kzinti-Lyran border. Module C1 draws much of its material from Commander's Volumes II and III.
- ★ **CAPTAIN'S MODULE C2: NEW WORLDS II** includes three more races for the SFB game system. The Neo-Tholians arrived from the original Tholian galaxy just in time to use their incredible Web Caster to save the Holdfast from destruction. The Andromedans invade our galaxy and try to wipe out everyone. The ISC are a peace-loving race which feels that the rest of the galaxy is occupied by dangerous lunatics who should be saved from themselves. Module C2 draws much of its material from Commander's Volumes II and III.
- ★ **CAPTAIN'S MODULE C3: NEW WORLDS III** will bring new minor races (for example, the Lyran Democratic Republic) as well as segments for existing races (for example, Andromedan bases and the WYN War of Return).
- ★ **CAPTAIN'S MODULE C4: FLEET TRAINING CENTERS** adds nine new races to the game system, but these races are like no others. They are artificial "simulator" races used for training captains to deal with unusual circumstances. As such, they include unusual weapons which would be impossible within the normal game universe. The Frax mount their weapons in "wet navy" FX/RX arcs. The Triaxians move in three dimensions rather than two, and have various new types of plasma torpedoes. The Qaris mount their kinetic weapons in rotating armored turrets. The Britainians mount their weapons for broadside fire. The Canadi'ens fly the deadly Maple Leaf Mauler. The Sharkhunters use wire-guided plasma torpedoes and flash bombs to hunt cloaked ships. The Barbarians can be rebuilt to reflect any tactics you want. The Flivvers can fly sideways and backwards. The Deltans are the fastest ships in the game but can barely turn.
- ★ **CAPTAIN'S MODULE D3: BOOMS & SAUCERS** includes the special SSDs needed for separated Federation saucers, Klingon booms, and Tholian rear hulls; two scenarios.
- ★ **CAPTAIN'S MODULE J: FIGHTERS** contains many new rules, ships, fighters, and scenarios for most races. New counters and SSDs are included. Module J includes the material from Commander's Supplement #1 as well as much additional material.
- ★ **CAPTAIN'S MODULE K: FAST PATROL SHIPS** contains all of the rules and other data for PFs, the small gunboats that became the terror of the Star Fleet Universe in the later years of the General War. SSDs and counters are provided

to represent new ships and PFs of races that used them. This covers most of the ground from Supplement #3.

- ★ **CAPTAIN'S MODULE M: STAR FLEET MARINES** includes detailed boarding party actions and ground combat, plus dozens of entirely new starships.
- ★ **CAPTAIN'S MODULE R1: NEW SHIPS I** includes SSDs and counters for all of the bases, freighters, and auxiliary ships, as well as many play aids and other items. Like Modules R2-4, R1 incorporates material from the various SSD books, Volume III, and Reinforcements packages from the Commander's Edition.
- ★ **CAPTAIN'S MODULE R2: NEW SHIPS II** includes SSDs and counters for more Federation, Kzinti, Orion, and Andromedan ships.
- ★ **CAPTAIN'S MODULE R3: NEW SHIPS III** includes SSDs and counters for more Klingon, Lyran, Hydran, and WYN ships.
- ★ **CAPTAIN'S MODULE R4: NEW SHIPS IV** includes SSDs and counters for more Romulan Gorn, Tholian, and ISC ships.
- ★ **CAPTAIN'S MODULE R5: BATTLESHIPS** provides large ships for most races, including Heavy Command Cruisers, Battle Control Ships, Heavy War Cruisers, and conjectural Battleships.
- ★ **CAPTAIN'S MODULE R6: THE FAST WARSHIPS** includes new classes of ships for unusual special missions.
- ★ **CAPTAIN'S MODULE S1** includes 50 more exciting scenarios!
- ★ **CAPTAIN'S MODULE S2** has even more exciting scenarios!
- ★ **CAPTAIN'S MODULE T: TOURNAMENT PACK** has everything you need to play in (or run) SFB and F&E tournaments.
- ★ **CAPTAIN'S MODULE X1: FIRST-GENERATION X-SHIPS** portrays the improved technology vessels that appeared at the very end of the General War.
- ★ **CAPTAIN'S TACTICS MANUAL:** This is a revision of the 1987 Tactics Manual, completely updated to help you learn the nuances of the new Captain's rules.
- ★ **CAMPAIGN DESIGNER'S HANDBOOK** helps players set up campaigns for their local groups to play.

**CONTINUING RELEASES:** These items appear at intervals.

- ★ **CAPTAIN'S LOG** is the official journal of the Star Fleet Universe. This module appears in magazine format two or three times per year. Log #18 went to press in May 99.
- ★ **STAR FLEET 2300 MINIATURES:** These metal sculptures of starships have been a part of SFB for decades and will return to stores at a future date.
- ★ **STAR FLEET TIMES**, the official newsletter, includes rules updates, new ships, playtest scenarios, product announcements, and prototype rules. If you want to be a playtester, subscribe to Starletter and start sending in reports.

**FUTURE DEVELOPMENT:** The following products are planned for release over the next several years. They are listed here so that you will know why certain rule numbers have been reserved. Many other products are under consideration which are not listed here.

The release schedule for the products below has not been set. Please do not annoy your store manager asking about these products. Consult Star Fleet Times or Captain's Log for updated release schedules, or inquire from ADB Inc.

- ★ **STAR FLEET ACADEMY:** A boxed product with a simplified set of Star Fleet Battles rules and only a few of the basic ships. Academy is designed as a complete stand-alone game for the mass market, but can serve as an introduction to the more exotic world of Star Fleet Battles.
- ★ **CAPTAIN'S MODULE A: BATTLECARDS!** Is a card-based play-aid designed to speed play.
- ★ **CAPTAIN'S MODULE Q: SUBLIGHT BATTLES:** pre-warp era.
- ★ **CAPTAIN'S MODULE V: OPERATIONAL MOVEMENT** presents an intermediate level of play between SFB and F&E.
- ★ **CAPTAIN'S MODULE X2: SECOND-GENERATION X-SHIPS.**
- ★ **CAPTAIN'S MODULE R7: DREADNOUGHTS AT WAR** will present more of the huge ships players have demanded.
- ★ **CAPTAIN'S MODULE Y: THE EARLY YEARS** covers the early warp period (Y80-120) when ships were slower and technology was less advanced.
- ★ Many other products are under consideration, including several other galaxies, fiction-based journals, play aids, new ships, new scenarios, and much more.



**FEDERATION & EMPIRE** is the strategic game of the Star Fleet Universe and The General War.

- ★ **DELUXE FEDERATION & EMPIRE** covers the grand scope of the galaxy on a one-ship/one-counter basis. Included is an 80-page rulebook, a huge 19x45" map, 1512 counters, and various charts.
- ★ **SPECIAL OPERATIONS** includes rules and counters for tug pods, electronic warfare, SFGs, and special units. Includes 2 scenarios, 324 counters, four new fleet charts, and more!
- ★ **CARRIER WAR** includes seven new mini-scenarios, each playable in a single evening, plus rules for carrier group formation, Fed SWACs, and Klingon Swarms. Includes 324 counters and a complete set of scenario set up charts.
- ★ **MARINE ASSAULT** includes commando ships and ground combat.
- ★ New F&E products and expansions are in development. These include EcoWar, Civil Wars, AndroWar, and ISC-War.

**PRIME DIRECTIVE** is the Role-Playing game of the Star Fleet Universe. Players are members of an elite Federation Prime Team, a combination of commandoes, hostage rescue, diplomatic contact, and scientific research team.

**STAR FLEET MISSIONS** is a mass-market card game designed for the entire family to enjoy.

**(Z6.0) COPYRIGHT AND PUBLISHER'S INFORMATION**

**(Z6.1) PUBLISHER'S INFORMATION**

**STAR FLEET BATTLES — THE CAPTAIN'S EDITION BASIC SET** was created and published by Amarillo Design Bureau Inc.

**AMARILLO DESIGN BUREAU INC.**  
 POST OFFICE BOX 8759  
 AMARILLO, TEXAS 79118-8759  
 Telephone: 806-351-1950  
 Fax: 806-351-2585  
 Email: design@starfleetgames.com  
 Sales: sales@starfleetgames.com  
 Web Site: www.starfleetgames.com

Most of the information players seek is on the web site. You may also contact ADB Inc. by mail (include a stamped self-addressed envelope) if you have rules questions, inquiries on product release schedules, orders for products or spare parts, requests for a catalog, requests for replacement of missing or defective parts, or submissions of art and new game materials. All consumer correspondence requires a stamped self-addressed envelope.

Dealer inquiries are welcome. Hobby and game stores, please write ADB Inc. on your letterhead and ask for a list of qualified wholesalers, or call us and ask for a salesman. ADB Inc. products are available to individuals in retail stores, from several direct mail outlets, and directly from us. If your store does not carry ADB Inc. products, send us his name and address and we'll have our wholesalers contact him.

**(Z6.2) QUESTIONS**

Questions, suggestions, and any expansion material for the STAR FLEET UNIVERSE should be sent only to Amarillo Design Bureau, Post Office Box 8759, Amarillo, TX 79114. All correspondence must include a stamped self-addressed envelope if you wish to receive an answer or evaluation of your submission. Your return envelope MUST bear enough postage to cover the return of your questions (about four pages to one first class stamp). Foreign customers should enclose three International Reply Coupons, not foreign stamps or money.

It is imperative that you place your name and address on EVERY page of your correspondence. Do not put questions and expansion material on the same sheet. sending questions, phrase each one so that it can be answered with a yes or no, a brief answer, or by circling one of several choices. Leave several blank lines after

each question (not each group of questions). In order to better serve the player community, letters asking 10 or fewer questions are given priority and are answered in 2-3 days. Letters with more questions are answered only as time permits (allow 2-3 weeks). Please attempt to look up the answer yourself first. We will cheerfully answer questions about how the rules work, but cannot answer questions as to "WHY?" various things work the way that they do. Such "WHY?" questions are sometimes printed (with answers) in Captain's Log.

All future products for the STAR FLEET UNIVERSE will be prepared by ADB; all questions relating to existing products will be answered by ADB.

**(Z6.3) SUBMISSIONS OF NEW MATERIAL**

Amarillo Design Bureau Inc. welcomes the submission of new material for use in future Star Fleet Universe products. Scenarios, articles for Captain's Log, play aids, and fiction are most welcome. New rules, ships, and systems are difficult to use but will be considered. New races are very difficult to publish and most will be filed unread. Product ideas relating to the Star Fleet Universe background but not to SFB or F&E will be considered.

All submissions of new material are accepted ONLY under the following terms unless specifically agreed otherwise in writing by ADB: All materials submitted immediately become the property of Amarillo Design Bureau Inc. and may be used, modified, expanded, or changed as we see fit. All materials used will be credited to the original author to the extent of his original submission.

All submissions MUST include a stamped self-addressed envelope for use in sending you an evaluation of your material; the material itself cannot be returned. You should retain a complete copy of your material for your own use.

Authors submitting material used in Captain's Log will be paid at standard rates set from time to time by ADB. Authors submitting other material used in a future product will receive a copy of that product or other compensation at the discretion of ADB.

Submission of any material is considered to be acceptance of these terms, which are legally binding on all submissions not specifically exempted by the Bureau in advance and in writing.

For additional details, contact the Bureau, or see the more extensive section on submissions in Advanced Missions.

Standard rates are as follows:

Small items (suggestions, term papers) byline only.

Scenarios, ships, and similar items of about one page: Free copy of the product in which it is used.

Fiction is paid at \$15 per published page, minus any elements (e.g., art) not created by you.

B&W art is paid at \$25 for standard 1/6 page pictures as used.

Larger items up to entire products are paid a negotiated sum possibly including royalties.

Some players who create entire products publish them under our *Stellar Shadows* product line; ADB Inc. handles production and marketing for these products and remits a share of revenue to the designer. You can contact ADB Inc. for details on this program.

**(Z6.4) COPYRIGHT INFORMATION**

The original Designer's Edition of *STAR FLEET BATTLES* was copyright © 1979 by Stephen V. Cole and Allen D. Eldridge.

*STAR FLEET BATTLES — THE COMMANDER'S EDITION* and all contents thereof is copyright © 1983 by Amarillo Design Bureau and Stephen V. Cole. Some revised elements are copyright © 1984 or later. All rights are reserved under the Pan-American, Berne, and International Copyright Conventions.

*STAR FLEET BATTLES — THE CAPTAIN'S EDITION BASIC SET* and all contents thereof are copyright © 1990 by Amarillo Design Bureau. Second Printing copyright © 1994 by Amarillo Design Bureau. Third Printing copyright © 1999 Amarillo Design Bureau, Inc. All rights are reserved under the Pan-American, Berne, and International Copyright Conventions.

This game was produced under license from Franz Joseph Designs, authors of the *STAR FLEET TECHNICAL MANUAL*.

Elements of the Star Fleet Universe are the property of Paramount Pictures Corporation and are used with their permission.

**END OF SECTION (Z0.0) BASIC SET**

**TYPE I OFFENSIVE PHASER TABLE**

DIE ROLL	RANGE										
	0	1	2	3	4	5	6-8	9-15	16-25	26-50	51-75
1	9	8	7	6	5	5	4	3	2	1	1
2	8	7	6	5	5	4	3	2	1	1	0
3	7	5	5	4	4	4	3	1	0	0	0
4	6	4	4	4	4	3	2	0	0	0	0
5	5	4	4	4	3	3	1	0	0	0	0
6	4	4	3	3	2	2	0	0	0	0	0

**TYPE II OFFENSIVE/DEFENSIVE PHASER TABLE**

DIE ROLL	RANGE							
	0	1	2	3	4-8	9-15	16-30	31-50
1	6	5	5	4	3	2	1	1
2	6	5	4	4	2	1	1	0
3	6	4	4	4	1	1	0	0
4	5	4	4	3	1	0	0	0
5	5	4	3	3	0	0	0	0
6	5	3	3	3	0	0	0	0

**TYPE III DEFENSIVE PHASER TABLE**

DIE ROLL	RANGE					
	0	1	2	3	4-8	9-15
1	4	4	4	3	1	1
2	4	4	4	2	1	0
3	4	4	4	1	0	0
4	4	4	3	0	0	0
5	4	3	2	0	0	0
6	3	3	1	0	0	0

**TYPE IV HEAVY PHASER TABLE**

DIE ROLL	RANGE												
	0-3	4-5	6	7	8	9	10	11-13	14-17	18-25	26-40	41-70	71-100
1	20	20	20	15	12	10	8	6	5	4	3	2	1
2	20	20	15	12	11	9	8	6	4	3	2	1	0
3	20	15	12	11	10	8	7	5	4	2	1	0	0
4	20	15	11	10	9	8	6	4	3	1	0	0	0
5	15	12	10	9	8	7	5	3	2	0	0	0	0
6	15	10	9	8	7	6	5	3	1	0	0	0	0

**PHOTON TORPEDO TABLE**

RANGE	RANGE						
	0-1	2	3-4	5-8	9-12	13-30	
HIT, STANDARD	NA	1-5	1-4	1-3	1-2	1	
HIT, PROXIMITY	NA	NA	NA	NA	1-4	1-3	
HIT, OVERLOAD	1-6	1-5	1-4	1-3	NA	NA	
DAMAGE, STANDARD	NA	8	8	8	8	8	
DAMAGE, PROXIMITY	NA	NA	NA	NA	4	4	
DAMAGE, OVERLOAD	———VARIES———				NA	NA	

**ANTI-DRONE TABLE**

RANGE	0	1	2	3	4+
HIT #	—	1-2	1-3	1-4	—

**DISRUPTOR TABLE**

RANGE	RANGE								
	0	1	2	3-4	5-8	9-15	16-22	23-30	31-40
HIT, STANDARD	NA	1-5	1-5	1-4	1-4	1-4	1-3	1-2	1-2
HIT, UIM	NA	1-5	1-5	1-4	1-4	1-4	1-4	1-2	1-2
HIT, DERFACS	NA	1-5	1-5	1-4	1-4	1-4	1-3	1-3	1-2
HIT, OVERLOAD	1-6	1-5	1-5	1-4	1-4	NA	NA	NA	NA
HIT, OVERLOAD/UIM	1-6	1-5	1-5	1-5	1-5	NA	NA	NA	NA
DAMAGE, STANDARD	0	5	4	4	3	3	2	2	1
DAMAGE, OVERLOAD	10	10	8	8	6	0	0	0	0

**PLASMA TORPEDO TABLE IS IN (FP1.53)**

**ANNEXES**

STAR FLEET BATTLES is a richly detailed game system. There are a lot of units (ships, bases, fighters, etc.) in the game, and there is a great deal of information about each one of them.

The Annexes are a compilation of this data. Each Annex or sub-Annex deals with a specific type of information that you will need to find while playing the game. The general idea is that when a new product brings into the game a ship or some other unit which was not even imagined at the time the various rules were written, the annexes (but not the rules) will be replaced with a new edition that includes all of the new ships, fighters, or whatever.

**INDEX OF ANNEXES**

1. INDEX OF THE GAME
2. SEQUENCE OF PLAY
3. MASTER SHIP CHART
  - 3A. Tug Move Costs and Turn Modes
4. MASTER FIGHTER CHART
5. ABBREVIATIONS
6. COMMANDER'S OPTION ITEMS
7. SHIP DATA
  - 7A. Color of Counters
  - 7B. Ships Able to Land on Planets
  - 7C. Orders of Battle
  - 7D. Systems Defined as "Weapons"
  - 7E. Damage Conversion Chart
  - 7G. Carrier Information
  - 7L. Unit Towing Costs
  - 7P. Systems Affected by Scanners
8. WEAPONS DATA
  - 8A. Disruptor Range Table
  - 8B. Orion Optional Weapons Costs
9. COST OF REPAIRCHART
12. MONSTER DATA TABLE

**NOTE:** The "missing" annexes from the above list do not apply to Basic Set and are found in Advanced Missions or other products.

**ANNEX #1 INDEX**

Acceleration.....	C2.2
Active Terminal Guidance.....	FD5.2
Administrative Shuttles.....	J2.0
Aerodynamic Landing System.....	P2.433
Annexes.....	A3.16
Anti-Drones.....	E5.0
Anti-Matter Bombs.....	G5.3
Armor.....	D4.12
Asteroids.....	P3.0
ATG (Active Terminal Guidance).....	FD5.2
Atmosphere (Combat).....	P2.5
Atmospheres, Structure of.....	P2.6
Atmospheric Movement.....	P2.8
Auxiliary Carriers.....	R1.13
Auxiliary Control.....	G2.1
Auxiliary Power Reactors.....	H4.0
Auxiliary Warp Reactors.....	H2.3, H4.3
Background.....	A3.3
Balcony and Track.....	J1.53
Ballistic Targeting.....	F4.0
Base Augmentation Module.....	R1.1B
Base Stations (BS).....	R1.3
Bases on Planets.....	P2.7
Bases.....	R0.6
Basic Point Value.....	S2.1
Batteries.....	H5.0
Battle Damage: Code Red.....	D4.6
Battle Stations.....	R1.2
Battle Cards!.....	D4.7
Black Hole.....	P4.0
Boarding Parties, Basic.....	D7.0
Booby Trap.....	D7.622
Breakdown, HETs.....	C6.5
Breakdown, Quick Reverse.....	C3.61
Breakdown, Tractor.....	G7.322
Breakdown, Web Deceleration.....	G10.59
Bridge.....	G2.1
Cadet's Game.....	A4.0
Campaign Games.....	U0.0
Captain's Game.....	U2.0
Captain's Log.....	Z5.0
Capturing a Ship.....	D7.5
Carrier Data Charts.....	R0.7
Carrier Operations.....	J4.6
Cartels, Orion.....	R8.0
Casual Carrier.....	J4.62
Circuits, EW.....	D6.312
Cloaking Device.....	G13.0
Cloaking, Hidden Movement.....	G13.61
Close Combat Maneuvering.....	J4.5
Collateral Damage.....	J3.3
Combat.....	D0.0
Command Cards.....	B2.4
Commander's Options.....	M3.13, S3.2, Anx #6
Contingent Reserve Power.....	H7.6
Continuous Damage Repair.....	D9.7
Continuous Tracking, Seeking Weapons.....	F2.6
Control Systems.....	G2.0
Controller.....	C1.44
Copyright Information.....	Z0.0
Crash Landings.....	P2.431
Credits.....	Z0.0
Crew Units.....	G9.0
Crippled Ships.....	S2.4
Crippled Shuttles.....	J1.33
Critical Hits.....	D8.0
Damage Allocation.....	D4.0
Damage Allocation, Starbases.....	R1.1D
Damage Control.....	D9.0
Damage Control, Shields.....	D9.2
Damage Conversion.....	D4.323
Damage Repair, Campaign.....	D9.4
Damage Repair, Continuous.....	D9.7
Death Dragging.....	G7.54, J1.212

Deceleration.....	C2.22
Deck Crews.....	J4.81
DERFACS.....	E3.62
Designer's Notes.....	Z0.0
Directed Turn Modes.....	C3.8
Direct-Fire Weapons.....	E0.0
Discharging Weapons.....	E1.24
Disengagement by Acceleration.....	C7.1
Disengagement by Separation.....	C7.2
Disengagement by Sublight Evasion.....	C7.3
Disengagement.....	C7.0
Disengagement, Automatic.....	C7.4
Disrupted Fire Control.....	D6.68
Disruptors.....	E3.0
Dogfight Drones.....	FD2.5, FD5.1
Drone Racks, Types of.....	FD3.0
Drones.....	FD0.0
Drones, Energy Seeking.....	Dogfight Drones
Drones, Firing (Launch) Rates.....	FD4.0
Drones, Firing at.....	FD1.5
Drones, Guidance of.....	FD5.0
Drones, Launch Rates, Fighters.....	J4.24
Drones, Loading.....	FD2.4, J4.82
Drones, Methods of Control.....	FD5.0
Drones, Rails on Fighters.....	J4.23
Drones, Scatter-Pack.....	FD7.0
Drones, Storage.....	FD2.44, J4.71, R2.R5
Drones, Types of.....	FD2.0
Effective Range.....	D1.4
Effective Speed.....	C2.412, C2.45
Electronic Counter Measures.....	D6.3
Electronic Counter-Counter Measures.....	D6.3
Electronic Warfare Circuits.....	D6.312
Electronic Warfare.....	D6.3
Electronic Warfare for Fighters.....	J4.9
Electronic Warfare Pods.....	J4.96
Elevators, Hangar Bay.....	J1.591
Emergency Bridge.....	G2.1
Emergency Deceleration.....	C8.0
Emergency Life Support.....	B3.1 (7)
Energizing Phasers.....	E2.3
Energy Allocation.....	B3.0
Engine Doubling (Orion).....	G15.2
Engines.....	H2.0, H3.0
Enveloping Plasma Torpedo.....	FP5.0
Evasion Plotting.....	C1.3223
Excess Damage.....	D4.4
Explosions, Mines.....	M2.5
Explosions, Ships.....	D4.4, D5.2
External Bays (Shuttle).....	J1.55
Facing.....	C1.2
Federation Ships.....	R2.0
Fighter Squadrons.....	J4.46
Fighters.....	J4.0
Fighters, EW.....	J4.9
Fighters, Rearming.....	J4.8
Fire Control.....	D6.0
Fire Control, Active.....	D6.6
Fire Control, Disrupted.....	D6.68
Fire Control, Low-Power.....	D6.7
Firing Arcs.....	D2.0
Flag Bridge.....	G2.1
Fractional Accounting.....	B3.2
Fractions, Rounding.....	A3.5
Free Movement.....	C1.31
Freighters.....	R1.5, R1.6
Freighters, Carried by Tugs.....	G14.73
Friendly Fire.....	D1.5
Fully-Capable Carrier.....	J4.61
Gas Giants.....	P2.22
Gatling Phasers.....	E2.15
Gorn Anchor.....	G7.98, Z2.0
Gorn Ships.....	R6.0
Gravity Landing System.....	P2.432
Guards.....	D7.83
Hangar Bay Elevators.....	J1.591
Hangar Bay Modules.....	R1.4

Hangar Bays, Interbay Transfers.....	J1.59	Planetary Rings.....	P2.223	Shuttlecraft, Crippled.....	J1.33
Heading.....	C1.2	Planets.....	P2.0	Shuttlecraft, Repair by Deck Crew.....	J4.818
HET Bonus.....	C6.52	Planets, Structure of.....	P2.6	Shuttlecraft, Sublight.....	J2.3
HET Bonus, Orion.....	C6.521	Plasma Bolts.....	FP8.0	Sideslip.....	C4.0
Hidden Movement, Cloaking.....	G13.61	Plasma Shotgun.....	FP7.0	Size Class.....	R0.6
High Energy Turns.....	C6.0	Plasma Torpedoes.....	FP0.0	Small Ground Bases.....	P2.76
Hit-and-Run Raids.....	D7.8	Plasma Torpedoes, Bolting.....	FP8.0	Small Planets.....	P2.23
Hull.....	G3.0	Plasma Torpedoes, Enveloping.....	FP5.0	Small Target Modifiers.....	E1.7
Identifying Seeking Weapons.....	F1.4, G4.2, G5.25, J2.15	Plasma Torpedoes, Firing Arcs.....	FP3.0	Speed.....	C2.4
Impulse (Part of a Turn).....	B2.3 (#6)	Plasma Torpedoes, Firing at.....	FP1.6	SSD.....	R0.8, R0.2
Impulse Cards.....	C1.44	Plasma Torpedoes, Guidance of.....	FP4.0	SSD, Inspection of.....	D4.14
Impulse Engines.....	H3.0	Plasma Torpedoes, Pseudo-Plasma.....	FP6.0	Stacking.....	C1.6
Impulse of Decision.....	E1.52	Plasma Torpedoes, Types of.....	FP2.0	Standard Victory Conditions.....	S2.20
Impulse of Truth.....	E1.52	Plotting Movement.....	C1.3	Star Fleet Universe.....	Z5.0
Impulse TAC.....	C5.1	Pods (and Tugs).....	G14.0	Starbases.....	R1.1
Information.....	Identifying Seeking Weapons, Scientific Information	Point Defense Drones.....	see anti-drones	Starletter.....	Z5.0
Jump Racks.....	FD3.6	Positron Flywheel.....	C9.0	Starline 2200.....	see Miniatures
Klingon Ships.....	R3.0	Power Systems.....	H0.0	Station Keeping.....	C1.3224
Klingons, Early Drone Launch Rate.....	FD4.3	Practical Speed.....	C2.411	Stealth Bonus (Orion).....	G15.8
Kzinti Ships.....	R5.0	Probes.....	G5.0	Strategic Freighter Deployment.....	G14.73
Lab G4.0.....		Proximity Fuse (Photon).....	E4.3	Sublight Tactical Maneuvers, TAC.....	C5.1
Landing on Planets.....	P2.4	Pseudo speed.....	C2.413, C2.46	Swivel Mounts.....	D2.34, D2.36, FP3.2
Landing on (or Docking to) Asteroids.....	P3.42	Pseudo-Plasma.....	FP6.0	T-Bomb.....	MP6.0
Large Asteroids.....	P3.4	Pseudo-Pod.....	G14.6	Tactical Maneuvers.....	C5.0
Launch Tubes.....	J1.54	Publisher's Information.....	Z0.0	Taking Off From Planets.....	P2.412
Leaky Shields.....	D3.6	Pulling Enemy Shuttle Into Bay.....	G7.8	Task Force Games.....	Z6.1
Legal Speed Plot.....	C1.341	Pulsar.....	P5.0	Tholian Ships.....	R7.0
Levels of Victory.....	S2.3	Pursuit Plotting.....	C1.322	Tholian Web.....	G10.0
Life Support.....	B3.3	Q-Ships.....	R1.7	Towing.....	G7.32
Loaning EW Points.....	D6.392, J4.93	Quick Reverse.....	C3.6	Tractor Auction.....	G7.414, G7.42
Local Conditions.....	S5.0	Range.....	D1.4	Tractor Beams.....	G7.0
Lock-On.....	D6.11	Ready Rack.....	J4.822	Tractor Beams, Gravity Landing.....	P2.432
Low-Power Fire Control.....	D6.7	Repair of Damage.....	D9.0	Tractor Beams, Ground Bases.....	P2.712
Maneuver Rate.....	C2.414, C2.42	Reserve Impulse Power.....	H7.47	Tractor Beams, Raising and Lowering.....	P2.44
Marines.....	D7.0	Reserve Power.....	H7.0	Tractor, Multi-Engagements.....	G7.37
Mech Links, shuttles.....	J1.56	Reserve Power, Contingent.....	H7.6	Tractor, Negative.....	G7.35
Medium Ground Bases.....	P2.76	Reserve Warp Power.....	H7.4	Tractor, Rotation.....	G7.7
Mines.....	M0.0	Reversing Direction.....	C3.5	Transporter Bombs.....	M3.0
Mines, Arming.....	M2.3	Rings, Planetary.....	P2.223	Transporter Bombs, Availability.....	M3.13
Mines, Detonating.....	M2.4	Rolling Delay.....	FP1.91, G5.21	Transporters.....	G8.0
Mines, Dummy.....	M2.9	Romulan Ships.....	R4.0	True Carrier.....	J4.61
Mines, Hidden.....	M2.6	Rotation (of Bases).....	C3.7	True Range.....	D1.4
Mini-Campaigns.....	T0.0	Rotation (via Tractor).....	G7.7	Tugs and Pods.....	G14.0
Miniatures.....	A1.2, W0.0	Rules Organization.....	A3.1	Tumbling.....	C6.55
Minimum Crew.....	G9.4	Scale.....	A3.4	Turn Modes.....	C3.2
Mizia Attack.....	Z2.0	Scanners.....	D6.2	Turn Modes, Directed.....	C3.8
Modified Victory Conditions.....	S2.201	Scenarios.....	S0.0	Turning.....	C3.0
Modifying Ships.....	S3.3	Scenarios, Captain's Log.....	SL0.0	Two-Turn F.....	FP1.93
Modules.....	R0.6	Scenarios, General.....	SG0.0	Ubitron Interface Module.....	D6.5
Monster Close-In Defense System.....	E6.0	Scenarios, Historical.....	SH0.0	Uncontrolled.....	G2.2
Monsters.....	S6.0, SM0.0, Annex #12	Scenarios, Nexus Magazine.....	SN0.0	Undermanned.....	G9.41
Moons.....	P2.23	Scenarios, Patrol.....	S8.0	Variable Pulsar.....	P5.0
Movement.....	C0.0	Scenarios, Special Rules.....	S1.3	Victory Points.....	S2.2
Movement, Energy Cost of.....	C2.0	Scientific Infor.....	G4.1, G5.2, S6.0, SM0.0	Volley.....	D4.22, G7.81
Movement, Seeking Weapons.....	F2.0	Security Stations.....	G6.0	Warp Energy.....	H2.0
Mutiny.....	G6.0	Seeking Weapons.....	F0.0	Warp Engines.....	H2.0
Narrow Salvoes.....	E1.6	Seeking Weapons, Continuous Tracking.....	F2.6	Warp Tactical Maneuvers.....	C5.2
Nebulae.....	P6.0	Seeking Weapons, Expended or Inert.....	F1.7	Weapons Status.....	S4.0
Negative Tractor.....	G7.35	Seeking Weapons, Guidance.....	F3.0	Web Anchor.....	G10.13
Non-violent combat.....	D6.4	Seeking Weapons, Identifying.....	G4.2, G5.25, J2.15	Web Spinner.....	G10.24
Nuclear Space Mines.....	M2.0	Seeking Weapons, Movement.....	F2.0	Web, Pulling a Ship Out of.....	G10.56
OAKDISC.....	FD4.5	Seeking Weapons, Secret Targeting.....	F3.6	Web, Tholian.....	G10.0
Option Mounts.....	G15.4, R8.R3	Seeking Weapons, Types of.....	F1.0	Wild Weasels.....	J3.0
Order of Precedence.....	C1.313	Self-Destruction.....	D5.0, J1.83	Winning, How to.....	S2.0
Orders of Battle.....	Annex #7C	Sensors.....	D6.1	WYN Radiation Zone.....	P7.0
Orion Cartels.....	G15.9, R8.1	Sequence of Play.....	B2.0, Annex #2	Y175 Refits.....	R2.R4, R3.R4, R5.R5, R8.R2
Orion Engine Doubling.....	G15.2	Shields.....	D3.0	Zero Energy Turn.....	C5.13
Orion HET Bonus.....	C6.521	Shields, Dropping.....	D3.5		
Orion Pirate Ships.....	R8.0	Shields, Minimum.....	D3.33		
Orion Pirate Special Rules.....	G15.0	Shields, Reinforcing.....	D3.34		
Pallets (Tugs).....	G14.0	Ship System Displays.....	R0.2, R0.8		
Patrol Scenarios.....	S8.0	Ships, Crippled.....	S2.4		
Phaser Capacitors.....	H6.0	Ships, Definitions of Terms.....	R0.6		
Phasers.....	E2.0	Shuttle Bays.....	J1.51		
Photon Torpedoes.....	E4.0	Shuttlecraft.....	J0.0		
		Shuttlecraft, Capturing.....	D7.6		

**ANNEX #2 SEQUENCE OF PLAY FOR BASIC SET**

This sequence of play lists almost every action that can be taken during the turn, in the EXACT order that they occur. These actions must be taken in the SPECIFIC order listed here.

**1. ENERGY ALLOCATION PHASE**

Tractor/Negative-tractor auction (G7.42).  
All players allocate energy in accordance with the rules (B3.0).  
Allocate damage control efforts (D9.2) and (D9.7).  
Plot Self-Destruction (D5.1).  
Orions announce if they are doubling their engine output (and which engines); see (G15.2).  
Announce if shields were unpowered; if so, shields cease to function at this point (D3.52).  
Announce Self-Destruction (D5.1).

**2. SPEED DETERMINATION PHASE**

All players announce their speeds (B2.3 #2).  
The Controller prepares his charts (C1.44).

**3. SELF-DESTRUCTION PHASE**

Resolve self-destruction by units plotted to do so (D5.0). See also (D7.7) for the possibility that enemy marines on board could prevent self-destruction.

**4. SENSOR LOCK-ON PHASE**

All players secretly assign alternative ECM/ECCM strength (EWP swing points, etc).  
All players secretly assign all lending of EW that is to be in effect at the start of the turn under the provisions of (J4.9).  
Announce ECM and ECCM strength (D6.32) including loaning.  
All players determine if they have a lock-on to targets (D6.11).  
Attempt to re-acquire lock-on to cloaked units (G13.333).

**5. INITIAL ACTIVITY PHASE**

Tractor Rotations Step (G7.7).  
Assign boarding parties as guards (D7.83).  
Roll for variable pulsar outburst (P5.11) & (P5.12).  
Attempt to destroy cloaking device (G13.163).  
Begin inter-bay shuttle (J1.59) and deck crew (J4.813) transfers.  
Reload Assignment Step: Take drone racks (FD2.42) out of service for reloading or unloading.

**6. IMPULSE PROCEDURE (Repeat for each impulse.)****6A. MOVEMENT SEGMENT****6A1: INVOLUNTARY MOVEMENT STAGE**

Move playing pieces in accordance with black hole rules (P4.1).  
Movement caused by nebula (P6.5) on Impulses #5, #15, #26.

**6A2: VOLUNTARY MOVEMENT STAGE**

Declare direction for accumulation of Directed Turn Mode (C3.81).  
Determine which playing pieces will move in this impulse (C1.4).  
Move those playing pieces scheduled to move in accordance with the rules. See (C1.31). This will include base rotations on certain impulses (C3.7). This may include, on Impulse #32 only, landing on or taking off from a planet (P2.41) or atmospheric flight (P2.8). Determine, but do not resolve, any damage caused by movement.

**6A3: DAMAGE DURING MOVEMENT STAGE: In each of the following steps, allocate the damage (D4.0) as it is resolved, step by step.**

Resolve damage from enveloping plasma torpedoes (FP5.3).  
Resolve damage from seeking weapons not resolved above (F2.3).  
Resolve damage from asteroids (P3.2) dust, and rings (P2.223).  
Determine any collisions with planets (P2.212) or moons (P2.23). Resolve any crash landings (P2.431) or catastrophic landings (P2.435). Web deceleration (G10.59).

Resolve damage from mines (M0.0).  
Resolve explosions from destroyed units (D5.0) (if any).  
Roll for possible critical hits (D8.0).  
Resolve breakdowns (C3.61), (C6.54), (G7.3222).

**6A4: FINAL MOVEMENT ACTIONS STAGE**

Release ships from tractor beams (G7.0) if these systems were destroyed in this segment.  
Announce movement changes: intention to adopt/drop pursuit (C1.322), evasion (C1.3223), or station keeping plotting (C1.3224); Tholian units forgo or resume web passage status (G10.533). These decisions are made secretly and simultaneously in advance of all announcements in this step.  
Emergency Deceleration takes effect (C8.0).

**6B. IMPULSE ACTIVITY SEGMENT****6B1: INITIAL STAGE**

Resolve damage from pulsar outburst (if outburst occurs) (P5.2).  
Switch fire control from active (D6.6) to inactive mode (D6.614) or vice versa or from full power to low-power (D6.7). This is the time for voluntary changes; involuntary changes [e.g., wild weasel (J3.0), cloak (G13.0)] occur as required at other points (D6.63).

**6B2: CLOAKING DEVICE STAGE**

Activate (G13.14) or deactivate (G13.15) cloaking device.  
Announce range and bearing if using hidden movement of cloaked ships (G13.61) on Impulses #8 and #24.  
Attempt to destroy own cloaking device (G13.162). This can only be attempted once in any period of 32 impulses.

**6B3: LOCK-ON STAGE**

Roll to determine if lock-on has been lost, retained, or regained due to changing conditions (D6.1). Note that this may be repeated several times during the impulse if conditions (particularly cloaked ships and WW) change. This is also the point at which self-controlled ATG and warp-seeking drones which are beyond tracking range of their targets lose tracking, and the point at which the conditions of (F3.31) are judged.

Carriers use reserve power to increase EW for lending (H7.2).  
Fighters make voluntary changes as to which EW source they are accepting lending from (J4.922).

Determine disengagement by separation (C7.21).

**6B4: SHIP SYSTEM FUNCTIONS STAGE**

Reinforce web; recalculate strength (G10.3).  
Web Step: Lay web (G10.23). Assume or drop web anchor status (G10.116).

Operate Tractors: Activate or release tractor beams (G7.0). This is the only time for voluntary activation or release; involuntary release may occur at various points (destruction of tractor, launch of WW, etc.). This could result in an immediate tractor auction (G7.414).

Attach pods to a tug (G14.4). (Pods are dropped in 6B10.)  
Labs (G4.2) attempt to identify seeking weapons.

**6B5: SCOUT FUNCTIONS STAGE (See Advanced Missions.)****6B6: SEEKING WEAPONS STAGE**

SW Control Step: Voluntary transfers (F3.5) or release (F3.4) of control of seeking weapons. Involuntary transfers and releases can occur at many other points in the sequence; see (F3.53).

Drop electronic warfare pods (J4.9622).  
Launch plasma torpedoes (FP1.3) and/or PPTs (FP6.12).  
Launch drones (FD1.2).  
Launch probes (for information, not as weapon) (G5.2).

**6B7: MARINES ACTIVITY STAGE**

Mutiny Step: First die roll for mutiny (G6.20).  
Operate Shields Step: Drop shields; restore shields dropped previously (D3.5).  
Operate transporters (G8.0), including the laying of T-bombs (M3.22). Block boarding by (G8.23). Resolve "hit-and-run" raids (D7.8) conducted by transporter.  
Reactive guard assignments are made (D7.86).  
Mines laid 2 impulses previously by transporter (M3.22) become active if the laying ship is out of detonation range (M3.32).

**6B8: SHUTTLE FUNCTIONS STAGE**

Recover (land) shuttlecraft (J1.6), fighters. Shuttles land on enemy ships (J1.63) and (J1.65).

Release of (J1.34) restrictions (after appropriate delay) for previously-launched shuttles.  
 Launch shuttlecraft (J1.5), fighters WWs (J3.0), and suicide shuttles. Involuntary release of tractor beams to allow wild weasel launch (J3.452) may be a part of this action.  
 Move shuttles between shuttle bay and balcony (J1.53).  
 Deck Crew Actions Step (J4.817). Record deck crews which begin or finish actions and incremental progress on assigned actions.

6B9: SATELLITE SHIP FUNCTIONS STAGE (See Module C2.)

6B10: SEPARATIONS STAGE

Drop pods from a tug (G14.3).  
 Lay mines (other than by transporters) (M2.1).  
 Mines laid in previous impulses become active if the conditions of (M2.34) are satisfied.

6B11: FINAL FUNCTIONS STAGE

Announce emergency deceleration (C8.0).  
 Roll to determine new facing of tumbling ships (C6.5511). If this is the last tumbling impulse, see (C6.554).

6C. DOGFIGHT RESOLUTION INTERFACE (See Module J.)

6D. DIRECT-FIRE WEAPONS SEGMENT

6D1: FIRE ALLOCATION STAGE

Fire Decision Step: All players secretly and simultaneously decide what direct-fire weapons to fire and the targets of those weapons. At this point, EW points being generated can be adjusted under (D6.315) by reserve power or various other means. (Note that lending of EW to fighters is adjusted in 6B3.)  
 Fire Declaration Step: All direct-fire weapons fire is announced, including specific weapons and targets. Changes to EW levels under (D6.315) are also announced.

6D2: DIRECT-FIRE WEAPONS FIRE STAGE: *General note:*

*Weapons are fired in the specific order given. Resulting internal damage is not resolved until the Damage Resolution Stage. At the points marked "§", reserve power may be used under (H7.134) to mitigate damage.*

Direct-Fire Step: All Direct-Fire Weapons fire. Shield damage is marked§; internal damage is recorded to be resolved later (E1.11) in 6D4.

6D3: WEB CASTER STAGE (See Module C2.)

6D4: DIRECT-FIRE WEAPONS DAMAGE RESOLUTION STAGE

Allocate the internal damage from all direct fire weapons above (D4.0). Note that a weapon destroyed in the first of the many various firing steps would still be able to fire (if allocated to do so) in its appropriate later step in the same impulse because no damage is resolved until this point.

6D5: DIRECT-FIRE WEAPONS CONSEQUENCES STAGE

Resolve explosions (D5.0) from destroyed units (if any) (D4.4), then repeat stage 6D4. (No weapons are fired; this is used to resolve any damage resulting from the explosions. Battery power can be used to mitigate shield damage.)

Roll for possible critical hits (D8.0).

Release ships from tractor beams (G7.0) if these systems were destroyed in this segment.

Electronic warfare (D6.3) benefits of any systems destroyed in Segment D are lost (e.g., carrier destroyed, etc.)

6E. POST-COMBAT SEGMENT

Roll for the possibility of UIM breakdown (D6.52).

Deploy Reserve Power for "delayed uses" under (H7.132).

END OF IMPULSE PROCEDURE

Return to start of Impulse Procedure and repeat until all 32 impulses have been completed.

**7. FINAL ACTIVITY PHASE**

Roll for mutiny (G6.20).

Resolve boarding party combat (D7.4), (D7.63).

Roll for critical hit repair (D8.3).

Disengage by acceleration (C7.1) or evasion (C7.3).

**8. RECORD KEEPING PHASE**

8A: REPAIR STAGE

Mark and announce repairs completed (D9.73).

Resolve repair of shields by damage control (D9.2).

Move reserve power to phaser capacitors (H7.36).

8B: POWER ABSORBER ACCOUNTING STAGE (See Module C2).

8C: FINAL RECORDS STAGE

Orions record loss of engines from double output (G15.2).

Determine information from labs based on closest approach to the monster (or other object of study) (G4.12).

Record drone racks (FD2.42) which were reloaded or unloaded.

Anti-drones that were not fired (E5.74) on the current turn are reloaded automatically unless player orders otherwise.

Complete inter-bay shuttle (J1.593) and deck crew (J4.813) transfers.

END OF TURN. Begin a new turn at the start of the sequence.

**ANNEX #3A: TUG MOVE COSTS & TURN MODES**

TUG CLASS	0 PODS	1 POD	2 PODS	3 PODS
Federation	1 D	1 D	1.5 E	2.0 F

NOTE: The number of pods is the total equivalent weight. Some pods are "double weight." No tug can carry three pods.

**ANNEX #5 ABBREVIATIONS**

- + (Plus) ..... Improved or refitted
- A HULL ..... Aft Hull, same as Rear Hull
- ADB ..... Amarillo Design Bureau
- ADD ..... Anti-Drone Defense system
- Admin ..... Administrative Shuttle
- AFC ..... Active Fire Control
- Allosaurus ..... Gorn CA
- APR ..... Auxiliary Power Reactor
- AS ..... Kzinti Attack Shuttle
- AAS ..... Kzinti Advanced Attack Shuttle
- ATG ..... Active Terminal Guidance
- AUX ..... Auxiliary Control
- AWR ..... Auxiliary Warp Reactor
- AxCVL ..... Small Auxiliary Carrier
- BATS ..... Battle Station
- BC ..... Battlecruiser
- BDG ..... Bridge
- BES ..... Basic Explosion Strength
- BP ..... Battle Pod
- BP ..... Boarding Party
- BPV ..... Basic Point Value
- BRDG ..... Bridge
- BS ..... Base Station
- BT ..... Battle Tug
- BTTY ..... Battery
- C8 ..... Klingon Dreadnought
- C9 ..... Klingon Dreadnought
- CA ..... Heavy Cruiser
- CAR ..... Federation Heavy Cruiser with rear phaser refit
- Carnosaurus ..... Gorn DD
- CC ..... Command Cruiser
- C HULL ..... Center Hull
- C WARP ..... Center Warp Engine
- CDR ..... Continuous Damage Repair
- CGO ..... Cargo
- CL ..... Light Cruiser
- CL# ..... Captain's Log (issue #)
- CR ..... Orion Raider Cruiser, essentially a CL
- CS ..... Strike Cruiser
- CV ..... Carrier
- CVS ..... Strike Carrier
- D7 ..... Klingon Battlecruiser
- D6 ..... Older type of Klingon Battlecruiser
- DAC ..... Damage Allocation Chart
- DAM CON ..... Damage Control
- DC ..... Damage Control
- DC ..... Deck Crew
- DD ..... Destroyer
- DERFACS ..... Disruptor Extended Range Fire Attenuation Control System
- DF&E ..... Deluxe edition of Federation & Empire

DFC.....Disrupted Fire Control  
 DFW.....Direct-Fire Weapons  
 DISR.....Disruptor bolt  
 DN.....Federation Dreadnought  
 DRN.....Drone  
 DSF.....Deep Space Fleet (Klingon)  
 E4.....Klingon Escort  
 EA.....Energy Allocation  
 EAF.....Energy Allocation Form  
 ECCM.....Electronic Counter-Counter Measures  
 ECM.....Electronic Countermeasures  
 ED.....Emergency Deceleration  
 EFF.....Carrier escort variant of FF  
 EM BRIDGE.....Emergency Bridge  
 EMER BRIDGE.....Emergency Bridge  
 EMER.....Emergency Bridge  
 Emer Decel.....Emergency Deceleration  
 ENG.....Engine  
 EPT.....Enveloping Plasma Torpedo  
 EW.....Electronic Warfare  
 EWF.....Electronic Warfare Fighter  
 EWP.....Electronic Warfare Pod  
 EX DAM.....Excess Damage  
 F5.....Klingon Frigate  
 F.....Fast drone, as in Type-IV-F  
 F.....Forward (in hull box)  
 F.....Freighter  
 F-?.....Large or small freighter  
 F-L.....Large freighter  
 F-S.....Small freighter  
 F HULL.....Forward hull  
 F&E.....Federation & Empire  
 F&E-89.....Deluxe F&E  
 F-torp.....Type-F Plasma torpedo  
 FA.....Forward firing arc  
 FF.....Frigate  
 FH.....Front Half firing arc  
 FLAG.....Flag Bridge, admiral's bridge  
 FP.....Front Plasma swivel firing arc  
 FX.....Forward expanded firing arc  
 G-torp.....Type-G Plasma torpedo  
 GCS.....Gorn Confederation Ship  
 GLS.....Gravity Landing System  
 GP.....Galactic Powers  
 H&R.....Hit-and-Run, Hit-and-Run Raid  
 HET.....High Energy Turn  
 HBM.....Hangar Bay augmentation Module  
 HWS.....Heavy Weapon Squad  
 IKV.....Imperial Klingon Vessel  
 IMP.....Impulse Engine  
 ISF.....Internal Security Forces (Klingon)  
 KR.....Romulan conversion of Klingon D6  
 K5R.....Romulan conversion of Klingon F5  
 L.....Left (e.g., warp engine, etc.)  
 L.....Left firing arc  
 L WARP.....Left Warp Engine  
 LF.....Left forward firing arc  
 LP.....Left Plasma swivel firing arc  
 LPR.....Left Plasma Rear swivel arc  
 LR.....Left Rear Firing Arc  
 LS.....Left Side firing arc  
 M.....Medium-speed drone, as in Type-I-M  
 MCIDS.....Monster Close-In Defense System  
 Megalosaurus.....Gorn CL  
 Mod.....Modified, Modifier  
 MSC.....Master Ship Chart (Annex #3)  
 NCC.....Naval Construction Contract  
 NSM.....Nuclear Space Mine  
 NT.....Negative Tractor  
 NVC.....Non-Violent Combat  
 OAKDISC.....Orion Advanced Killer Drone Improved System of Control  
 OPC.....Orion Pirate Cruiser  
 OPT.....Option Mount  
 P-B.....Battle Pod  
 P-BP.....Battle Pod  
 P-C.....Cargo Pod

P-CP.....Cargo Pod  
 P-SL.....Federation Starliner Pod  
 PC.....Patrol Corvette  
 PFC.....Passive Fire Control  
 PHOT.....Photon Torpedo  
 PH-1, Ph-1.....Phaser-1, sometimes P1  
 PH-2, Ph-2.....Phaser-2, sometimes P2  
 PH-3, Ph-3.....Phaser-3, sometimes P3  
 PH-4, Ph-4.....Phaser-4, sometimes P4  
 PH-G, Ph-G.....Gatling Phaser, sometimes PG  
 PL.....Plasma torpedo  
 PL-F, Plas-F.....Type-F Plasma torpedo  
 PL-G, Plas-G.....Type-G Plasma torpedo  
 PL-R, Plas-R.....Type-R Plasma torpedo  
 PL-S, Plas-S.....Type-S Plasma torpedo  
 PLAS.....Plasma torpedo  
 PPT.....Pseudo-Plasma Torpedo  
 PRB.....Probe  
 Prox.....Proximity  
 PsuPod.....Pseudo Pod  
 Q-Ship.....Ship designed to ambush raiders  
 Q-S.....Ship designed to ambush raiders  
 Q-SL.....Large Q-Ship  
 Q-SS.....Small Q-Ship  
 R HULL.....Rear Hull, same as Aft Hull  
 R.....Rear when part of hull  
 R.....Right firing arc  
 R.....Right, e.g., warp engine, etc.  
 R WARP.....Right Warp Engine  
 R-torp.....Type-R Plasma torpedo  
 RA.....Rear firing arc  
 REP.....Repair  
 RF.....Right Front firing arc  
 RH.....Rear Half firing arc  
 RP.....Right Plasma swivel firing arc  
 RPR.....Repair, see also REP  
 RPR.....Right Plasma Rear swivel arc  
 RR.....Right Rear firing arc  
 RS.....Right Side firing arc  
 RWP.....Reserve Warp Power  
 RX.....Rear expanded firing arc  
 S.....Slow-speed drone, as in Type-I-S  
 S-torp.....Type-S Plasma torpedo  
 SB.....Starbase  
 SC.....Scout  
 Scout.....Electronic Warfare Support Variant  
 SCRTY, SCTY.....Security station  
 SEN.....Special Sensor, Scout Sensor  
 SFB.....Star Fleet Battles  
 SG#.....Scenario, General  
 SGSW.....Self-Guided Seeking Weapon  
 SH#.....Scenario, Historical  
 SHTL.....Shuttlecraft  
 SHTTL.....Shuttlecraft  
 SL.....Starliner  
 SL#.....Scenario, Captain's Log  
 SM#.....Scenario, Monster  
 SN#.....Scenario, Nexus magazine  
 SP#.....Scenario, Playtest  
 SPEC SEN.....Special Sensor, Scout Sensor  
 SS.....Suicide Shuttle  
 SSD.....Ship's Systems Display  
 Std.....Standard  
 SW.....Seeking Weapons  
 T-Bomb.....Transporter Bomb  
 TAC.....Tactical maneuver  
 TB.....Transporter Bomb  
 TFG.....Task Force Games  
 TG.....Tug  
 TORP.....Torpedo (photon, plasma, or discr.)  
 TRAC.....Tractor beam  
 TRAN, TRANS.....Transporter  
 Tug.....Ship that carries pods  
 UIM.....Ubitron Interface Module  
 USS.....United (Federation) Star Ship  
 W EN.....Warp engine

W#.....Weapon # (W1, W2, etc) on generic SSDs to denote weapons.  
 War Eagle.....Warp-powered version of Warbird  
 WARP.....Warp Engine  
 WB.....Warbird  
 Warbird.....Old Romulan sublight cruiser  
 WE.....Romulan War Eagle; old series cruiser  
 WEB.....Web generator (Tholian)  
 WER.....Romulan War Eagle with rear phaser refit  
 WPN.....Weapon  
 WS-?.....Weapon Status  
 WW.....Wild Weasel

**ANNEX #6 COMMANDER'S OPTIONS**

**WEAPON OR FUNCTION.....VALUE**

**AMMUNITION, SYSTEMS, CREW**  
 Each transporter bomb (limited by M3.1) ..... 4  
 One NSM on New (M2.74) or KR (M2.73) Rom ship ..... 8  
 Asteroid for web anchor point.....25§  
 Extra UIM Module.....5  
 Refits available but not installed .....Varies  
 Extra boarding party (limit 10).....0.5  
 Each extra deck crew (limit 4, carriers only).....0.5  
 Replace fighter with 2-seat non-EW fighter.....2.0  
 Each extra EW pod stored for fighters.....1.0  
 § Normally purchased as a unit, not an option.

**DRONES**

Replace one type-I drone with one type-II.....0.5  
 Replace one type-I drone with one type-III drone (speed 8).....0.5  
 Replace one type-I drone with one type-III drone (speed 12)....1.0  
 Replace 2 type-I drones with 1 type-IV drone.....0.0  
 Replace 2 type-I drones with 1 type-V .....0.5  
 Replace 1 type-I drone with two ADDs on G-rack.....0.0  
 Replace ADD with type-VI drone (E5.41).....0.25  
 Add active terminal guidance to a drone.....0.5  
 Improve one drone to speed-M.....0.5  
 Improve one drone to speed-F.....1.0  
 Improve one drone to extended range.....0.5  
 Each extra type-I drone .....1.0  
 Each extra type-III drone (speed 12).....2.0  
 Each extra type-IV drone.....2.0  
 Each extra type-VI drone.....0.5  
 Each extra ADD round.....0.25  
 See also (FD2.11) for some specific exchange costs.

**ANNEX #7: DATA ON SHIPS**

**ANNEX #7A COLOR OF COUNTERS**

RACE	SHIP	BACKGROUND
General.....	Blue.....	White
Federation.....	Black.....	Blue
Klingon.....	White.....	Black
Romulan.....	Black.....	Red
Kzinti.....	Black.....	White
Gorn.....	Red.....	White
Tholian.....	White.....	Red
Orion.....	White.....	Blue

**ANNEX #7B SHIPS ABLE TO LAND ON PLANETS**

Various ships in the game can land on planets by various systems. See (P2.43) for details and instructions.  
**GRAVITY:** The following ships can use the Gravity Landing System: Orion CR, Tholian PC, Tholian PC+.  
**AERODYNAMIC:** The following ships can use the Aerodynamic Landing System: Romulan WB, WE; Orion CR all fighters.  
**ENGINE:** The following ships can land under engine power: All ships capable of aerodynamic landings; all shuttles.  
**BONUS:** All ships that can land under engine power receive the 1-5 bonus for crash landing (P2.431).

**ANNEX #7C FLEET ASSIGNMENTS**

Order of Battle data (lists of how many ships are in each fleet) has been transferred to the game *FEDERATION & EMPIRE*.

**ANNEX #7D SYSTEMS DEFINED AS "WEAPONS"**

**ALWAYS:** The following systems are always defined as weapons: anti-drone systems, disruptors, drone racks, phasers, photon torpedoes, plasma torpedoes.  
**CONDITIONAL:** The systems listed below are considered weapons for purposes of the rule noted in addition to the above:  
 (C6.547) Recovery from breakdown: probe, web generator.  
 (D4.21) Damage Allocation: "Any Weapon": Any listed anywhere in Annex #7D, any shuttle (D4.324).  
 (D7.55) Any item listed anywhere in Annex #7D except shuttles; see (D7.541).  
 (D9.43) Repair: See (D6.522) for UIMs.  
 (G6.511) Mutiny: probe, shuttlecraft, fighter.  
 (S2.41-E) Crippled ships: web.

**ANNEX #7E DAMAGE CONVERSION CHART**

**HIT FROM CHART.....SCORED ON**  
 Aft Hull.....C Hull, Repair, shuttles on balconies (J1.531) must be hit first.  
 Any Weapon.....See Annex #7D, (D4.21).  
 APR.....AWR on ships and starbases.  
 C Warp.....AWR on bases other than starbases (H4.32).  
 Cargo.....Repair, ship in Starbase docking module (R1.1D).  
 Drone†.....ADD systems.  
 Excess Damage.....Cargo, Repair.  
 Flag Bridge.....Security Station, web generator.  
 Forward Hull.....C Hull, Repair.  
 Phaser†.....various types; see (D4.321).  
 Shuttle.....Fighter.  
 Torpedo†.....Disruptors, plasma torpedo, photon.  
 †.....Subject to Damage Priority Rule.  
 Special sensor hits may be scored on weapon hits which are scored on the weapon which the special sensor replaced. This varies from ship to ship; see the individual ship SSDs or their descriptions.

**DAMAGE PRIORITY RULE**

**(D4.3221) PHASERS:** For the purposes of this rule, the priority (for establishing the best type of phaser) is: special sensors that replaced phasers, phaser-4, phaser-1, phaser-G, phaser-2, phaser-3.  
**(D4.3222) TORPEDOES:** For the purposes of this rule, the priority (for establishing the best type of torpedo) is: special sensor replacing torpedo, plasma-R, plasma-S, photon, plasma-G, disruptor (in order from greatest range to shortest), plasma-F.  
**(D4.3223) DRONES:** For the purposes of this rule, the priority (for establishing the best type of weapon destroyed on a drone hit) is: special sensor replacing drone-weapon, magazine of D-rack, magazine of H-rack, G-rack, B-rack, C-rack, E-rack, F-rack, A-rack, starbase ADD, ADD-12, ADD-6.

**ANNEX #7G: CARRIER INFORMATION**

Race	CV	Ftrs	Admin	Bays	Store	DC
Kzinti	CVS	12	3	1	150	12
	CV	12	3	1	150	12
All	AxCVL	12	3	1	R1.13	12

This chart shows the number of fighters, administrative shuttles, and bays that each of the listed ships has. DC indicates the number of deck crews.



**ANNEX #7L: UNIT TOWING COSTS**

Base Augmentation Modules.....	0.2500
Base with active stabilizers.....	∞
Planet Crusher (SM1.0).....	12.0000
Pods, Federation double-weight.....	0.6667
Pods, Federation single-weight.....	0.3333
Pseudo-Pod.....	0.1000
Romulan Warbird.....	1.0000

**ANNEX #7P SYSTEMS AFFECTED BY SCANNERS**

- (D6.124) No additions at this time.
- (D6.23) Special (scout) sensors.
- (D6.37) No additions at this time.
- (D6.371) No additions at this time.
- (D6.623) No additions at this time.
- (D6.43) No additions at this time.

**ANNEX #8: WEAPONS DATA**

**ANNEX #8A DISRUPTOR RANGE TABLE**

In the Captain's Edition, all ships have an SSD and the range of the disruptors (on those ships armed with that weapon) is shown on that SSD. This table is now used only for some special cases.

RACE	SHIP	DISRUPTOR RANGE
All	Base Station (BS)	30
All	Battle Station (BATS)	30
All	Q-ships	22
All	Starbase (SB)	40
Orion	Option Mount	See Annex #8B

**ANNEX 8B: ORION PIRATE OPTIONAL WEAPONS COST CHART**

WEAPONS OR SYSTEM	COST	NOTES
ADD (6 round).....	0	
ADD (12 round).....	1	
APR.....	0	
Aux.....	0	Δ
AWR.....	0	
Battery.....	0	
Cargo.....	0	
Cloak.....	See G15.3	
Disruptor-15.....	-1	†
Disruptor-22.....	0	
Disruptor-30.....	1	‡
Disruptor-40.....	2	‡
Drone Rack A.....	0	
Drone Rack B.....	1	
Drone Rack C.....	1	
Drone Rack E.....	1	
Drone Rack G.....	2	
Hull.....	0	Δ
Lab.....	0	
Phaser-1.....	0	
Phaser-2.....	-0.25	†
Phaser-3.....	-0.50	†
Phaser-4.....	NA	∞
Phaser-G.....	2	
Photon Torpedo.....	0	
Plasma-F Torp (No Swivel).....	0	
Plasma-F Torp (Swivel).....	1	
Plasma-G Torp (No Swivel).....	1	*
Plasma-G Torp (Swivel).....	2	*
Plasma-R.....	NA	∞
Plasma-S Torp (No Swivel).....	4	*‡
Plasma-S Torp (Swivel).....	7	*‡
Probe Launcher.....	0	
Tractor Beam.....	0	
Transporter.....	0	Δ

\* Requires two adjacent centerline optional mounts or two adjacent WYN hull side mounts.  
 ∞ Orions can never, under any circumstances, have this weapon.  
 † These weapons reduce BPV of ship.  
 ‡ Cannot be used on size-4 or smaller ship.  
 Δ Cannot be used in Orion wing mounts.  
 Orions cannot use Tholian technology.  
 Weapons with ammunition (e.g., drone racks) are fully loaded at no extra cost (drone speed upgrades must be paid for).  
 Some other items or systems are available for purchase under various rules but do not use option mounts. These include DERFACS, UIM, cloaks, OAKDISC.  
 Orion disruptors with ranges more than 22 include DERFACS from Y168 (E3.62). Orion ships with range-22 or greater disruptors can acquire UIMs from Y166 for 5 points each.

**ANNEX #9 COST OF REPAIR CHART**

SYSTEM.....	REPAIR COST
ADD (6 round).....	3
ADD (12 round).....	4
APR 4	
Armor.....	2†
AWR.....	6
Battery.....	2
Bridge (any control).....	6
Cargo.....	1
Dam Con (per point).....	3†
Damage point on fighter or shuttle.....	1
DERFACS.....	4
Disruptor: range 10.....	4
Disruptor: range 15.....	5
Disruptor: range 22.....	7
Disruptor: range 30.....	8
Disruptor: range 40.....	10
Drone rack (any).....	3
Excess Damage.....	D9.44†
Hull.....	1
Impulse Engine.....	5
Lab.....	5
Phaser-1.....	5
Phaser-2.....	4
Phaser-3.....	2
Phaser-4.....	10
Phaser-G.....	6
Photon Torpedo.....	8
Plasma-F.....	5
Plasma-G.....	10
Plasma-R.....	20
Plasma-S.....	15
Probe.....	3
Repair Box.....	6
Scanner (track, per box).....	10
Sensor (track, per box).....	10
Shield (per box).....	2
Shuttle Bay (with ready rack).....	4
Shuttle Bay (without ready rack).....	2
Special Sensors.....	15
Tractor Beam.....	3
Transporter.....	3
Warp Engine.....	10
Web Generator.....	6

† Ship cannot repair this system on itself.  
 Shuttle bay (with ready rack) includes any shuttle box with a ready rack.

**ANNEX #12: MONSTER DATA TABLE**

SCEN	MONSTER	SIZE	TYPE	CONTROL
SM1	Crusher	1	Ship	Automatic
SM2	Amoeba	0	Live	Automatic
SM3	Moray Eel	1	Live	Automatic
SM4	Cloud	0	Live	Automatic

**END OF BASIC SET ANNEXES**

# MASTER SHIP CHART

# STAR FLEET BATTLES

RACE Rule #	Ship Type	G9.0 Crew Unts	D7.0 Brdg Prts	S2.1 BPV	C6.5 Break Down	C2.12 Move Cost	J1.42 Spare Shttl	R0.6 Size Class	C3.3 Turn Mode	Rule Nbr	Year in Srvc	D5.2 Explo Str	Notes
<b>CIVILIAN SHIPS (R1.0)</b>	F-L	2	-	61/18	1-6	0.50	-	4	D	6	120	5	ML
	F-S	1	-	26/12	1-6	0.33	-	4	C	5	120	2	ML
	AxCVL	20	2	75/50	3-6	0.33	0+2	4	C	13A	170	6	ML, V
	PsuPod	-	-	10	-	■	-	4°	-	G14.6	140	0	
<b>BASES (R1.0)</b>	SB	250	50	600	-	■	6	1	-	1	140	54+	
	BATS	100	24	200	-	■	4	2	-	2	130	18+	
	BS	60	12	120	-	■	2	3	-	3	120	11+	
	HBM	7	0	10	-	■	0+1	5°	-	4	165	+0	V
<b>FEDERATION (R2.0)</b>	DN	50	14	180	3-6	1.50	4	2	E	2	167	24	
	CC	45	10	137	5-6	1.00	3	3	D	3	143	18	
	CA	43	10	125	5-6	1.00	3	3	D	4	130	18	
	CL	37	8	98	4-6	0.75	2	3	C	5	120	14	
	DD	20	6	94	3-6	0.50	1	4	C	6	130	12	
	SC	19	6	120/100	3-6	0.50	1	4	C	7	130	10	
	Tug	22	2	88/60	2-6	†	1	3	†	8	135	15	
	BT	50	10	168	2-6	1.50	1	2	E	10	145	25	
	P-SL	4+30	2	48/20	-	Δ	-	4°	-	9	137	+3	
	P-BP	28	8	88/45	-	Δ	-	4°	-	10	145	+10	
	P-CP	0	0	21/15	-	■	-	4°	-	11	135	+0	
	S-Qship	6	4	40	2-6	0.33	-	4	C	R1.7	130	5	ML
	L-Qship	12	8	81	2-6	0.50	-	4	D	R1.7	130	10	ML
<b>KLINGON (R3.0)</b>	C9	62	24	205	3-6	1.50	2	2	D	2	167	29	
	C8	60	24	211	3-6	1.50	2	2	D	3	167	31	
	D7	45	14	121	5-6	1.00	1	3	B	4	135	19	
	D6	44	14	113	5-6	1.00	1	3	B	5	122	18	
	F5	22	8	71	4-6	0.50	-	4	A	6	135	10	
	E4	14	6	55	4-6	0.33	-	4	A	7	121	8	
	S-Qship	5	5	41	2-6	0.33	-	4	C	R1.7	130	6	ML
	L-Qship	10	10	83	2-6	0.50	-	4	D	R1.7	130	11	ML
<b>ROMULAN (R4.0)</b>	KR	40	10	115	5-6	1.00	1	3	B	4	160	17	
	K5R	20	5	78	4-6	0.50	-	4	A	5	160	9	
	WE	20	5	100	5-6	1.00	-	3	D	3	162	13	*
	WB+	15	5	60	-	Δ	-	3	-	2	158	7	*
	WB	15	5	45	-	Δ	-	3	-	2	33	4	*
<b>KZINTI (R5.0)</b>	CV	50	20	147	5-6	1.00	3+3	3	E	6	166	22	V
	CVS	50	20	169	5-6	1.00	3+3	3	E	7	170	22	V
	CC	44	20	135	5-6	1.00	2	3	C	4	147	21	
	CS	40	16	116	5-6	1.00	2	3	C	2	125	19	
	BC	40	16	128	5-6	1.00	2	3	C	3	160	20	
	CL	30	10	84	5-6	0.67	1	3	B	5	122	14	
	FF	20	6	62	5-6	0.33	1	4	A	8	122	9	
	EFF	20	6	65	5-6	0.33	1	4	A	20	168	9	E
<b>GORN (R6.0)</b>	CA	48	16	120	5-6	1.00	3	3	D	2	121	19	
	BC	48	16	160	5-6	1.00	3	3	D	19	175	19	
	CL	32	8	92	4-6	0.67	2	3	D	3	121	14	
	DD	20	6	68	4-6	0.50	1	4	C	4	120	10	
	DDF	20	6	91	4-6	0.50	1	4	C	4	175	10	
	S-Qship	6	5	35	2-6	0.33	-	4	C	R1.7	130	5	ML
	L-Qship	12	10	80	2-6	0.50	-	4	D	R1.7	130	10	ML
<b>THOLIAN (R7.0)</b>	PC	12	6	59	5-6	0.33	1	4	A	2	83	8	
	PC+	12	6	65	5-6	0.33	1	4	A	3	98	8	
<b>ORION (R8.)</b>	CR	20	12	92	6	0.67	2	3	A	2	127	22	

## EXPLANATION OF TERMS

Δ = sublight ship (speed of 1 in SFB); ° = when detached; † = see tug chart; ■ = does not move under own power; \* = Has one NSM in BPV.

CREW: In the case of crew listed as X+Y, the Y figure indicates non-crew passengers.

BPV: Unless otherwise noted in the rulebook, no ship's BPV includes fighters or mines; all include their admin shuttles. Split BPVs are read economic/combat ratings.

SHUTTLES: The Spare Shuttle column is read as: admin shuttles + fighters.

TUGS: If a specific "tug+pod" combination is listed (e.g., Fed BT), the combination factors must be used, NOT the sum of the individual factors. If no combined listing is shown, add the relevant factors. If a Fed Battle Tug has a pod added to it, the BPV of the pod is added to the BPV of the Battle Tug, not as a combination of "Tug plus Battle Pod plus extra pod".

RULE NBR: This is the rule number of the ship description.

YEAR IN SERVICE: Service dates are the beginning of series production. One or more prototypes may have existed 1-2 years previously

NOTES: E = Carrier escort. Never appears except as part of carrier group.

ML = Manuever limitations on acceleration and/or disengagement. See ship description.

V = True carrier able to lend EW to fighters and with the supplies listed in (J4.7).

CLOAK: All Romulan ships in Basic Set include the cloaking device except for freighters and Q-ships. Romulan bases may be equipped with the cloaking device and, if so equipped, must add 15% to their BPV to pay for it. The presence or absence of a cloaking device on any given base is known before the scenario begins (and before the attacking player selects or deploys his forces).

# STAR FLEET BATTLES

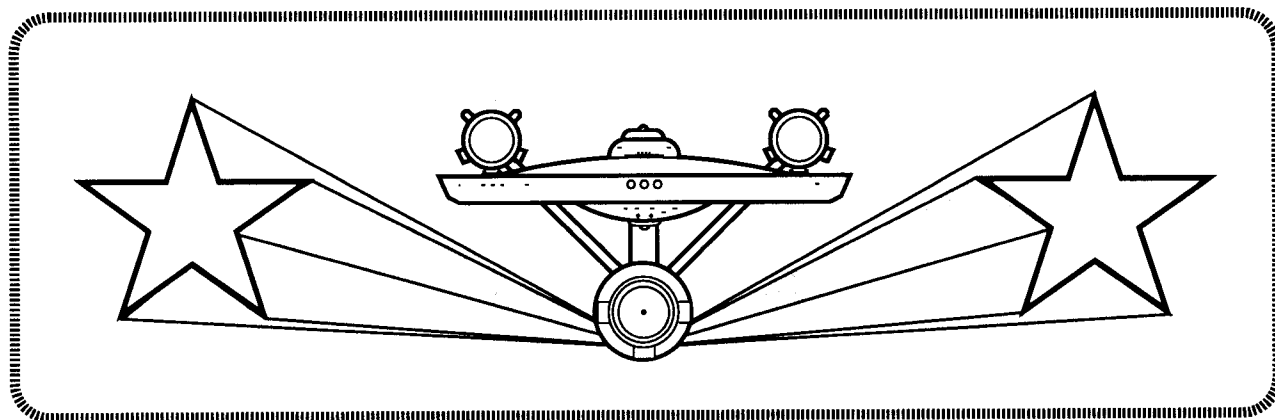

## CAPTAIN'S BASIC SET SSD BOOK 2000



### TABLE OF CONTENTS

RULE #	SSD	PAGE #	RULE #	SSD	PAGE #
<b>GENERAL UNITS</b>			<b>ROMULAN SHIPS</b>		
R1.1	Starbase	24-25	R4.2	Romulan WB	19
R1.2	Battle Station	23	R4.3	Romulan WE	20
R1.3	Base Station	26	R4.4	Romulan KR	21
R1.5	Small Freighter	3	R4.5	Romulan KF5R	22
R1.6	Large Freighter	4			
R1.7	Federation Large Q Ship	5	<b>KZINTI SHIPS</b>		
R1.7	Federation Small Q Ship	6	R5.2	Kzinti CS	33
R1.7	Klingon Large Q Ship	7	R5.3	Kzinti BC	34
R1.7	Klingon Small Q Ship	8	R5.4	Kzinti CC	35
R1.7	Gorn Large Q Ship	9	R5.5	Kzinti CL	36
R1.7	Gorn Small Q Ship	10	R5.6	Kzinti CV	37
R1.13	AxCVL	2	R5.7	Kzinti CVS	38
			R5.8	Kzinti FF	39
			R5.20	Kzinti EFF and Kzinti AFF	40
<b>FEDERATION SHIPS</b>			<b>GORN SHIPS</b>		
R2.2	Federation DN	11	R6.2	Gorn CA	41
R2.3	Federation CC	12	R6.3	Gorn CL	42
R2.4	Federation CA	13	R6.4	Gorn DD	43
R2.5	Federation CL	14	R6.4	Gorn DDF	44
R2.6	Federation DD	15	R6.19	Gorn BC	41
R2.7	Federation SC	16			
R2.8	Federation TUG	17	<b>THOLIAN SHIPS</b>		
R2.10	Federation BT	18	R7.2	Tholian PC	45
R2.9-11	Federation Pods	48	R7.3	Tholian PC+	46
<b>KLINGON SHIPS</b>			<b>ORION SHIP</b>		
R3.2	Klingon C9	27	R8.2	Orion CR	47
R3.3	Klingon C8	28			
R3.4	Klingon D7	29			
R3.5	Klingon D6	30			
R3.6	Klingon F5	31			
R3.7	Klingon E4	32			

# SMALL AUXILIARY CARRIER

CREW UNITS		ADMINISTRATIVE SHUTTLES	
10	20	IDENT	HIT POINTS
			NOTES

BOARDING PARTIES		TRANSPORTER BOMBS	
2		D	D

DECK CREWS	
10	

SHIP DATA TABLE	
TYPE	= AxCVL
POINT VALUE	= 75/50
BREAKDOWN	= 3-6
SHIELD COST	= 1/2+1/2
LIFE SUPPORT	= 1/2
SIZE CLASS	= 4
REFERENCE	= R1.13

TURN MODE	SPEED
C 1	2-4
NO 2	5-9
HET 3	10-14
BONUS 4	15-20
BD 5	21-27
	28+

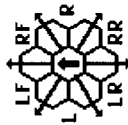

LS = LF + L + LR  
RS = RF + R + RR

ANTI-DRONE TABLE

RANGE	0	1	2	3	4+
HIT#	-	1-2	1-3	1-4	-

THIS SHIP CAN ACCELERATE BY NO MORE THAN 5 MOVEMENT POINTS OR DOUBLE THE CURRENT SPEED. IT CAN DISENGAGE BY ACCELERATION.

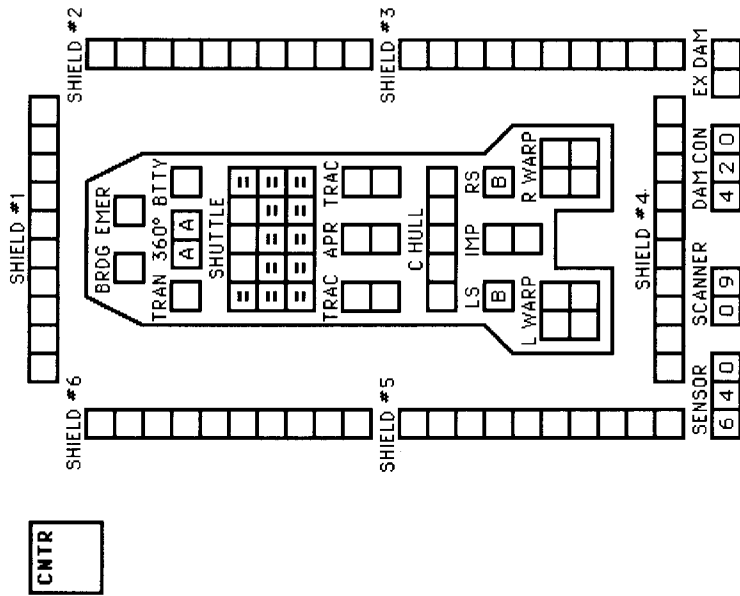

THE WEAPONS USED BY EACH RACE ARE SPECIFIED IN (R1.13).

INSERT WEAPON SPECIFIED BY (R1.13)

TYPE I OFFENSIVE PHASER TABLE

DIE RANGE	6-9	16-26	51-75							
ROLL 0	1	2	3	4	5	8	15	25	50	75
1	9	8	7	6	5	5	4	3	2	1
2	8	7	6	5	5	4	3	2	1	0
3	7	5	5	4	4	4	3	1	0	0
4	6	4	4	4	4	3	2	0	0	0
5	5	4	4	4	3	3	1	0	0	0
6	4	4	3	3	2	2	0	0	0	0

TYPE II OFFENSIVE/DEFENSIVE PHASER TABLE

DIE RANGE	4-8	9-15	16-30	31-50		
ROLL 0	1	2	3	4	5	6
1	6	5	4	3	2	1
2	6	5	4	4	2	1
3	6	4	4	4	1	0
4	5	4	4	3	1	0
5	5	4	3	3	0	0
6	5	3	3	3	0	0

TYPE III DEFENSE PHASER

DIE RANGE	4-9	15			
ROLL 0	1	2	3	6	15
1	4	4	4	3	1
2	4	4	4	2	1
3	4	4	4	1	0
4	4	4	3	0	0
5	4	3	2	0	0
6	3	3	1	0	0

WARP ENERGY MOVEMENT COST = 1/3 ENERGY POINT PER HEX [5] = HET COST [6] = ERRATIC MANEUVER WARP COST

SPEED	1	2	3	4	5	6	7	8	9	10	11	12	13	14	15	16	17	18	19	20	21	22	23	24	25	26	27	28	29	30
Standard	1	1	2	2	2	3	3	3	4	4	4	4	5	5	5	6	6	6	7	7	7	8	8	9	9	9	10	10	10	
Fract.	1/3	2/3	1	1 1/3	1 2/3	2	2 1/3	2 2/3	3	3 1/3	3 2/3	4	4 1/3	4 2/3	5	5 1/3	5 2/3	6	6 1/3	6 2/3	7	7 1/3	7 2/3	8	8 1/3	8 2/3	9	9 1/3	9 2/3	10



# LARGE FREIGHTER

**ADMINISTRATIVE SHUTTLE**

IDENT	HIT POINTS	NOTES

**CREW UNITS**  
\*2

**SHIP DATA TABLE**

TYPE = F-L  
 POINT VALUE = 61/18  
 BREAKDOWN = 1-6  
 SHIELD COST = 1/2+1/2  
 LIFE SUPPORT = 1/2  
 SIZE CLASS = 4  
 REFERENCE = R1.6

**TYPE II PHASER TABLE**

DIE RANGE	4-9	16-31						
ROLL 0	1	2	3	8	15	30	50	
1	6	5	5	4	3	2	1	1
2	6	5	4	4	2	1	1	0
3	6	4	4	4	1	1	0	0
4	5	4	4	3	1	0	0	0
5	5	4	3	3	0	0	0	0
6	5	3	3	3	0	0	0	0

**TYPE III DEFENSE PHASER**

DIE RANGE	4-9					
ROLL 0	1	2	3	8	15	
1	4	4	4	3	1	1
2	4	4	4	2	1	0
3	4	4	4	1	0	0
4	4	4	3	0	0	0
5	4	3	2	0	0	0
6	3	3	1	0	0	0

**TURN MODE SPEED**

D	1	2-4
NO	2	5-8
HET	3	9-12
BONUS	4	13-17
BD	5	18-24
	6	25+

THIS SHIP CANNOT DISENGAGE BY ACCELERATION.  
 THIS SHIP CAN ACCELERATE BY NO MORE THAN 4 MOVEMENT POINTS PER TURN.  
 THIS SHIP DOES NOT CARRY T-BOMBS.

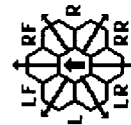

RA = LR + RR

CMTR

SHIELD #1

SHIELD #6

SHIELD #2

SHIELD #5

SHIELD #3

SHIELD #4

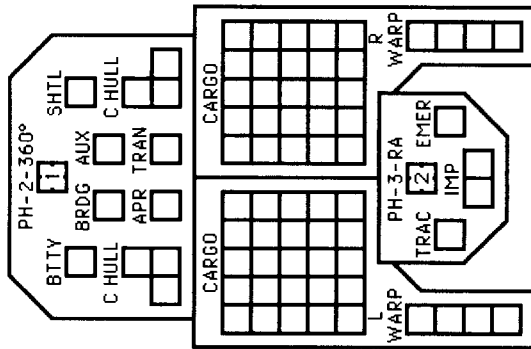

SENSOR 630

SCANNER 029

DAM CONTROL 220

EX DAMAGE

**WARP ENERGY MOVEMENT COST = 1/2 ENERGY POINT PER HEX**    5 = HET COST    6 = ERRATIC MANEUVER WARP COST

SPEED	1	2	3	4	5	6	7	8	9	10	11	12	13	14	15	16	17	18	19	20	21	22	23	24	25	26	27	28	29	30
Standard	1	2	3	3	4	4	4	5	5	6	6	7	7	8	8	9	9	9	10	10	11	11	12	12	13	13	14	14	15	15
Fract.	1/2	1	1 1/2	2	2 1/2	3	3 1/2	4	4 1/2	5	5 1/2	6	6 1/2	7	7 1/2	8	8 1/2	9	9 1/2	10	10 1/2	11	11 1/2	12	12 1/2	13	13 1/2	14	14 1/2	15









# KLINGON SMALL Q SHIP

CNTR

TYPE	= S-Q
POINT VALUE	= 41
BREAKDOWN	= 2-6
SHIELD COST	= 1/2+1/2
LIFE SUPPORT	= 1/2
SIZE CLASS	= 4
REFERENCE	= R1.7
Y175 REFIT	= +1
UIM REFIT	= +5

IDENT	HIT POINTS	NOTES



DIE RANGE	4-9	16-31
ROLL 0	1 2 3 8 15 30 50	
1	6 5 5 4 3 2 1 1	
2	6 5 4 4 2 1 1 0	
3	6 4 4 4 1 1 0 0	
4	5 4 4 3 1 0 0 0	
5	5 4 3 3 0 0 0 0	
6	5 3 3 3 0 0 0 0	

DIE RANGE	4-9	8 15
ROLL 0	1 2 3 8 15	
1	4 4 4 3 1 1	
2	4 4 4 2 1 0	
3	4 4 4 1 0 0	
4	4 4 3 0 0 0	
5	4 3 2 0 0 0	
6	3 3 1 0 0 0	

RANGE	0	1	2	3-4	5-8	9-15	16-22
HIT (STD)	NR	1-5	1-4	1-4	1-4	1-4	1-3
HIT (UIM)	NR	1-5	1-4	1-4	1-4	1-4	1-4
HIT(OVERLOAD)	1-6	1-5	1-4	1-4	1-4	NR	NR
HIT(OL/UIM)	1-6	1-5	1-5	1-5	1-5	NR	NR
DAMAGE, STD	0	5	4	4	3	3	2
DAMAGE, OULD	10	10	8	8	6	6	0

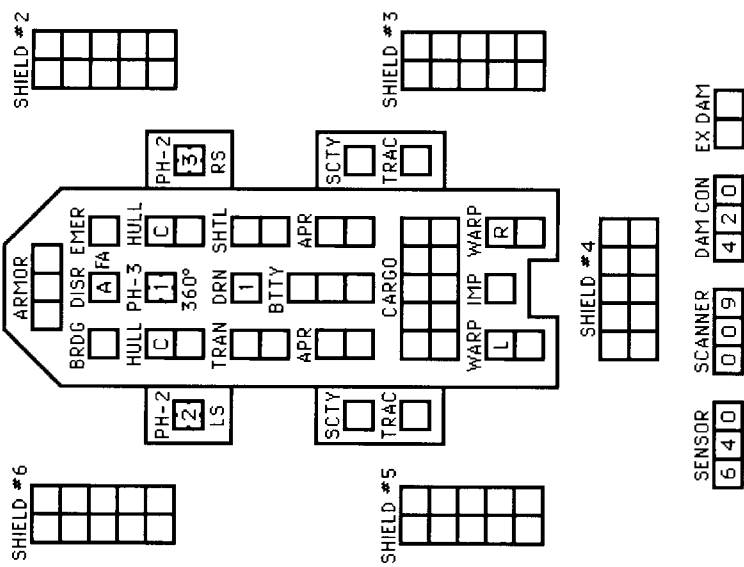

THIS SHIP CAN ACCELERATE BY NO MORE THAN 5 MOVEMENT POINTS OR DOUBLE THE CURRENT SPEED. IT CAN DISENGAGE BY ACCELERATION. SEE SPECIAL COMBAT RULES (R1.7).

**DRONE RACK**  
 1 H H H H A H H B  
 SHIP HAD A TYPE-A DRONE RACK (ONE RELOAD) UNTIL THE Y175 REFIT, WHICH CONVERTED IT TO A TYPE-B DRONE RACK (2 RELOADS).

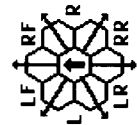

FA = LF + RF  
 LS = LF + L + LR  
 RS = RF + R + RR

SPEED	1	2	3	4	5	6	7	8	9	10	11	12	13	14	15	16	17	18	19	20	21	22	23	24	25	26	27	28	29	30
Standard	1	1	2	2	2	3	3	3	4	4	4	4	5	5	5	6	6	6	6	7	7	7	8	8	8	9	9	9	10	10
Frac.	1/3	2/3	1 1/3	1 2/3	2	2 1/3	2 2/3	3	3 1/3	3 2/3	4	4 1/3	4 2/3	5	5 1/3	5 2/3	6	6 1/3	6 2/3	7	7 1/3	7 2/3	8	8 1/3	8 2/3	9	9 1/3	9 2/3	10	

# GORN LARGE Q SHIP

**CREW UNITS**

* 10
------

**ADMINISTRATIVE SHUTTLES**

IDENT	HIT POINTS	NOTES

TWO BAYS; NO (J1,59) TRANSFERS.

**BOARDING PARTIES**

10	D	D
----	---	---

**SHIP DATA TABLE**

TYPE = L-Q  
 POINT VALUE = 80  
 BREAKDOWN = 2-6  
 SHIELD COST = 1/2+1/2  
 LIFE SUPPORT = 1/2  
 SIZE CLASS = 4  
 REFERENCE = R1.7

**TYPE I OFFENSIVE PHASER TABLE**

DIE RANGE	6-9	9-16	16-26	26-51	51-75
ROLL 0	1	2	3	4	5
1	9	8	7	6	5
2	8	7	6	5	4
3	7	5	4	4	3
4	6	4	4	4	3
5	5	4	4	3	3
6	4	4	3	2	2

**TURNOVER MODE SPEED**

D	NO	HET	BONUS	BD
1	2-4			
2	5-8			
3	9-12			
4	13-17			
5	18-24			
6	25+			

**TYPE III DEFENSE PHASER**

DIE RANGE	4-9	9-15
ROLL 0	1	2
1	4	4
2	4	4
3	4	4
4	4	4
5	4	3
6	3	3

THIS SHIP CAN ACCELERATE BY NO MORE THAN 5 MOVEMENT POINTS OR DOUBLE THE CURRENT SPEED. IT CAN DISENGAGE BY ACCELERATION. SEE SPECIAL COMBAT RULES (R1.7).

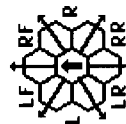

FA = LF + RF  
 LS = LF + L + LR  
 RS = RF + R + RR  
 RA = LR + RR

**PLASMA TORPEDO WARHEAD TABLE**

RANGE	0-5	6-10	11-12	13-14	15
TYPE F	20	15	10	5	1
BOLT	1-4	1-3	1-2		

**PSEUDO PLASMA TORPEDOES**

A	F	B	F
---	---	---	---

CNTR

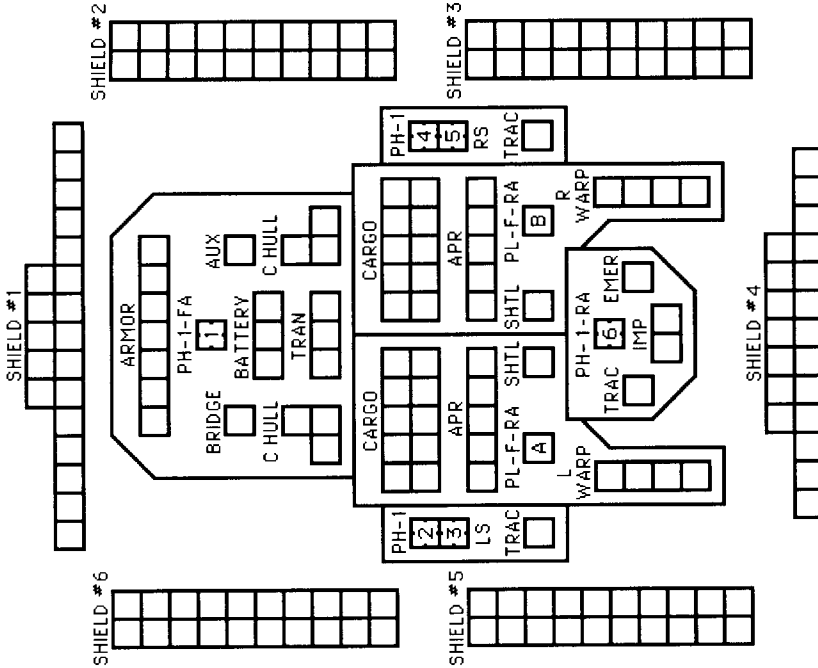

SENSOR [6][6][3][0]    SCANNER [0][0][2][9]    DAM CONTROL [4][2][2][0]    EX DAMAGE [ ] [ ] [ ] [ ]

**WARP ENERGY MOVEMENT COST = 1/2 ENERGY POINT PER HEX**    [5] = HET COST    [6] = ERRATIC MANEUVER WARP COST

SPEED	1	2	3	4	5	6	7	8	9	10	11	12	13	14	15	16	17	18	19	20	21	22	23	24	25	26	27	28	29	30
Standard	1	2	2	3	3	4	4	5	5	6	6	7	7	8	8	9	9	10	10	11	11	12	12	13	13	14	14	15	15	
Fract.	1/2	1	1 1/2	2	2 1/2	3	3 1/2	4	4 1/2	5	5 1/2	6	6 1/2	7	7 1/2	8	8 1/2	9	9 1/2	10	10 1/2	11	11 1/2	12	12 1/2	13	13 1/2	14	14 1/2	15

# GORN SMALL Q SHIP

CREW UNITS

★			6
---	--	--	---

ADMINISTRATIVE SHUTTLES

IDENT	HIT POINTS	NOTES

BOARDING PARTIES

		5
--	--	---

T-BOMBS

		D	D
--	--	---	---

SHIP DATA TABLE

TYPE = S-Q  
 POINT VALUE = 35  
 BREAKDOWN = 2-6  
 SHIELD COST = 1/2+1/2  
 LIFE SUPPORT = 1/2  
 SIZE CLASS = 4  
 REFERENCE = R1.7

TYPE I OFFENSIVE PHASER TABLE

DIE RANGE	6-9	16-26	51-75
ROLL	0 1 2 3 4 5	8 15 25	50 75
1	9 8 7 6 5 5 4 3 2 1	1 1	1
2	8 7 6 5 4 3 2 1 0 0	1 0	0
3	7 5 4 4 3 1 0 0 0 0	0 0	0
4	6 4 4 4 3 2 0 0 0 0	0 0	0
5	5 4 4 3 3 1 0 0 0 0	0 0	0
6	4 4 3 3 2 2 0 0 0 0	0 0	0

TURN MODE SPEED

C	1	2	3	4	5	6
NO						
HET						
BONUS						
BD						
						28+

TYPE III DEFENSE PHASER

DIE RANGE	4-9	15
ROLL	0 1 2 3 8	15
1	4 4 4 3 1 1	1
2	4 4 4 2 1 0	0
3	4 4 4 1 0 0	0
4	4 4 3 0 0 0	0
5	4 3 2 0 0 0	0
6	3 3 1 0 0 0	0

THIS SHIP CAN ACCELERATE BY NO MORE THAN 5 MOVEMENT POINTS OR DOUBLE THE CURRENT SPEED. IT CAN DISENGAGE BY ACCELERATION.

SEE SPECIAL COMBAT RULES (R1.7).

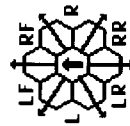

FA = LF + RF  
 LS = LF + L + LR  
 RS = RF + R + RR

PLASMA TORPEDO WARHEAD TABLE

RANGE	0-5	6-10	11-12	13-14	15
TYPE F	20	15	10	5	1
BOLT	1-4	1-3	1-2		

PSEUDO PLASMA TORPEDO

A	F
---	---

WARP ENERGY MOVEMENT COST = 1/3 ENERGY POINT PER HEX

SPEED	1	2	3	4	5	6	7	8	9	10	11	12	13	14	15	16	17	18	19	20	21	22	23	24	25	26	27	28	29	30
Standard	1	1	2	2	2	3	3	3	4	4	4	4	5	5	5	6	6	6	7	7	7	8	8	8	9	9	9	10	10	10
Fract.	1/3	2/3	1	1 1/3	1 2/3	2	2 1/3	2 2/3	3	3 1/3	3 2/3	4	4 1/3	4 2/3	5	5 1/3	5 2/3	6	6 1/3	6 2/3	7	7 1/3	7 2/3	8	8 1/3	8 2/3	9	9 1/3	9 2/3	10

⑤ = HET COST      ⑥ = ERRATIC MANEUVER WARP COST

CNTR

--

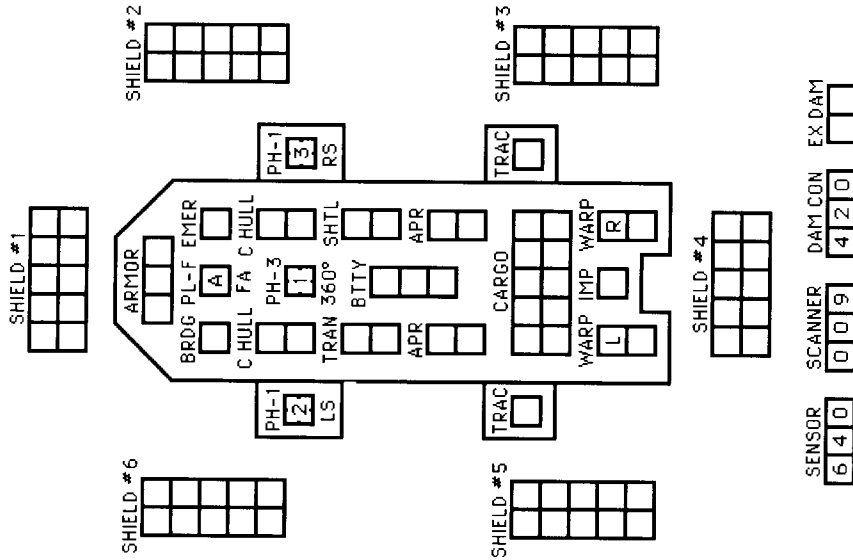











# FEDERATION DESTROYER

CNTR

SHIP DATA TABLE	
TYPE	= DD
POINT VALUE	= 94
BREAKDOWN	= 3-6
SHIELD COST	= 1/2+1/2
LIFE SUPPORT	= 1/2
SIZE CLASS	= 4
REFERENCE	= R2.6
PLUS REFIT	= +6

ADMINISTRATIVE SHUTTLES		
IDENT	HIT POINTS	NOTES

CREW UNITS	
	10
	20

BOARDING PARTIES	
	6

PROBES	
	5

TRANSPORTER BOMBS	
	DD

TYPE I OFFENSIVE PHASER TABLE			
DIE RANGE	6-9	16-26	51-75
ROLL	0 1 2 3 4 5	6 15 25 50	75
1	9 8 7 6 5 4	3 2 1 1	1
2	8 7 6 5 4 3	2 1 1 0	0
3	7 5 4 4 4 3	1 0 0 0	0
4	6 4 4 4 3 2	0 0 0 0	0
5	5 4 4 4 3 1	0 0 0 0	0
6	4 4 3 3 2 0	0 0 0 0	0

TYPE III DEFENSE PHASER	
DIE RANGE	4-9
ROLL	0 1 2 3 8 15
1	4 4 4 3 1 1
2	4 4 4 2 1 0
3	4 4 4 1 0 0
4	4 4 3 0 0 0
5	4 3 2 0 0 0
6	3 3 1 0 0 0

PHOTON TORPEDO TABLE	
RANGE	0-1 2 3-4 5-8 9-12 13-30
HIT, STD	NA 1-5 1-4 1-3 1-2 1
HIT, PROX	NA NA NA NA 1-4 1-3
HIT, OVERLOAD	1-6 1-5 1-4 1-3 NA NA
DAMAGE, STD	NA 8 8 8 8 8
DAMAGE, PROX	NA NA NA NA 4 4
DAMAGE, OVERLOAD	-----VARIES----- NA NA

WARP ENERGY MOVEMENT COST = 1/2 ENERGY POINT PER HEX

SPEED	1	2	3	4	5	6	7	8	9	10	11	12	13	14	15	16	17	18	19	20	21	22	23	24	25	26	27	28	29	30
Standard	1	2	2	3	3	4	4	4	5	5	6	6	7	7	8	8	9	9	10	10	11	11	12	12	13	13	14	14	15	15
Fract.	1/2	1	1 1/2	2	2 1/2	3	3 1/2	4	4 1/2	5	5 1/2	6	6 1/2	7	7 1/2	8	8 1/2	9	9 1/2	10	10 1/2	11	11 1/2	12	12 1/2	13	13 1/2	14	14 1/2	15

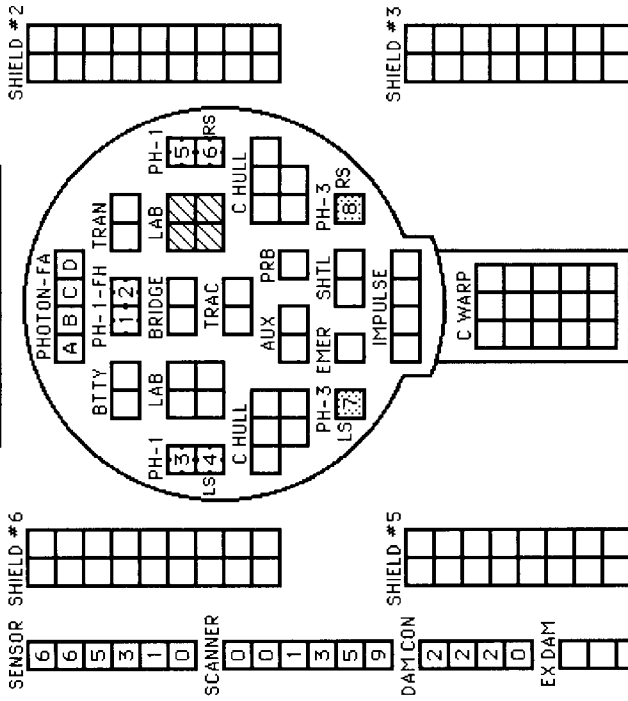

SHADED BOXES ARE THE DD+ REFIT.  
 FOUR OF THE LABS ARE REPLACED WITH AWR BY THE DD+ REFIT.

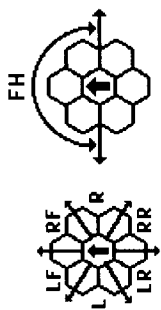

FA = LF + RF  
 LS = LF + L + LR  
 RS = RF + R + RR













# ROMULAN K5R FRIGATE

**CREW UNITS**

						10
						20

**ADMINISTRATIVE SHUTTLES**

IDENT	HIT POINTS	NOTES

THIS SHIP HAS ONE SHUTTLE BAY.

**BOARDING PARTIES**

		5
--	--	---

**TRANSPORTER BOMBS**

		D/D
--	--	-----

**PROBES**

		5
--	--	---

**CLOAK**

		H&R
--	--	-----

**TYPE I OFFENSIVE PHASER TABLE**

DIE RANGE	6-9	16-26	51-75								
ROLL 0	1	2	3	4	5	8	15	25	50	75	
1	9	8	7	6	5	5	4	3	2	1	1
2	8	7	6	5	4	4	3	2	1	1	0
3	7	5	4	4	4	3	1	0	0	0	0
4	6	4	4	4	3	2	0	0	0	0	0
5	5	4	4	4	3	3	1	0	0	0	0
6	4	4	3	3	2	2	0	0	0	0	0

**TYPE II OFFENSIVE/DEFENSIVE PHASER TABLE**

DIE RANGE	6-9	16-30	31-50					
ROLL 0	1	2	3	4-8	9-15	16-30	31-50	
1	6	5	5	4	3	2	1	1
2	6	5	4	4	2	1	1	0
3	6	4	4	4	1	1	0	0
4	5	4	4	3	1	0	0	0
5	5	4	3	3	0	0	0	0
6	5	3	3	3	0	0	0	0

**PSEUDO-PLASMA TORPEDO**

	A	F	B	F
--	---	---	---	---

FA = LF + RF  
RX = L + LR + RR + R

**PLASMA TORPEDO WARHEAD STRENGTH TABLE**

RANGE	0-5	6-10	11-12	13-14	15
TYPE F	20	15	10	5	1
BOLT	1-4	1-3	1-2		

**SHIP DATA TABLE**

TYPE = K5R  
POINT VALUE = 78  
BREAKDOWN = 4-6  
SHIELD COST = 1/2+1/2  
LIFE SUPPORT = 1/2  
SIZE CLASS = 4  
CLOAK COST = 6/2  
REFERENCE = R4.5  
B-REFIT BPV = +6  
BPV INCLUDES CLOAK

**TURN MODE SPEED**

A	1	2-6
HET	2	7-12
BD	3	13-19
	4	20-26
	5	27+

**TYPE III DEFENSE PHASER**

DIE RANGE	4-9	8	15			
ROLL 0	1	2	3	8	15	
1	4	4	4	3	1	1
2	4	4	4	2	1	0
3	4	4	4	1	0	0
4	4	4	3	0	0	0
5	4	3	2	0	0	0
6	3	3	1	0	0	0

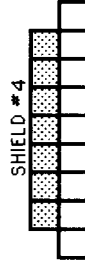
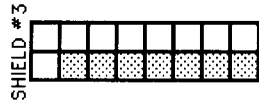
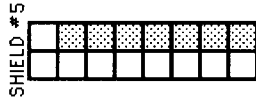
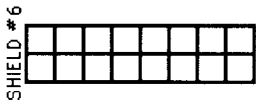
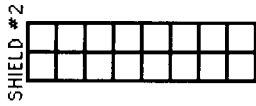
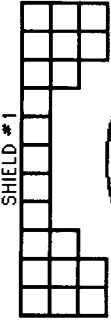
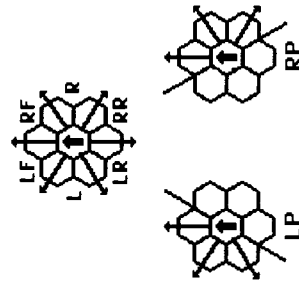

**SENSOR** 6 5 3 0

**SCANNER** 0 1 3 9

**DAMCON** 2 2 2 0

**EX DAM**

SSD SHOWS THE REFITTED SHIP.  
WITHOUT THE REFIT, DELETE THE SHADED BOXES AND CHANGE THE PLASMA-Fs TO AN FA FIRING ARC.  
SPECIAL FIRING ARCS: (D2.33)

**WARP ENERGY MOVEMENT COST = 1/2 ENERGY POINT PER HEX**

SPEED	1	2	3	4	5	6	7	8	9	10	11	12	13	14	15	16	17	18	19	20	21	22	23	24	25	26	27	28	29	30
Standard	1	2	3	3	4	4	5	5	6	6	7	7	8	8	9	9	10	10	11	11	12	12	13	13	14	14	15	15		
Fract.	1/2	1	1 1/2	2	2 1/2	3	3 1/2	4	4 1/2	5	5 1/2	6	6 1/2	7	7 1/2	8	8 1/2	9	9 1/2	10	10 1/2	11	11 1/2	12	12 1/2	13	13 1/2	14	14 1/2	15

⑤ = HET COST      ⑥ = ERRATIC MANEUVER WARP COST

















# KLINGON F5 FRIGATE

CREW UNITS		ADMINISTRATIVE SHUTTLE	
		IDENT	HIT POINTS
		10	20

BOARDING PARTIES		TRANSPORTER BOMBS	

PROBES		ANTI-DRONES	

DRONE RACK	

SHIP HAS TYPE-A DRONE RACK (ONE RELOAD)  
UNTIL THE Y175 REFIT, WHICH CONVERTED  
IT TO TYPE-B DRONE RACK (2 RELOADS).

TYPE I OFFENSIVE PHASER TABLE	
DIE RANGE	6-9-16-26-51-75
ROLL 0	1 2 3 4 5 6 8 15 25 50 75
1	9 8 7 6 5 5 4 3 2 1 1
2	8 7 6 5 5 4 3 2 1 1 0
3	7 5 5 4 4 4 3 1 0 0 0
4	6 4 4 4 4 3 2 0 0 0 0
5	5 4 4 4 3 3 1 0 0 0 0
6	4 4 3 3 2 2 0 0 0 0 0

TYPE II PHASER TABLE	
DIE RANGE	4-9-16-31-50
ROLL 0	1 2 3 8 15 30 50
1	6 5 5 4 3 2 1 1
2	6 5 4 4 2 1 1 0
3	6 4 4 4 1 1 0 0
4	5 4 4 3 1 0 0 0
5	4 3 3 0 0 0 0 0
6	3 3 3 0 0 0 0 0

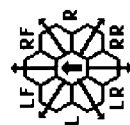

FA = LF + RF  
RX = L + LR + RR + R

DISRUPTOR TABLE	
RANGE	0 1 2 3-4 5-8 9-15
HIT (STD)	NR 1-5 1-5 1-4 1-4 1-4
HIT (OVERLOAD)	1-6 1-5 1-5 1-4 1-4 NR
DAMAGE, STD	0 5 4 4 3 3
DAMAGE, OULD	10 10 8 8 6 0

SHIP DATA TABLE	
TYPE	F5
POINT VALUE	= 71
BREAKDOWN	= 4-6
SHIELD COST	= 1/2+1/2
LIFE SUPPORT	= 1/2
SIZE CLASS	= 4
REFERENCE	= R3.6
B REFIT	= +5
K REFIT	= +2
Y175 REFIT	= +3

TURN MODE SPEED	
A	1 2-6
HET	2 7-12
BD	3 13-19
	4 20-26
	5 27+

TYPE III DEFENSE PHASER	
DIE RANGE	4-9-15
ROLL 0	1 2 3 8 15
1	4 4 4 3 1 1
2	4 4 4 2 1 0
3	4 4 4 1 0 0
4	4 4 3 0 0 0
5	4 3 2 0 0 0
6	3 3 1 0 0 0

ANTI-DRONE TABLE	
RANGE	0 1 2 3 4+
HIT*	- 1-2 1-3 1-4 -

WARP ENERGY MOVEMENT COST = 1/2 ENERGY POINT PER HEX	
SPEED	1 2 3 4 5 6 7 8 9 10 11 12 13 14 15 16 17 18 19 20 21 22 23 24 25 26 27 28 29 30
Standard	1 2 2 3 3 4 4 5 5 6 6 7 7 8 8 9 9 10 10 11 11 12 12 13 13 14 14 15 15
Fract.	1/2 1 1 1/2 2 2 1/2 3 3 1/2 4 4 1/2 5 5 1/2 6 6 1/2 7 7 1/2 8 8 1/2 9 9 1/2 10 10 1/2 11 11 1/2 12 12 1/2 13 13 1/2 14 14 1/2 15

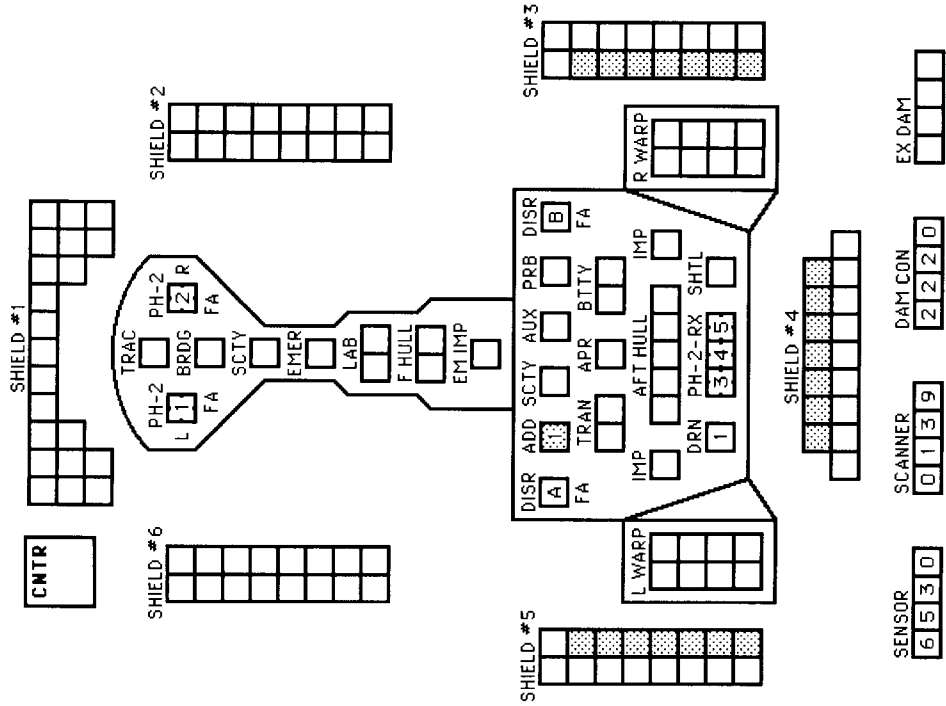

SHADED BOXES ARE THE B-REFIT.  
PHASER-2's MARKED "K" ARE CHANGED TO PHASER-1 ON THE K-REFIT.  
SPECIAL FIRING ARCS: (D2.33)





















# KZINTI ESCORT FRIGATE KZINTI REGIS FRIGATE

SHIP DATA TABLE	
TYPE	= EFF
POINT VALUE	= 65
BREAKDOWN	= 5-6
SHIELD COST	= 1/2+1/2
LIFE SUPPORT	= 1/2
SIZE CLASS	= 4
REFERENCE	= R5.20
C-10 REFIT	= +9
LIMITED AEGIS	

CREW UNITS		ADMINISTRATIVE SHUTTLES	
IDENT	HIT POINTS	IDENT	NOTES
10	20		

BOARDING PARTIES		TRANSPORTER BOMBS	
DECK	CREWS		
2		D	D

DRONE RACKS	
1	2
A C	A C

EFF HAD TYPE-A DRONE RACKS (ONE RELOAD)  
AFF HAD TYPE-C DRONE RACKS (TWO RELOADS)

AS A CARRIER ESCORT, THIS SHIP HAS TWO DECK CREWS AND A READY RACK TO SERVICE THE FIGHTERS FROM THE CARRIER. IT HAS NO FIGHTERS OF ITS OWN.

TYPE I OFFENSIVE PHASER TABLE	
DIE RANGE	6- 9- 16- 26- 51- ROLL 0 1 2 3 4 5 8 15 25 50 75
1	9 8 7 6 5 5 4 3 2 1 1 1
2	8 7 6 5 5 4 3 2 1 1 0 0
3	7 5 5 4 4 4 3 1 0 0 0 0
4	6 4 4 4 4 4 3 2 0 0 0 0
5	5 4 4 4 4 3 3 1 0 0 0 0
6	4 4 3 3 2 2 2 0 0 0 0 0

TYPE III DEFENSE PHASER	
DIE RANGE	4- 9- ROLL 0 1 2 3 8 15
1	4 4 4 3 1 1
2	4 4 4 2 1 0
3	4 4 4 1 0 0
4	4 4 3 0 0 0
5	4 3 2 0 0 0
6	3 3 1 0 0 0

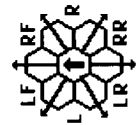

LS = LF + L + LR  
RS = RF + R + RR

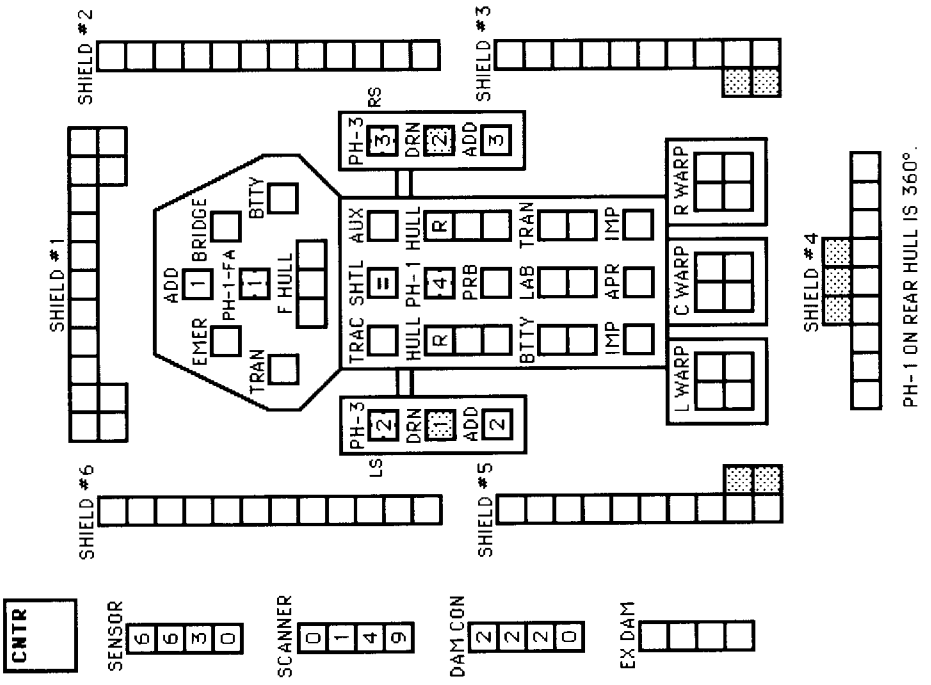

PH-1 ON REAR HULL IS 360°  
SHADED BOXES ARE THE C-10 REFIT.

TURN MODE	SPEED
A 1	2-6
HET 2	7-12
3	13-19
4	20-26
5	27+

ANTI-DRONE TABLE	
RANGE	0 1 2 3 4+
HIT*	- 1-2 1-3 1-4 -

WARP ENERGY MOVEMENT COST = 1/3 ENERGY POINT PER HEX		5 = HET COST	6 = ERRATIC MANEUVER WARP COST
SPEED	1 2 3 4	5	6
Standard	1 1 2 2 2 3 3 3 4 4 4 5 5 5 6 6 6 7 7 7 8 8 8 9 9 9 10 10 10		
Fract.	1/3 2/3 1 1 1/3 1 2/3 2 2 1/3 2 2 1/3 3 3 1/3 3 2 2/3 3 3 1/3 3 2 2/3 4 4 1/3 4 2 2/3 5 5 1/3 5 2 2/3 6 6 1/3 6 2 2/3 7 7 1/3 7 2 2/3 8 8 1/3 8 2 2/3 9 9 1/3 9 2 2/3 10		





# GORN DESTROYER

### ADMINISTRATIVE SHUTTLES

IDENT	HIT POINTS	NOTES
	10	
	20	

PROBES

		5
--	--	---

BOARDING PARTIES

		6
--	--	---

TRANSPORTER BOMBS

		D	D
--	--	---	---

SHIP DATA TABLE

TYPE	=	DD
POINT VALUE	=	68
BREAKDOWN	=	4-6
SHIELD COST	=	1/2+1/2
LIFE SUPPORT	=	1/2
SIZE CLASS	=	4
REFERENCE	=	R6.4
PLUS REFIT	=	+6

TYPE I OFFENSIVE PHASER TABLE

DIE ROLL	0	1	2	3	4	5	6	7	8	9	15	16	25	26	51	75
1	9	8	7	6	5	5	4	3	2	1	1	1	1	1	1	1
2	8	7	6	5	4	4	3	2	1	0	0	0	0	0	0	0
3	7	5	4	4	4	3	1	0	0	0	0	0	0	0	0	0
4	6	4	4	4	4	3	2	0	0	0	0	0	0	0	0	0
5	5	4	4	4	3	3	1	0	0	0	0	0	0	0	0	0
6	4	4	3	3	2	2	0	0	0	0	0	0	0	0	0	0

TYPE III DEFENSE PHASER

DIE ROLL	0	1	2	3	4	8	9	15
1	4	4	4	3	1	1	1	1
2	4	4	4	2	1	0	0	0
3	4	4	4	1	0	0	0	0
4	4	4	3	0	0	0	0	0
5	4	3	2	0	0	0	0	0
6	3	3	1	0	0	0	0	0

PSEUDO-PLASMA TORPEDO

	A	G
--	---	---

PLASMA TORPEDO WARHEAD STRENGTH TABLE

RANGE	0-5	6-10	11-12	13-14	15	16-18	19	20
TYPE G	20	20	15	15	10	5	1	0
TYPE F	20	15	10	5	1	0	0	0
BOLT	1-4	1-3			1-2			

WARP ENERGY MOVEMENT COST = 1/2 ENERGY POINT PER HEX

SPEED	1	2	3	4	5	6	7	8	9	10	11	12	13	14	15	16	17	18	19	20	21	22	23	24	25	26	27	28	29	30
Standard	1	2	3	3	4	4	5	5	6	6	7	7	8	8	9	9	10	10	11	11	12	12	13	13	14	14	15	15	15	15
Fract.	1/2	1	1 1/2	2	2 1/2	3	3 1/2	4	4 1/2	5	5 1/2	6	6 1/2	7	7 1/2	8	8 1/2	9	9 1/2	10	10 1/2	11	11 1/2	12	12 1/2	13	13 1/2	14	14 1/2	15

CNTR

--	--

SENSOR

6	6	4	1	0
---	---	---	---	---

SCANNER

0	0	1	5	9
---	---	---	---	---

DAMCON

2	2	2	0
---	---	---	---

EX.DAM

--	--	--	--

TURN MODE SPEED

C	1	2-4
	2	5-9
	3	10-14
	4	15-20
	5	21-27
	6	28+

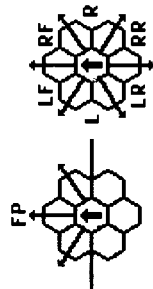

ON THE DD+ REFIT, CHANGE THE PL-G TORPEDO FROM FA TO FP AND ADD THE SHADED BOXES.

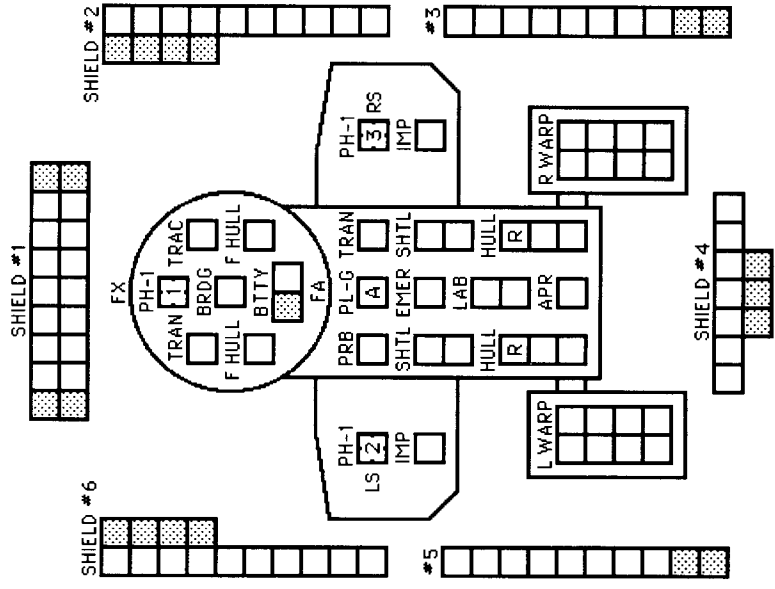



# THOLIAN PATROL CORVETTE

CREW UNITS

10							
----	--	--	--	--	--	--	--

ADMINISTRATIVE SHUTTLES

IDENT	HIT POINTS	NOTES

BOARDING PARTIES

6			
---	--	--	--

TRANSPORTER BOMBS

D	D
---	---

PROBES

5			
---	--	--	--

SHIP DATA TABLE

TYPE	=	PC
POINT VALUE	=	59
BREAKDOWN	=	5-6
SHIELD COST	=	1/2+1/2
LIFE SUPPORT	=	1/2
SIZE CLASS	=	4
REFERENCE	=	R7.2
SNARE REFIT	=	+6

TYPE I OFFENSIVE PHASER TABLE

DIE RANGE	6-	9-	16-	26-	51-
ROLL 0	1	2	3	4	5
1	9	8	7	6	5
2	8	7	6	5	4
3	7	5	4	4	3
4	6	4	4	4	3
5	5	4	4	3	3
6	4	4	3	2	2

TURN MODE SPEED

A	1	2-6
HET	2	7-12
BD	3	13-19
	4	20-26
	5	27+

NIMBLE SHIP

TYPE III DEFENSE PHASER

DIE RANGE	4-	9-
ROLL 0	1	2
1	4	4
2	4	4
3	4	4
4	4	4
5	4	3
6	3	3

CNTR

--	--	--	--

SENSOR

6	5	3	1	0
---	---	---	---	---

SCANNER

0	1	3	5	9
---	---	---	---	---

DAMICON

2	2	2	0
---	---	---	---

EX-DAM

--	--	--	--

SHIELD #1

--	--	--	--	--	--

SHIELD #6

--	--	--	--	--	--

SHIELD #2

--	--	--	--	--	--

SHIELD #3

--	--	--	--	--	--

SHIELD #4

--	--	--	--	--	--

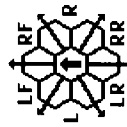
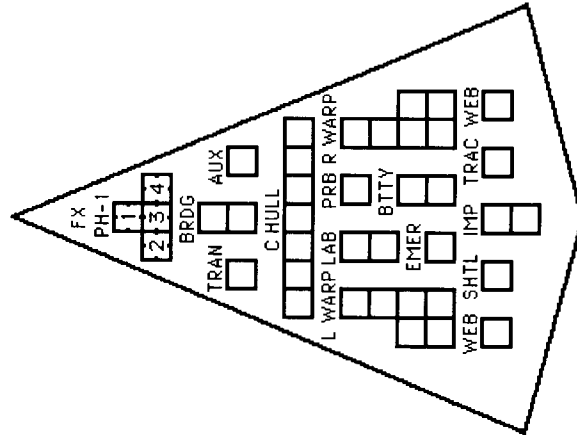

FX = L + LF + RF + R

THIS SHIP CAN LAND ON PLANETS USING THE GRAVITY LANDING SYSTEM (P2.432). WEB GENERATOR IS HIT ON "FLAG BRIDGE" HITS. SNARE REFIT ALLOWS BOTH WEB GENERATORS TO OPERATE AS SNARES.

WARP ENERGY MOVEMENT COST = 1/3 ENERGY POINT PER HEX

SPEED	1	2	3	4	5	6	7	8	9	10	11	12	13	14	15	16	17	18	19	20	21	22	23	24	25	26	27	28	29	30	
Standard	1	1	2	2	2	3	3	3	4	4	4	4	5	5	5	6	6	6	7	7	7	8	8	8	9	9	9	10	10	10	10
Fract.	1/3	2/3	1	1 1/3	1 2/3	2	2 1/3	2 2/3	3	3 1/3	3 2/3	4	4 1/3	4 2/3	5	5 1/3	5 2/3	6	6 1/3	6 2/3	7	7 1/3	7 2/3	8	8 1/3	8 2/3	9	9 1/3	9 2/3	10	

# THOLIAN IMPROVED PATROL CORVETTE

**CREW UNITS**

10									
----	--	--	--	--	--	--	--	--	--

**ADMINISTRATIVE SHUTTLES**

IDENT	HIT POINTS	NOTES

**BOARDING PARTIES**

6			
---	--	--	--

**TRANSPORTER BOMBS**

D	D
---	---

**PROBES**

5			
---	--	--	--

**TYPE I OFFENSIVE PHASER TABLE**

DIE RANGE	6-9	16-26	51-75
ROLL 0	1 2 3 4 5 6 7 8 9 15 25 50 75		
1	9 8 7 6 5 5 4 3 2 1 1		
2	8 7 6 5 4 3 2 1 1 0 0		
3	7 5 4 4 3 1 0 0 0 0 0		
4	6 4 4 4 3 2 0 0 0 0 0		
5	5 4 4 4 3 3 1 0 0 0 0		
6	4 4 3 3 2 2 0 0 0 0 0		

**TYPE III DEFENSE PHASER**

DIE RANGE	4-9
ROLL 0	1 2 3 8 15
1	4 4 4 3 1 1
2	4 4 4 2 1 0
3	4 4 4 1 0 0
4	4 4 3 0 0 0
5	4 3 2 0 0 0
6	3 3 1 0 0 0

THIS SHIP CAN LAND ON PLANETS USING THE GRAVITY LANDING SYSTEM (P2.432).

**SHIP DATA TABLE**

TYPE = PC+  
 POINT VALUE = 65  
 BREAKDOWN = 5-6  
 SHIELD COST = 1/2+1/2  
 LIFE SUPPORT = 1/2  
 SIZE CLASS = 4  
 REFERENCE = R7.3

**TURN MODE SPEED**

A	1	2-6
HET	2	7-12
	3	13-19
BD	4	20-26
	5	27+

**NIMBLE SHIP**

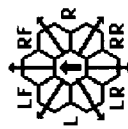

LS = LF + L + LR  
 RS = RF + R + RR  
 FX = L + LF + RF + R

**CNTR**

--	--	--	--

**SENSOR**

6	5	3	1	0
---	---	---	---	---

**SCANNER**

0	1	3	5	9
---	---	---	---	---

**DAM CON**

2	2	2	0
---	---	---	---

**EX DAM**

--	--	--	--

**SHIELD #1**

**SHIELD #2**

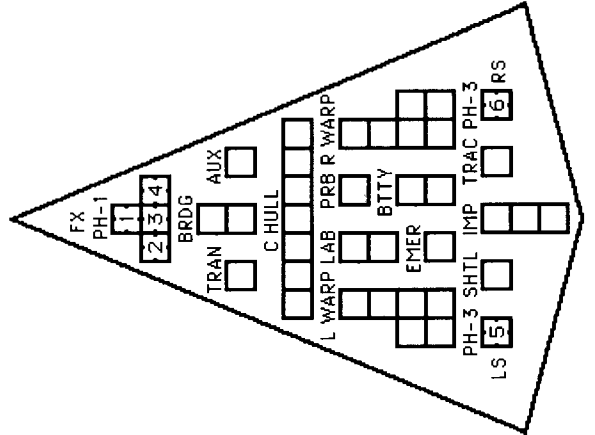
**SHIELD #3**

**SHIELD #6**

**SHIELD #5**

**SHIELD #4**

**WARP ENERGY MOVEMENT COST = 1/3 ENERGY POINT PER HEX**      **5 = HET COST**      **3 = ERRATIC MANEUVER WARP COST**

SPEED	1	2	3	4	5	6	7	8	9	10	11	12	13	14	15	16	17	18	19	20	21	22	23	24	25	26	27	28	29	30
Standard	1	1	2	2	2	3	3	3	4	4	4	4	5	5	5	6	6	6	7	7	7	8	8	9	9	9	9	10	10	10
Fract.	1/3	2/3	1	1 1/3	1 2/3	2	2 1/3	2 2/3	3	3 1/3	3 2/3	4	4 1/3	4 2/3	5	5 1/3	5 2/3	6	6 1/3	6 2/3	7	7 1/3	7 2/3	8	8 1/3	8 2/3	9	9 1/3	9 2/3	10

# ORION RAIDER CRUISER

CREW UNITS		ADMINISTRATIVE SHUTTLES	
IDENT	HIT POINTS	NOTES	
	10		
	20		

BOARDING PARTIES	
	10

TRANSPORTER BOMBS	
	D D D D

CLOAK  
 H&R  
 IF INSTALLED

SHIP DATA TABLE	
TYPE	= CR
POINT VALUE	= 92
BREAKDOWN	= 6
SHIELD COST	= 1+1
LIFE SUPPORT	= 1
CLOAK COST	= 10/2
SIZE CLASS	= 3
REFERENCE	= R8.2
PLUS REFIT	= +8
CLOAK	= +18
DAKDISC	= +5
STEALTH	+2ECM

TURN MODE	SPEED
A	1 2-6
HET	2 7-12
BD	3 13-19
	4 20-26
	5 27+

NIMBLE SHIP

TYPE I OFFENSIVE PHASER TABLE	
DIE RANGE	6- 9- 16- 26- 51- ROLL 0 1 2 3 4 5 8 15 25 50 75
1	9 8 7 6 5 5 4 3 2 1 1 0 0 0
2	8 7 6 5 4 4 3 2 1 1 0 0 0
3	7 5 4 4 4 3 2 1 0 0 0 0 0
4	6 4 4 4 3 2 0 0 0 0 0 0 0
5	5 4 4 4 3 3 1 0 0 0 0 0 0
6	4 4 3 3 2 2 0 0 0 0 0 0 0

TYPE III DEFENSE PHASER	
DIE RANGE	4- 9- ROLL 0 1 2 3 8 15
1	4 4 4 3 1 1
2	4 4 4 2 1 0
3	4 4 4 1 0 0
4	4 4 3 0 0 0
5	4 3 2 0 0 0
6	3 3 1 0 0 0

LF RF  
 LR RR  
 FA = LF + RF  
 LS = LF + L + LR  
 RS = RF + R + RR  
 RA = LR + RR

INSERT OPTIONAL WEAPONS  
 NO HELLBORES IN WING MOUNTS.  
 SEE ANNEXES \*8A AND \*8B.

INSERT OPTIONAL WEAPONS  
 NO HELLBORES IN WING MOUNTS.  
 SEE ANNEXES \*8A AND \*8B.

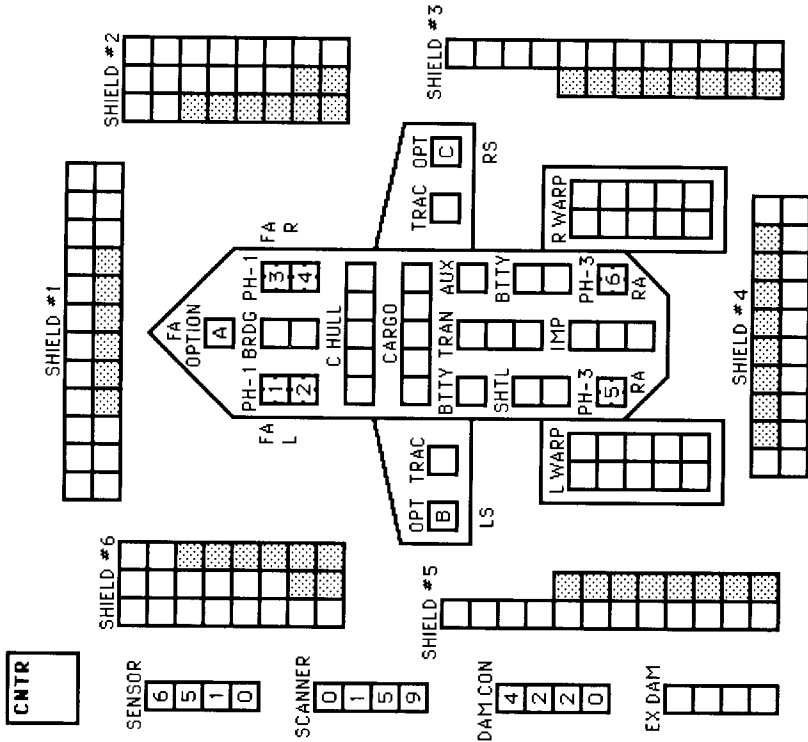

WARP ENERGY MOVEMENT COST = 2/3 ENERGY POINT PER HEX		5 = HET COST
SPEED	1 2 3 4 5 6 7 8 9 10 11 12 13 14 15 16 17 18 19 20 21 22 23 24 25 26 27 28 29 30	
Standard	1 2 3 4 4 5 6 6 7 8 8 9 10 10 11 12 12 13 14 14 15 16 16 17 18 18 19 20 20	
Fract.	2/3 1 1/3 2 2 2/3 3 1/3 4 4 2/3 5 1/3 6 6 2/3 7 1/3 8 8 2/3 9 1/3 10 10 2/3 11 1/3 12 12 2/3 13 1/3 14 14 2/3 15 1/3 16 16 2/3 17 1/3 18 18 2/3 19 1/3 20	



# CARGO PODS

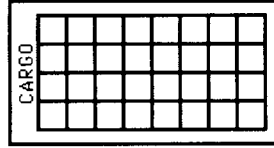
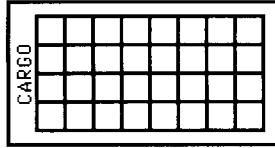

# STARLINER POD

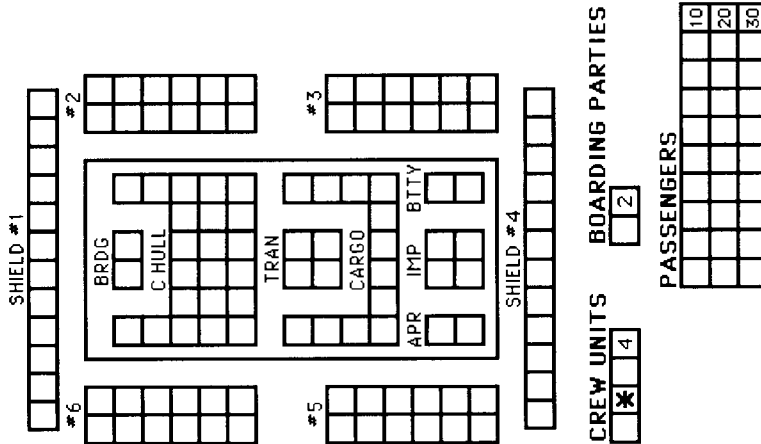

# BATTLE POD

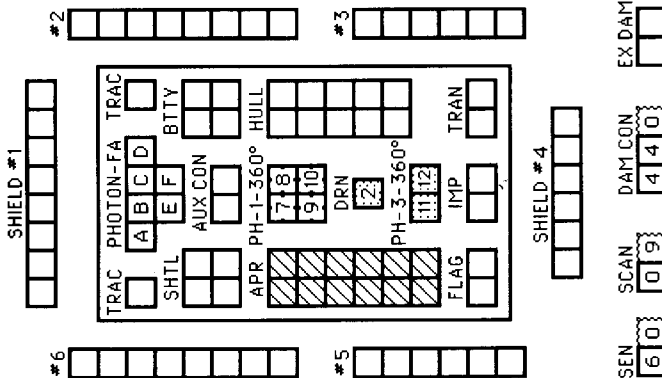

**CREW UNITS**

*										10
										20

**BOARDING PARTIES**

										8
--	--	--	--	--	--	--	--	--	--	---

**DRONE RACK**  
 1 2 3 4 5 6  
 RACK HAD TWO RELOADS PRIOR TO Y175, THREE THEREAFTER. ONE RELOAD IS ENTIRELY ADDS.

**ADMINISTRATIVE SHUTTLES**

IDENT	HIT POINTS	NOTES

**TRANSPORTER BOMBS**

		D	D
--	--	---	---

- SHADED BOXES ARE THE PLUS REFIT.
- APR ON THE POD BECOMES AWR AS PART OF THE PLUS REFIT.

**TYPE I OFFENSIVE PHASER TABLE**

DIE RANGE	6-9	16-26	51-75
ROLL 0	1	2	3
1	9	8	7
2	8	7	6
3	7	5	4
4	6	4	4
5	5	4	4
6	4	4	3

**PHOTON TORPEDO TABLE**

RANGE	0-1	2	3-4	5-8	9-12	13-30
HIT, STD	NA	1-5	1-4	1-3	1-2	1
HIT, PROX	NA	NA	NA	NA	1-4	1-3
HIT, OVERLORD	1-6	1-5	1-4	1-3	NA	NA
DAMAGE, STD	NA	8	8	8	8	8
DAMAGE, PROX	NA	NA	NA	NA	4	4
DMGE, OVERLORD	-----	VARIES	-----	-----	-----	-----

**ANTI-DRONE TABLE**

RANGE	0	1	2	3	4+
HIT*	-	1-2	1-3	1-4	-

**TYPE III DEFENSE PHASER**

DIE RANGE	4-9	15
ROLL 0	1	2
1	4	4
2	4	4
3	4	4
4	4	4
5	4	3
6	3	3

**DATA TABLE**

TYPE	P-BP	P-SL	P-CP
POINT VALUE	88/45	48/20	21/15
BREAKDOWN	1/2+1/2	1/2+1/2	-
SHIELD COST	1/2	1/2	-
LIFE SUPPORT	4	4	4
SIZE CLASS	R2.10	R2.9	R2.11
REFERENCE	+20	NA	NA
PLUS REFIT			

# STAR FLEET BATTLES — BASIC SET CHARTS

## (D4.21) DAMAGE ALLOCATION CHART

Copyright © 2000 Amarillo Design Bureau, Inc.

DIE ROLL	A	B	C	D	E	F	G	H	I	J	K	L	M
2	<u>Bridge</u>	<u>Flag Bridge</u>	<u>Sensor</u>	<u>Damage Control</u>	<u>A Hull</u>	Left W En	Trans	Tractor	Shuttle	Lab	F Hull	Right W En	Excess Damage
3	<u>Drone</u>	<u>Phaser</u>	Impulse	Left W En	Right W En	A Hull	Shuttle	<u>Damage Control</u>	Center W En	Lab	Battery	Phaser	Excess Damage
4	<u>Phaser</u>	<u>Trans</u>	Right W En	Impulse	F Hull	A Hull	Left W En	APR	Lab	Trans	Probe	Center W En	Excess Damage
5	<u>Right W En</u>	A Hull	Cargo	Battery	Shuttle	<u>Torp</u>	Left W En	Impulse	Right W En	Tractor	Probe	Any Weapon	Excess Damage
6	F Hull	Impulse	Lab	Left W En	<u>Sensor</u>	Tractor	Shuttle	Right W En	Phaser	Trans	Battery	Any Weapon	Excess Damage
7	Cargo	F Hull	Battery	Center W En	Shuttle	APR	Lab	Phaser	Any W En	Probe	A Hull	Any Weapon	Excess Damage
8	A Hull	APR	Shuttle	Right W En	<u>Scanner</u>	Tractor	Lab	Left W En	Phaser	Trans	Battery	Any Weapon	Excess Damage
9	<u>Left W En</u>	F Hull	Cargo	Battery	Lab	<u>Drone</u>	Right W En	Impulse	Left W En	Tractor	Probe	Any Weapon	Excess Damage
10	<u>Phaser</u>	<u>Tractor</u>	Left W En	Impulse	A Hull	F Hull	Right W En	APR	Lab	Trans	Probe	Center W En	Excess Damage
11	<u>Torp</u>	<u>Phaser</u>	Impulse	Right W En	Left W En	F Hull	Tractor	<u>Damage Control</u>	Center W En	Lab	Battery	Phaser	Excess Damage
12	<u>Aux Control</u>	<u>Emer Bridge</u>	<u>Scanner</u>	<u>Probe</u>	<u>F Hull</u>	Right W En	Trans	Shuttle	Tractor	Lab	A Hull	Left W En	Excess Damage



**D2.12 FIRING ARC DESIGNATIONS**

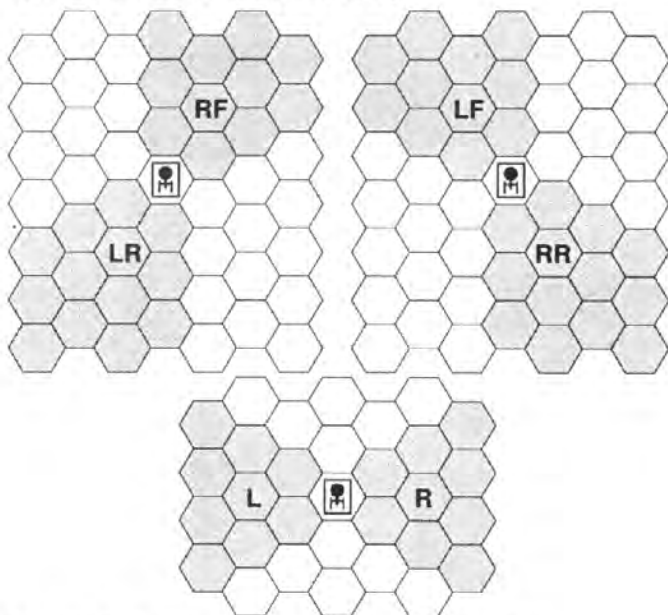

- |                         |                   |
|-------------------------|-------------------|
| FA = FRONT ARC          | = RF + LF         |
| FX = FRONT ARC EXPANDED | = L + LF + RF + R |
| RA = REAR ARC           | = LR + RR         |
| RX = REAR ARC EXPANDED  | = L + LR + RR + R |
| RS = RIGHT SIDE         | = RF + R + RR     |
| LS = LEFT SIDE          | = LF + L + LR     |
| FH = FRONT HEMISPHERE   | = See (D2.31)     |
| RH = REAR HEMISPHERE    | = See (D2.31)     |
| LP = LEFT PLASMA        | = See (D2.34)     |
| RP = RIGHT PLASMA       | = See (D2.34)     |
| FP = FRONT PLASMA       | = See (D2.34)     |
| AP = AFT PLASMA         | = See (D2.36)     |
| LPR = LEFT PLASMA REAR  | = See (D2.36)     |
| RPR = RIGHT PLASMA REAR | = See (D2.36)     |

**D2.31 HEMISPHERIC FIRING ARCS**

The FH (front half or front hemisphere) firing arc:

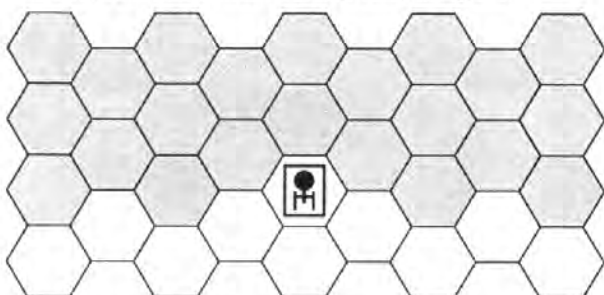

The RH (rear half or rear hemisphere) firing arc:

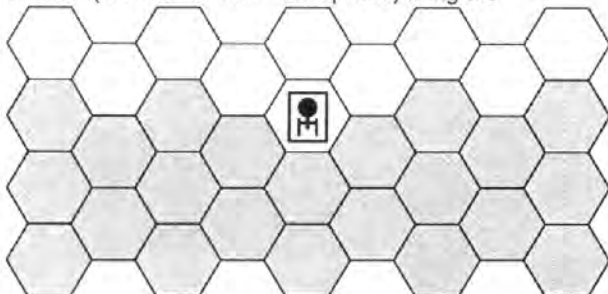

**(D2.32) KLINGON WING PHASERS:** This illustration is for the right wing phasers. The hexes marked "+" are added to the firing arc; The hexes marked "-" are deleted from the firing arc.

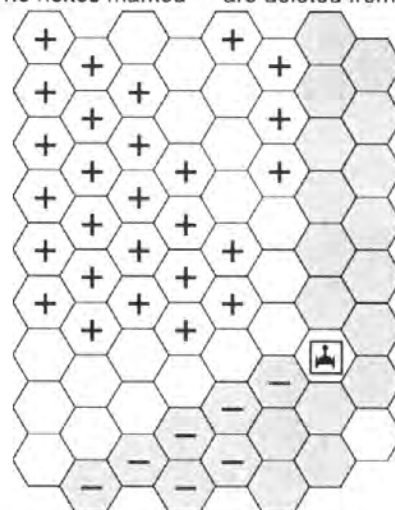

NOTE: Right Wing Phasers shown.

**(D2.33) KLINGON FORWARD PHASERS:** This illustration is for the forward phasers of many Klingon ships. If the forward phasers are divided into two group, the right group gets the pluses on right side, and the left group gets those on the left.

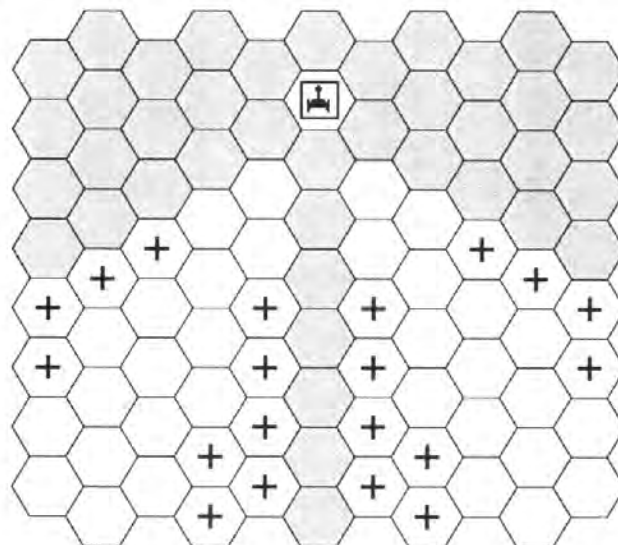

The rear firing area for the right wing phasers on the B10 or C8/9 and for the right side boom phasers on the F5/E4:



## D — COMBAT

## FIRING ARC READY REFERENCE CARD

**(D2.34) PLASMA TORPEDO SWIVEL MOUNTS:** Certain ships are equipped with swivel mounts for their plasma torpedoes. These ships are able to track targets in a 180° firing arc and to fire their weapons in any of three specified directions. The illustrations below show these arcs, which are designated LP, FP, and RP (for left, forward, and right plasma arcs).

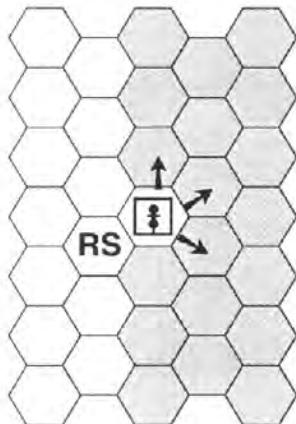
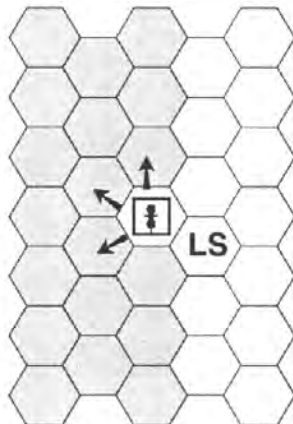
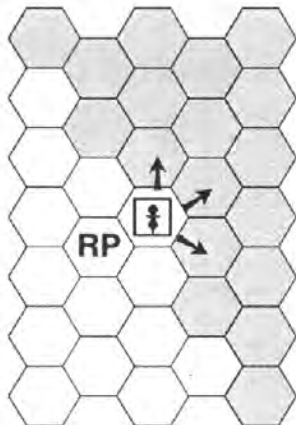
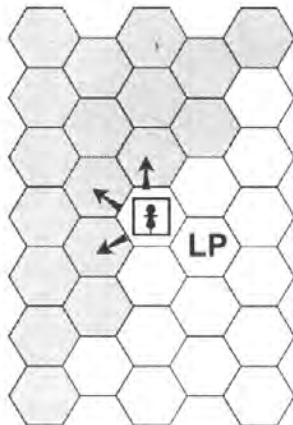
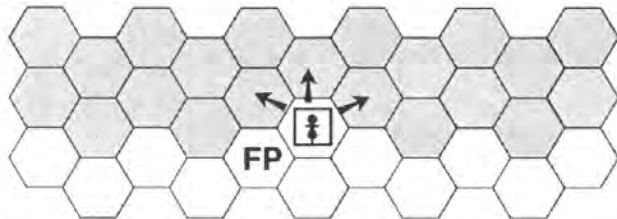

Arrows denote launch direction.  
Shading denotes tracking arc.

Some ships have small type-F plasma torpedoes in LS or RS mounts, rather than LP or RP. These can track targets in the LS or RS arcs and can be fired in directions 1, 5 or 6 (LS) and 1, 2 or 3 (RS). This is primarily an anti-fighter defense weapon, set in this arc to avoid a blind spot at the tail.

Plasma racks for type-D torpedoes using LS/RS arcs are defined in (FP10.12).

**(D2.35) ISC REAR-FIRING PLASMA TORPEDO ARCS:** Most of the ships used by the Interstellar Concordium (R13.0) are equipped with rear-firing type-F plasma torpedoes.

The ISC is presented in Module C2. If you do not have module C2, this data can be ignored.

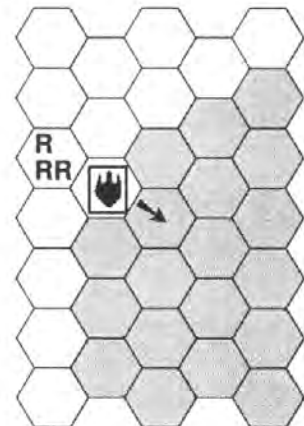
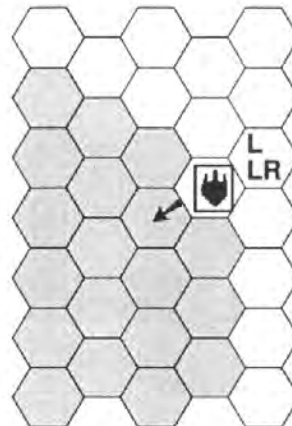

**(D2.36) GORN BATTLE POD REVERSE SWIVEL PLASMA TORPEDO FIRING ARCS:** These arcs are used by the Gorn Heavy Battle Pod and Light Battle Pod carried by their tug and light tactical transport. The position of the pod on the ship requires these unusual and difficult to use arcs.

These pods are in Advanced Missions and Module R4; this data can be ignored by Basic Set users.

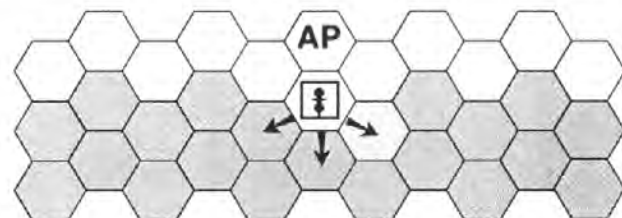
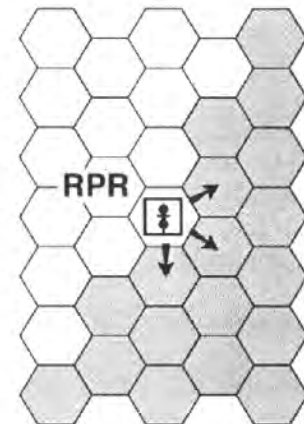
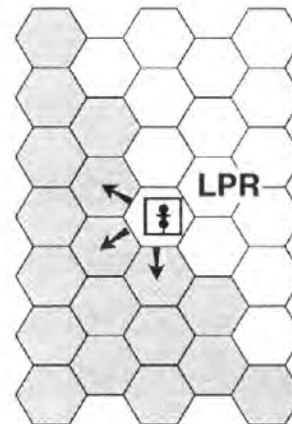

Arrows denote launch direction.  
Shading denotes tracking arc.

SPEED →	32	31	30	29	28	27	26	25	24	23	22	21	20	19	18	17	16	15	14	13	12	11	10	9	8	7	6	5	4	3	2
1	1	—	—	—	—	—	—	—	—	—	—	—	—	—	—	—	—	—	—	—	—	—	—	—	—	—	—	—	—	—	
2	2	1	1	1	1	1	1	1	1	1	1	1	1	1	1	1	1	—	—	—	—	—	—	—	—	—	—	—	—	—	
3	3	2	2	2	2	2	2	2	2	2	2	—	—	—	—	—	1	1	1	1	1	—	—	—	—	—	—	—	—	—	
4	4	3	3	3	3	3	3	3	3	—	—	2	2	2	2	2	—	—	—	—	—	1	1	1	—	—	—	—	—	—	
5	5	4	4	4	4	4	4	—	—	3	3	3	3	—	—	—	2	2	2	—	—	—	—	—	1	—	—	—	—	—	
6	6	5	5	5	5	5	—	4	4	4	4	—	—	3	3	3	3	—	—	—	2	2	—	—	—	1	—	—	—	—	
7	7	6	6	6	6	—	5	5	5	5	—	4	4	4	—	—	3	3	—	—	—	2	—	—	—	—	1	—	—	—	
8	8	7	7	7	7	6	6	6	6	—	5	5	5	—	4	4	4	—	—	3	3	—	—	2	2	—	—	—	1	—	
9	9	8	8	8	—	7	7	7	—	6	6	—	—	5	5	—	—	4	—	—	—	3	—	—	—	—	—	—	—	—	
10	10	9	9	9	8	8	8	—	7	7	—	6	6	—	—	5	5	—	4	4	—	—	3	—	—	2	—	—	—	—	
11	11	10	10	—	9	9	—	8	8	—	7	7	—	6	6	—	—	5	—	—	4	—	—	3	—	—	2	—	—	1	—
12	12	11	11	10	10	10	9	9	9	8	8	—	7	7	—	6	6	—	5	—	—	4	—	—	3	—	—	—	—	—	
13	13	12	12	11	11	—	10	10	—	9	—	8	8	—	7	—	—	6	—	5	—	—	4	—	—	—	—	2	—	—	—
14	14	13	13	12	12	11	11	—	10	10	9	9	—	8	—	7	7	—	6	—	5	—	—	—	—	3	—	—	—	—	
15	15	14	14	13	13	12	12	11	11	—	10	—	9	—	8	—	—	7	—	6	—	5	—	4	—	—	—	—	—	—	—
16	16	15	15	14	14	13	13	12	12	11	11	10	10	9	9	8	8	—	7	—	6	—	5	—	4	—	3	—	2	—	1
17	17	16	—	15	—	14	—	13	—	12	—	11	—	10	—	9	—	—	—	—	—	—	—	—	—	—	—	—	—	—	—
18	18	17	16	16	15	15	14	14	13	—	12	—	11	—	10	—	9	8	—	7	—	6	—	5	—	—	—	—	—	—	—
19	19	18	17	17	16	16	15	—	14	13	13	12	—	11	—	10	—	—	8	—	7	—	—	—	—	4	—	—	—	—	—
20	20	19	18	18	17	—	16	15	15	14	—	13	12	—	11	—	10	9	—	8	—	—	6	—	5	—	—	3	—	—	—
21	21	20	19	19	18	17	17	16	—	15	14	—	13	12	—	11	—	—	9	—	—	7	—	—	—	—	—	—	—	—	—
22	22	21	20	—	19	18	—	17	16	—	15	14	—	13	12	—	11	10	—	—	8	—	—	6	—	—	4	—	—	2	—
23	23	22	21	20	20	19	18	—	17	16	—	15	14	—	12	—	—	10	9	—	—	7	—	—	5	—	—	—	—	—	
24	24	23	22	21	21	20	19	18	18	17	16	—	15	14	13	—	12	11	—	—	9	8	—	—	6	—	—	—	3	—	—
25	25	24	23	22	—	21	20	19	—	—	17	16	—	—	14	13	—	—	—	10	—	—	—	7	—	—	—	—	—	—	—
26	26	25	24	23	22	—	21	20	19	18	—	17	16	15	—	—	13	12	11	—	—	—	8	—	—	—	4	—	—	—	—
27	27	26	25	24	23	22	—	21	20	19	18	—	—	16	15	14	—	—	—	—	10	9	—	—	—	—	5	—	—	—	—
28	28	27	26	25	24	23	22	—	21	20	19	18	17	—	—	—	14	13	12	11	—	—	—	—	7	6	—	—	—	—	
29	29	28	27	26	25	24	23	22	—	—	19	18	17	16	15	—	—	—	—	—	—	9	8	—	—	—	—	—	—	—	—
30	30	29	28	27	26	25	24	23	22	21	20	—	—	—	—	—	15	14	13	12	11	10	—	—	—	—	—	—	—	—	—
31	31	30	29	28	27	26	25	24	23	22	21	20	19	18	17	16	—	—	—	—	—	—	—	—	—	—	—	—	—	—	—
32	32	31	30	29	28	27	26	25	24	23	22	21	20	19	18	17	16	15	14	13	12	11	10	9	8	7	6	5	4	3	2

STAR FLEET BATTLES — 32 IMPULSE MOVEMENT CHART

# STARFLEET BATTLES — MASTER PLAYER RECORD-KEEPING FORM

## EVENT RECORD TRACK

TURN					
1					
2					
3					
4					
5					
6					
7					
8					
9					
10					
11					
12					
13					
14					
15					
16					
17					
18					
19					
20					
21					
22					
23					
24					
25					
26					
27					
28					
29					
30					
31					
32					

## SEEKING WEAPON RECORDS

WPN	DAMAGE	WARHEAD

## LOCATION OF MINES DROPPED

## REPAIR POINTS ACCUMULATED

SYSTEM	TURNS	POINTS ACCUMULATED

## GUARD ASSIGNMENTS

## SCATTER-PACK DATA

ID#				
RANGE				
DAMAGE				
LOAD				
TARGET				
PRI/RND?				

## WILD WEASEL MOVEMENT PROGRAM

#				
#				
#				
#				

## RUNNING TOTAL TABLE

## BOARDING PARTIES ON ENEMY SHIP

TURN	START	ARRIVE	LEAVE	KILLED	END
	/	/	/	/	/
	/	/	/	/	/
	/	/	/	/	/
	/	/	/	/	/
	/	/	/	/	/
	/	/	/	/	/
	/	/	/	/	/

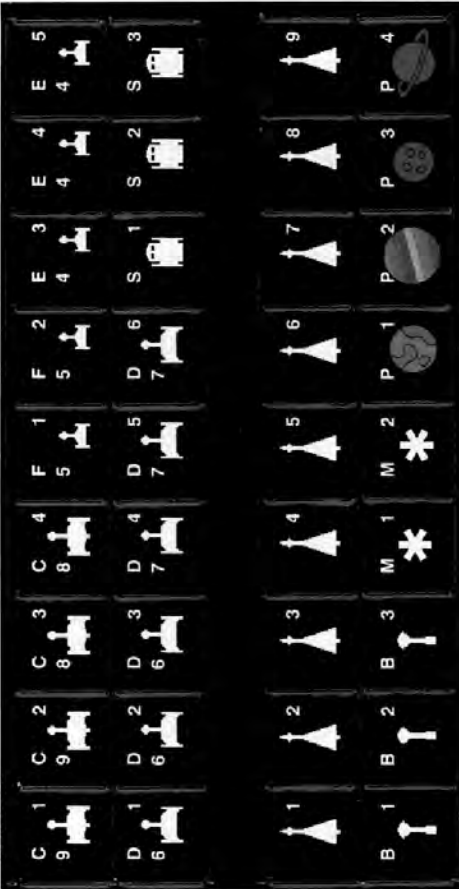

ASTEROIDS

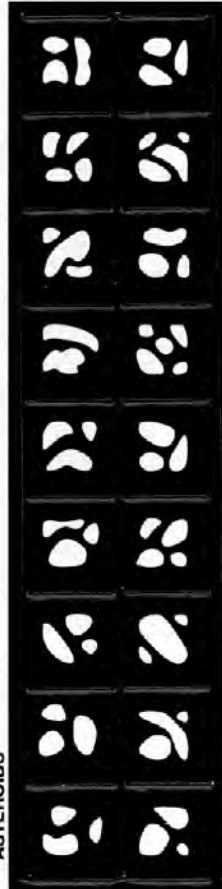

ROMULAN



THOLIAN

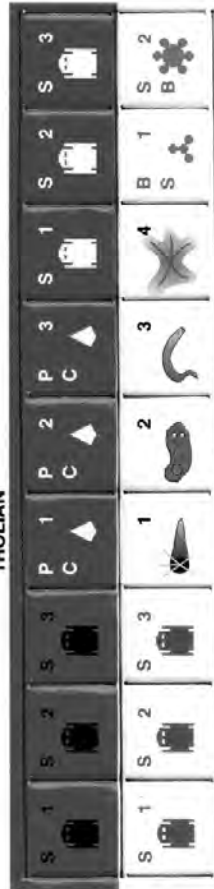

GORN

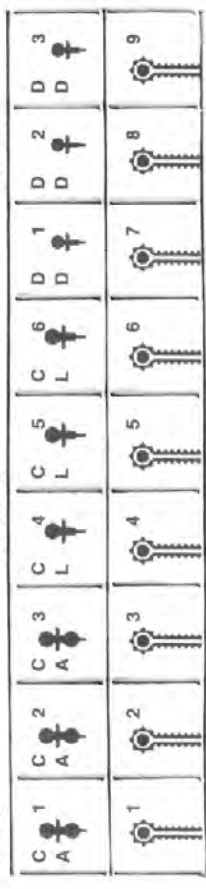

MONSTERS

BASES

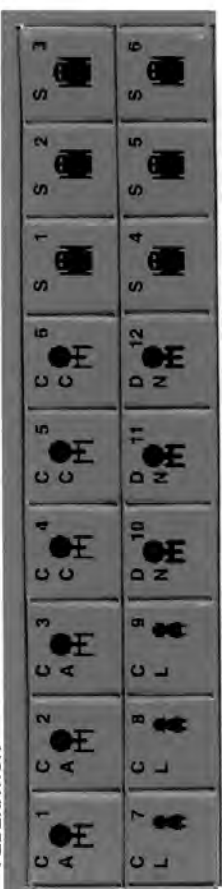

ORION PIRATE



FREIGHTERS

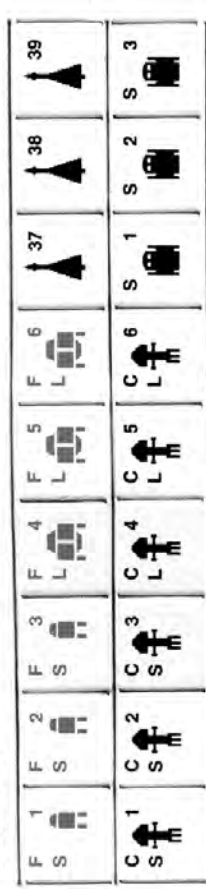

KZINTI

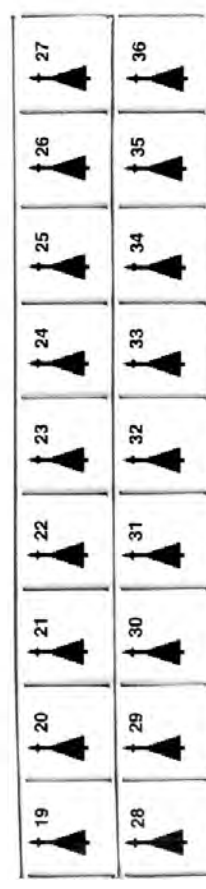
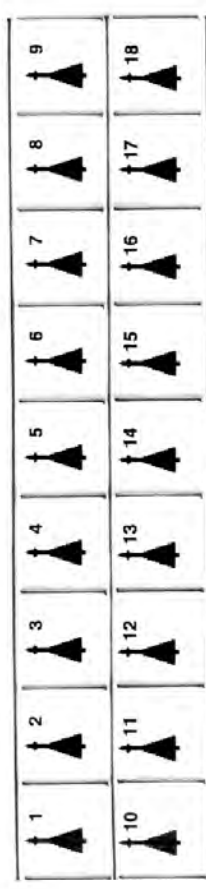



# STAR FLEET BATTLES

## STAR FLEET BATTLES BASIC SET

Command a starship! What you saw on the screen, you can do for yourself. Basic Set is the foundation of the Star Fleet Battles (SFB) game system. Includes Federation, Klingon, Romulan, Kzinti, Gorn, Tholian, and Orion ships and rules. Basic rules on combat, maneuver, weapons, energy allocation, etc. Scenarios send you into deadly space combat. Stock #5501 \$29.95

## STAR FLEET BATTLES ADVANCED MISSIONS

While Basic Set forms the foundation of SFB, Advanced Missions is the core of the game system. Includes more ships. Plus advanced rules such as erratic maneuvers, speed changes, docking, tactical intelligence, passive fire control, catastrophic damage, maulers, advanced drone construction, and more. Plus scenarios and campaigns. Stock #5502 \$29.95

## CADET TRAINING HANDBOOK

Step-by-step instructions teach you the nuts and bolts of commanding a starship. This expanded version of the classic Cadet manual includes more ships, races, and scenarios, allowing players to fight their way into the game. Stock #5620 \$9.95

**MODULE C1 NEW WORLDS I:** The Lyrans (allied to the Klingons), Hydrans (allied to the Kzintis), and WYNs (in their neutral enclave). Dozens of new ships along with new technology (expanding spheres, fusion beams, hellbore cannons, gatling phasers, and stinger fighters) are included. Stock #5601 \$14.95

**MODULE C2 NEW WORLDS II:** The ISC threaten everyone with plasmatic pulsars. Neo-Tholian ships arrive with their web-casters. The devastating Andromedan Invaders sweep the galaxy with tractor-repulsors. Stock #5602 \$14.95

**MODULE C3 NEW WORLDS III:** The Lyran Democratic Republic (gatling phasers), the Seltorians (who hunt Tholians), the WYN Cluster's deadly "fish" ships, and more Andros. Stock #5603 \$19.95

**MODULE C4 FLEET TRAINING CENTERS:** Ships that can fly sideways, wire-guided plasma torpedoes, rotating weapons turrets, and other deadly new challenges. Stock #5616 \$24.95

**MODULE C5 THE MAGELLANIC CLOUD:** The Andros conquer the Baduvai, Eneen, Maghadim, Uthiki, Chomak, and Jumokian Pirates. Stock #5618 Spring-Summer 2003 \$26.95

**TACTICS MANUAL:** A complete primer on everything you need to know to fly a starship to victory! Weapons, maneuvers, energy management, and much more. Stock #5703 \$14.95

**MODULE T TOURNAMENT WARS:** Updated for 2000, this special pack includes the rules, ships, counters, and map needed for the famous SFB Tournaments. Stock #5622 \$24.95

**MODULE TR TOURNAMENT REFERENCE:** All of the rules you need for the tournament (as long as you have Basic Set and Module T). A good introduction to the game system for new players; latest updates to the rules. Stock #5624 \$10.00



## GURPS

### PRIME DIRECTIVE

Role-playing reaches the final frontier. Using the powerful GURPS game engine, this stand-alone manual will allow players to assume the roles of Humans, Vulcans, Klingons, Tholians, Romulans, and dozens of other races. Players can be soldiers, diplomats, spies, reporters, scientists, or even elite Prime Teams.

Rules cover character creation, skills, advantages, Star Fleet History, awards and medals, technology, and adventures. Also included are deck plans for the Prime Trader and data that allows players to engage in space combat with either the Star Fleet Battles or GURPS Space-3 combat systems. Includes the complete adventure RESCUE ON ROON where a group of Federation Star Fleet personnel are pulled together at the last minute to rescue the son of the Federation's Trade Envoy before the Orion Pirates can wreck the negotiations. Stock #8001 \$24.95

## STAR FLEET BATTLE FORCE

At last, an exciting SFB card game in the tradition of naval card games. Players use their ship cards to fire weapon cards at the enemy. Special cards cover damage control, electronic warfare, scatter packs, overloads, and even Klingon Mutiny! This is a stand-alone card game, not one of those endless "collectible" types. One deck is enough for up to six players. Many weapon cards can be used for offense or defense. Plastic markers score your hits, so cards recycle fast!

Plan your strategy and execute your attacks with

132 breath-taking full-color cards. Stock #5911 \$22.95

**STAR FLEET MISSIONS:** Exciting card game for the entire family. Select ships for dangerous missions. Send the best ship and you win ... maybe. Stock #5901 \$5.00

**CAPTAIN'S PIN:** Glorious gold and blue 1.25" hard enamel cloissone design for a "Star Fleet Captain". Stock #5401 \$7.95



**AMARILLO DESIGN BUREAU, Inc.**  
P.O. Box 8759, Amarillo, TX 79114  
Phone 806-351-1950 — Fax 806-351-2585  
sales@starfleetgames.com — www.starfleetgames.com  
Catalog revised July 25, 2002



## MORE MODULES FOR SFB!

**MODULE J FIGHTERS:** Deadly fighters and massive carriers. Rules for escorts, reloading, and special shuttles are included, along with scenarios and campaigns. Stock #5604 \$19.95

**MODULE K FAST PATROL SHIPS:** PFs can carve a cruiser into scrap metal in three turns flat! The punch of a destroyer on a hull smaller than a frigate, with engines just one turn of the wrench short of exploding. Stock #5605 \$19.95

**STELLAR SHADOW JOURNAL #1:** Everything that couldn't happen just did in this shadow of the universe. Heavy PFs, the Peladine race, the original Federation "flatbed" CVA, the warp gyroscope, and more. Also includes impossible material for F&E and Prime Directive. Stock #3601 \$9.95

**MODULE M STAR FLEET MARINES:** Fight anywhere: on the ships, alien planets, or starbases. Rules, scenarios, and special boarding party combat diagrams. Stock #5615 \$21.95

**MODULE X1 THE X-SHIPS:** As close to "magic" as you can get in science fiction, these might as well be flown by Ancient Gods. And now, YOU can fly them. Stock #5612 \$19.95

**MODULE Y1 THE EARLY YEARS:** The first wars of the Klingons, Federation, Romulans, and more. Learn to fight the early ships; meet the Carnivons and Paravians. Stock #5623 \$25.95

**MODULE R1 BASES & AUXILIARIES:** More bases and ships for use by all of the races. Stock #5606 \$17.95

**MODULE R2 FEDERATION REINFORCEMENTS:** More ships for the Federation, Kzintis, Andromedans, and Orions, including many new scenarios. Stock #5607 \$17.95

**MODULE R3 KLINGON REINFORCEMENTS:** More ships for the Klingons, Lyrans, Hydrans, and WYNs, including many new scenarios. Stock #5608 \$17.95

**MODULE R4 ROMULAN REINFORCEMENTS:** More ships for the Romulans, ISC, Gorns, and Tholians, including many new scenarios. Stock #5609 \$17.95

**MODULE R5 BATTLESHIPS:** The most massive ships ever to trek through the galaxy blast their way onto your game board. Includes scenarios. Stock #5610 \$18.95

**MODULE R6 THE FAST WARSHIPS:** Fast cruisers, mobile carriers, police flashships, and new scenarios. Stock #5617 \$23.95

**MODULE R7 DREADNOUGHTS AT WAR:** Heavy Dreadnoughts, Light Dreadnoughts, Early Dreadnoughts, Dreadnought Variants, Stellar Domination Ships, and Battleship Carriers. Plus scenarios and a campaign. Stock #5621 \$18.95

**MODULE J2 ADVANCED FIGHTERS:** More than 60 new ships (Patrol Carriers, Scout Carriers, Interdiction Carriers, special carriers) plus new fighters! Stock #5619 August 2002 \$21.95

**MODULE S1 SCENARIO BOOK I:** 50 scenarios and 2 campaigns portraying the glory of victory and the shame of defeat. Stock #5704 \$9.95

**MODULE S2 SCENARIO BOOK II:** Another 51 dramatic battles, plus the Survey Ship Campaign. Stock #5707 \$9.95

**CAMPAIGN DESIGNER'S HANDBOOK:** Build your own galaxy and run a campaign in it. Technology, economics, construction, supply, intelligence, it's all covered. Several options for each rule so you can customize your galaxy. Stock #5715 \$14.95

**MODULE W SPACE BATTLE MAPS:** Stock #0020 \$13.95

## THE OMEGA SECTOR

### MODULE Ω1 THE OMEGA SECTOR

Beyond the Void, Behind the ISC, lies... OMEGA! A new sector of the galaxy with 11 new races, 24 new weapons, and 18 new wars. Stock #5661 \$24.95

**MODULE Ω2 OMEGA REINFORCEMENTS:** More ships, bases, and fighters for the original 11 Omega races. Stock #5662 \$21.95

**MODULE Ω3 THE OMEGA WARS:** Six more new races with dozens of new ships and weapons. Stock #5663 \$21.95

**MODULE Ω4 THE OMEGA REBELLION:** Four more new races, and more for the whole sector! Stock #5664 \$21.95

**MODULE Ω5 OMEGA SQUADRONS:** More ships for the entire Omega sector! Stock #5665 Release in 2003. \$23.95

## CAPTAIN'S LOG

More than a magazine, each issue of Captain's Log brings players new ships, playtest rules, tactics, scenarios, convention news, product schedules, updates, and the answers to their questions. Each issue includes new tactics, rules, and more for F&E. Regular features cover SFB On Line, PBEM, and Star Fleet Command. Every issue has been a top seller around the world.

**CAPTAIN'S LOG #24:** This issue explores The Middle Years and the 2nd Fed-Kzinti War (Y136). The Kzintis launched a two-pronged attack, hitting *Flashpoint Mantor* and the *Sideshow at Cygnus*. Plus many new ships, scenarios, and tactics. Stock #5724 \$16.95

**NEW ISSUES BY ADB, INC.** (Each is 112 pages, \$14.95)

CL#18: Three fiction stories, two new races. Stock #5714

CL#19: Kzinti History of the General War. Stock #5719

CL#20: Three monsters, new ships, and more. Stock #5720

CL#21: Nine scenarios, 18 new ships, and more. Stock #5721

CL#22: Eight scenarios, 17 new ships, and more. Stock #5722

CL#23: Six Scenarios, 19 new ships, and more. Stock #5723

## FEDERATION & EMPIRE

Strategic companion game to SFB; players rule mighty galactic empires. Each player must collect taxes, buy ships from shipyards, pay for special combat bonuses, organize fleets, seek out the enemy, and hammer him into submission! While huge, the game system is relatively simple. Rules, charts, 1,400 counters. New 2000 Edition. Stock #5006 \$49.95

**CARRIER WAR:** Adds special carrier rules to F&E, including the ability to customize your carrier groups. Stock #3205 \$19.95

**SPECIAL OPERATIONS:** Adds special rules to F&E, stasis field generators, LTTs, electronic warfare. Stock #3206 \$9.95

**MARINE ASSAULT:** Ground combat and commando ships for F&E. Stock #3208 \$14.95

**ADVANCED OPERATIONS:** The first new F&E expansion in six years will bring X-ships, PF mech links, and dozens of new ships into the game. Stock #3209 Oct 2002 \$29.95

## STARLINE 2400 MINIATURES

Precise scale miniatures of Star Fleet ships!

\$7.95: Fed Old CL, BC, DW, NCA; Klingon D7, C7; Romulan SP, FH; Kzinti BC, CM, Gorn BC, BDD, BDX; Hydran Ranger

\$14.95: Fed NCL+FF; Klingon D5+F5, F6+E4, E5+E7; Romulan SK+SEH; Kzinti DW+FF, CVE+DD; Gorn CL+DD; Tholian CW+PC; Hydran CW+DW; Lyrans, Andros, Orions coming soon.

\$15.95: Tholian CA+NCA.

\$39.95: Fleet boxes for Feds, Klingons, Romulans, Kzintis, Gorns, Tholians, Hydrans, ISC; Lyrans, Andros, Orions coming soon.

# STAR FLEET BATTLES

## CAPTAIN'S BASIC RULEBOOK



Made in USA — 1999

ADB  
INC.

# STAR FLEET BATTLES

## CAPTAIN'S EDITION BASIC SET

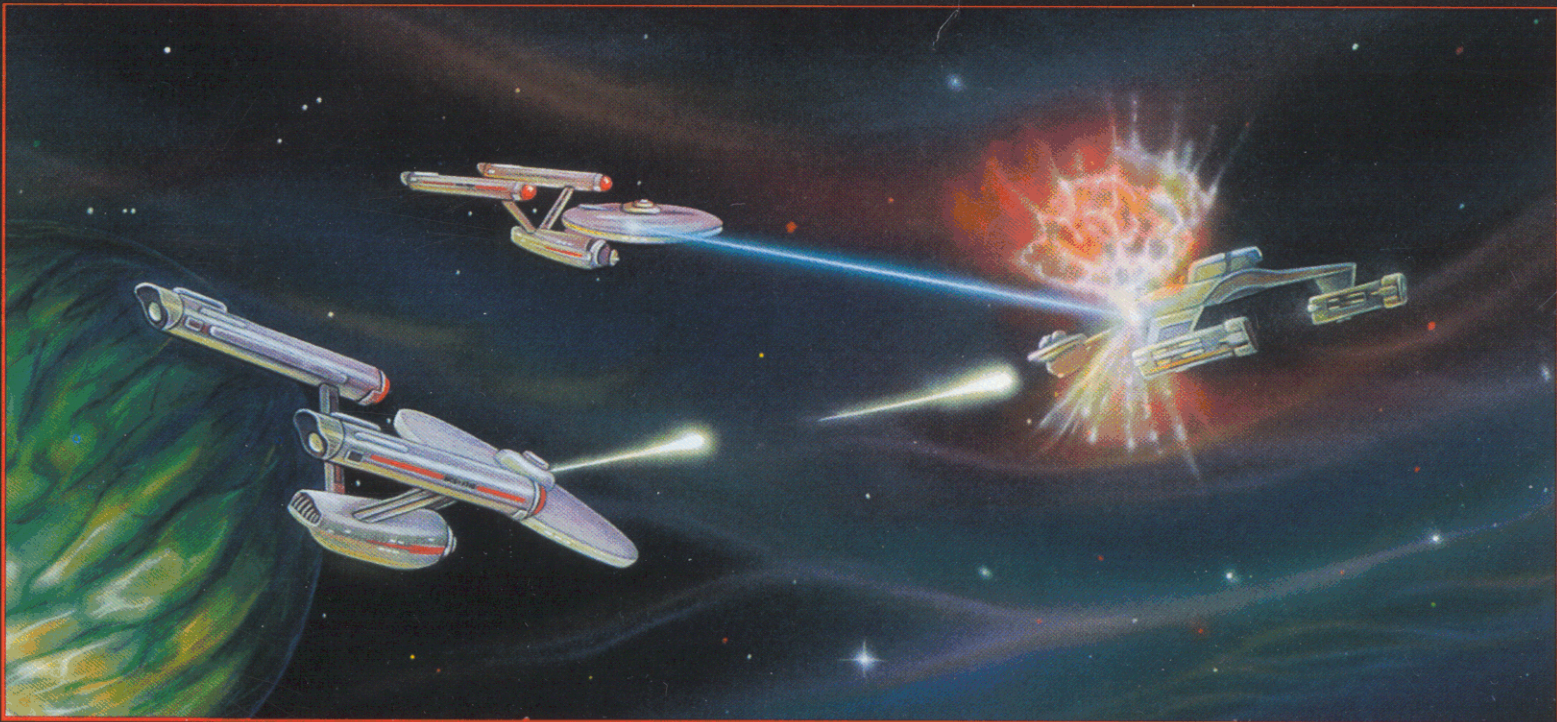

**ENEMY STARSHIP ON SCANNERS! LOCK PHASERS ON TARGET! ENGAGE!**

**ACCEPT THE CHALLENGE OF STARSHIP COMMAND!** Out-think, out-shoot, and outmaneuver your opponent in a warp-speed dogfight. Your crew's lives depend on your skill and cunning as you bring your strongest shields and most powerful weapons toward your enemy...an enemy that might be another starship, a massive robot berserker, or an alien being so huge it dwarfs your mighty ship.

**CAPTAIN'S EDITION BASIC SET** is the foundation of the exciting and detailed Star Fleet Battles game system. It is also a complete starship combat system that stands alone.

**SEVEN GALACTIC EMPIRES**, the Federation, Klingons, Romulans, Kzintis, Gorns, Tholians, and Orions, send their best ships and crews on missions of exploration and conquest. More than 50 classes of starships are represented.

### COMPONENTS INCLUDE:

- 224-page Captain's Rulebook (with introductory rules included)
- 24" x 20" full-color map • 216 die-cut multi-color playing pieces
- 64-page SSD Book which includes a 16-page starter pack and all charts and tables
- 11" x 17" card with Damage Allocation, Movement, and Energy Allocation Tables

**NUMBER OF PLAYERS:** Two or more

**AGE:** 12 and older

**PLAYING TIME:** One hour and up

**DIFFICULTY:** Moderate to complex



Now Published by ADB, Inc.  
Box 8759, Amarillo, TX 79114  
806-351-1950; fax 351-2585  
[www.starfleetgames.com](http://www.starfleetgames.com)



**STOCK #5501**  
**MADE IN USA**