

The Star Frontiers Article Collection  
from Imagine Magazine



TITLE	SUBJECT	SOURCE
<a href="#">Aramax One</a>		<a href="#">Imagine 4</a>
<a href="#">The East Indiaman Class Freighter</a>		<a href="#">Imagine 18</a>
<a href="#">On the Rocks</a>	SF mini-module	<a href="#">Imagine 18</a>
<a href="#">The Sarafand File</a>		<a href="#">Imagine 29</a>
<a href="#">The Fire Opal of Set</a>		<a href="#">Imagine May 89</a>

*STAR FRONTIERS, WIZARDS OF THE COAST, and the WIZARDS OF THE COAST logo  
are trademarks belonging to Wizards of the Coast, Inc., a subsidiary of Hasbro, Inc.,  
and are used with permission. (c) 2001.*

*Imagine Magazine, the Imagine Magazine logo, and Star Frontiers are all trademarks of TSR UK Ltd.  
Article listing courtesy of Timothy R. Norris*

---

# ARAMAX ONE

by John Tantoblin

This is a STARFRONTIERS™ adventure module, and you must have a copy of the STARFRONTIERS expanded game rules to play it.

If you are going to be a player stop reading here. The rest of the information in this module is for the referee alone.

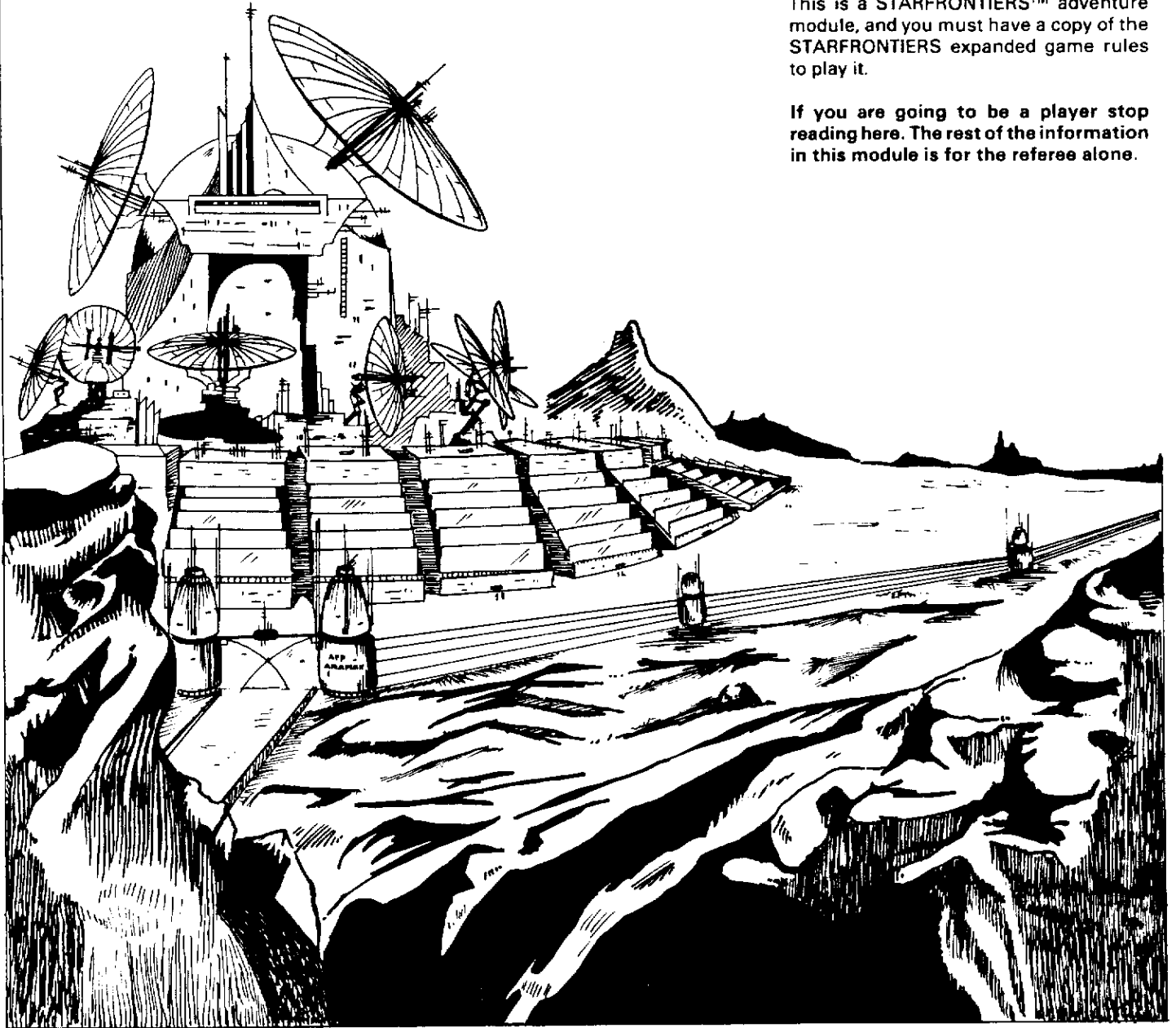

This module has been designed for a group of three to five characters. Ideally, these characters should not be newly generated, but should have already earned (and spent) experience points improving their skill levels. Pre-experienced characters are provided in this module, and the referee should compare these with any characters that the players may wish to use.

## Preface

ARAMAX ONE is set on Triad in the Cassidine star system. Triad in Cassidine is one of the trade and industrial centres of the Frontier, generally referred to as

one of the Hub Worlds. Nearly all the large corporations have offices and production facilities on planet or in close orbit.

There are several smaller corporations with facilities on Triad and in orbit. All of these companies are limited to the Cassidine system at present, but are attempting to expand their activities outsystem.

Aramax Power Factors (APF) is one of these smaller corporations, with interest in a number of fields including mining, shipping and, of course, power generation and distribution. At present the company supply over half of Triad's power require-

ment, but its main competitor, Sunpower Inc, is attempting to expand its market share.

APF Ground Site One (ARAMAX ONE) is the collection array for a system of solar power satellites which supply the industrial belt round Triad Low Starport.

Aramax One is also the site of APF's central computer. It organises the power distribution network, the maintenance of the collection arrays and satellites, and handles the company record keeping. Although the company has other computers at its other offices and facilities, the Aramax One machine is vital to the running of the company.

## I. Background

Before beginning play the referee should read this module to become familiar with the outline of the adventure, and the details presented in its various sub-sections. All the information relating to a specific topic (eg the Computer) is presented in a single boxed section. This information is for the referee only. General information, such as room contents, is given in the main body of the module. Some of the information is indented and printed in a different face and this may be read to the players at the relevant times.

Apart from combat skills, the characters will also require a good range of other skills, mostly of the 1st and 2nd level. Computer, Robotics, Technician and Medical skills should be available to have a reasonable chance of success. One of the characters must have at least 1st level Demolitions skill.

### Player's Background

The referee should read the following to the players at the start of the adventure:

Early one evening, while you are sitting in a bar near Triad Low Starport drinking your last few credits away, you are approached by a new, obviously expensive, cybot. The machine quietly asks

you to accompany it to see its master, who has a job you may be interested in.

It leads you into a dimly lit room behind the bar. Partly hidden in the shadows is a middle-aged vrusk. As you sit down the vrusk switches on a small device. The cybot gives each of you an envelope, and the vrusk begins to speak in a heavily distorted voice:

'Good evening, gentlebeings. In each of the envelopes you will find Cr.100. This is a consultancy fee. As such it also buys your silence about this conversation.

'I have a small task for you. It involves some personal risk, but you will be adequately compensated.

'About five kilometres south of here is the local collection array for the solar power satellite system. It is owned by Aramax Power Factors — APF to their friends and enemies. APF also use the site to house their central computer; it holds all their records, and virtually runs the company from day-to-day. I, for reasons of my own, want the computer destroyed.

'If you are willing to break into the site and do this, you will have more than my gratitude. Your total fee will be Cr.5,000, half now and half on completion. This is enough to buy you all tickets on the next starship to leave Triad, no matter where it is going. I can also offer some material

aid to you — transport, weaponry, tools and explosives. All you have to supply are the skills to do the job.

'There is one proviso. You must do the job tonight. It has been arranged that only five or six guards, instead of the normal squad of twelve, will be on duty, and none will be heavily armed. All the night staff will have been sent home.'

The cybot gives you an envelope. Inside are five bundles of banknotes, all used, amounting to Cr.2,500. It also gives you a groundcar key, and a security pass bearing the legend *APF Security Central*. The vrusk then continues:

'Your money. The car outside contains all your equipment and a roadmap showing your target. The pass card should get you past the outer gates and into the building. After that you are on your own.

'And finally, don't try to take the money and run. The rest of your pay will be waiting with my cybot at the starport. There is a shuttle at 0800 tomorrow, and a starship to Prenglar is waiting. I am rich and well connected, if you do try to cross me — vengeance is easy for someone in my position.'

The vrusk gets up, and with a curt gesture to his cybot, he and it leave the room and disappear through the back door.

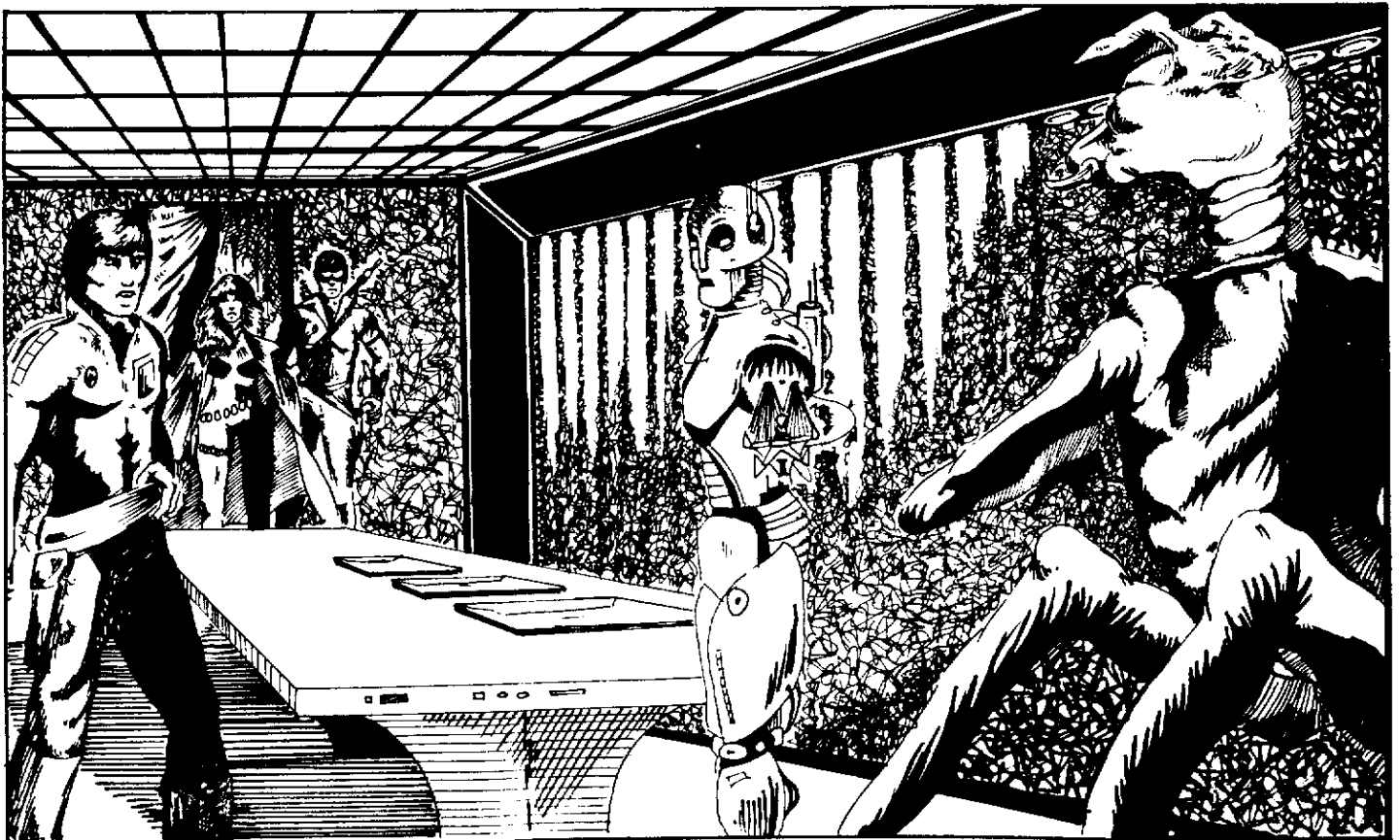

## Referee's Background

The story told to the party by the vrusk is true, but incomplete.

The vrusk failed to identify himself. He is *Max* Kejganokh no Kami — like many vrusk he normally gives his company name first. Kejganokh is the sole owner of Aramax Power Factors, and is therefore a success in vrusk society. His reasons for wanting his own property destroyed stem directly from his esteemed position.

Two days ago, while running a financial analysis program on the Aramax One computer, Kejganokh discovered that payments totalling Cr.601,000 had been made to a number of non-existent subcontractors. Further investigations revealed that the payments had been made on the authority of APF's Operations Manager, a human called Fiona Talenc.

Kejganokh could not report the theft. As a vrusk, a member of a race which prides itself on its business expertise, to be the victim of blatant commercial theft was bad enough, to admit to being such a victim was unthinkable. If knowledge of this crime became public Kejganokh would lose face in the eyes of his fellow vrusk, and his company would lose status. Cursing himself for hiring a human in the first place, he resolved to deal with the matter as secretly as possible. Thus, after gathering what equipment he could from company stores, altering the guard rosters and raiding the petty cash, he approached the party. He carefully disguised his voice and remained in the shadows to prevent recognition by his new hirelings.

However, Kejganokh's behaviour has not gone unnoticed. Fiona Talenc spotted his increased use of computer time, and rapidly realised that her fraud had been uncovered. Surprised by the non-arrival of the police with a warrant for her arrest, she decided to take matters into her own hands. Converting her ill-gotten gains from credit accounts to cash and easily transportable valuables she prepared to flee on the next available starship, but before leaving Fiona decided to destroy the evidence at Aramax One.

Fiona has hired a group of mercenaries to attack the Aramax One site, posing as terrorists. She hopes that this will allow her to escape off-planet during the resulting misdirected investigation. This was to have taken place yesterday, but she discovered that the guard rosters had been changed and rescheduled the attack for tonight. She and her henchmen have unlocked Aramax One while Kejganokh was talking to the party.

The adventure begins after the party have taken the waiting groundcar and driven to Aramax One. As they arrive at the Main Gate the site is quiet, although some lights are on in the main building.

## The Ground Car & Other Equipment

The ground car that Kejganokh has supplied to the party has been taken from APF's motor pool, and the theft hidden by manipulating the computer records. It is a standard model (see Expanded rules p.29), and still has power for 400km at cruise speed.

In the boot is the equipment that Kejganokh was able to remove from various APF stocks:

Three Automatic Pistols, with two ammunition clips (40 rounds) each. One Laser Pistol, with a depleted power clip (15 SEU remaining). One Electrostunner, without a power clip. One Grenade Rifle, with one Doze grenade and two Tangler Grenades. One Machine Gun and Tripod, with two ammunition belts (400 rounds).

One Medkit, as defined on p.45 of the Expanded rules. One partial Techkit, which does *not* contain the following: jack, nuts, bolts, screws, and spray waterproofing.

Two kilograms of Tornadium D-19, with a variable timer/detonator.

Three fully charged 20 SEU power clips.

The Referee should note that Triad's gravity is higher than standard 1.1g — and that any character who chooses to take the machine gun will be encumbered in the confined space inside the building, regardless of that character's strength.

Furthermore, the machine gun must be properly mounted on the tripod to fire without penalty. This takes two turns. Firing the machine gun 'from the hip' is possible, but in this adventure a penalty of -60% is accrued.

The security pass card that the party have been given is better than they have been told. Due to an error in Kejganokh's programming the card will open any door in the APF facility, rather than just the main gate.

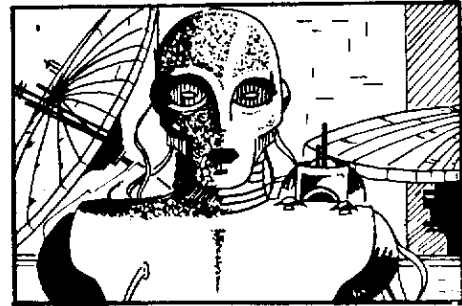

## II. The Building

The only building on the Aramax One site is detailed below.

Unless noted otherwise all doors in the building are controlled by card activated locks located next to them. Certain cards are not valid for some of the doors in the facility (eg Security cards will not open the archives).

The construction standards of the building vary slightly. As far as structural damage points are concerned the walls and doors are constructed to the standards given on p.25 of the Expanded rule book. The archives (room 13) are constructed to vault standards.

### 1. The Perimeter Fence, Main Gate and Car Park.

The whole of the Aramax One site is surrounded by a monitored, chainlink fence, some 3m high. There is only one access point, on the north side, where the road is blocked by a powered sliding gate.

The Referee should read the following to the party when they arrive at the gate:

At this point the perimeter fence is broken by an access road through a large gate. The gate is wide enough to take a hover truck with ease. It is closed.

On the right hand side of the gate, at a height of 1m, is a cardlock.

Beyond the gate is the building, with a carpark in front of it. Several vehicles and two ground cycles are parked there.

The cardlock controls the gate. The security card Kejganokh gave the party will open the gate without any problems, but the fact will register on the computer terminal in the security office (room 3).





If the party decide to break through the perimeter fence, and fail to deactivate the monitoring system, the main computer will dispatch a security robot (see the relevant boxed section) to investigate.

Once inside the compound the party is in the spacious car park. Six vehicles are parked here; three ground cars in APF livery, two private ground cars and a sports-type hover car. The ground cycles are in APF livery and bear Security flashes.

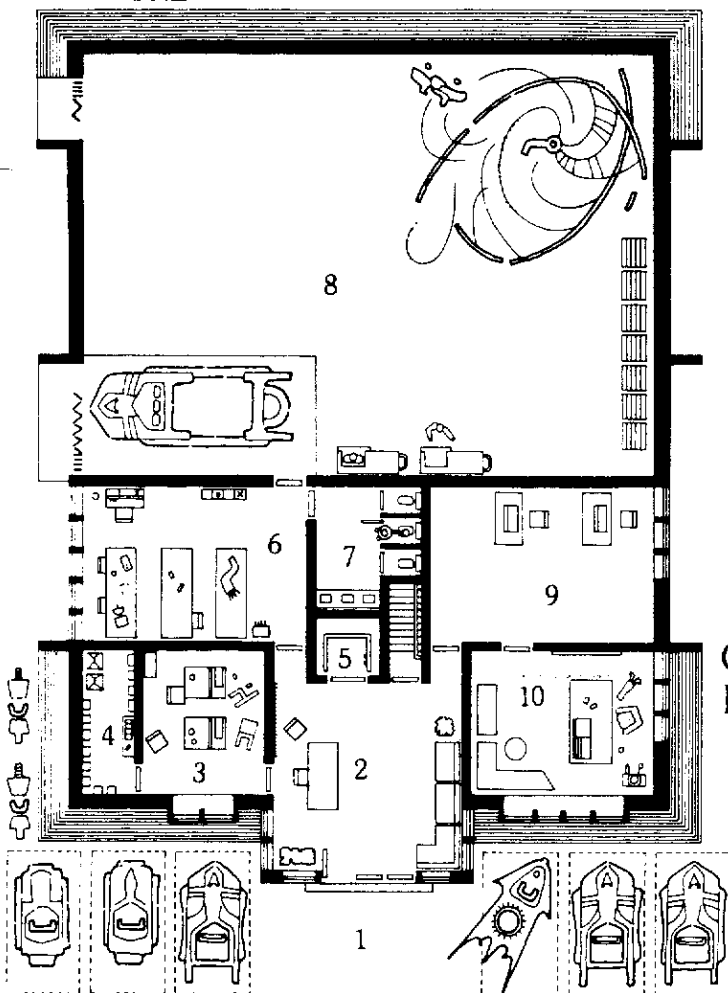
Only the hover car is unlocked. This is Fiona Talenc's personal vehicle, and it has been booby-trapped by Kejganokh. Under the front seat is a 200g explosive charge, linked via a timing device to the ignition system. The bomb is set to explode after another 3 minutes of driving time, causing 5d10 + 75 points of damage to all those within the car.

# ARAMAX ONE



-  Wall
-  Door
-  Windows
-  Sliding Doors

1 2 3 4 5 Scale (metres)

GROUND LEVEL

BASEMENT

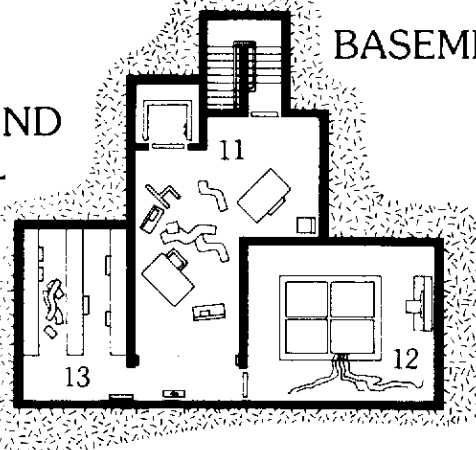

## Security



All the doors on the site are controlled by card activated locks (security device level 1), which the security program monitors. If any door is opened without the correct card (by the failure of a character Deactivating Alarms/Defences) the computer displays the fact on the security office terminal(s), and notes the time. Theoretically the security personnel then carry out a manual investigation.

All the security guards normally carry security cards which will open any door except those to the site manager's office and the computer archives.

The outer fence is also subject to monitoring by a simple electrical circuit (security device level 1). Should the fence be broken, the computer will despatch a security robot to investigate the breach and inform the security office. Inside the site there is a network of pressure sensors (security device level 2), but these have never been used and are now unserviceable. However, the players should not be told this if they discover the network and attempt to deactivate it.

The left hand front door of the building is standing open.

## 2. The Reception Area

This is the entrance hallway. The furniture, three couches, a desk and a pair of chairs, is of an opulent standard. The walls are hung with a number of holograms showing images of satellites, deep space mining equipment, and one shows a distinguished business vrusk.

Opposite the main entrance are a set of lift doors. There is only one button, with a downward arrow on it.

If any character carefully examines the picture of the vrusk, and makes an Intuition check, he or she should realise (ie the player should be told by the Referee) that this vrusk has been seen before. The hologram is a portrait of Kejganokh no Kami, and is labelled as such. The label also gives Kejganokh's position as owner of APF.

The Referee should feel free to invent other items of interest, such as magazines, for the room.

## 3. The Security Office

The only lighting in here comes from two small desktop lamps. However, you can see that a struggle of some kind has

occurred in here. Two of the chairs have been overturned and a set of playing cards is scattered across the floor.

Only one of the two computer terminals is working. The broken one has had a cup of coffee poured into it. The working one has some kind of time sheet display on its screen.

A few half drunk cups of coffee stand around on the desks and floor.

This is the security office. The normal occupants are now locked in the toilets (room 7).

Any member of the party who makes an Intuition check should be told that there is a small blood stain, from the wounded guard, next to the broken terminal. The coffee in the unspilt cups is only tepid.

The working computer terminal is linked to the Installation Security program. The display shows a list of recent incidents at Aramax One as the security program interprets them. Included on this are the recent arrival of Fiona Talenc, APF's Operations Manager, the arrival of an unscheduled hover truck, and an unauthorised entry into the computer archives (room 13). Depending on the party's earlier actions the display will also show the entry of a security detachment through the main gate, or the despatch of a security robot to investigate a breach in the outer fence.

**Fiona Talenc & The Mercenaries**

Name	STR/STA	DEX/RS	INT/LOG	PER/LDR	IM	RW	M
Fiona	40/60	70/50	75/55	70/50	5	45	35
Civilian Skeinsuit (50 points), Laser Derringer*. Skills: Beam Weapons 1, Computer 3.							
Mercenary 1	25/50	55/35	55/55	45/45	4	38	38
Mercenary 2	35/60	40/20	50/50	40/40	2	30	30
Mercenary 3	55/75	65/45	45/55	35/35	5	43	43
Mercenary 4	30/55	65/45	40/40	60/60	5	43	43
Military Skeinsuit (50 points), Laser Pistol, Vibroknife, three 20 SEU powerclips. Skills: Beam Weapons 1, Melee Weapons 1.							
Mercenary 5	25/50	65/45	30/30	55/55	5	43	33
Mercenary 6	60/85	40/20	35/35	50/50	2	30	20
Military Skeinsuit (50 points), Auto Pistol, one spare ammunition clip. Skills: Projectile Weapons 1, Demolitions 1 (Mercenary 6 only).							

Fiona and her troops arrived at Aramax One while Keiganokh was interviewing the party. Their transportation, a hover truck, is now parked in the loading bay section of the warehouse. Fiona Talenc used her own skimmer (now parked in front of the main entrance). Fiona has had to take part to get the mercenaries into the site, using her security pass card.

As a group they have the following equipment: six security pass cards (taken from the guards), 2.5kg of Tornadium D-19, three variable timer/detonators.

The mercenaries will fight bravely and efficiently within reason. If they are likely

to be killed they will surrender, and, being honourable men, will not violate any terms of their surrender.

The Laser Derringer that Fiona Talenc carries is a non-standard item. Designed as a small 'last resort' weapon, it is made to be used and thrown away. It does not have a replaceable powerclip; this is built into the weapon. As a result the derringer can only fire at two settings: two 4d10 shots or one 10d10 shot. If the lower setting is chosen the second shot will be the same. It cannot be recharged; the laser crystal burns out when used. Several corporations build models, but the BYK Disposable Laser is most popular.



Weapon:	Damage:	Rate:	Defence:	PB:	Short:	Medium:	Mass:	Cost:
Laser Derringer	4d10/10d10	2/1	Albedo	0-2	3-8	9-15	.25	750

The referee should feel free to invent other, worthless items for this room.

**4. The Security Store**

This is the equipment locker for the duty guard detachment. A dozen sets of weaponry/equipment hang from the walls, and a stack of powerclips and a recharger are on a shelf next to the door.

In the far corner of the room are two unopened boxes.

Each set of weaponry/equipment is identical and consists of the following:

- One Electrostunner (without powerclip) and holster
- One Stunstick (without powerclip) and holster
- Two Tangler grenades
- One Flashlight
- One modified Chronocom (this model only has a range of 1km)

The unopened boxes contain two brand new Sonic Stunners, still in their original wrappings and, of course, without powerclips.

There are 29 powerclips in total. The recharger is a unit capable of repowering five 20 SEU clips at one time, taking 30 minutes to do so.

**5. The Lift and Stairs**

The lift is the normal means of descending to the computer in the basement, though the stairs are provided for use in an emergency. The lift is capable of carrying eight humans or the equivalent (up to four vrusk), and has only two floor selection buttons.

The mercenaries have neither booby-trapped nor planted monitors on them. They are of the mistaken belief that they will hear anyone using either method to enter the basement.

**6. The Technical Workshop/Office**

The lights are on in this room, illuminating what is obviously a combination of light repair shop and office space. Various tools, and robotic/computer components, are scattered across most of the available table space in the room — as well as a good part of the floor.

Sitting at the only computer terminal desk is a man in para-military uniform.

This is the repair facility at the site for minor electronic repairs to the robot controls of the power array elements. Major repairs have to be carried out in the field.

The man sitting at the computer terminal is mercenary 1. He has been assigned to guard the prisoners in the toilets (room 7), but has started playing a computer game instead (using the Communications programme on the main computer). He is so engrossed that the party will automatically surprise him. If a fight breaks out the remainder of the mercenaries (in rooms 12 and 13) downstairs will not know of it. The guards held prisoner in the toilets will hear the fight, but will be unable to do anything about it.

Once the mercenary has been subdued or captured the party may search the room. The tools in the room amount to two complete techkits and a robcomkit. Various broken robot components are also scattered about. The game that the mercenary was playing was an adventure-style one: B 4073 'The Secret Temple under the Lost Caverns beyond the Forgotten City of the Forbidden Mountains of the Remembered Horrific Lair of the Ancient Ones (part 2)'.

There is nothing else of interest in the room.

**7. The Toilets**

These are obviously the toilets. Sprawled on the tiled floor, gagged and bound, are two vrusk and four humans. All wear

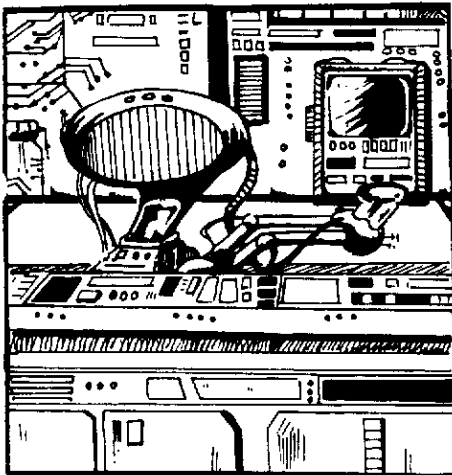

The computer at Aramax One controls the entire power collection array at the site and supervises the distribution of the energy. The computer also carries out a number of standard accounting functions, and it is these that Fiona Talenc has manipulated to her benefit.

The computer runs the following programs: Analysis 5, Bureaucracy 4, Commerce 4, Communication 1, Industry 4, Information Storage 5, Installation Security 2, Maintenance 4, Robot Management 6. As a result the computer is a level 5 machine, massing 300kg, requiring 300 or more points of damage to destroy it.

The computer runs the power collection array through the Industry and Robot Management programs. Each element of the collection array is a self-contained dedicated robot system, which takes its overall orders from the Industry program via the Robot Management program. If the computer should fail the individual robots can keep the power arrays aimed at the solar power satellites for a short time, until central control can be re-established. The various programs of the computer system can be accessed from any terminal in the building. The only program which cannot be accessed from any terminal is the Installation Security program. That program can only be accessed from the terminals in the security office, and from the terminals in the computer room.

All communications, including the internal and external telephone lines, are handled by the Communications program. It is possible to manipulate this program and jam all communications with the outside world from any terminal in the building.

Computer skill may be used with the standard chance of success to manipulate the Information Storage, Analysis or Commerce programs. Success indicates that Fiona Talenc's previous theft/ manipulation has been discovered (ie that Cr.601,000 are missing), but not who is responsible.

## Personnel

Name	STR/STA	DEX/RS	INT/LOG	PER/LDR	IM	RW	M
Sgt. Gomer V	50/45	45/30	50/50	45/45	3	43	33
Military Skeinsuit (50 points). Skills: Beam Weapons 2, Melee Weapons 1, Medical 1.							
Guard 1	60/10	45/50	40/50	55/50	5	33	33
Guard 2	50/40	60/60	45/35	30/30	6	40	40
Guard 3	50/50	50/50	70/70	45/45	5	35	35
Guard 4V	40/50	50/50	45/45	45/45	5	35	35
Guard 5	65/65	50/50	25/35	60/50	5	35	35

Military Skeinsuits (50 points, Guard 1 15 points remaining). Guard 3 has a vibroknife (with a fully charged 20 SEU power clip) hidden in his left boot. Skills: Beam Weapons 1, Melee Weapons 1.

V = Vrusk, all other guards are human.

Normally there are twelve guards at the Aramax One site. However, Kejganokh has manipulated the computer assignments so only six guards are present.

Fiona Talenc and her mercenaries have captured the guards, tied them up, and locked them in the toilets (room 7), though not without seriously hurting the first guard. She has been ministered to by Sgt Gomer and locked up with the others.

If the guards are released by the party they will appear suitably grateful, but will,

at the earliest opportunity, arm themselves with laser pistols from the security store (room 4) and attack. Fiona Talenc and her mercenaries will be treated as preferred targets. If communications with the outside world are still possible, Sgt Gomer will contact the police and ask for assistance.

If the police *are* called, the course of events is entirely up to the Referee. If the police arrive while the party is still at the Aramax One site, the adventure is effectively ended.

APF company uniforms with Security brassards. One of them, a woman, has been wounded.

In the centre cubicle a maintenance robot is busily polishing the plumbing.

The six people who have been tied up are the APF security personnel (see the relevant section). It is guard 1 who has been wounded in the skirmish when Fiona and the mercenaries arrived. The Referee should note that this guard will suffer the 'Attacker Wounded' penalty in any combat situation.

The robot is a simple-minded maintenance machine (see the relevant boxed section), incapable of following any but the simplest verbal instructions. It is not capable of following even these if they conflict with its pre-programmed function as ordered by the Robot Management program of the main computer. It is thus ignoring the guards, because — logically — they do not exist. It is also incapable of carrying out any aggressive actions or defending itself.

## 8. The Warehouse

This warehouse space is largely empty. In one corner stands an incomplete power array element. Next to that is a ground cycle without any wheels. A stack of crates stand against one wall. By the smaller door is a pair of robot recharging stations.

In the warehouse loading bay a large, commercial hover truck with an APF logo on the side has been parked and left unlocked.

The warehouse space is used entirely for temporary storage of power units before and after installation on the grid. The power array element which is in here at the moment is awaiting removal to the scrapyard.

The ground cycle parabattery is completely discharged.

The eight crates hold general electronic and small technical spares for the power array. The hover truck has been stolen from another APF facility and used as transport by the mercenaries. They intend to use this vehicle for their getaway. It still has power for 900km.

The robot recharging stations will be occupied by either one or two security robots, — the exact number depending on whether or not the party has encountered a robot (eg if the party entered the Aramax One site by breaching the outer fence). See the relevant section for details of the robots.

## 9. The General Office

This darkened office space contains little of interest apart from two desks, both with computer terminals standing on them. These terminals are switched off.

**Robots**

Robot	MV	IM/RS	STA	ATT	DM	SA	SD
Security 1	90	5/50	100	50	-	2 Tangler Grenades	Inertia Screen
Security 2	90	5/50	100	50	-	2 Doze Grenades	Albedo Screen
Programs: Restrain							
Maintenance Service	60	4/40	100	-	-	-	-
	30	7/70	100	-	-	-	-

There are normally four robots at the Aramax One site which are not in control of a section of the power array. All the robots are under the control of the Robot Management program on the computer. The robots listed above are the mobile ones used for various purposes around the facility. No statistics are given for the power array robots, as these are dedicated

machines which are not capable of taking any independent action.

Only the security robots are capable of taking any aggressive action. The computer will despatch one of them to investigate any breach in the outer fence and restrain those responsible. If one robot fails the other is sent.

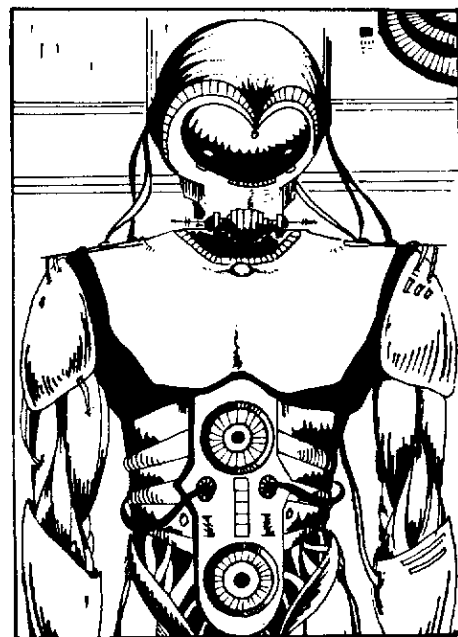

This office is rarely used in the normal course of business at Aramax One, because most administrative functions for the facility are carried out by the main computer. As a result this room is rather spartan.

The Referee should feel free to invent any worthless items of interest for this room.

**10. The Site Manager's Office**

This is a luxuriously appointed office space. On a large desk sits an executive computer terminal. Behind the desk is a leather chair designed for a human, with a set of golf clubs resting against it. The other furniture in the room — a pair of low couches and a low table — are of similar high quality.

In one corner stands a service robot.

There is little of relevance to the adventure in here. By the computer terminal are stacked a number of computer games modules. There is no documentation of any kind, all hardcopy being produced in the computer room.

The service robot (see the boxed section for details) has been deactivated. If reactivated it is incapable of carrying out any aggressive or defensive actions at all.

**11. The Computer Office**

Regardless of whether the party uses the lift or the stairs to descend to the basement the view that they have of the scene is as follows:

Although the lights in this office are on, the room has a bluish tinge, due to the pall of smoke and fumes which hang in the air. In the far right hand corner of the office small flames, and the occasional spark, are guttering from the remains of a cardlock. The door next to it is open.

In the corner by the stairs lies the body of a vrusk in APF company work uniform. He has been shot several times by laser and automatic weaponry.

The rest of the office is a shambles. The two desks in the room have been emptied and their contents — mostly computer printouts and other documents — scattered about the floor.

Two computer terminals have been thrown to the floor. One still shows some coherent display on its screen, and appears relatively intact. The other barely flickers and its keyboard has been torn away and smashed.

On the floor by the open door stands a small briefcase, and scattered about are several weapon powerclips.

The smoke and fumes are the results of Fiona's mercenaries shooting apart the cardlock on the door to the computer archives (room 13). Once the party gets closer to the door they will see that part of it has also been shot away by laser fire. As a result all the powerclips on the floor are completely discharged (there are six). The briefcase contains 500g of Tornadium D-19 and a variable timer/detonator set to 15 minutes delay, although it is not yet activated. The mercenaries intend using this to destroy the computer archives.

The vrusk was a computer technician, working on unofficial overtime. The mercenaries shot him in an automatic reaction to meeting someone unexpected. If anyone searches his body they will find a security pass card which will open any door except those to the security office (room 3) and the site manager's office (room 10).

The broken computer terminal is useless. The other terminal is faulty because of the mistreatment it has suffered, resulting in a 10% penalty to the chances of anyone using Computer skill on it.

If the party makes an excessive amount of noise in this room, the two mercenaries in the computer archives will hear and come to investigate. A firefight will then ensue, and Fiona and the remaining mercenaries in the computer room will hear and investigate. The Referee may care to remember that there are 500g of high explosives in the firing zone, and any badly missed shots may hit, and set off, said explosives.

If the party is quiet it will hear sounds of small scale destruction coming from the open doorway. The mercenaries in the computer archives are engaged in destroying the room's contents.

**12. The Computer Room**

Once the door is open the party will be able to see into the room. If they have already fought Fiona and the mercenaries in the computer office (room 11) the door will be left open. If the party does not use a security card to open the door, and forces it open in some other manner, Fiona and her men will be alerted and ready for trouble. Otherwise:

This is obviously the main computer. Four large brown, orange and cream cabinets stand in the centre of the room on a low plinth, and a hardcopy printer stands against the far wall.

Cables are strewn across the floor, and four people are working on these.

As the door slides fully open, one of the people — a young man — turns around and asks 'Have you finished yet?'. His eyes widen and his hand drops towards his gun....

The man who has spotted the party is mercenary No.4 (see the relevant boxed section for details). The Referee should have this NPC make an Intuition check as defined in the Surprise section on p21 of

the Expanded rules. If he is not surprised he will shout a warning to his colleagues — Fiona Talenc and mercenaries 5 and 6 — and then attack.

Once combat starts the mercenaries will fight to the best of their abilities. The Referee should decide what laser setting mercenary 4 will use, but the other two, armed with automatic pistols, will fire bursts. Fiona Talenc will seek cover behind the computer.

If the fight goes against the mercenaries (eg two or more are badly wounded) they will offer to surrender. Fiona will also offer to surrender, but will use her laser derringer at the first opportunity and attempt to escape.

If the mercenaries (2 and 3) in the computer archives (room 13) have not been dealt with in some way they will hear the firing and come to the aid of their employer. The Referee should decide whether they are capable of surprising the party.

The wiring that the mercenaries were installing was a set of explosive charges massing 2kg. The charges have not yet been fully wired up, but if one of the party (with Demolitions skill) attempts to complete the installation he or she will receive a bonus of +15% to the chance of success. The two variable timer/detonators which are wired up are set to 15 minutes and 30 minutes, but not yet activated. Although the computer will only take 300 points of damage before destruction, the explosives in place will cause 5d10 +975 points of damage.

If the full charge is used most of the building will be destroyed. If the security guards are still locked in the toilets (room 7) they will be killed in the explosion. The blast radius will be 20 metres, and the referee should decide on the size of the fallout zone for debris.

Once the charges are successfully set in here, and assuming that the full amounts of D-19 are used the mission has been successfully completed. The computer archives (room 13) will be destroyed because they are within the blast radius. If the party have already fought the mercenaries in the computer office there will be no more in here. The demolition wiring will be intact but incomplete.

If any characters search the computer room they will find little other than the mercenaries' equipment. The only other things in the room are discarded printouts from the hardcopy machine and a stuffed toy in the shape of a green, felt dragon.

### 13. The Computer Archives

The cardlock and door to this room have been shot away by laser fire. If the party have not already encountered mercenaries 2 and 3 in the computer office (room 11) they will be in here.

Two men are busily pulling computer printouts and data storage modules from the shelves where they are normally housed. They are throwing the data modules to the floor and stamping on them. The computer printouts are being scattered in a random fashion. Neither man has noticed you.

These two mercenaries (Nos 2 and 3) will fight with confidence if given the opportunity, knowing that reinforcements are in the computer room (room 12). If firing does break out, Fiona Talenc and the other mercenaries will investigate and attack the party from behind.

If these mercenaries have already been encountered in the computer office the room will be disorganised, and most of its contents scattered and destroyed.

The computer printouts are still readable, though several have large bootprints on

them. The contents relate to maintenance schedules, short reports on APF company finances and listings of all the programs on the computer. If the party takes these listings, the Referee should decide if they are saleable. The value of the listings is 15% of the cost given for computer programs in the Expanded rules.

The computer data modules in the room have been destroyed to a large extent. There were 57, and each of these has a 5% chance of surviving its mistreatment intact. In no circumstances will more than four modules be intact. Although there is no way of determining the information contents of a particular module, the Referee should decide whether these modules, and their contents, are saleable to an APF competitor (eg Sunpower Inc). The Referee should also determine their value — and what Kejganokh's reaction is to the theft of potentially valuable information.

If the party decide to plant separate explosive charges in here, anyone with Demolitions skill will require only 100g of Tornadium D-19 to destroy the contents of the room. As noted in the description of the computer room, the archives and contents will be destroyed by a large explosion in there.

### III. And Finally....

Back at Triad Low Starport the party will find the cybot waiting for them with the remainder of their fee. The cybot will also give each of them a journey class ticket to Gran Quivera in Prenglar. The starship that they are valid for leaves the next morning.

### Experience Points

Once the adventure is complete the Referee should award the characters experience points. Those who used their abilities and skills with imagination and foresight should receive four experience points. Those who played constructively should receive three experience points. Characters whose performance was only average should receive two experience points. Those who merely 'went along for the ride' should receive only one point.

### CREDITS

Design and Text: John Tantoblin  
 Cartography: Paul Ruiz  
 Artwork: Simon Senior  
 The Dralasite in the Dirty Bucket: Graeme Morris

Portions of this mini-module were used at GamesDay '82 and Northern Games Day '83. Thanks to all those who participated (even Ian Marsh!).

Pre-Generated Characters							
Name	STR/STA	DEX/RS	INT/LOG	PER/LDR	IM	RW	M
Princod D	55/50	40/40	50/40	40/50	4	30	20
Skills: Beam Weapons 1, Medical 2, Psycho-social 1							
Farlih V	60/50	45/55	55/55	50/45	6	43	33
Skills: Projectile Weapons 2, Melee Weapons 1, Computer 1							
L N Glascock	50/60	55/65	35/25	40/40	7	38	48
Skills: Gyrojet Weapons 1, Melee Weapons 2, Technician 1							
Dovercourt	45/45	45/55	45/45	50/50	6	33	23
Skills: Projectile Weapons 1, Demolitions 2, Technician 1							
Notes: D = Dralasite, V = Vrusk							
The following characters are provided for use with the module. The Referee may give these to the players or use them for comparison purposes with any characters the players may wish to use.				Each character owns a Civilian Skeinsuit (Princod has a fully charged Inertia Screen). L N Glascock owns a vibroknife with 2 SEU in the powerclip. All the characters have Cr.10 — Cr.20 in change.			

# The East Indiaman Class Freighter

## The East Indiaman Class Medium Freighter

The East Indiaman Class is based on a size 10 hull. It has a beam of 39m and an overall length (including the drives) of 210m. The ship's only defensive system — a reflective hull — is provided as standard, as is a laser battery mounted in a chin turret.

East Indiamen are usually powered by three type B ion engines — these are usually de-rated military drives, or occasionally UPF-surplus drives. Launched from the airdock of Tallyman Associates (the designers) at Triad starport, a basic East Indiaman as described below costs Cr1,330,000. If built by a licensed contractor at another Class I starport the cost of the basic ship rises to Cr1,570,000.

Atomic drives can be fitted in place of the ion engines. This version, including an uprated Drive program and deluxe astrogation package costs Cr2.4 million. The ship's ADF is 3 with atomic drives. All other statistics remain the same.

The deck plans, side view and description below are for a typical cargo carrying East Indiaman. As such, the ship serves as an excellent example of what is delivered to a customer by Tallyman Associates. Naturally, customers and crews rapidly alter and add to the basic specifications to make a ship more like home.

Construction standards: The hull is made of polycarbon and is capable of sustaining 200+2d100 points of structural damage at any point (portholes are made of armoured plastic, and can take the same damage). Airlock hatches can take 200+d100 points of structural damage. Internally, breaching the bulkheads requires 50+2d10 points of damage. Unless noted otherwise, compartment doors are of heavy construction (cf **Structural Points** table; **Alpha Dawn Expanded Rule Book** p25).

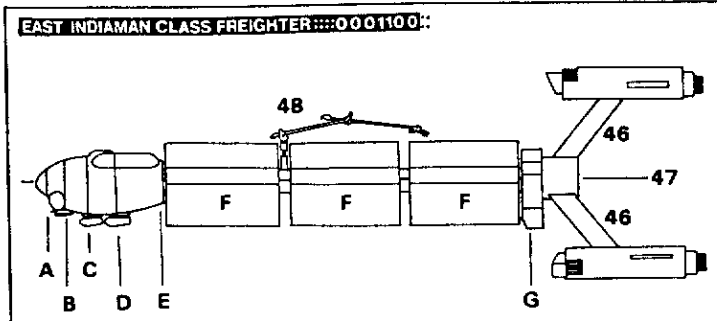

**Security Systems:** The hull is fitted with skin sensors that are tied into the Installation (Ship) Security program. A full size camera system giving coverage of the entire ship is also fitted. The resulting TV pictures may be displayed by any computer terminal on the ship. The Ship Security program also controls movement through a system of cardlocks.

Crew ID cards will open all airlock hatches and doors on the vessel, and allow use of the elevator. Access to the cabins and the Bridge is usually restricted to nominated crew members. When issued, passenger ID cards allow access to the passenger's cabin, the mess and the recreation lounge. The elevator cardlock will only allow access to decks where the user's ID card can open doors.

Although not mentioned in any Tallyman sales literature, there is an additional security system fitted. Built into both of the Life Support systems are tranquilizer devices that can be triggered from the Pilot's position on either Bridge. Anyone who is not wearing some form of protection — a space suit, an emergency suit or a gas mask — is treated as being in the burst radius of a dozen grenades when either of these systems is activated. Usually only the ship's master, pilot and engineer are told of the existence of this system.

**Elevator:** The central lift shaft is built to the same standards as the outer hull. It carries not only the personnel elevator that runs the entire length of the ship, but much of the vessel's 'central nervous system' as well. All the fibre optic computer and intercom links and the main power and water supplies are buried within the walls of the shaft. A recessed ladder is also built into the side of the shaft for use in emergencies when the lift fails.

**Cabins:** All the cabins aboard an East Indiaman Freighter are similar in the fixtures and fittings provided. Each contains a bed locker or closet for each occupant, an intercom, a computer terminal (allowing access to the entertainment functions of the Communications program only), spacesuit storage facilities and an emergency suit for each occupant (see the section **New Equipment** section for further details of the emergency suit).

**Crew:** The minimum recommended number of crewbeings required to run an East Indiaman is four — ship's master, pilot, astrogator, and engineer. Crew members would be expected to do more than one job. A more usual complement is seven — the exact breakdown of tasks varies from ship to ship — as this is large enough to allow some crew back up and small enough to be economic.

The ship's master is a designated crew member, often the pilot or the ship's owner, charged with overall management of the ship. The designated ship's master is granted a large number of user privileges on the computer — he or she is usually the only individual who can access any program from any part of the ship. UPF space regulations hold the ship's master responsible for safety and all other activities of the vessel.

## Transposant Ship

Both governments and corporations have found it necessary to displace troublesome elements in the population, and the moving of these 'transposants' proved too expensive by normal commercial means.

A Transposant East Indiaman carries the nine modified cargo pods, each containing 2000 storage berths and the attendant life support equipment. Each ship can carry up to 18,000 transposant beings — political prisoners, commercial dissidents, criminals, enforced colonial volunteers, and corporate labour transportees — to wherever they are required. The UPF also has an ion-drive Transposant East Indiaman — UPFS S'sor — for relocating troops between bases.

## 'A' Deck: The Bridge

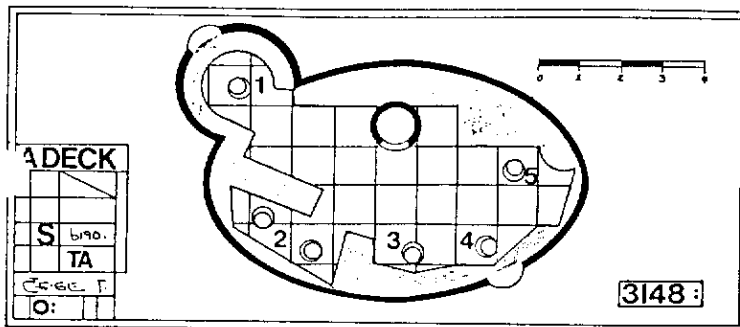

**1. Astrogation:** Only the basic astrogation equipment package is provided on an East Indiaman, as these ships are intended to fly regular, well charted routes. The computer terminal allows access only to the Astrogation, Analysis and Information Storage programs.

**2. Pilot's position:** All ship control functions can be performed from this one seat, as the helm and other controls — including cargo and engine jettison controls — are within easy reach (engine jettison controls are included only if the ship has atomic drives — cargo jettison controls are standard). In addition to the master control panel, the pilot's position allows use of the videocom radio, the intercom system, the hull camera system, the radar and the hull skin sensor readouts.

All programs may normally be accessed.

The adjacent console duplicates some of the controls, allowing a co-pilot to monitor the ship's functions as well. Computer access from this console is restricted to the Drive, Alarm, Damage Control and Communications programs.

**3. Communications position:** Usually unoccupied, this console is the central control for the ship's communication and detection equipment — the videocom radio, the intercom system, the hull camera system, the radar and the hull skin sensors. Only from here can computer data be transmitted (for example, cargo manifests to a customs inspection ship) to an external system through the videocom radio.

**4. Fire Control position:** This is the primary control position for the chin mounted laser battery (10 & 10A) and control of the weapon is normally assigned to this position. A character with Energy Weapons Gunnery skill may use his or her subskills from this console to influence the success of any fire from the laser battery.

**5. Engineer's Monitoring position:** This console allows indirect monitoring of the ship's engineering functions through Drive, Alarm and Damage Control programs. The console also includes a separate intercom link (not connected to the central intercom) to the workpods, the engineering decks (E and G Decks) and the spacesuit radios.

## 'B' Deck: Computer and Avionics

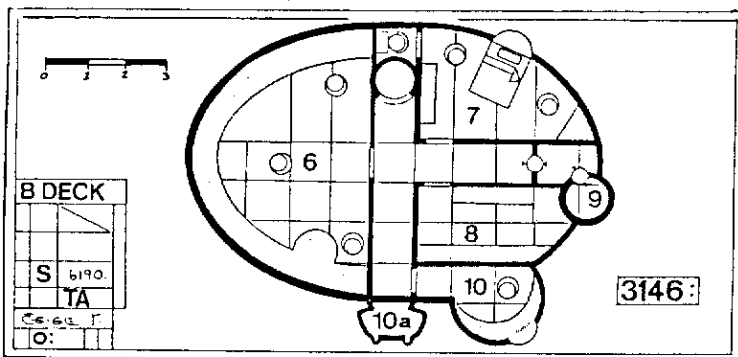

**6. Computer compartment:** This compartment is built to hull standards, and the door is fortified. Only the ship's master, the pilot and the engineer can enter and a security code must be entered at the Pilot's position (2) before the door will open.

The compartment contains the ship's computer, a level 4 machine, and the bulk of the ship's avionics — the electronic, detection and communications equipment. This includes the hull camera control, the radar installation, the astrogation electronics package and the videocom system.

The computer runs all the programs needed on the ship. These include Drive, Computer Lockout, Astrogation, Alarm, Damage Control, Cargo

Handling, Laser Battery, Skin Sensor, Life Support, Installation (Ship) Security-4, Commerce-2, Communications-2, Computer Security-3, Information Storage-3, Bureaucracy-3, and Analysis-4 programs, which are supplied as standard. There is sufficient space to expand the computer to a maximum of 500 function points.

**7. Pilot's Cabin:** The pilot's cabin is deliberately placed within the ship as close as possible to the Bridge. In addition to the usual fixtures, the pilot's cabin has its own toilet facilities and a small automatic galley that can provide hot drinks and quick snacks. The Computer terminal is linked directly to the Drive and Alarm programs and is programmed to alert the off-duty pilot to any major malfunction in the ship's systems.

**8. Arms Locker:** The Arms Locker will only open under the same circumstances as the Computer Compartment (6). When delivered from the airdock, the arms locker is not usually supplied with weaponry, but a small weapons workbench is fitted.

**9. Escape Pod:** The ship's one escape pod is intended for the pilot's use. In an emergency, the pilot is expected to remain at the control console until the last possible moment and then escape aboard this pod.

**10 & 10A. Secondary Fire Control, Laser Battery and Radar Mounting:** All the functions of the Fire Control position (4) on the bridge are duplicated here, with the added thrill of being able to watch the laser battery in action.

Major repairs to the laser battery or radar mounting (10A) can only be made from outside the ship, but some minor circuitry can be reached from inside. If the laser battery or radar system is damaged in combat, there is a 15% chance that a repair can be made from within the ship.

## 'C' Deck: Forward Crew Quarters

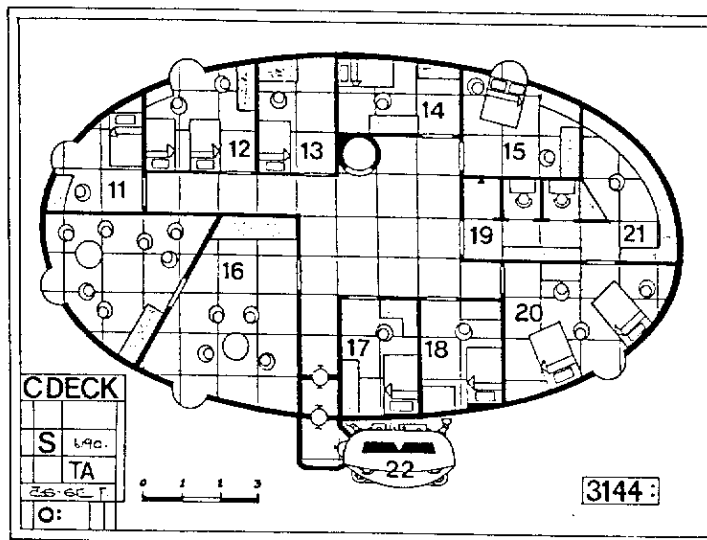

**11-15. Cabins:** Two of the cabins are for double occupancy, one (12) has two single berths, while the other (15) has a double bed installed.

**16. Recreation Lounge:** The recreation area has a large screen computer terminal linked to the entertainment section of the Communications program. A small automatic galley, capable of providing drinks and snacks, is also fitted. In emergencies, this area can be converted into adequate — if somewhat uncomfortable — passenger space.

**17 & 18. Guard Cabins:** Cargo guards, provided by the cargo owner(s) to prevent the ship and cargo being 'lost', are allocated special cabins. These differ from normal cabins in that the doors are fortified, a weapon power clip/pack recharging station is provided and the computer terminal is allowed access to Analysis, Information Storage, Commerce, and Installation Security programs.

**19. Toilets and Shower:** The toilets and shower are standard space-going models, designed for use in zero gravity conditions.

**20 & 21. Sick Bay & Dispensary allocation:** These two compartments are intended for use as a sick bay and medical office. An augmented (with a complete set of spare drugs) medkit is included when the ship is launched, along with two beds and a computer terminal.

**22. Lifeboat:** The lifeboat is a standard model (see *Knight Hawks Campaign Book* p17), streamlined for planetary landings, and it has a primitive autopilot.

## 'D' Deck: Aft Crew Quarters

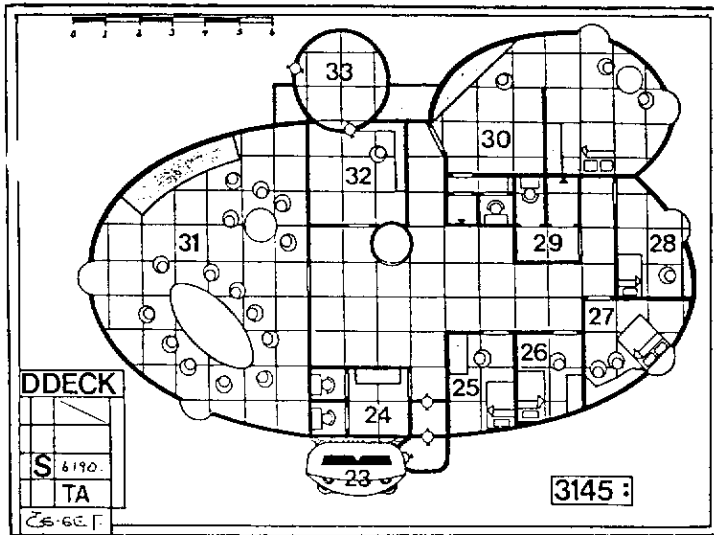

**23. Lifeboat:** Identical to the lifeboat on 'C' Deck (22).

**24. Toilets:** The toilet is designed for use in zero gravity conditions as well as in the artificial gravity of ship acceleration or deceleration.

**25 & 26. Guard Cabins:** Identical in all major respects to guard cabins 16 & 17 ('C' Deck).

**27 & 28. Cabins:** One of these cabins (27) is equipped for double occupancy with a double bed, while the other has a single berth.

**29. Toilet and Shower:** The toilet and shower are standard space-going models, identical to those on 'C' Deck (19).

**30. Owner's or Master's Cabin:** This is the most comfortably appointed cabin on the entire ship, and is usually decorated to suit the owner's taste. The cabin has its own shower and toilet facilities, is fitted with a g-size bed, and has an automatic galley that serves any meal within its programming (the programming can be varied to suit the user's requirements). When not in use by the owner or ship's master, this cabin can be used as first class passenger accommodation.

**31. Crew Mess Area:** The mess area has the largest galley on board the ship, capable of providing any good quality standard food — or at least a reasonable imitation. The computer terminal in here is, unless there are passengers aboard, always linked to the Alarm and Installation Security programs and set to alert any crew members should an emergency occur.

**32. Forward Airlock Compartment:** In addition to a simple manual control panel for the airlock, this compartment also contains a dozen spacesuit lockers. A rack for storing rocket packs is fitted, along with a shower unit for cleaning suits of any contaminating material.

**33. Forward Airlock:** The forward airlock is used for passenger and crew transfers — whether in a station dock or between ships in flight.

**34. Secondary (Emergency) Bridge:** The door to this compartment is fortified, and the cardlock will only open for the ship's master, the pilot or the engineer. All the functions of the Bridge (A Deck) are duplicated, but to prevent the ship being hi-jacked, the computer will only accept commands from here if those commands have been authorised by the ship's master or the pilot. However, the computer's Installation Security program will automatically accept the secondary bridge as a valid control centre if 'A' Deck is no longer functional (eg if the Damage Control Program reports that the hull has been breached, or the Life Support program reports that the Bridge is in vacuum).

**35. Middle Airlock:** This hatchway is usually used for the loading of passenger luggage and small items of cargo that must be carried in a pressurized environment. Unless the ship's master has authorised the transfer of luggage with the Installation Security program, this airlock will be locked — and crew ID cards will not activate the cardlock.

**36. Forward Utility Access:** The power, water and air supply for the forward decks of the ship can all be serviced in this compartment. The majority of the compartment is taken up with the circuitry for these functions, and — most importantly of all — the back-up life support unit (also see **Security Systems**).

This unit is not controlled directly by the ship's main computer, but has its own dedicated processor (a small level 1 computer running only a Life Support program). The back-up LSU is normally used only in emergencies, but with both life support units running an East Indiaman can carry a maximum of 70 beings, including the crew. Conditions in this situation would not be pleasant, but everybody would survive.

**37. Cargo Arm Control:** The computer terminal at this location is modified to include a joystick controller for the cargo loading arm (48) and release controls for the cargo pods — either 'soft' release, or to jettison the cargo. The terminal also has automatic access to the computer's Commerce program. The compartment is only used when cargo is being moved while the ship is docked, or as a security station because of the view of the outer hull that it commands.

**38. Luggage Space:** This is simply a pressurized hold for any luggage or delicate cargoes. It is normally kept locked during flights.

## 'F Deck': The Cargo Hold

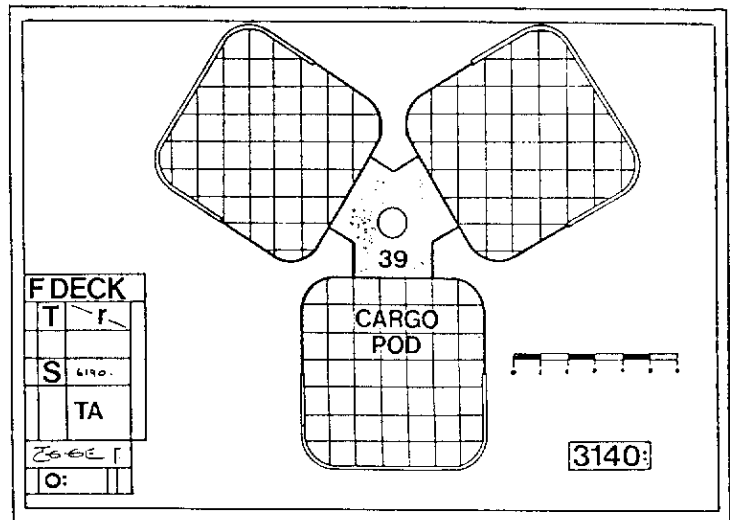

**39. Cargo Decks:** The nine cargo bays or pods on board an East Indiaman are all 14 metres square and 50 metres high and are arranged in groups of three around the central 'spine' of the ship - giving three 'cargo decks'. The entire outer half of the cargo pod can be swung open to facilitate loading and unloading and, as a result, the standard cargo pods are not pressurized.

The cargo pods have no connection (other than simple monitoring devices) with the interior of the ship, and are detachable — in emergencies they can be jettisoned from the pilot's position (2) on the bridge or Cargo Arm Control (37). This makes East Indiamen ideal for carrying high risk dangerous loads. Jettisoning pods takes 10 turns (one minute), and the jettisoning ship must change course after doing so to distance itself from the cargo pods.

Many of the larger corporations that own East Indiamen do not bother to unload individual pods from ships that are on regular scheduled flights — the entire pod is simply removed and replaced by a cargo pod containing the manifest for the ship's next destination. This minimizes the amount of time that a ship must spend in dock, as replacing a pod takes two hours. Pods that are part of the same group of three in a deck may not be worked on simultaneously.

## 'E' Deck: Forward Engineering Deck

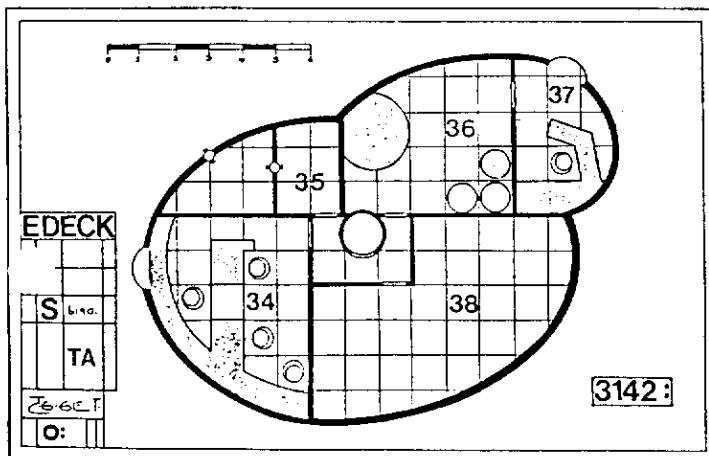

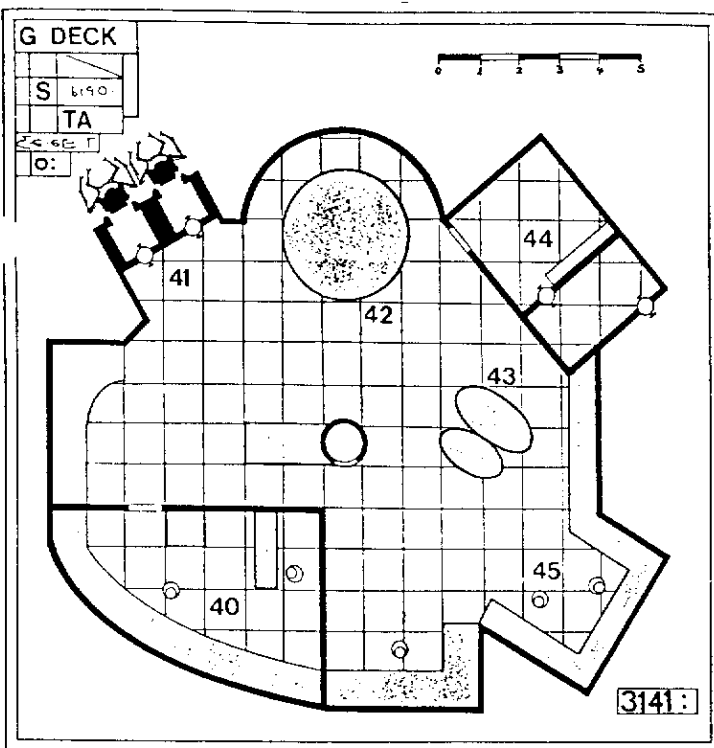

**40. Workshop:** The workshop contains sufficient tools to carry out most running repairs to the ship — the equivalent of a robcomkit, a techkit and an engineer's toolbox — although no insuit is provided. A laser powertorch — and a bench mounting to turn it into a drill or lathe cutter is also included in the standard workshop fittings, as is a power backpack. Normally the laser powertorch is plugged directly into the ship's power supply when used in here.

**41. Workpods:** Two workpods (see the *Knight Hawks Campaign Book* p30) are fitted as standard. Whenever a workpod is used and then repositioned in its launch cradle, diagnostic checks will be carried out by the ship's computer and the pod will be refueled if this is required. Any repairs that are must be carried out on the pod will be displayed on the engineer's monitoring terminal on the Bridge (5) or here on G Deck (45).

**42. Main Life Support Unit:** This unit is run by the computer and is the one that is normally in operation. This one unit can supply the air, food and water requirements of up to 35 beings, although conditions would be somewhat crowded.

**43. Computer Parabatteries:** These are a final emergency backup system (one type 4 and one type 3 parabattery) to enable the computer to function — in a severely impaired way — even if the main parabatteries of the ship are exhausted. If this system becomes the only power source for the computer it will suspend all the programs except for the Life Support and Communications programs.

**44. Aft Airlock:** The airlock has a simple manual control panel. A rack for storing rocket packs is fitted, along with a shower unit for suit cleaning. Three rocket packs plus refills are provided by the ship's builders. On ships with atomic drives two engineering insuits are also provided.

**45. Engineering Monitoring:** This console monitors all of the engineering functions of the ship through the Drive, Alarm and Damage Control programs. The serviceability of other ship systems — such as the computer, workpods, camera system and the like — is also displayed here. The console also includes a separate intercom link (not connected to the ship's central intercom) to the workpods, the forward engineering deck, the engineer's monitoring position (5) on the Bridge and the spacesuit radios.

## External Hull Features

**46. Drive Access:** The drive access tunnels are built into the engine struts and allow superficial inspection of the engine components and fuel tanks. Major repairs have to be made from outside the ship. Aboard some ships the 'keel' engine strut has been modified to include a cubic metre of storage space, suitable for smuggling small, very high value illicit cargoes.

**47. Main Parabatteries:** The main parabatteries provide all the ship's power when the drives are off and the ship is not connected to an external power source (in an airlock for example). These batteries are the equivalent 15 type 4 parabatteries (a total power store of 60,000 SEU) and are automatically recharged when the drives are operational.

Because of their placement within the ship, the parabatteries have an additional use as stern armour. When an East Indiaman is fired on from directly astern, the first 15 points of hull damage may be taken as hits upon the batteries. The equivalent power storage capability of one type 4 parabattery is lost for each point of hull damage taken in this fashion.

**48. Cargo Loading Arm:** The cargo loading arm is installed on a 35 metre diameter circular track that runs around the spine of the ship between the first and second set of cargo bays. From here, the cargo arm can be extended to reach into any of the cargo pods — taking ten hours to load or unload the entire hold — or it can assist in releasing a pod, reducing the time needed to do this to one hour.

## REFEREE'S Notes

In *Knight Hawks* game terms all standard East Indiamen have the following statistics:

### Standard East Indiaman (Freighter)

Hull Points:	50
Weaponry:	Laser Battery
Defences:	Reflective Hull
Damage Control Rating (DCR)	50
Acceleration/Deceleration Factor (ADF)	1
Manoeuvre Rating (MR)	3

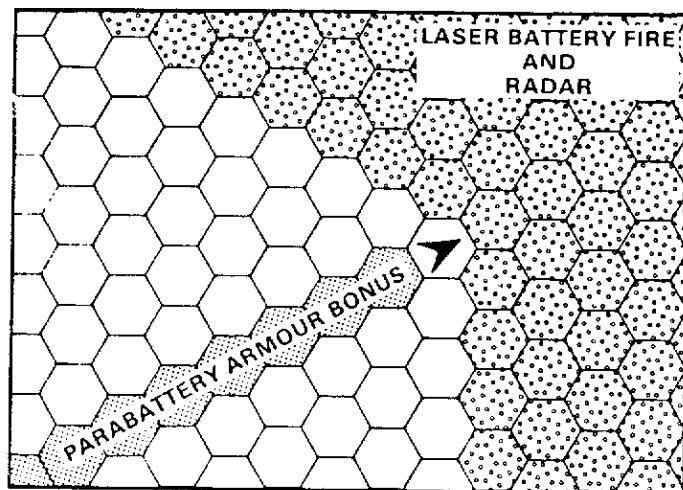

### Design Faults on the East Indiaman Class

There are a number of design faults in the East Indiaman class that characters should not find out about, except through bitter experience. The escape pod (9) is too far away from the Bridge to be reached in a convenient time. If anyone attempts to escape from the Bridge by this route in an emergency (see *Escaping from Destroyed Ships, Knight Hawks Campaign Book* p37) the referee should secretly roll 2d10. This is the extra time in six-second turns that it takes the elevator to reach the bridge and then bring the character back down to 'B' Deck.

The chin mounted laser battery (10A) is so placed that it is incapable of firing on a target that is 'above' the ship or behind it. In terms of the *Knight Hawks* boardgame, this means that the laser battery is restricted to firing at targets within the shaded area of the diagram. Because it is mounted in the same place, the radar system can only 'see' objects that fall within the same zone.

# A> ON THE ROCKS

## A> BY MIKE BRUNTON

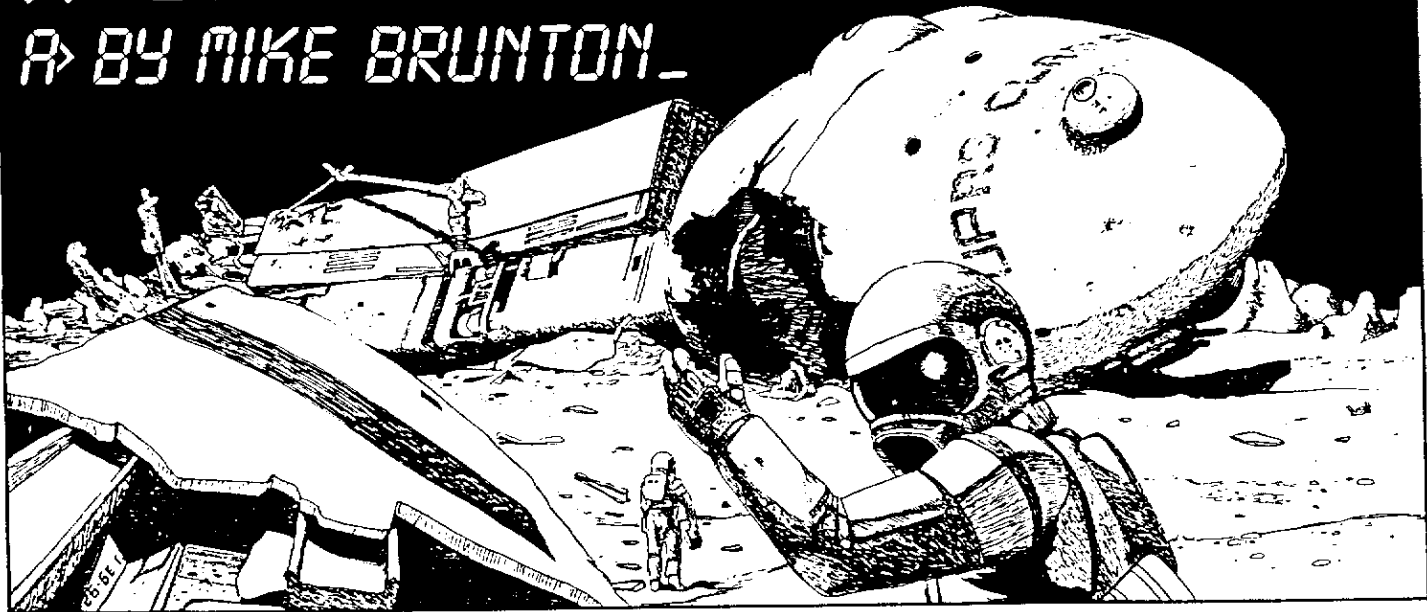

### INTRODUCTION

**On the Rocks** is an adventure for the **STAR FRONTIERS®** game, and the referee will need copies of the **Alpha Dawn** and **Knight Hawks** rules to run it. The referee should also be familiar with the East Indiaman Class Freighter on p27-30 of this issue of **IMAGINE™** magazine.

If you intend running a character in this adventure, please stop reading here.

The mini-module is designed for groups of 3-5 player characters, who will need a good variety of skills from the Alpha Dawn rules. They will find it difficult to succeed without Technician, Computer and Military skills. Spaceship skills could prove useful, but are not essential to success — unless the players are very careless of the lives of Non-Player Characters (NPCs) during the course of the adventure.

### Background

The East Indiaman UPRS (UP Registered Ship) Clan Chattan spent the last three years on the fairly profitable, but undramatic, Truane-Dixon's Star haulage run. The cargoes never made vast profits, but the bank payments and crew wages were always paid on time. One month ago, the last voyage of the Clan Chattan began as had all the others, with Jasmine Cumae, the owner, ship's master and pilot, filing her flight plans at the Pale, Truane starport control. The Clan Chattan accelerated away from Truane and jumped into the Void. The ship did not arrive at Laco, Dixon's Star. The Clan Chattan had been late in the past, so nobody worried. However, after a week without any evidence of the ship's fate, the Laco Development Corporation (LDC), as the owners of the ship's cargo, declared the Clan Chattan missing, blaming pirate action and/or the crew of the Clan Chattan for the loss.

Two days later, the robot prospector ship Romero-4 quietly made its first rendezvous with the asteroid Plutarch, Dixon's Star. Plutarch's orbit had changed slightly, and Romero-4 found the cause — the Clan Chattan, by a billion-to-one chance, had collided with the asteroid. Maintaining radio silence for commercial security reasons, Romero-4 completed its survey, and then turned for home.

Auric Mining & Construction (AuriCon), the owners of Romero-4, did not want the crash of the Clan Chattan to become public knowledge. Ownership of Plutarch was at stake. Under UPF law, anyone who had survived the crash (however briefly) could claim ownership, and Plutarch was important to the company — millions of tonnes of orbital construction material in a star system without an asteroid belt. Within days, a company police scout was diverted to Plutarch and landed a small team of Regulators to establish the company's mining rights.

The Clan Chattan's fate did not stay a secret for long. By chance, Nathaniel Cumae — Jasmine's half cousin — worked for AuriCon and saw the Plutarch scanning reports. Risking his future (and his life), he anonymously sent copies to the LDC factor at Pale, Truane. The Clan Chattan and its cargo had been found. Recovery was another matter...

One week ago, another East Indiaman, the **Paltsa Ryby**, arrived at Pale, Truane. The LDC factor immediately approached the ship's master, Captain Glaz Ptitsy (a Vrusk), and offered him Cr30,000 and 5% of the cargo's value for its recovery, but only if this was done quickly. Glaz Ptitsy accepted on the spot, despite the fact that the crew of the **Paltsa Ryby** consisted of two people: himself and Milo Hansen — his engineer and co-owner.

### Starting the Adventure

Glaz Ptitsy (see **The Paltsa Ryby** for more details) needs a salvage crew. He will advertise for crew members through the starport databank — and actively seek employees in the various bars and spacer flophouses on the starport space station. Unfortunately for him, AuriCon know what he has been hired to do, and the company has persuaded potential crewbeings to take up other offers of employment.

By the time Glaz Ptitsy approaches the adventurers, they should have heard of him — and his lack of success in hiring people. He will offer the group standard rates, depending upon their skill levels. If necessary he will add a further clause to the contract: 1% of the value of any salvaged cargo, to be divided amongst the group. This is a potentially vast sum, but he is now desperate — time is running out.

### The Paltsa Ryby

The **Paltsa Ryby** is a rather battered, standard ion-driven East Indiaman — see the class description for further details. It carries sufficient armour, space suits, rocket packs and fuel to outfit the adventurers for work on Plutarch. The arms locker contains ten laser pistols, five laser rifles, a single heavy laser that needs repairing (Milo Hansen has never found the time), and a single dozen grenade. The arms locker is also well stocked with power packs and clips.

The **Paltsa Ryby** has only two permanent crew: Captain Glaz Ptitsy, who owns 70% of the vessel, and co-owner and engineer, Milo Hansen. The two are good friends — despite the fact that they argue all the time.

#### Paltsa Ryby Crew

Name	STR/STA	DEX/RS	INT/LOG	PER/LDR	IM	RW*	M*	Comp
Glaz	50/60	40/60	75/50	50/70	6	80	25	30
	Skills: Technician 6, Computer 6, Beam Weapons 6, Pilot 3, Astrogation 3, Gunnery (Energy Weapons) 2 (Vrusk Male)							
Milo	65/90	20/15	50/75	10/05	2	30	43	
	Skills: Technician 5, Robotics 4, Engineering 6, Beam Weapons 2, Melee Weapons 1. (Human Male)							

\* RW — The chance to hit with best Ranged Weapon.  
\* M — The chance to hit with best melee weapon

Captain Glaz Ptitsy is a competent business being — he will offer the adventurers the minimum wages he thinks he can get away with. On the other hand, he will not abandon them should a situation deteriorate. Glaz takes care of Milo, keeping him out of jail and as sober as possible — and will not hear a word said against him.

Glaz knows that AuriCon has an interest in Plutarch, and understands the UPF space law on ownership. He also has a cargo manifest for the Clan Chattan in his possession. In addition to the surviving cargo listed below, the Clan Chattan was also carrying computers (valued at Cr120,000) and a second transposant pod with 2000 occupied storage class berths (indentured labour valued at Cr7 million). The cargo manifest does not give the surviving cargo, only what was carried when the Clan Chattan left Pale, Truane.

Milo Hansen crawled inside a whiskey bottle years ago — and never came out. His low intellectual and social abilities reflect this, while his melee weapons skill is based solely on his proficiency with broken bottles and chair legs. Drunk or sober, Milo is fully capable of carrying out his duties, and he is devoted to Glaz, his only real friend.

## GENERAL COURSE OF PLAY

### Pale Station, Truane & the Flight to Plutarch

Once the adventurers have agreed to work for Glaz Ptitsy, he will give them two hours to finish any other business they have, collect their possessions, and report to the Paltsa Ryby in the station docks. AuriCon will learn of Glaz Ptitsy's doings through one of their agents in the Port Authority and will send a team of Regulators to intercept the adventurers.

The Regulators — identical statistics to those on Plutarch — will ambush the adventurers in one of the commercial zones attached to the docks. The referee should use the Commercial Deck Section of the station floor plans provided in the Knight Hawks game to represent this area. The Regulators, equipped with needler pistols, stunsticks and military skeinsuits, will be waiting in the Spacer Club for the adventurers to appear, and will attempt to capture them. If they succeed in doing so, the characters will wake up as part of the indentured labour force of AuriCon. The course of play from this point is up to the referee.

To avoid this, the adventurers need to reach the elevator, which will take them to the Paltsa Ryby's dock. Any NPCs on the station who witness the fight — Port Authority personnel, off-duty spacers, etc (the referee should feel free to invent bystanders) — will not interfere in what appears to be a commercial vendetta.

Once on board the Paltsa Ryby, the adventurers will be introduced to Milo Hansen. The ship will leave the dock, and head for Dixon's Star. The flight to Plutarch will take five days, during which time the referee should feel free to invent events of interest. The adventurers will be given crew status as far as the ship's security systems are concerned.

### Plutarch

Plutarch is an interstellar rogue caught in the gravity well of Dixon's Star. Deep black in colour, it is made up mostly of carbon, nitrogen and hydrogen compounds with small amounts of water ice and nickel-iron ore. Plutarch is potentially very valuable, containing many of the raw materials needed to build and maintain starships and space stations. From Plutarch's constituents, plastics can be synthesized, hydrogen for fuel and oxygen for air can be extracted; the water is valuable in itself, and the metal content is simply a bonus. While Plutarch is quite large when compared to a ship — a roughly oblong boulder some 2.5km long, 1km wide and 500m deep — its mass is very low. For game purposes assume that the gravitational pull of Plutarch is minimal, ie zero gravity conditions. The referee should note the effect that this will have during the game — eg objects (and people) will tend to float away unless tethered.

The crash site of the Clan Chattan stands out as a streak of silver-white debris against the deep black of the rest of Plutarch — a colour due to the gradual accumulation of aeons of interstellar dust.

### The AuriCon Regulators

The Auric Mining & Construction Police, known as 'Regulators', are in charge of security throughout AuriCon's business empire. They also fight the company's wars. Landed on Plutarch to establish ownership, the Regulator detachment has orders to allow no-one else to land, no matter what the reason. If necessary, they will use force.

When the Paltsa Ryby arrives at Plutarch, the Regulators will make contact and tell Glaz Ptitsy to move away immediately 'or face the consequences....' However, Brett will exceed his authority and allow a landing if — and only if — Glaz Ptitsy and the adventurers agree that they have no claim to Plutarch whatsoever. Under these conditions a supervised landing will be allowed, but no help will be offered.

Brett can be bribed if offered a sum of Cr250 or more. He will allow the spare generator to be used to supply power for repairs to the Clan Chattan. He will not allow the generator to be used if he has been threatened or if any of his men have been harmed.

In point of fact, AuriCon have no right to Plutarch — it belongs to the late Jasmine Cumae. If her body is found (see **Repairs**), and Brett gets to hear of it, he will order the Paltsa Ryby to leave at once. He and his men will remove all traces of Jasmine's presence after the crash, up to, and including, setting explosive charges on the wreckage of the Clan Chattan.

#### The Regulators (All Human)

Name	STR/STA	DEX/RS	INT/LOG	PER/LDR	IM	RW	M
Brett	50/60	45/45	40/50	30/45	5	53	35
Reg.1-6	60/70	50/45	25/30	15/10	5	45	60

#### Skills:

Brett: Beam Weapons 3, Melee Weapons 1, Computer 1.  
 Regulators: Projectile or Beam Weapons 2, Melee Weapons 3, Medical 1 (Regulator 1 only), Demolitions 1, Technician 2 (Regulator 2 only)

The Regulators are all equipped with space suits, space suit armour, military skeinsuits, albedo screens and rocket packs. Brett is armed with a laser pistol (connected to a 50 SEU power backpack). His squad is armed with two shotguns (see **New Equipment**), 5 laser rifles and vibroknives.

The Regulators are housed in a survival unit — basically three linked plastic domes with an airlock. The plastic is capable of taking 30 points of structural damage. The entire unit is capable of providing life support for up to 12 people for a period of 1 week, and is equipped with a simple videocom, an entertainment computer, a weapons and spacesuit storage/maintenance area, an automatic galley, and bunks for the occupants. The unit is powered by a type 2 generator (this particular unit has a spare). The Regulators have supplies for two months, as well as 100 rounds of shotgun ammunition and 2kg of Tornadium D-19. Re-charges for the laser weapons are effectively unlimited.

## New Equipment

**Shotguns:** These weapons are often included in spaceship arms lockers — their effects on spacesuits can be dramatic.

#### Shotgun

##### Projectile Weapons

	Damage	Rate	Defence	PB	Short	Med	Long
Shotgun	8/3/2/1§	1	Inertia	0-2	3-8	9-18	19-40
Sawn-off	8/2§	1	Inertia	0-2	3-4	—	—

§ Damage in d10s — the decrease occurs at each range, and is applied to all the targets within the spread of shot (2m wide at point blank and short range, 4m wide at medium and long range). A shotgun blast only causes 3 points of structural damage, but they are very dangerous weapons to use against spacesuits. A shotgun blast will cause 1d10 2cm holes in a spacesuit, each of which has a 60% chance of self-sealing. Spacesuit armour has a 55% protection rating against a shotgun blast (see **Knight Hawks Campaign Book** p28).

A standard shotgun has a mass of 4kg, costs Cr450 and takes a 5 shot clip costing Cr15. Sawn-off shotguns have a mass of 3kg (the barrel is much shorter), cost Cr600, and are either single shot models or take a three round clip (Cr10).

When a character uses a shotgun in zero gravity, he or she should make a Dexterity ability check. Failure indicates that the character has been thrown off balance by the recoil, and must spend the next turn recovering or suffer a -50 penalty on the chance of hitting a target.

**Emergency suits:** These are little more than person-shaped airtight plastic bags with an cartridge that provides 10 minutes of air. An emergency suit has no value as armour, nor is it self-sealing. It can, however, be put on in 3 turns (a vrusk emergency suit takes 4 turns to put on), and a normal spacesuit may be worn on top.

Emergency suits cost Cr400 and replacement air cartridges cost Cr25. Both are freely available at all starports. Being a predominantly human company, Tallyman Associates provide a free human emergency suit for each cabin on any new ship launched from their airdocks.

## The UPRS Clan Chattan

The Clan Chattan collided with Plutarch after leaving the Void and was flying stern first with the drives on to decelerate from jump speed. As a result, Plutarch was in the Clan Chattan's radar 'blind spot', and the asteroid wasn't even seen before the collision took place.

Fortunately — although the majority of the crew didn't live to appreciate the fact — the Clan Chattan did not strike Plutarch squarely, but at an angle along the asteroid's longest axis. The damage to the asteroid was minimal — one more impact crater made little difference. Most of the Clan Chattan eventually came to rest against a fracture line caused in a collision with another asteroid centuries earlier. The rest of the ship was spread in a thin layer along the line of the crash.

The diagram shows the position of the various parts of the wreck, and also gives the location of the Regulators' survival unit — the wreckage provides a convenient marker for resupply vessels.

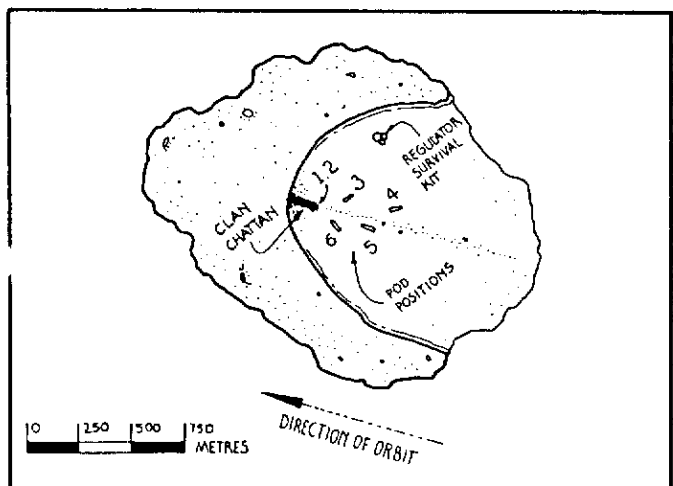

Although the Clan Chattan is no longer spaceworthy, and will never be so again, the ship has not been totally destroyed. The angle of the crash, and the ship's attitude at impact, meant that much of the momentum of the ship was absorbed by the ship's drive nacelles and the parabattery housing. The aft engineering deck and the keel mounted cargo pods also cushioned much of the force of the impact.

The condition of the ship is listed below (the numbers and letters in brackets refer to the East Indiaman deck plans). The referee will find it useful to mark the damaged and destroyed locations on a copy of the plans, and **IMAGINE** magazine grants permission to photocopy the deck plans for this purpose. References to areas on board the Paltsa Ryby will be distinguished by a 'P' prefix, eg P48 the cargo arm.

The recreation lounge (16), the guard cabins (17, 18, 25 & 26), the lifeboats (22 & 23), the toilets (24), the crew mess area (31), the emergency bridge (34), the luggage space (38), the three keel mounted cargo pods (see 39), aft engineering and maintenance ('G' Deck), the drive access tunnels and engine struts (46), parabatteries (47), and the drives, have all been totally destroyed. The ship is simply a mass of wreckage, open to space at these points.

The hull on 'B' deck is severely cracked and warped and will no longer hold an atmosphere, but apart from superficial damage caused by flying debris, the deck is still in one piece. The Bridge ('A' Deck), and escape pod (9) have survived virtually unscathed, although the Astrogation bubble (1) porthole has a crack in it which has let the ship's air out of this deck.

the body of Jasmine Cumae, the ship's master, will be found in the escape pod. Jasmine survived the crash, only to die of suffocation when the pod's life support ran out. The pod was damaged in the crash and could not be launched. Technically, Plutarch is part of Jasmine Cumae's estate.

## The Cargo

The Clan Chattan was carrying a mixed cargo on her last voyage — as might be expected on a ship carrying goods to a frontier colony. Of the six pods that survived the crash, two are still attached to the spine of the ship. The others broke free when the ship crashed, and are scattered along the crash line. All the pod hulls, except one, have cracked.

Glaz Ptitsy's cargo manifest for the Clan Chattan only lists what was on board, not what has survived, so unless the adventurers physically inspect the cargo pods or manage to get the Clan Chattan's computer working (see **Repairs**), they should not be told what is salvageable. For convenience, the surviving cargo pods are designated 1 to 6. Pods 1 & 2 (the port forward and middle cargo pods) are still attached to the Clan Chattan, the others lie in the positions indicated on the diagram. Listed below are the contents of the various pods, their value and other relevant details.

Pod 1. Agricultural Chemicals — granulated fertilizers, pesticides and fungicides — valued at Cr40,000. Recovery will take 45 labour-hours.

Several of the chemical containers have split, spilling their contents into the pod. Anyone who enters the pod will automatically pick up chemical dust on his or her spacesuit. Unless this is washed off under the spacesuit shower in the forward airlock (P32) the Paltsa Ryby will be contaminated by the various pesticides.

This contamination is handled as though it is a -5/2d10 infection. A character with medical skill can use the Diagnosis and Neutralize Toxins subskills as normal — even though these chemicals are rated as an infection rather than a poison. The chemicals will result in a permanent loss of 1d10 of a random ability even when 'cured'.

Pod 2. Transposant Pod — 1800 colonial draftees and commercial dissidents, all indentured labour for LDC — contracts valued at an average of Cr3500, total value Cr6.3 million. Transposant pods are built to withstand a good deal of rough treatment — the cargo is, after all, relatively delicate. The transposants are still alive, making this the most valuable salvage on the wreck.

The pod cannot be unloaded and the storage berths transferred as this would kill the transposants. The entire pod must be released from the wreck and moved to the Paltsa Ryby. (The replaced pod will have to be abandoned on Plutarch — possibly for later collection). Removal of the pod is impossible without the aid of the Clan Chattan's cargo arm (48), and the pod release mechanism has also been damaged. Once the pod release and arm are working (see **Repairs** below), removing the pod and connecting it to the Paltsa Ryby will take at least 4 hours for three people (one person on each cargo arm, and one supervising).

There is a 30% chance (-5% per level of technician skill) that the transposant pod will slip during the transfer, causing 1d10 points of hull damage to the Paltsa Ryby.

Pod 3. Agricultural machinery — robot ploughs, harvesters and fruit pickers — value Cr35,000. This pod has split open on impact and much of the machinery is damaged — only 35% is recoverable (value Cr12,550). Collecting the various items of machinery and loading them into one of the Paltsa Ryby's pods will take 30 labour-hours.

Pod 4. Mixed cargo — luxury goods and foodstuffs, computer parts, jetcopter spares, three crates of UPF SpaceMail parcels, industrial laboratory equipment — total value Cr130,000.

15% of the cargo in this pod has been destroyed, but the most valuable items — the SpaceMail and a case of rare wine — are still intact, although the sediment in the wine has been disturbed. The SpaceMail and wine are valued at Cr30,000 (for insurance purposes) and Cr12,500 respectively. Extracting the parcels and the wine from the wreckage will take 4 labour-hours, while recovering the rest of the cargo will take a further 16 labour-hours.

Pod 5. UPF chartered pod — weapons and other equipment for the Laco militia battalion — value Cr120,000. The entire contents of this pod have survived intact, and can be recovered in 30 labour-hours. The exact contents are left to the referee's discretion, but should include most of the lighter weapons and defensive armour listed in the Alpha Dawn rules.

If the adventurers decide to use any of the weaponry from this pod, it should be remembered that it is all still in its original packing, and none of the power or ammunition clips are charged or loaded. Readyng any of these weapons will take a character with military skill one hour to clean and check the weapon — in addition to the time that must be spent charging or loading clips.

Pod 6. Medical supplies — drugs, surgical consumables and a diagnostic computer — value Cr75,000. The contents of this pod were carefully packed against violent acceleration, and have survived remarkably well. Only 10% of the cargo — mostly drugs — has been damaged beyond salvage. Recovery will take 35 labour-hours.

## Repairs

Major repairs to the Clan Chattan are out of the question, but it is possible to effect some minor repairs to one or two of the ship's systems, in particular the pod release mechanism and the cargo arm (48). However, all the repairs are pointless without a power source. The Clan Chattan's parabatteries are gone, and taking power from the Paltsa Ryby would require the facilities of a dockyard. There is another solution — the Auricon Regulators possess a backup type 2 generator for their survival unit. This is capable of producing enough power for the computer or the cargo arm — but not both at the same time.

Assuming that the Regulators can be persuaded — by whatever means — to part with their generator, repairs can be carried out using the appropriate subskills. A character using the Repairing Computers subskill suffers a -30% penalty, and can roll once per hour for success. Once the computer is repaired, the Displaying Information subskill suffers a -15% penalty. These are the only two subskills that can be used on the Clan Chattan's computer.

A character using the Repairing Machinery subskill to mend the cargo arm (48) and the pod release mechanism suffers a -10% penalty, and a roll for success may only be made every two hours. Once repaired, a dexterity of 60 or more or Technician skill level 2, is required to avoid causing a breakdown (-20% to repair). The use of the Clan Chattan's cargo arm is required to move the transposants (pod 2) and will reduce the time that need be spent unloading pod 1 to six hours work for the arm operator.

## The Wreckers

Sixty hours after the adventurers begin their salvage operation, another ship will arrive at Plutarch. This is the Lizzie Borden — a flying junkyard if there ever was one. The Lizzie Borden has been built from the wreckage of nearly as many space ships as it has parts — it was once a merchant ship, but has, over the years, grown into its current ugly self, absolutely unrecognisable as a definable class of vessel.

The Lizzie Borden has the following statistics:

Lizzie Borden (freighter/hulk)	
Hull Points	30
Weaponry:	Laser Cannon Assault Rocket Launcher, 2 Rockets
Defences:	Reflective Hull*
Damage Control Rating (DCR)	20**
Acceleration/Deceleration Factor (ADF)	1/4***
Manoeuvre Rating (MR)	1

\* The reflective hull only covers part of the ship. There is a 60% chance that a shot on the Lizzie Borden will hit an area without defences.

\*\* The low DCR reflects the fact that the ship is built from salvaged parts — and that the computer cannot cope with the complexity of the problem this presents.

\*\*\* The Lizzie Borden normally uses ion drives (ADF 1), but at some point in the crew salvaged a C type atomic drive which is now attached to one of the ship's drive struts. In emergencies this drive is used to give the improved ADF.

The referee should note that no deck plans are provided for the Lizzie Borden — the crew will not allow anybody on board the vessel in any circumstances. If the adventurers try to take it by force the referee should use the small freighter plans supplied in the Knight Hawks set.

Gosht-e-nan, a Yazirian, is the leader of the Lizzie Borden's crew, a group of acquisitive souls who live by one motto: 'If it's not nailed down, it's ours; if we can prise it free — it's not nailed down!' Gosht-e-nan wants to strip the wreck of the Clan Chattan for spare parts to improve the Lizzie Borden. He will agree to Lt Brett's landing conditions, confining his larcenous intentions to the Clan Chattan.

There will never be more than two members of the Lizzie Borden's crew working away from the ship at any one time (Steinman will never leave the ship). They will remove all the useful components of the Clan Chattan that are relatively intact — the computer, the escape pod, the electronics on the ship bridge. They will then turn their attention to the cargo pods, and if not watched will load the contents of pods 4, 5 & 6 into the Lizzie Borden's hold.

If they are stopped, they will become hostile. They will retreat to the Lizzie Borden, and after 1d10 hours will attack the adventurers, though again, never more than two of the wreckers will leave their ship.

If they are defeated, they will once again retreat to their ship. Gosht-e-nan will attack the Paltsa Ryby using the laser cannon. The instant that the Lizzie Borden suffers damage, they will accelerate away from Plutarch using the atomic drive.

The referee should play these NPCs as thoroughly shifty, disreputable types — who will (and have) slit throats for the price of a drink.

### The Wreckers

Name	STR/STA	DEX/RS	INT/LOG	PER/LDR	IM	RWt	M+
Gosht-e-	30/50	60/65	40/30	35/60	7	90	50
Steinman	40/60	45/45	40/50	30/45	5	33	25
Tyler	60/40	70/65	35/50	75/25	7	55	35
Todd	5/15	80/90	60/75	50/45	9	60	40
Angel	95/40	20/20	05/05	01/01	2	10	43

#### Skills:

Gosht-e-: Beam Weapons 6, Gunnery (Energy Weapons) 3, Melee Weapons 2

(Yazirian Male) Battle Rage 35.

Steinman: Beam Weapons 1, Computer 6, Technician 6, Pilot 2, Astrogation 3.

(Human Male)

Tyler: Martial Arts 3, Projectile Weapons 2, Technician 4, Robotics 3, Engineering 3.

(Human Female)

Todd: Beam Weapons 1, Projectile Weapons 2, Martial Arts 1, Medical 1, Psycho-Social 2. (Human Male)

Angel: none.

(Yazirian Male) Battle Rage 50.

Base chance to hit does not take into account Yazirian Battle Rage or Martial Arts skill

All have space suits and armour. Gosht-e-nan and Steinman are armed with laser pistols and vibroknives, while Todd has a laser rifle. Tyler uses a pair of matched sawn-off shotguns with three-round clips (see **New Equipment**). If a fight breaks out Angel will be allowed to use an axe — as a special treat.

## Ending the Adventure and Experience

Effectively, the adventure ends when the Paltsa Ryby arrives at Laco starport and offloads the cargo. Glaz Ptitsy will be paid by LDC, and will then pay the adventurers. This will take about a week or so while the LDC management argue with Glaz over the state of the recovered cargo and its value.

The referee should award 5 experience points to those characters who performed well, 3 to those whose performance was adequate, and 1 to those 'along for the ride'. A bonus of 10 experience points (divided in any way the referee sees fit) can be awarded to the adventurers as a group for an exceptional performance (eg for dealing with the potential opposition in a diplomatic manner without the use of guns etc).

## Credits

Design:  
Artwork:  
Cartography:

Mike Brunton  
Alan Gambriel  
Paul Ruiz

# The Sarafand File

## Paul Vernon & Sean Masterson

### Source Files

Central Records, Cartographical Service  
Ship of Strangers, Bob Shaw

All the sections of this **TRAVELLER** and **STAR FRONTIERS**® game adventure file, except the **Mission Profiles**, may be given to players at the start of play in addition to any normal referee's briefing. The information in these sections is readily available to the player characters. **IMAGINE**™ magazine grants permission for referees to photocopy the relevant sections for their personal use only.

## THE CARTOGRAPHICAL SERVICE

Beyond the volume of explored and colonised space — the Bubble — preliminary surveys by unmanned probes are continuously carried out. The diplomatic and military arms of government are given responsibility for those systems and worlds which apparently support intelligent life. The vast majority of systems have no planets within their star's ecosphere or have not yet evolved intelligent life. Mapping these systems for later exploitation is the purpose of the Cartographical Service.

To perform this task, the Cartographical Service utilises specially designed exploration vessels, of which the **Sarafand** is a typical example. Although the ships have a crew of 12 to 15 members, command of the ship and the survey missions are the responsibility of **AESOP**. The **Sarafand**'s crews have always thought **AESOP** to be Advanced Electronic Spaceship Operator and Pilot. Crew duties are confined to piloting individual Survey Modules — not-so-small go-anywhere exploration vehicles — as it has been found practical to have a human element within the system to cope with the unexpected.

### The Cartographical Service and RPGs

Survey vessels such as the **Sarafand** make an ideal base for adventurers. The crew roster is small enough for player characters to be influential, while even smaller groups can adventure as the crews of Survey Modules. However, a few modifications do need to be made to Bob Shaw's technological background to suit the needs of role-playing games, and the technological backgrounds of the game systems.

**AESOP**, the ship's computer and master, is by far the most influential character in the *Ship of Strangers* stories. Although this makes the book interesting, as a part of the game it is likely to be very unsuccessful, as player interest is almost certain to be diminished by being ordered about by a computer. The responsibility for decision-making has to be returned to the players, and this entails giving **AESOP** an advisory, rather than controlling, role in the **Sarafand**'s command structure. In *Ship of Strangers* there are only 12 crew members plus **AESOP** as mission commander. In this file there are 15 members, the extra humans being command staff.

A final problem with the missions undertaken by a **Sarafand** class explorer is that many of them are boringly routine, which does not aid in making the game exciting. One way to avoid this is to run the player characters' very first survey as a dull, routine affair to 'show them the ropes' and then use the out-of-the-ordinary mission profiles, stressing how many dull surveys there have been between moments of interest and excitement. There might be 10-60 dull missions between specially profiled occurrences.

## TRAVELLER

The Scout Service of the Imperium (see **Scouts**, Book 6) includes, among its offices and branches, the External and Internal Mapping Branches of the Imperial Grand Survey. These two parts of the Grand Survey have roughly the same responsibilities as the Cartographical Service of *Ship of Strangers*. Simply renaming the Cartographical Survey as the Imperial Grand Survey (or vice versa) is all that is required.

The Imperium of the official **GDW Traveller** universe leaves scouts with very little mapping to do, as the Imperium is a mature state which has expanded to fill much of the available surrounding real estate. If the suggestions in **Uncharted Stars** (see **IMAGINE** magazine, #19) are followed, they will provide numerous locations for potential adventures for members of the Cartographical Service.

## The STAR FRONTIERS game

The **Knight Hawks Campaign Book** includes an option for characters to become officers in the UPF Spacefleet (p48-50), but this may not be entirely suitable for many campaigns. The Cartographical Service gives referees a chance to provide a consistent backdrop for adventures together with a chance for player characters to see a bit more of the universe than is normally possible.

The Cartographical Service of the UPF is an entirely independent arm of government (although it was once part of Star Law), with its own command structure, bases, ships, training academy, budget and operational commitments. It exists solely to survey planetary systems, collate such information from the corporations and maintain and issue maps, star catalogues and geological data.

### Safax Institute

The headquarters of the Cartographical Service is at Triad in Cassadine, part of the main UPF facilities in that system. It is here, at the Safax Training Institute on Triad's moon, that the future crews of exploration vessels are given their initial training.

Applicants for the Cartographical Service are 'stable, well adjusted and intelligent' but do not require any relevant skills. INT/LOG and PER/LDR must be above 45, and non-human applicants have a 75% chance of being rejected regardless of their qualifications (single species ships make long periods of confinement while on survey missions easier to bear).

Training in the use of the Survey Modules (the equivalent of Technician 4 subskill Operate Machinery) is provided by the Cartographical Service. Computer 2, Technician 2, Medical 2 or Environmental 2 and a level 1 Military PSA skill are also taught to the character at Safax. This training procedure supercedes the normal starting skill allowance if the entrant characters are newly created.

### Advancement

After training at Safax, characters are expected to serve at least two years aboard one of the Cartographical Service's exploration vessels (obviously, administrators and support personnel are required, but these are non-adventuring posts filled by NPCs). The two year minimum requirement is mandatory; hospital time, for example, is not counted towards service time or paid as such (although the Cartographical Service does pay for treatment).

In-service training is considered worthwhile, and is often one of the few ways to pass the time during missions. Characters may continue to spend experience points and acquire new skills through hypno-training, practice or training while on missions. Length of service and skills both contribute towards character advancement within the pay structure of the Cartographical Service. Leadership of teams usually falls upon the shoulders of the most experienced crew members or the natural leaders of the group. As long as the job gets done, the Cartographical Service does not mind how individual ships are organised.

Qualifications	Daily Pay
Up to 2 years	100
Up to 6 years or at least 40 experience points worth of skills	300
Up to 12 years or at least 80 experience points worth of skills	500
More than 12 years or at least 150 experience points worth of skills	650

The Service provides no retirement benefits for employees.

## CREW

The ship's crew of a typical Sarafand class vessel is usually a mixed bag, with only one or two long term members. The rest are short assignment, limited contract personnel.

Most crew members serve for two two-year periods before leaving to pursue projects of their own with the money that they have earned. There are, however, one or two veteran crew members aboard most ships, providing a valuable steadying influence. The Cartographical Service is seen more as a stepping stone to other things than as a profession — though the work itself is monotonous and unsocial, the pay is excellent (at least double the rates paid by commercial corporations for people with the same skills), even though the opportunities for spending it are somewhat limited.

When surveying a planet, the team leader, computer operator and one other crew member stay aboard the Sarafand in order to monitor data as it is received from the Survey Modules. The remaining 12 crew members provide crews for the Survey Modules.

## TRAVELLER

1. Pilot/Team Leader, UPP 5A78C9, Terms 5, Pilot-4, Leader-2, Nav-2, J-o-T-1, Veh\*-1, Gun Cbt-1.
  2. Navigator, UPP 4867C6, Terms 5, Pilot-1, Nav-3, Elec-2, Comp-1, Gun Cbt-1.
  3. Medic, UPP 3877B5, Terms 5, Medic-3, Vacc-2, Gun Cbt-2, J-o-T-1, Veh\*-1.
  4. Computer Operator, UPP 685988, Terms 4, Comp-4, J-o-T-2, Gun Cbt-1, Pilot-1.
  5. Leading Engineer, UPP 9A8967, Terms 4, Engrg-3, J-o-T-2, Gun Cbt-2, Veh\*-1.
  6. Engineer, UPP C79778, Terms 3, Engrg-2, Gun Cbt-1, Elec-1, Mech-1, Veh\*-1.
  7. Engineer, UPP AB9C98, Terms 3, Engrg-2, Pilot-1, Veh\*-1, Mech-1.
  8. Engineer UPP 687DB7 Terms 5 Pilot-1, Gun Cbt-2, Medic-1, Mech-3, Veh\*-2, J-o-T-2.
  9. Engineer UPP 788A96 Terms 2 Engrg-1, Veh\*-1, Gun Cbt-1, Elec-1.
  10. Engineer UPP 9838B5 Terms 2 Engrg-1, Veh\*-1, Mech-1, Gun Cbt-2.
  11. Leading Gunner UPP 79DA77 Terms 5 Gunnery-4, Gun Cbt-2, Veh\*-1, Comp-1, Elec-1.
  12. Gunner UPP 59385A Terms 2 Gunnery-1, Veh\*-1, J-o-T-1, Gun Cbt-1.
  13. Gunner UPP A97468 Terms 4 Gunnery-3, Vacc-2, Mech-1, Veh\*-1.
  14. Gunner UPP 5A9767 Terms 3 Gunnery-2, J-o-T-1, Veh\*-1, Elec-1, Gun Cbt-1.
  15. Gunner UPP CA8569 Terms 2 Veh\*-2, Gunnery-1, Vacc-1, Gun Cbt-1.
- \* Vehicle skills (Veh) pertain to driving the Sarafand Survey Modules.

## The STAR FRONTIERS game

The crewing policy of the Cartographical Service in the **STAR FRONTIERS** game reflects the fact that *Ship of Strangers* is set in a human universe. Mixed species crew are not usually employed aboard Sarafand class vessels, and few non-humans ever bother to apply for this type of repetitive and boring work, even though it is highly paid.

The 15 crew members, other than the two or three 'oldtimers' aboard most ships, are only expected to have enough skills to operate the vessel under normal conditions, while relying on **AESOP's** self programming ability for major problems. Typically, Computer 2, Technician 2, Medical 2 or Environmental 2 and some military PSA skills are required by short term crew members. Training in the use of Survey Modules (the equivalent Technician 4 subskill Operate Machinery) is provided by the Cartographical Service. Characters can then fully operate the Survey Modules in normal circumstances. Success rolls (at the referee's discretion) may be needed under exceptional conditions.

Long term crew members usually have spaceship skills and appropriate foundation skills as well. The 'captain' of a Sarafand class vessel usually has minimum skills of Technician 6, Computer 6, Piloting 4, Astrogation 2 (or System Navigation 3) and Weapon 3, while the other 'oldtimers' are similarly skilful in their areas of competence, including the new Astronomy skill detailed below. One of the long term crew members will usually be designated as the ship's weaponry officer in addition to any other duties, and will have Gunnery (Energy Weapons) 3, although this character need not have the relevant Beam Weapons 6 skill (this is an exception to the normal foundation skills requirement for this NPC only).

The description of the Cartographical Service at the beginning of this file outlines its use as an alternative career to the UPF SpaceFleet (see **Knight Hawks Campaign Book**).

## New Skills for STAR FRONTIERS characters

	Cost					
Level:	1	2	3	4	5	6
System Navigation	6	12	20	30	50	75
Astronomy	As other Technological skills					

## ASTRONOMY (Technological)

The study of stars, galaxies, planets, moons, asteroids, comets and meteors, their conditions and origins.

This skill has two sub-skills: Identify and Calculate. Astronomers must make observations to perform either subskill, using telescopes, radar, energy sensors, cameras and computers. Each type of equipment astronomers use to make their observations adds 10% to their chance of success.

### Identify

Success Rate: 10 x skill level + equipment

Astronomers can identify objects in space, from planets to spaceships. Identifying takes half an hour for objects closer than 10,000 kilometres. Objects further away take 1 hour to identify.

### Calculate

Success Rate: 10 x skill level + equipment

Astronomers can calculate the age, speed, mass or orbit (course) of any object in space. Astronomers can only make one calculation at a time. Each calculation takes half an hour.

## SYSTEM NAVIGATION (Spaceship)

This skill is used to guide a ship (usually one incapable of interstellar travel) within a star system. As such, it is a partial replacement for the Astrogation skill given in the **Knight Hawks Campaign Book**. System Navigation requires foundation skill of Computer 2.

### Plot Course

Success Rate: 40% + 10% x skill level — 10% per hour less than required plotting time

Navigators make the complicated calculations required to plot a safe and accurate course for a spaceship. The time needed for course calculations increases for longer trips, because even small errors become very serious as the distance increases. The required plotting time is one hour per 100,000 kilometres that will be travelled. Navigators can cut the required plotting time in half by using computers to aid them (typically with Analysis programs).

If the navigator spends less than the required plotting time, his success rate is reduced. Every hour of the required plotting time the navigator does not spend reduces his success rate by 10%.

If a navigator fails the plot course roll, an error has been made, and all the calculations must be made again.

## MISSION PROFILES

Cartographical survey missions are supposed to follow the same, invariable pattern. On arrival in a target system, the plane of the elliptic is determined and the first planet for scanning is chosen. The exploration ship orbits the planet, deploying three communications satellites into geo-synchronous orbits above the equator, and then lands at one of the poles. The Survey Modules are launched, and they fly (or drive) over preset courses which are plotted to allow the entire surface of the planet to be scanned by the Module sensors. Data is transmitted to the ship via the satellites.

Meanwhile, the ship takes off and lands at the opposite pole to await the arrival of the Survey Modules. Once all the modules have been recovered, the ship then leaves for the next target world. Work for the Cartographical Service is, for the most part, very boring....

The following scenario outlines are given in **TRAVELLER-style 76 Patrons** format, which will be unfamiliar to **STAR FRONTIERS** referees. An outline of the situation is presented, but the specific details are left largely to the referee to determine, based on the experience and temperament of the players involved. If the scenarios are used as a basis for a campaign, Mission Profiles 1 & 2 should be run consecutively, for reasons that will become apparent.

## 1. THE OUTCAST

During the routine survey of Helat 4, a particularly worthless world, the NPC crew of one of the Modules, Straker and Kaminsky, pick up readings of a large concentration of metal and a power source. **AESOP** advises an investigation, and all the other Modules are halted while Straker and Kaminsky head for the source of the enigmatic readings.

The other crews watch on their video screens as the investigators cross a ridge line and discover, half hidden in drifting dust, the skeleton of a starship. Kaminsky suits up and heads into the wreck on foot, his shoulder camera carrying the view to the rest of the Sarafand's crew....

Inside the ship is a wreck, skewered by a meteorite before it crashed. The bridge area is relatively intact, and Kaminsky manages to struggle to the pilot's position and extract the log tapes. He also finds the remains of the pilot, with a jagged hole in his helmet and skull and a corroded automatic pistol clutched in his hand.

When transmitted to **AESOP**, the log tapes prove to be from the commercial explorer Outcast, lost ten years ago. A comparison with **AESOP's** library data reveals the ship's last position was 10 light years away.

The rest of the survey is as boring as usual, and all the Modules reach the Sarafand at Helat's North pole without further incident. In the meantime, **AESOP** has analysed the log tape, and discovered that the crew of the Outcast fell victim to a terminally debilitating spinal infection. Only the navigator, who had a prosthetic pelvis and spinal column, was immune, and he purposely brought the ship to Helat 4, well away from any inhabited worlds. Kaminsky and Straker are sent to the sickbay, but both are perfectly healthy. Kaminsky is very upset by the scenes he saw aboard the wreck of the Outcast, and cannot even talk about it. He begins to withdraw from conversation, and to brood.

The Sarafand boosts out of the Helat system towards its next target, and as the last calculations before the Jump are being made, the subject of the Outcast comes up in conversation. Kaminsky lashes out at the nearest person (one of the player characters) and then retreats to his room, locking himself in and everybody out.

Next morning, Kaminsky does not appear at breakfast, and when somebody is sent to his room the door is open and Kaminsky is lying in his bed, dead. Something has gnawed its way out of his stomach....

### Referee's Information

Kaminsky has fallen victim to the same 'disease' as killed the crew of the Outcast. In fact, the creature that killed him was roughly the size and shape of a Terran woodlouse, although infinitely more dangerous. The creature has used Kaminsky as a nest, and its young (2-12 specimens) are now at large.

The creature (the player characters may have the privilege of naming it) attacks warm-blooded creatures in order to feed and reproduce. It climbs to a point on the victim where nerve impulses are particularly strong (the base of the neck hidden under the hair on a human) and there inserts its proboscis into the central nervous system, deadening all sensation with a powerful natural anaesthetic. Once established, it suborns its victim's nervous system to protect itself and in the process produces changes in behaviour, until ready to reproduce. The creature then paralyses its victim and migrates to a suitable nest — the stomach or chest cavity are nearly perfect. There it lays its eggs (the creature is asexual) and dies, killing the host as it does so. Six hours later the eggs hatch and the young eat their way out, looking for new nest sites....

Once the takeover has begun, the resources of the Sarafand are not sufficient to halt the process in a 'nest' person. However, the creatures can be stopped by systematically decompressing the ship. If the adventurers follow this course of action, the referee should judge how successful their measures are, and may choose to give hints that the PCs should not necessarily assume there is more than one creature. The referee should also feel free to have another crew member (preferably an NPC) fall victim to the creatures, producing another 2-12 young.

If the adventurers succeed only in containing the creatures, it will be covered that the life support system is overloading, despite the death of Kaminsky (and any others). Despite their small size, the creatures consume as much oxygen as a man....

### Traveller:

2-12 Eaters Weight 0.01kg; Hits 1/0; Wounds/Weapon Special; Armour Jack (DM-3 to hit), A0, F9, S1

### The STAR FRONTIERS game

2-12 Tiny Carnivores MV Slow; IM/RS 2/16; STA 18; ATT 90; DAM Special; NATIVE WORLD: Unknown.

## 2. SABOTAGE

In this scenario, one of the NPCs or (more interestingly, perhaps) one of the player characters should be an agent for the Sathar or Zhodani....

The referee should roll 1d6.

1. The Sarafand has been assigned to survey the supposedly uninhabited world of Yazrin 3. In fact, the planet is an enemy supply dump for their long range spyships. The enemy agent aboard the Sarafand will stop the mapping if possible or, if the base is discovered, he or she will set about eliminating the crew.

2-3. While the ship is in hyperspace, the agent sabotages **AESOP**. With the computer partially disabled, the crew face the prospect of spending the rest of their (somewhat limited) future in the terrible void. **AESOP** must be repaired, but once this is done, the presence of a saboteur will be revealed. Obviously the agent must take steps to avoid discovery.

4. One of the player characters is implicated as a spy and assassin. The agent has planted incriminating documentation in the player character's possessions.... This particular line of adventure works well if the referee takes the accused player aside at any earlier point to impart some information of a trivial nature — but out of earshot of the other players.

5-6. If Mission 1 **The Outcast** (see above) has not been used, then roll again. If it has, the agent is a fanatic, unafraid to die for the cause, and has captured one of the creatures. Another outbreak of the creatures is the result, as the agent uses the creature to murder an NPC.

## 3. THE HAL SYNDROME

After entering the barren Quettyr system and surveying the planet Victoria II, **AESOP** malfunctions. During a meal time, instead of delivering the requested items, **AESOP** orders the galley to produce an endless stream of cold porridge. The computer's behaviour becomes more and more 'quirky' and starts to endanger crew lives, apparently intentionally.

For example: **AESOP** leaves the outer airlock door open and allows the inner door to be opened — only the emergency locks shut the hatch, but not before several crew members have suffered (mildly) from explosive decompression; **AESOP** locks the crew out of the engine room and bridge, and begins to broadcast an endless succession of ancient songs (in particular, *Oh, Mr Porter* and *I Like to go Swimming with Women*) over the ship's intercom system; and **AESOP** begins to refer to the Captain as 'Moriarty' and only speaks when addressed as 'Holmes'.

1-3. **AESOP's** central processor has been damaged by stray radiation. The computer must be stripped down and the damaged circuitry removed.

4-5. **AESOP's** errant behaviour is the result of a carelessly worded order to search the library banks. Instead of extracting information about the planet Victoria II, **AESOP** has accessed data about the Victorian Era and wrongly rewritten his main program. Purely by chance, the Victorian file marker was at the 'M's' — including Moriarty, Murder and Music Hall.

6. **AESOP's** behaviour is the result of manipulation by Cartographical Service headquarters. The crew are being subjected to a carefully controlled stress pattern to see how they react. **AESOP** is monitoring the crew and will terminate the exercise once they devise — and begin to implement — a strategy that he feels will remedy his 'madness', or earlier if he or the ship is in danger of destruction.

## 4. TANZIN 2

Tanzin is a K8 main sequence star with a planet positioned almost ideally in the ecosphere. After the initial probe report, a Contact mission was organised and despatched, but Tanzin 2 proved to be a great disappointment. As the Contact ship orbited the planet, it became clear that T2 was a barren and unpleasant world. Pausing only to skim the top of the oxygen-free atmosphere for samples, the Contact mission returned, the Tanzin file was given to the Cartographical Service, and the player characters' vessel was despatched to map the world — just so the files can be closed.

Although T2's gravity proves to be slightly weaker than standard, NOE flights and surveys prove to be impracticable due to the frequent and violent storms in the planet's atmosphere. All is apparently routine, despite some minor problems like wheel changes and a broken half-axle on one of the Survey Modules. The exploration of T2 proves to be as dull as it could possibly be, with no evidence of life, and no evidence as to why life never got started, despite the fact that it does not have the normal type of primeval atmosphere associated with lifeless worlds. The only moment of excitement is when one of the PC crews picks up readings of a cavern system in an inappropriate series of rock formations.

Tanzin's condition is due to the release of a potent biological weapon into the atmosphere of the planet over 5,000 years ago. The spores mutated as soon as they were out of the laboratory, and attacked all life, using up tremendous quantities of oxygen is the process. Eventually, the biosystem broke down completely and all life on Tanzin 2, from the bottom of the ocean to the tops of mountains was dead. The oxygen in the atmosphere was locked into complex chemical compounds. During the intervening millenia, the spores have been dormant, but now some have been revitalised by being carried into a Survey Module on the suits of the crew who repaired the half-axle.

The initial symptoms of infection by the spores, which appear after 12 hours, are tiredness, nausea and blurred vision. The infected crew are already suffering from these symptoms, although it is hardly surprising that they are tired after the drive from South pole to North pole. Twelve hours after that, the symptoms will grow progressively worse, with a general lassitude, muscular aches and complete loss of appetite overcoming the victim. The spores are infectious once the initial symptoms have appeared.

**TRAVELLER** characters undergo the equivalent of rapid ageing (though without obvious physical effects such as greying hair etc), treating 1 hour as 1 year for the purposes of the spores progression, and rolling on the ageing table every four hours once 'old' enough to do so. Characters who have a characteristic reduced to zero go into a coma; if a characteristic drops below zero, that character is dead. Medical skill gives a DM of +1 per level of skill to the ageing saving throw.

Characters in the **STAR FRONTIERS** game suffer an S8/D1000+ infection. Characters using the Medical Cure Infection subskill suffer a 30% chance of success and will only halt the progress of the spores for 10 hours. Another successful Cure Infection roll is required every 10 hours to stave off the effects of the spores.

The only chance of defeating the spores is to examine the strange cavern formations some 3,000 km from the pole. These caverns are a military research bunker from 5,000 years ago, the last attempt the Tanzinites made to defeat the spores.

Once there, the bunker is in remarkably good condition as it has been sealed since the disaster. If **AESOP** is given samples of the written language (transmitted to him via suit video cameras) found in the bunker, he can analyse and translate it in 1d6+6 hours. The Tanzinites were close to a breakthrough, but the spores eventually won....

Medical 2 will allow a character to understand the nature of the Tanzinite research into the spores, and a roll of 9+ (**TRAVELLER**, DMs +1 per 4 hour period spent in analysis, and this can be repeated every four hours, but no treatment can be administered to spore victims during this time) or a successful Cure Infection roll at -40% (+10% per ten hour period spent in research, and the roll can be repeated after a further 10 hours, although Cure Infection rolls on patients will not be possible during a period so spent) will provide the necessary antidote.

## 5. THE BONUS

While surveying the planetary system of Oula, the F8 star in a binary system, it is discovered that the F3 companion star also has a planet, one that the initial robot probe missed completely. This kind of discovery occurs all the time, so mission commanders have the authority to alter the mission profile and explore newly discovered worlds in addition to those already targetted for mapping. As such initiatives are approved of by headquarters, the crew often get the chance to 'enjoy' longer 'Bonus' missions and see another very boring world.

The survey of Oula 2/1 begins by following the usual routine. Soon after the ship lands at the second pole, however, the module crews (including the PCs) are contacted by the ship with the message that "We've just discovered...." before contact is lost completely.

1-2. The communications satellite linking the ship and the modules has been struck by a tiny piece of anti-matter and destroyed. Contact is re-established when (or if) the modules move into the zone covered by

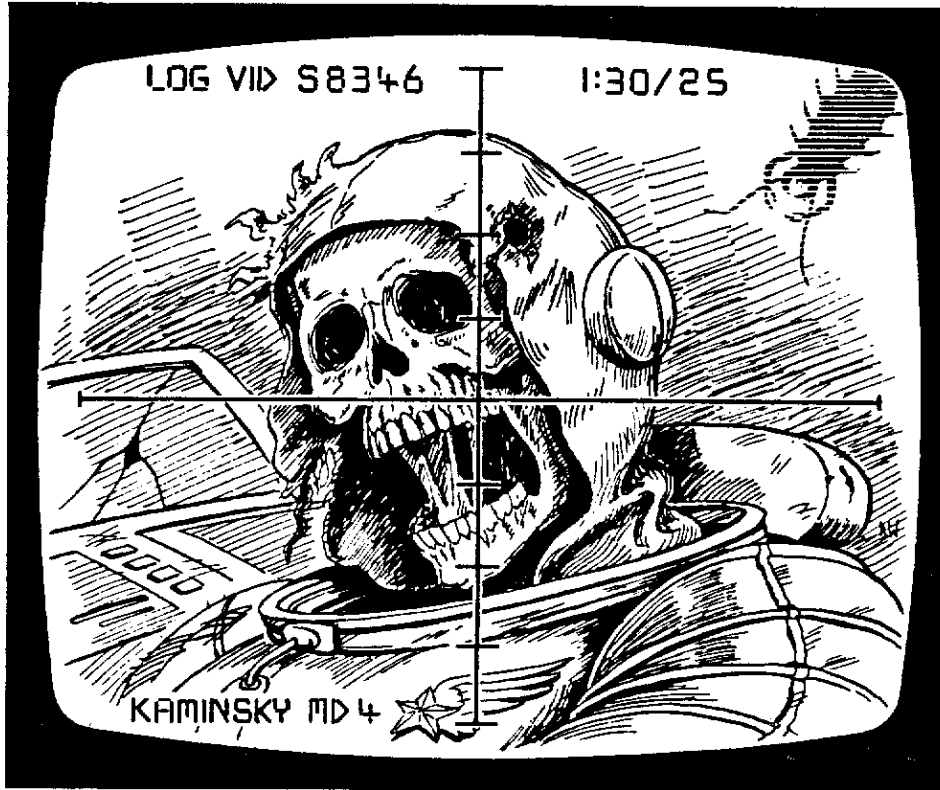

another satellite. There is a 1 in 6 chance that the one of the other satellites will suffer a similar fate, or that the ship will be damaged before it leaves orbit.

3-4. The planet is very rich in superdense elements, which are being mined by a large corporation without the knowledge of the authorities or any competitors. To protect their interests, the company have destroyed the satellites with a missile, and have stationed armed teams to make sure the Survey Modules do not return to the ship.

Although the ship itself is too strong for the corporation's men to handle, one of their own armed vessels will arrive in 2-12 days.

5-6. As in 3 above, except that the mining operation is being conducted by hostile aliens, Zhodani or Sathar, depending upon the game system.

## CONCLUSION

Those seeking ideas for further adventures need look no further than *SHIP OF STRANGERS*, the novel of Bob Shaw from which the **Sarafand** and the Cartographical Service are taken.

The missions outlined above need not be the only use to which the **Sarafand** is put. The potential for continued use of the **Sarafand** in a campaign is enormous, as it allows the referee to introduce almost anything without too much disruption of what has gone before, and gives the player characters the feeling that they are exploring virgin territory and that they matter (in a small way) in the overall scheme of things.

The authors would like to thank Bob Shaw for his assistance in supplying the necessary background material which made this article possible.

## CREDITS

Inspiration: Bob Shaw  
 Original Design: Paul Vernon & Sean Masterson  
 Development: Mike Brunton with Jim Bamba  
 Art: Brian Williams

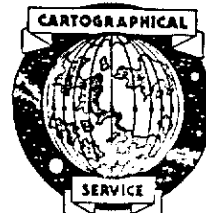

# THE SURVEY MODULES

## TRAVELLER

The Survey Module statistics for TRAVELLER are given below in STRIKER format.

### Cartographical Service G-Carrier (TL13)

Height: 3m (plus communications turret, 1.2m)

Width: 3m

Length: 6m

Total volume: 51 m<sup>3</sup> (useable volume 44.3m<sup>3</sup>).

Weight: 41.3 tons

Price: 883,888Cr

Max Road Speed: 265(+)<sup>+</sup> kph

Cross Country: 53(+)<sup>+</sup> kph

Water Speed: 13(+)<sup>+</sup> kph

Max Grav Speed: 540 kph

Cruise Grav Speed: 405 kph

NOE: 170 kph

Armour: 11

Target Size DMs: +1 high, +2 low

Equipment: searchlight and image enhancement output to view-screen; 5000 power radio; 500 power radar sensing equipment; geological sound ranging gear; battle computer programmed to handle geophysical data.

Power: 6 megawatt fusion powerplant (consumes 9 litres of fuel per hour, fuel capacity of 7560 litres gives 840 hours of operation). Grav generators produce 1.453g.

Survey Modules see service in a wide range of planetary variations and are designed with this in mind. In addition to being capable of both surface and grav movement, they are built to travel over or under water where necessary.

The maximum awareness radius of the sensors carried is 500 kilometres, and they are sensitive enough to register all necessary data when the vehicle is travelling at speeds up to 170kph (NOE speed in grav mode).

On a planet with a gravity in excess of 1.453g, grav mode is impossible and the grav generators are used to improve the power to weight ratios for ground movement (hence the + signs after the figures given for ground speeds). When grav mode is not feasible for any reason (eg atmospheric disturbance), the grav generators are often used to keep the survey modules on the ground. They are also used to provide the required buoyancy during marine travel. While on surveys, the average speeds achieved are 80 kph (ground movement) or 160 kph (NOE).

As the crews (driver and co-driver) are often confined to the vehicles for days at a time, their living accommodation is quite extensive. Three tons of cargo capacity is taken up by the supplies and spares necessary during long treks in the wilderness.

## The STAR FRONTIERS game

Cost: Cr 100,000 (rental is inapplicable)

Top/cruise speed: 90/50 kph

Water/NOE speed: 10/100 kph

Turn speed: 40 m/turn

Passengers: 2

Cargo: 10,000kg or 40 cubic metres (3,000kg of spares and equipment, the rest is allocated to crew quarters).

The Cartographical Service Survey Module is a heavy, long range version of the standard Explorer van, hardened (100 + d100 structure points) against a wide variety of external conditions and capable of a rocketed-assisted Nap of the Earth (NOE) flight. The Survey Module is powered by a type 4 hydrogen fusion generator with 850 hours of fuel in reserve, giving a range of operation of 80,000 +km. Life support for the crew of two (driver and co-driver) is also provided for this length of time.

The Survey module carries a long range detector system (500km range) which includes radar, energy sensors (see the Knight Hawks Campaign book) and geological sensors, a camera system with IR enhancers, a video radiophone including a computer data transfer system, two spacesuits (for hostile environments) and a level 3 computer (powered by the module's generator). The computer runs Analysis 4, Information Storage 4, Communications 2, Robot Management 3 (to run the sensor packages) and Life Support 1 programs.

A civilian version, lacking the geological survey sensors and flight capability, is manufactured and sold for Cr 85,000.

## APPROVAL

372/399/4	<i>[Signature]</i>
05732A7	<i>Later in Track.</i>

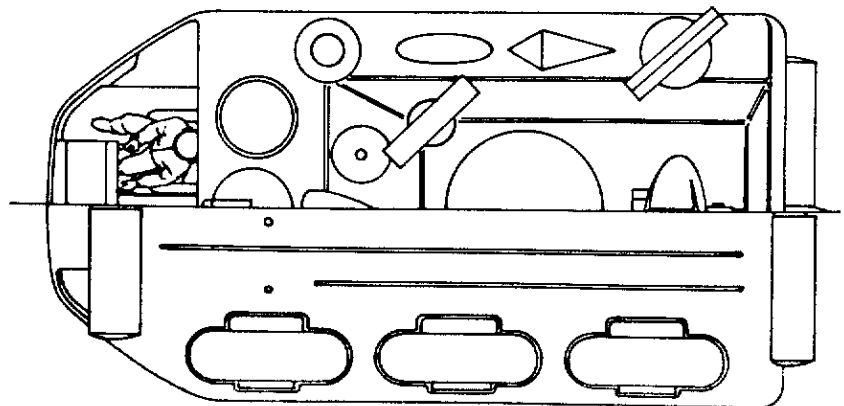
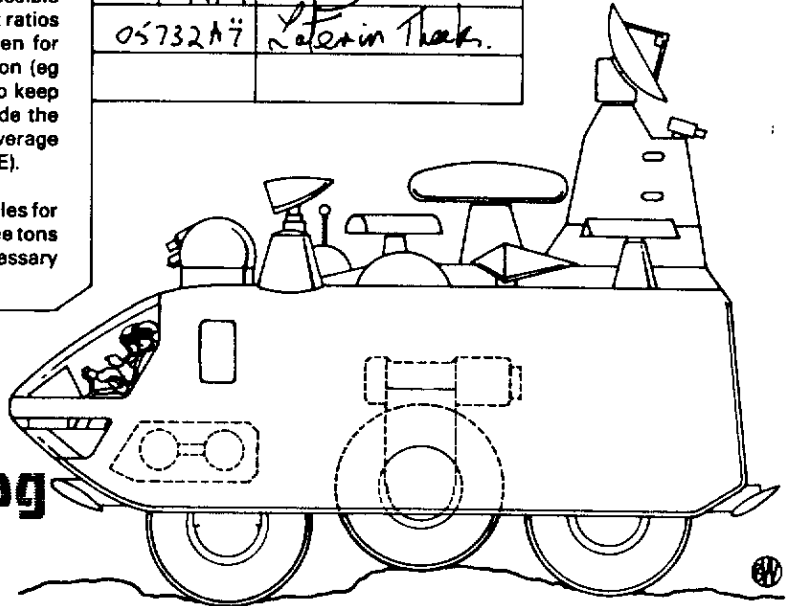

**DUPLICATE**

**Williams Engineering**

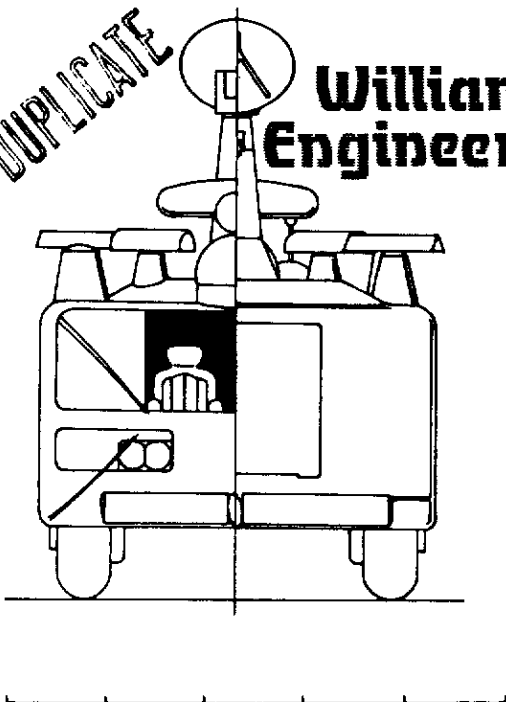

# SARAFAND (Cartographical Service Mark 6 Exploration Ship)



Williams  
Engineering

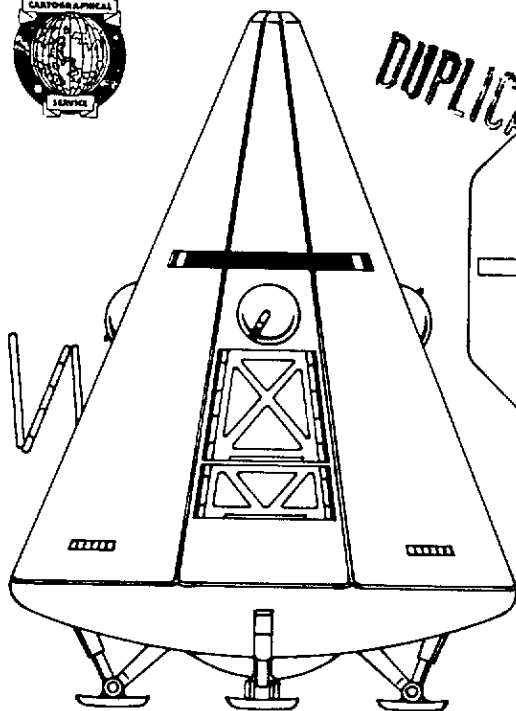

DUPLICATE

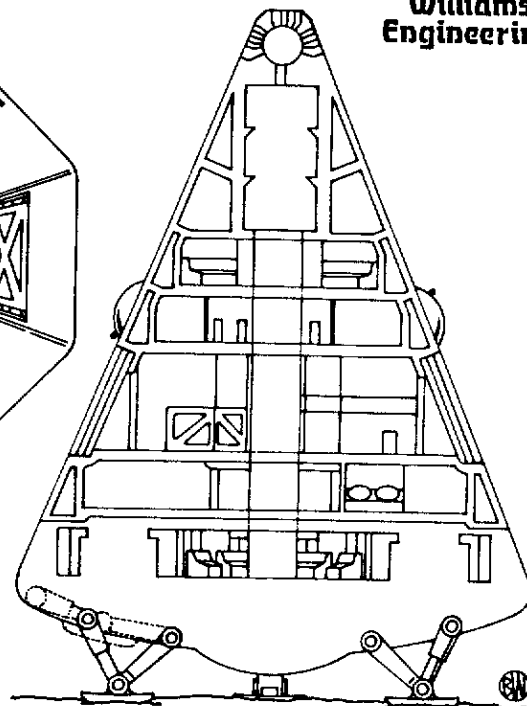
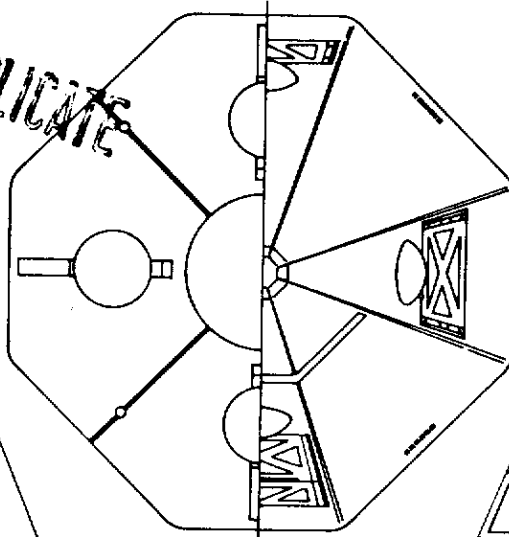

02/3/5	W. J. ...
3323	Thoonka

## TRAVELLER

The Sarafand class is built on an 800 ton hull and used to carry a survey team and their survey modules to previously unmapped planetary systems. Its jump drive-4, manoeuvre drive-4 and power plant-4, give jump-4 and 4-g acceleration (Book 5, 2nd Edition design), and the fuel tankage of 352 tons supports 4 weeks of power plant operation and one jump-4. An onboard purification plant is carried. The hull is streamlined for wilderness refuelling and planetary landings.

The computer system, installed adjacent to the bridge, is a model/7 fib. Eight turrets are installed at launch, four carrying a pair of fusion guns each and four with two missile racks and a sandcaster each.

On a large hangar deck, the ship carries six survey modules for planetary scanning, each displacing 10 tons. The cargo capacity of 78 tons is used to carry the supplies and comprehensive range of spares required for deep-space operations away from maintenance facilities.

The crew of fifteen (pilot/team leader, navigator, medic, computer operator, six engineers and five gunners) have their own staterooms. All except the pilot and computer operator act as survey module crews in addition to their ship-board duties.

The Mark 6 Exploration ship takes 25 months to build and costs 660.156Mcr (fully equipped); 20 months and 528.124Mcr if constructed in bulk.

## High Guard Statistics (2nd Edition)

### SJ-374 SARAFAND

SJ-81444G2-030000-05003-0	Mcr 660.156	800 tons
Batty Bearing 4 2 2	Crew = 15	TL = 13
Passengers = 0 Low = 0 Cargo = 78	Fuel = 352 EP = 32	Agility = 1

## The STAR FRONTIERS game

SHIP'S NAME: Sarafand (class)  
OWNER: UPF Cartographical Service  
CAPTAIN ABOARD: Team Leader (with AESOP)

HULL SIZE: 3  
ENGINES: 2 x A Atomics — De-rated UPF Triad Shipyards Type 42's  
FUEL: 3 pellets/engine  
COST: Cr 1,502,300  
CREW: 15  
CREW SALARIES: Variable

LIFE SUPPORT CAPACITY  
MAIN: 18  
BACKUP: 0

PASSENGER ACCOMMODATION:  
FIRST: 1  
JOURNEY: 14  
STORAGE: 0

COMMUNICATION EQUIPMENT: Videocom, intercom, subspace radio

OTHER EQUIPMENT: Radar, full camera system, energy sensors, skin sensors, 6 x survey module

ADF: 3  
MR: 4  
DCR: 29  
HULL POINTS: 15  
WEAPONS: 2 x Laser battery  
DEFENCES: Reflective hull

The Mark 6 Exploration ship does not quite fall within the standard rules of ship design for the STAR FRONTIERS game.

The Sarafand class carries an extra laser battery without penalty because it is built to military, rather than civilian, specifications.

The deck plans also show that a great deal of internal space is devoted to special compartments for fuel storage. This is because starships carry a great deal of fuel within the hull in the TRAVELLER game. Furthermore, the engines are built directly into the hull but they are heavily shielded and can be jettisoned in an emergency. The crew is not exposed to an increased level of radiation.

Referees may also notice that the Survey Modules carry out many of the functions performed by landing drones (Knight Hawks Campaign Book p22). Union pressures have forced the Cartographical Service to maintain its fleet of Mark 6 Exploration Ships, although the Marks 7 & 8 do exist (and are equipped with advanced automated landing drones).

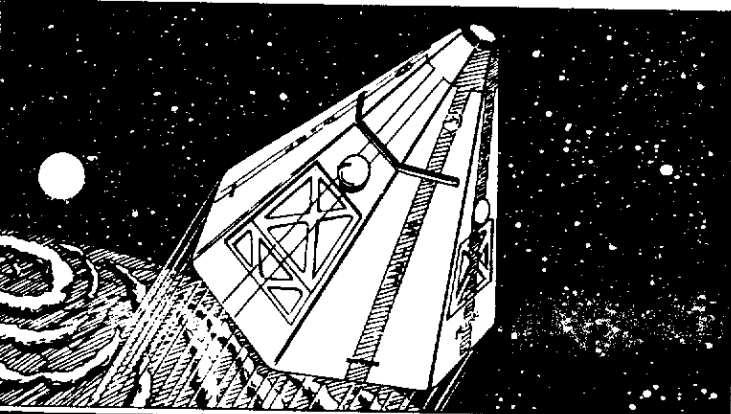

## 2. The Penicillin Man

### Players' Data

#### 00-66-74 Post Urban Collapse

After a drawn out Second World War, lack of co-operation between the victorious Allies, and the apathy of the vanquished, brought about a slow climb from economic ruin. America gained control of the Middle Eastern oil producing countries — and was on the road to recovery — when the Russian Revolutionary State declared war to 'liberate' the oil nations. Drawn into the Oil War which lasted until 1959, Europe expected aid and an oil share from America when the oil states were divide between the two main aggressors, but received neither. Rioting, anarchy and the collapse of centralized government followed.

Europe has been a wasteland for the last ten years. The remaining population returned to a primitive feudal system, content to serve the Petrol Barons in return for protection from roving bandit gangs. The extent of Disruptor influence on this parallel is unclear.

Monkton's Pawn on this parallel is 'Snorty' Hargreaves, a dealer in drugs and medical supplies. Last reported location: the ruins of London.

### Games Master's Information

Again, access to a copy of a London A-Z or similar is useful in running this section of the adventure, although the GM should remember that most of the city is in ruins. The cover picture (of the ruins of Tower Bridge) on this issue of IMAGINE magazine gives an impression of this London — and should be viewed as an aid in visualizing the scene.

The TPV will arrive with a jolt in the dry bed of the River Thames.

During the Oil War, Europe was devastated by chemical weapons. South east England was affected and London lies on the fringe of this area. It is now sparsely inhabited by the survivors of the war — and scavengers who have come down from the North.

The chemical agents — strains of tabon, sarin, soman, arsine and VX — linger on. Throw 8+ each hour (DM +1 per level of *Medical Skill*) to realize that filter masks should be worn and that the atmosphere should be tested. If characters leave the TPV without taking precautions, throw 10+ per hour or fall ill (DM +1 if Endurance 11+). The first symptoms (shortness of breath, trembling — subtract 1D from Strength and Dexterity) will appear after 3 hours plus 15 minutes per point of Endurance. Death will then occur 1D hours later unless a throw of 8+ is made (DM +2 per level of *Medical Skill*). After immediate care the affected character must return to the TPV for continuous care and monitoring by the Auto-Medic. Throw 13+ every two hours to recover (DM +1 cumulative after each four hours of care).

Testing the atmosphere and preparing prophylactic shots — for use in conjunction with filter masks — will take a character with *Medical Skill* four hours. Throw 4+ for each team member for these shots to be effective.

**Encounter 1:** After climbing out of the dry river bed — regardless of which bank — the team will be attacked by a pack of 30 rabid dogs. The dogs will appear from a ruined building some 250m away, and reach the team in waves of 8, 6, 9 and finally 7 dogs.

30 dogs (chaser/carnivores): Weight 30kg; Hits 9/8; Armour None; Weapons Teeth; Reactions A2 F9 S3. Rabies will be contracted from any wound. Throw 6+ to avoid death (DM +2 per level of *Medical Skill*).

**Encounter 2:** The noise of the team fighting the dogs will attract a group of militia from one of London's three Petrol Baron stockades. This group of 10 men (average UPP **894854**, *Shotgun-1*, *Blade-1*) is armed with shotguns (each has 1D+7 cartridges) and blades. They will assume that the team are mercenaries, and try to hire them for protection duties at their settlement — Tomstown — located in the ruins of the Kennington Oval. Even if the team refuse the contract, they will be invited back to the village for trade and drink. The scavengers mean no harm, their offer is an honest one — hopefully the team will have some new stories to tell, medical supplies or mechanical or electrical knowledge to trade.

Should the team refuse the offer to go to Tomstown they may wander London at will. Those encountered will be lone scavengers who will avoid contact with the team — and who know nothing anyway. Eventually the team will encounter either another group of 'militia' who will make a similar offer to the first, or arrive at one of the stockades.

Tomstown is the largest of the palisaded villages/stockades. The others — Fort Windy and Shalve's Palace — are located in St John's Wood and

Fulham. All three are dirty collections of lean-to hovels and rebuilt ruins surrounded by high barricades. Two or three hundred people dwell in each — and half this population requires some form of medical aid. Petrol generators provide a meagre power supply. At each village a militia of 40-60 men, armed with shotguns, rifles and revolvers (all short of ammunition) provide protection and scavenging teams.

The inhabitants of each village have heard of Hargreaves, and several hours of questioning will eventually (throw 9+ each hour, DM +1 per level of *Streetwise* or *Bribery Skill*) find someone who knows his present whereabouts — Casablanca in North Africa — and the fact that he is not expected to return for a year.

The hopelessness of trying to follow him in the time available should be obvious to the team, and again they should be encouraged to leave this parallel as soon as the TPV is ready.

## 3. Cha-no-yu on a Dark Afternoon

### Players' Data

#### 03-02-47 Japanese Empire Variation

Contact and trade with the Portuguese had a remarkable effect on Japan on this parallel. The potential of firearms and Western nautical skills was swiftly learned by the Shogunate. China was invaded and subdued after a century of intermittent, bloody conflict. In the West, the Catholic Church was strong, its influence retarding scientific advancement. Japan had accepted Catholicism, though in 1879 — under Disruptor influence — it returned to its old faith by Imperial decree. The inevitable war between the Japanese and Catholic Empires ended in 1902, and the Japanese Emperor took the title Lord of All the World. The war had seen fantastic advances in Japanese science and industry, again thought to be Disruptor influenced. These advances have continued through to the 1980s.

Industry is now centred in Europe, Russia and America. Although surrounded by Imperial troops, Japan and China have become two vast gardens, where the Japanese — First Class Citizens all — enjoy the fruits of their conquests. Europeans have been designated Third Class Citizens — an improvement on their former status as slaves — since the Humane Reforms of 1943. Indians and Africans, together with some Arabs, are Second Class Citizenry.

In this Japanese World, Monkton's pawn is Ono no Komachi, the Emperor's Geisha. Ono lives in regal luxury in a private house set on an island in the ornamental lake of Nhamaskha Palace, the Imperial residence.

### Games Master's Information

The TPV will arrive in the cellar in London held by a small group of ZeroZero agents, led by Amanda Lewis, a railway labourer. The team will be provided with identification — as Izumo Kusabgi, dealer in Fine Art, and his personal retinue. Bernadette and Boston will be classified as secretaries; other members of the team as servants and bodyguards. An aircraft (which will be waiting at London Airport), and associated documentation, will be provided for the 14-hour flight to Japan, along with sufficient money to maintain Izumo's facade — the equivalent of Cr. 10,000. A facsimile of the Hokusai painting is aboard the plane.

Any Imperial Police involvement with a Third Class Citizen unaccompanied by his superiors will result in automatic detention, unless proof of legal purpose and identity can be produced. In Japan itself, no Third Class Citizen may appear unaccompanied in a public place, no matter what the reason.

The team should be told all of the above, and that the Emperor is not in residence at the Nhamaskha Palace, so it is open for guided tours. Ono no Komachi is in residence.

38 miles from Yokohama City, the Palace is set on an artificial hill next to the Imperial Communications Centre (ICC) — the only normal public access route to the Palace. The flawless gardens are open to the public, and visitors are unescorted, but cameras and patrols make it certain that anyone leaving the marked paths will be swiftly apprehended. The Palace buildings (except the Geisha's house) are also open to visitors — except Third Class Citizens — in escorted groups who are issued ID badges at the ICC Reception Centre.

The lake is purely ornamental, filled by a pumping station beneath the ICC, and quite deep enough for the skiffs which are on it. The bridges are made of wood, supported by stone piers, and the one to the Geisha's island has an electrified gate. It is watched by cameras set at both ends.

A computer-controlled subway runs from the ICC sub-cellar station to the palace buildings — with a branch line to the Geisha's island. The main line back to Yokohama has a service road running beside it. Carriages are routed to the Geisha's island by select officials and her personal retinue — or by computer command. This command can come from any ICC terminal (throw 9+ to defeat the computer's security systems, DM +1 per level of *Computer Skill*). Access to ICC terminals is fully denied to non-Japanese.

Descending from the hilltop, an access road is provided for wheeled vehicles. A gatehouse with a permanent detachment of 15 police officers prevents unauthorised entry. Anyone arriving at the gate without adequate identification and purpose will be detained.

Security is very intense. About 300 police (armed with a variety of swords, automatic pistols, rifles and SMGs) are responsible for patrolling the palace grounds, its buildings and the ICC. Camera surveillance of all main corridors, each subway station and all public areas is maintained.

Surrounded by a wall surmounted by electrified wire, Ono no Komachi's island is not ICC's responsibility. Security is handled by the Geisha's six personal guards. Security cameras watch the gardens, the lake, the bridge, the subway station lift and stairs. One guard will be in the Security Room at all times — except during the interview detailed below. This guard will also have access to the arms locker in which there are four additional sub-machine guns, two revolvers, ammunition for all the firearms in the house, and three swords. The other guards will be spread throughout the house, as will a variety of other staff (maids, cooks and a helicopter pilot), or in the garden.

The small central lagoon has a low jetty with a pair of four-man skiffs tied to it. The helicopter on the landing pad is capable of carrying eight, including the pilot. Bernadette may attempt to fly it (throw 5+ to avoid an accident, with a DM of -3).

Gunfire on the island will not attract attention — the guards often have target practice — but explosions (from Mycroft's launcher) will. The helicopter does not require any clearance to take off, and anyone using the skiffs will not be challenged if they land near a marked path.

In spite of the security around her, Ono no Komachi's weakness as a collector of rare Japanese art will provide the team with access to her. Her private collection is reckoned to be second only to that of the Emperor. To exploit this weakness, the team has a Hokusai painting that was never painted on this parallel. If the team opt for this method of contact, the facsimile and a letter of introduction can be handed to ICC officials or be posted to her. ICC will bring it to Ono's attention that day, and an interview will be arranged for the following afternoon. If posted it will take an extra day before an interview is arranged.

Ono — thanks to her Disruptor contacts — will recognize the painting as extra-parallel in origin. She will immediately contact Monkton using the TPC in her house, and he will order her to capture at least two of the team, and eliminate the rest.

On the afternoon of the interview, all her staff, except the guards, will be sent to the main Palace. The guards will be stationed in rooms around the main lounge, where Ono will meet Izumo in his persona as an art dealer. Izumo and his accompanying retinue will be escorted to the house by a regular ICC official and two policemen from the ICC building. As specified in the **Equipment Section**, the TPC will be set to generate psychic 'white noise'.

Ono will be disguised as her own maid (any character specifically examining her must throw 8+ to see through this disguise, DM +1 if Education 10+, or +2 if Izumo). After the ICC personnel have departed, she will ask the team to wait for 'her mistress' and offer tea to all the members of the team — at this point astute players may realize that something is wrong given the nature of this Japanese society.

The tea is drugged (throw 9+ or fall unconscious in two combat rounds -30 seconds — plus five seconds per point of Endurance, DM +1 if Endurance 10+). When the first victim passes out, Ono will draw an automatic pistol from her clothing and call for the guards. She will then order the team to surrender — an order they do not have to obey. Anyone drugged will be kept sedated until Monkton returns to this parallel if the Geisha and her guards win. The rest will be killed. The team will have failed.

**Ono no Komachi**

UPP 7C6BAB

*Admin-1, Bribery-1, Computer-2, Medical-1, Wheeled Vehicle-1, Unarmed Combat-1, Sword-1, Automatic Pistol-2.*

Languages spoken: Japanese

IMAGINE magazine, May 1984

## 03-02-47 Japanese Empire

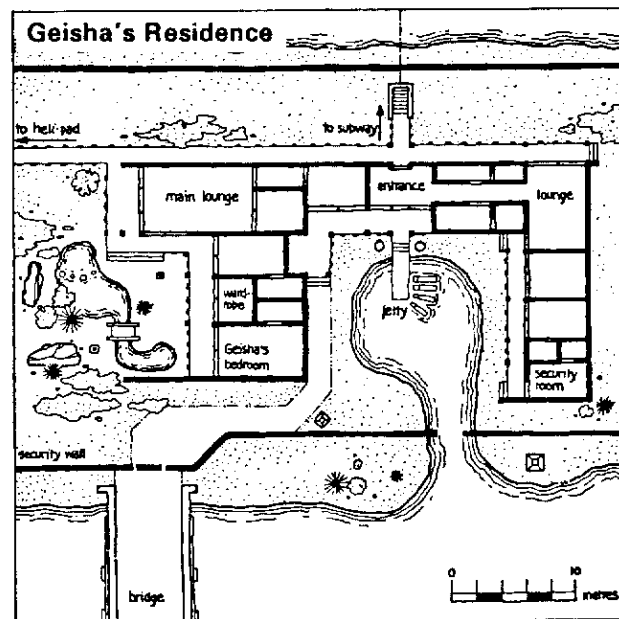
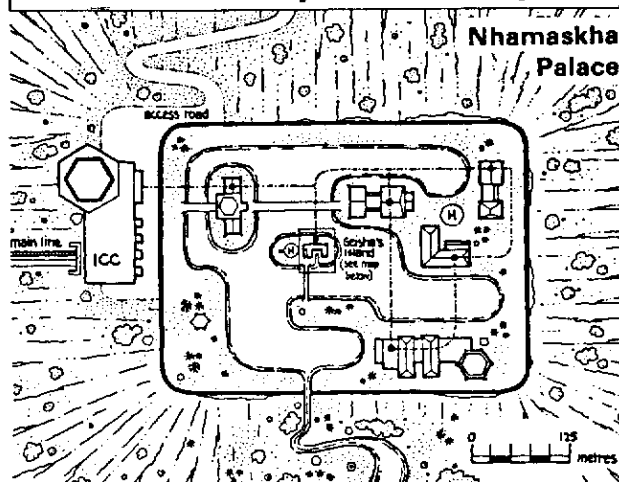

- Subway with station
- main line to Yokohama
- trees and shrubs
- shoreline of lake
- wall with door
- palace building
- movable screens
- heli-pad

**Six Guards**

Average UPP 7A8768

*Revolver-1, SMG-1, Unarmed Combat-2.*

All are armed with a submachine gun and a revolver.

Ono's TPC is hidden in her wardrobe area and booby trapped (throw 9+ to notice this, DM +1 per level of *Computer* or *Electronics Skill* and 10+ to disarm the booby trap, DMs +1 per level of *Computer Skill*, +1 if Dexterity 8+, +3 if Vladek is attempting to do so). If the TPC is used without the trap being detected and disarmed, a small atomic device located under the house will be detonated by radio signal, killing everyone within a one mile radius.

The TPC is set to communicate with Parallel 00-73-87: London. This, and any data about Monkton the team can extract from Ono are the only clues they should normally be given about the Disruptor Knight's whereabouts. If the players are really stuck at this point, the GM can allow a character to find a religious broadsheet from St Paul's Cathedral on 00-73-87. If this hint fails the GM should tell the team that Monkton's name is pencilled on it.

The team will be able to use this TPC to contact ZeroZero. From here, or a London terminal that the ZeroZero agents operate, the team will receive the reprogramming needed to take their TPV to 00-73-87, a picture of Harry Fairfax (a ZeroZero agent), and how to find him at the Hilton Tavern in 'the Maze'.

## The Other Parallels

And had the Valkyrie Team Beta mission gone as intended...

The fourth and fifth parallels pre-programmed into the TPV should not be visited by the team at all. However, the following information is available to the players and should be given to them in a similar fashion to the Players' Data on the first three parallels.

### 01-23-48 EEC/British Empire Variation

Germany, her recovery and re-unification aided after the Second World War by the Disruptors, is the dominant power within the European Economic Community. Still the major world colonial power, Great Britain is being undermined by Germany through massive support in terms of cash aid to Republican elements within Ireland — all carefully channelled through North American Irish organisations.

ZeroZero has a large influence on this parallel, and WOTAN agents can expect little aid.

Monkton's Pawn on 01-23-48 is, as might be expected, heavily involved in the Irish situation. 'Captain' Thomas J Fitzpatrick is an armaments procurer and, although his last address is known to be defunct, he is still believed to be in Ulster.

### 00-73-11 Catholic Empire Variation

Rising to true European dominance in the late 16th century, Rome under the New Caesars achieved an artistic and military renaissance. By the end of the 17th Century this had changed to a tyranny that the Holy Roman Church deposed in 1822.

The Catholic Church proved, however, to be a sterner master than any of the New Caesars. Its first acts weakened and — finally — removed the nobility. This policy of 'all men equal under God' was supported by the peasantry — and some of the nobility who readily surrendered their lands in exchange for Church positions. 160 years of world theocracy have been the result, with science reserved by and for the Church — few of the benefits ever reach the common people.

Monkton's Pawn is Father Keith Fleming, the parish priest at St Mary's Church, Preston in Britannia (Northern England).

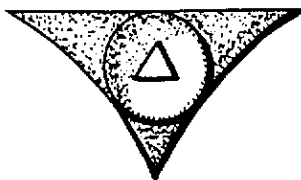

## The Entropy Effect

The physical and psychic manifestations of the FireFrost Activation will become more and more noticeable as time passes in the adventure. As specified in the Briefing, the team must find the location of FireFrost and return with the information before the Entropy Effect reaches an unacceptable — and irreversible — level.

In game terms the Entropy Effect will reach this point after 13 days. Up to that point there is a finite chance that some effect of FireFrost will manifest itself on the same parallel as the Valkyrie Team Beta.

There are three types of manifestation which will affect the team: TPV malfunction, strange 'happenings' and psychic disturbances. The GM should roll once per day for each type of effect on the following table to see whether that effect occurs, and then see the appropriate notes for the nature of the Entropy Effect.

Day	1	2	3	4	5	6	7	8	9	10	11	12
Throw	12+	11+	10+	9+	9+	8+	8+	7+	7+	6+	6+	5+

If an effect is indicated the GM should decide at what time of the day it occurs.

**TPV malfunction:** A malfunction in one of the TPV's systems will occur. A DM of -5 is applied to the initial throw. A roll of 9+ must be made to repair the throw in 8 hours, DMs +1 per level of *Electronics* and *Computer Skill* applied, -1 if a second Entropy Effect roll indicates another effect.

**Psychic Disturbances:** Any non-Disruptor psionically talented character will lose 1D-3 psionic strength points.

## 4. The Maze

### Players' Data

#### 00-73-87 Puritan Protectorate Variation

The Protectorate of the Cromwells — controlled by the Disruptors — is now facing action by Royalist forces, backed in turn by ZeroZero. Strict curfews and executions of suspected Royalist terrorists are only two of the policies of General Standish and the Supreme Puritan Guard.

These policies are not — indeed could not be — imposed on the area within the London Wall known as 'the Maze'. It is a vast no-go area where all the misfits and undesirables in the Protectorate — mainly the London mob of cut-throats, beggars, wastrels, rakes, pimps, prostitutes and artists — and the Royalist rebels live. The Maze is the only place where taverns, theatres, brothels — and Roman Catholic churches — can be found.

### Games Master's Information

The TPV will arrive (amid a thunderclap) eight kilometres west of London, some fifty metres north of the Thames — and six metres above ground level. The explosive arrival and resulting fall will render characters unconscious unless a throw of Endurance or less on 2D is made. On landing, a huge rock pierces the hull and embeds itself in the central generator.

The computer will indicate that the TPV will implode within 5-8 minutes — it will actually happen in 6 minutes (24 combat rounds) and anyone or anything in the TPV will be destroyed. It takes 6 combat rounds for two people to carry an unconscious character clear (18 combat rounds for one person). Removing weaponry and other equipment takes 1 combat round for small items (ie items which can be roughly defined as a 'handful' — vibrobeamers, binoculars, filter masks etc). Larger items such as medical kits, suits of cloth armour, Mycroft's grenade launcher, take 2 rounds to remove.

The TPV has arrived in a pasture. From the position of the sun it appears to be late afternoon. A short distance downstream is a wooden jetty with a rowing boat (big enough for ten people) moored to it — and a small farmhouse is visible about 200m away. It is deserted.

Taking the boat is the only available method of reaching Fairfax quickly. It will take three hours to reach London and as it will be dark by this time, the team will be breaking curfew. This is no great hazard until the boat reaches the Tower of London. At this point the river is swept by searchlights from the Tower (throw 5+ to avoid the beams), and if the boat is spotted a machine gun will open fire — without any real intent to hit. Two motorized launches will intercept the boat if it is still illuminated by the searchlights (throw 10+ to move the boat out of the light). Each

**Strange 'happenings':** The GM should roll once on the following table. DMs: -1 on Days 1, 2 or 3; +1 on days 10, 11 or 12.

**0:** An NPC approaches the party and informs them he is in possession of an atom bomb (or similar), and would they like to see it. The NPC is, of course, certifiably insane.

**1:** A sudden fall of hailstones appears out of a clear blue sky. Roll 4+ to avoid injury (1D-3 wounds). Many of the hailstones are red in colour.

**2:** Unseasonable weather — the GM should determine what are the most unlikely weather conditions for the parallel.

**3:** A rain of frogs, fish, mice or snails occurs. The GM should determine whether this causes damage or danger to the team.

**4:** Aurora Borealis display — radios and other short-range communicators become inoperable. On a throw of 9+ any computer will malfunction.

**5:** Earth Tremor — any character who does not throw 7+ will be thrown to the ground and take 1D wounds. Buildings will suffer minor superficial damage.

**6:** The pull of gravity is increased or decreased by 10% for one hour. At the end of that period gravity returns to normal.

**7:** Spontaneous Human Combustion — an NPC within sight of the players will burst into flames and be reduced to a small pile of ash within two combat rounds. The player characters will be unable to help.

## Weapons

**Vibro-beamer (1400 grams; TL 12):** The basic weapon of ZeroZero agents, the vibro-beamer fires a burst of concentrated ultrasonic sound that shakes the target to pieces. The weapon is the same size and general shape as an automatic pistol with a fitted silencer — 300mm in total length. The integral magazine capacity is 20 shots, and this can be recharged from a suitable power source in 10 minutes (40 combat rounds).



**Mini-RAM Grenade Launcher (4500 grams loaded; TL9):** Similar in appearance, size and weight to a shotgun with a folding stock, this 20mm grenade launcher fires one shot for each pull of the trigger. A six round magazine is inserted under the barrel, and the grenade load may be tailored to suit the user's requirements — eg flechette, flechette, HE, HE, HEAP, flechette. Magazines are 350mm long and 25mm in diameter and weigh 750 grams (individual grenades weigh 125 grams). A sling is provided to assist carrying, although von Neuman normally carries his in a carpetbag.

## Weapons Matrix

Attacker's Weapon	Defender's Armour							Defender's Range					Wound Inflicted	Dexterity Requirements							
	Nothing	Jack	Mesh	Cloth	Reflec	Ablat	Combat	Close	Short	Med	Long	V Long		Req	Lvl	Dex	DM	Advn	Lvl	Dex	DM
Vibro-beamer	+4	+4	+2	+1	+4	+4	-2	0	+3	+1	-1	no	4D	7	-2	10	+2				
Mini-RAM Grenade Launcher														8	-3	11	+1				
HE	+4	+4	+2	+1	+4	+4	-3	no	no	+2	+1	-6	5D								
Flechette	+6	+6	+2	-3	+6	+3	-7	no	no	+2	+1	-6	2D								
HEAP	+2	+2	+1	+2	+2	+2	-1	no	no	+1	0	-5	5D								

boat is manned by five men armed with shotguns. If the team is captured it will be held indefinitely in the Tower of London, awaiting execution. The GM should determine the chances of escape before the original 13-day ZeroZero time limit expires.

Once past the Tower it will be easy to dock under London Bridge and enter the Maze — roughly the same area as the financial centre of London today. The Maze is similar to the slum areas of the 15th Century (this London never had a Great Fire), and is in a very delapidated condition. The streets are little better than open sewers, overhung by the upper storeys of buildings. Street gangs roam at will, bullying the inhabitants for landlords, pimps and pleasure. However, the growing Royalist presence (and uncertainty as to its future) mean that most 'neutral' Maze dwellers are keeping out of sight and trouble.

Harry Fairfax is waiting in the Hilton Tavern, a genial den. When approached he will leave his game of dice and lead the players to the rug.

Fairfax will give them directions to a room Monkton has rented over a small drapers on Threadneedle Street. The room is used for meetings of the 'St Paul's Theatre Group' and occasionally as a place to sleep. If he is not in his room, Monkton could be anywhere. Most of the people who try to follow him fail or end up dead. Fairfax does not know whether Monkton has a permanent base or where it might be.

Monkton always carries a shotgun — and never misses with it. Fairfax knows of two cases where men died at Monkton's hands — both were big men, and had survived shotgun wounds before. Fairfax suspects that Monkton has tampered with the gun — or that he is a sorcerer. Beyond this Fairfax will be unable to help them.

Fairfax was being watched by three of Monkton's men, who will leave to tell their master that the team has arrived (if Monkton was warned by Ono no Komachi) or that Fairfax has met people of obviously extraparallel origin.

Monkton will immediately leave his room in Threadneedle Street and go to the Merry Jackdaw — a 'gentleman's club' on the corner of Cheapside and Bread Street. He will order two men to remove all evidence of his presence — and then lose themselves.

When the team arrive the room will be locked and unoccupied. The owner of the draper's shop, John Haselrig, was disturbed by the sounds of Monkton's hurried departure and got up to complain. Brushed aside by Monkton's men, he still wants to complain to someone. While moaning about 'stage players' and their lack of consideration for others, he will tell the team that they have gone. He will let the team into the room on a throw of 8+ (DM +1 per level of *Bribery Skill*, +1 if Strength 9+), and on another throw of 4+ (same DMs) he will mention that one of the men said that he 'wished he could go to the Merry Jack... as well'.

The room contains a bed, a table, three chairs and a wardrobe. A search will reveal three shotgun cartridges (modified as described in the *Disruptors*) and a religious broadsheet from St Paul's Cathedral. Anyone examining the cartridges may notice the tampering (throw 7+, DMs +1 per level of *Shotgun Skill*). A character with *Medical Skill* (and a medical kit) will be able to synthesize prophylactic shots for the nerve poison on a throw of 8+ (DM +1 per level of *Medical Skill*).

## 00-73-87 The Maze

### The Merry Jackdaw

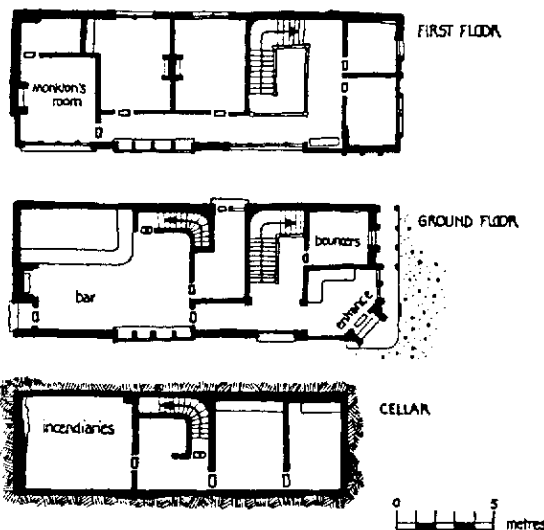

### St Paul's

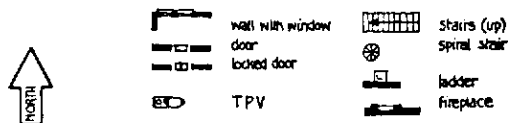
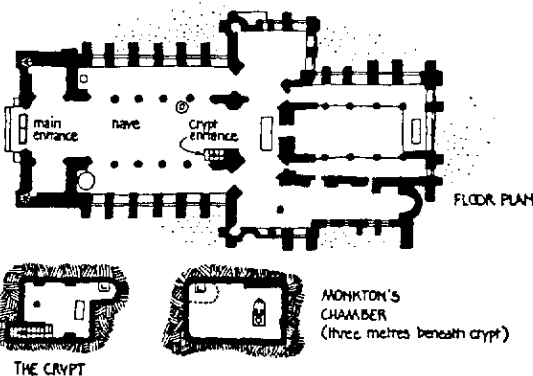

## KEY

Questioning Maze-dwellers may (throw 6+, DM +1 per level of *Streetwise Skill*, repeat the throw every five minutes) reveal that the 'Merry Jack' is probably the Merry Jackdaw, and where it is located.

The Merry Jackdaw Gentleman's Club is staffed by three barmen (average UPP **778622**, *Brawling-1*, *Shotgun-1*), two of whom spend their time playing cards in the back room; and five girls. A single shotgun is kept beneath the bar. Apart from Monkton and the employees, there are three 'gentlemen' being entertained in the bar.

Nobody (other than Monkton) knows that the Merry Jackdaw is also a huge incendiary mine, to be exploded (like others at strategic locations in the Maze) when the Royalist rising starts, starting a Fire of London. The door to the cellar, and the incendiaries, is locked — and the staff do not have the key.

As the team enter the barman will greet them in a friendly fashion, although he will realize that they are not here to avail themselves of the Jackdaw's facilities. He will tell them which room Monkton is in — as he is more than certain that Monkton can look after himself — and will



## The STAR FRONTIERS® Game

Although the STAR FRONTIERS® and Traveller games might seem very similar, there are deep-rooted differences. This section is intended to be a guide — and that is all it can be — for GMs who want to run the *Fire Opal of Set* as a STAR FRONTIERS module.

Characters in Traveller are defined by Strength, Dexterity, Endurance, Intelligence, Education and Social Standing on a scale of 1-15 for each Characteristic. These are written down in a shorthand form called the Universal Personality Profile (UPP) in the order above, and in hexadecimal numbers (0-9 mean exactly that, A = 10, B = 11, C = 12 etc). While none of these Characteristics conforms exactly to Abilities, as a rough guide 1 point of a Traveller Characteristic equals  $6\frac{2}{3}$  points in a corresponding Ability in the STAR FRONTIERS game.

Skills in the two games are used very differently. In the module various mentions of 'throw 7+...' occur, with 'DM +1 per...' immediately afterwards. The '7+' part is the number (or more) that must be thrown on 2d6 for something to happen (or not happen!). Traveller uses only 6-sided dice. The 'DM' in this case stands for 'Die Modifier' — a number added to or subtracted from the dice throw. In most cases look at the context in which the skill is being used and then try to find the closest subskill in the STAR FRONTIERS rules. Note that some skills (Admin, Streetwise, Wheeled Vehicle etc) have no direct counterparts at all.

Equipment is, in many ways, the easiest section to deal with. Look at descriptions and choose the nearest equivalent from the existing equipment lists. For example, the vibro-beamer can be seen as a pistol-sized Sonic Disruptor, with a maximum range of 50m or so.

Psonics are a problem. Until the official rules appear (if they ever do), a 'psionic' character in the STAR FRONTIERS game should make an Ability Check based on the average of Stamina and Intuition, to see if the psionic activity succeeds — but guard against letting psionic characters do anything by willpower alone!

Above all, go for the correct 'feel' and don't worry too much about the numbers — after all, it is supposed to be fun!

casually mention that 'John has his shotgun'. He will also warn the team not to include the other customers or any of his girls in their private quarrels.

Monkton (see the **Disruptors**) arrived alone lugging a heavy carpetbag, and went upstairs with a girl. He has drugged her and will use her body as a shield (treat as the equivalent of Mesh) while he lies, stripped to the waist, in the bed. Under the bedclothes is his shotgun, and between his feet is a grenade with a four minute fuse. The pin has been taken out, but the lever is held in place by Monkton's feet. Monkton believes the fight will be over (one way or another) in four minutes — the grenade is his way of striking back from the grave.

His normally brown eyes have been turned startlingly bright blue by a pair of contact lenses. The location of FireFrost — which the team has been seeking — is encoded upon the right contact lens.

Monkton's carpetbag contains spare shells for his shotgun, a medical kit, a set of priest's robes and a set of large keys for the crypt beneath St Paul's — the faded tag has the word 'Crypt' upon it.

On Monkton's death his TPC 'bleeper' will summon a squad of Rooks to destroy his TPC and TPV — stored in the crypt of St Paul's Cathedral. The team should have realised that Monkton's TPV or TPC represent their only hope of contacting ZeroZero and passing the location of FireFrost to WOTAN. They should also have sufficient clues to the location of Monkton's equipment — the robes, religious broadsheets and keyring.

As an extra hindrance to the party, Monkton's grenade or a panic below during any fighting (or some such contrivance by the GM) will cause the Merry Jackdaw to catch fire. 60 combat rounds later (15 minutes) the incendiary mine below it will detonate, causing a latter-day Fire of London. If the team still have not realized that they should be heading for the Cathedral, descriptions of the Fire's spread — preternaturally aided by the Entropy Effect — and panic stricken Maze-dwellers heading towards the only obvious point of safety — the Cathedral — should guide them in the right direction.

The Cathedral is untouched by the fire, and crowded with worshippers seeking salvation from the fire. As the team reach the main entrance the Rooks (two teams — see the **Disruptors**) summoned by Monkton's implant will appear on the steps, surrounded by a pyramid constructed of tubular black material that has an oily sheen to it. The near-mindless Rooks will dismantle their TPV (usable only by them), clipping the sections to their armour. During this time, the native Londoners will be panicking — as their appeals to God seem to have resulted in the appearance of these demonic beings.

The Rooks will enter the Cathedral after clearing the steps and entrance by firing randomly into the crowd. Both teams will proceed down the Nave, firing down the central aisle to move the crowd, to the crypt entrance. One team will take up station here and continue to fire at the crowd, the other team will descend the steps to secure the crypt area.

Once the crypt is secured — or if resisted — the group at the top of the stairs will descend into the crypt and from there into Monkton's chamber, cut into the foundations with a laser. Once there, the surviving Rooks, once opposition is dealt with, will surround Monkton's TPV and TPC and detonate their internal self-destruct devices, effectively destroying their objective. Any character in the chamber when this happens will take 12D in damage.

The Rooks will only attack team members if they attack first or enter the crypt. In both cases, the leaders will attempt to 'register' their team's fire. The random firing by the Rooks to panic the crowd will not affect the team members if they remain calm and under cover.

If the team can prevent the Rooks from destroying Monkton's TPV and/or TPC they will have no trouble in contacting ZeroZero and passing the location of FireFrost to WOTAN.

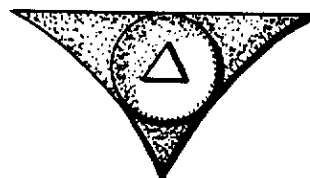

## Credits

**Original concept and plot:** Bryan Talbot and James Brunton  
**Development:** Mike Brunton (no relation), Jim Bambra and Paul Cockburn  
**Art:** Bryan Talbot  
**Cartography:** Paul Ruiz