

# BATTLETECH<sup>®</sup> MASTER RULES



FASA  
CORPORATION

# BATTLETECH<sup>®</sup> MASTER RULES



FASA  
CORPORATION

# **BATTLETECH<sup>®</sup>** **MASTER RULES**



**FASA CORPORATION**

# BATTLETECH MASTER RULES

## TABLE OF CONTENTS

<b>INTRODUCTION</b>	<b>5</b>	<b>Pavement Movement</b>	<b>20</b>	Physical Attacks	
<b>BattleTech Master Rules</b>	<b>5</b>	Bridge Movement	<b>21</b>	by Prone BattleMechs	<b>44</b>
Level Two BattleTech	<b>6</b>	Skidding	<b>21</b>	Physical Attacks	
Reader Response	<b>6</b>	<b>Piloting Skill Rolls</b>	<b>22</b>	Against Prone BattleMechs	<b>44</b>
<b>COMPONENTS</b>	<b>7</b>	Making Piloting Skill Rolls	<b>22</b>	<b>Unit Displacement</b>	<b>44</b>
<b>Units</b>	<b>7</b>	Falling	<b>22</b>	Accidental Falls from Above	<b>45</b>
BattleMechs	<b>7</b>	<b>COMBAT</b>	<b>25</b>	Domino Effect	<b>46</b>
Vehicles	<b>8</b>	<b>Attack Declaration</b>	<b>25</b>	<b>HEAT</b>	<b>46</b>
Infantry Units	<b>9</b>	Torso Twist/Turret Rotation	<b>25</b>	<b>Heat Points</b>	<b>46</b>
<b>Record Sheets</b>	<b>9</b>	<b>Line of Sight</b>	<b>25</b>	Building Up Heat	<b>46</b>
BattleMech Record Sheet	<b>9</b>	Elevation	<b>25</b>	Recording Heat Buildup	<b>47</b>
Vehicle Record Sheet	<b>10</b>	Intervening Terrain	<b>25</b>	<b>Effects of Heat</b>	<b>47</b>
Infantry Record Sheet	<b>10</b>	Partial Cover	<b>26</b>	Movement Effects	<b>47</b>
Battle Armor Record Sheet	<b>10</b>	Water Hexes	<b>27</b>	Weapon Attack Effects	<b>47</b>
Infantry Record Sheet	<b>10</b>	<b>WEAPON ATTACKS</b>	<b>27</b>	Shutdown Effects	<b>47</b>
<b>Mapsheets</b>	<b>10</b>	Ammunition Expenditure	<b>27</b>	Ammunition Effects	<b>48</b>
Clear	<b>11</b>	<b>Firing Arcs</b>	<b>27</b>	MechWarrior Effects	<b>48</b>
Light Woods	<b>11</b>	Forward Arc	<b>28</b>	<b>BUILDINGS</b>	<b>49</b>
Heavy Woods	<b>11</b>	Left Side Arc	<b>28</b>	<b>Building Types</b>	<b>49</b>
Rough	<b>11</b>	Right Side Arc	<b>28</b>	Construction Factor	<b>49</b>
Water	<b>11</b>	Rear Arc	<b>28</b>	Building Elevation	<b>50</b>
Pavement	<b>11</b>	Rotating the Firing Arcs	<b>28</b>	<b>Movement Effects</b>	<b>50</b>
<b>Counters</b>	<b>12</b>	<b>Firing Weapons</b>	<b>28</b>	Entering Buildings	<b>50</b>
Light Buildings	<b>12</b>	Base To-Hit Number	<b>28</b>	<b>Combat Effects</b>	<b>51</b>
Medium Buildings	<b>12</b>	Modified To-Hit Number	<b>29</b>	Attacking Buildings	<b>51</b>
Heavy Buildings	<b>12</b>	To-Hit Modifiers	<b>29</b>	Attacking Units Inside Buildings	<b>51</b>
Hardened Buildings	<b>12</b>	Prone BattleMechs	<b>31</b>	Combat Within Buildings	<b>52</b>
Bridges	<b>12</b>	To-Hit Roll	<b>31</b>	Collapse	<b>52</b>
Rubble	<b>12</b>	Hit Location	<b>31</b>	<b>Basements</b>	<b>52</b>
Fire	<b>12</b>	<b>Damage</b>	<b>33</b>	<b>Gun Emplacements</b>	<b>52</b>
Smoke	<b>12</b>	Recording Damage	<b>33</b>	Turrets	<b>53</b>
<b>Dice</b>	<b>12</b>	Damage Resolution	<b>34</b>	<b>VEHICLES</b>	<b>54</b>
<b>PLAYING THE GAME</b>	<b>13</b>	Transferring Damage	<b>34</b>	<b>Movement</b>	<b>54</b>
<b>Sequence of Play</b>	<b>13</b>	<b>Critical Damage</b>	<b>35</b>	VTOL Movement	<b>54</b>
Initiative Phase	<b>13</b>	BattleMech Critical Hits	<b>35</b>	Naval Movement	<b>56</b>
Movement Phase	<b>13</b>	BattleMech Critical Hit Effects	<b>36</b>	<b>Combat</b>	<b>56</b>
Weapon Attack Phase	<b>13</b>	<b>Destroying A Unit</b>	<b>38</b>	Naval Movement	<b>56</b>
Physical Attack Phase	<b>14</b>	BattleMechs	<b>38</b>	VTOL Movement	<b>57</b>
Heat Phase	<b>14</b>	Vehicles	<b>38</b>	<b>INFANTRY</b>	<b>59</b>
End Phase	<b>14</b>	Infantry	<b>38</b>	<b>Movement</b>	<b>59</b>
Unequal Numbers of Units	<b>14</b>	<b>PHYSICAL ATTACKS</b>	<b>39</b>	Infantry Carriers	<b>59</b>
<b>Warriors</b>	<b>14</b>	<b>Punch Attacks</b>	<b>39</b>	Mechanized Battle Armor	<b>59</b>
Skills	<b>14</b>	<b>Club Attacks</b>	<b>40</b>	<b>Combat</b>	<b>60</b>
Skill Improvement	<b>15</b>	Finding A Club	<b>40</b>	Standard Infantry	<b>60</b>
Damaging a MechWarrior	<b>15</b>	Hatchets and Swords	<b>40</b>	Battle Armor	<b>60</b>
Consciousness Rolls	<b>16</b>	<b>Push Attacks</b>	<b>40</b>	<b>Clan Battle Armor Variants</b>	<b>61</b>
<b>MOVEMENT</b>	<b>17</b>	<b>Kick Attacks</b>	<b>40</b>	Gnome Battle Armor	<b>62</b>
<b>Movement Basics</b>	<b>17</b>	<b>Charge Attacks</b>	<b>41</b>	Salamander Battle Armor	<b>62</b>
Movement Direction	<b>17</b>	Damage	<b>41</b>	<b>Inner Sphere Battle Suits</b>	<b>63</b>
<b>Facing</b>	<b>17</b>	Location After Attack	<b>42</b>	Standard Inner Sphere	
Facing Change	<b>17</b>	Falls	<b>42</b>	Battle Armor	<b>63</b>
<b>Movement Modes</b>	<b>18</b>	<b>Death from Above Attacks</b>	<b>42</b>	Gray Death Light Scout Armor	<b>63</b>
Standing Still	<b>18</b>	Weapon Attack Phase	<b>43</b>	Kage Light Battle Armor]	<b>64</b>
Walking	<b>18</b>	Base To-Hit Number	<b>43</b>	Kanazuchi Assault Battle Armor	<b>64</b>
Running	<b>18</b>	Damage to Target	<b>43</b>	Longinus Battle Armor	<b>65</b>
Jumping	<b>18</b>	Damage to Attacker	<b>43</b>	Achileus Light Battle Armor	<b>65</b>
<b>Movement Actions</b>	<b>18</b>	Location After Attack	<b>43</b>	Infiltrator Stealth Armor	<b>66</b>
Facing Change	<b>19</b>	Falls	<b>44</b>	Sloth Assault Armor	<b>66</b>
Dropping to the Ground	<b>20</b>	<b>Different Elevations</b>	<b>44</b>	<b>SPECIAL CASE RULES</b>	<b>67</b>
Standing Up	<b>20</b>	<b>Prone BattleMechs</b>	<b>44</b>	<b>Anti-BattleMech Infantry</b>	<b>67</b>
<b>Stacking</b>	<b>20</b>			Leg Attacks	<b>67</b>
Accidental Violation	<b>20</b>			Swarm Attacks	<b>67</b>

# TABLE OF CONTENTS

<b>Artillery</b>	<b>68</b>	Clear	<b>91</b>	Heat Sinks	<b>128</b>
Game Setup	<b>68</b>	Hills	<b>91</b>	Laser	<b>128</b>
Targeting	<b>70</b>	Trees	<b>91</b>	Machine Gun	<b>129</b>
Damage	<b>71</b>	Water	<b>91</b>	Missile Launchers	<b>129</b>
Smoke Rounds	<b>71</b>	Roads/Bridges	<b>92</b>	Missile Munitions	<b>130</b>
Onboard Artillery Fire	<b>71</b>	Buildings	<b>92</b>	Narc Missile Beacon	<b>133</b>
Arrow IV Missile Artillery System	<b>71</b>	Rubble	<b>92</b>	Particle Projector Cannon (PPC)	<b>133</b>
<b>BattleMech Lifting Capabilities</b>	<b>72</b>	Rough Ground	<b>92</b>	Sword	<b>133</b>
<b>Cargo Carriers</b>	<b>72</b>	Swamp	<b>92</b>	Target Acquisition Gear (TAG)	<b>134</b>
<b>Clearing Woods</b>	<b>72</b>	Smoke	<b>92</b>	Targeting Computer	<b>134</b>
<b>Dropping Troops</b>	<b>72</b>	<b>Rules Conversions</b>	<b>92</b>	Triple-Strength Myomer	<b>134</b>
Failed Landing Damage	<b>73</b>	Scale	<b>92</b>	XL Engines	<b>134</b>
Failed Landing Location	<b>73</b>	Movement	<b>92</b>	<b>COSTS</b>	<b>136</b>
<b>Dumping Ammunition</b>	<b>73</b>	Stacking	<b>94</b>	Clan Equipment	<b>136</b>
<b>Ejecting</b>	<b>73</b>	Piloting Skill Rolls	<b>94</b>	<b>BattleMech Costs</b>	<b>136</b>
<b>Fire</b>	<b>74</b>	Combat	<b>94</b>	<b>Vehicle Costs</b>	<b>137</b>
Accidental Fires	<b>74</b>	Artillery	<b>96</b>	<b>Infantry Costs</b>	<b>137</b>
Intentional Fires	<b>74</b>	<b>CREATING SCENARIOS</b>	<b>97</b>	<b>BATTLE VALUE SYSTEM</b>	<b>139</b>
Effects of Fire	<b>74</b>	<b>General Rules</b>	<b>97</b>	<b>Calculating BattleMech BV</b>	<b>139</b>
Spreading Fires	<b>75</b>	Number of Players	<b>97</b>	Step 1: Calculate	
Smoke	<b>75</b>	Setup	<b>97</b>	Defensive Battle Rating	<b>139</b>
<b>Flak</b>	<b>75</b>	Movement and Retreat	<b>97</b>	Step 2: Calculate	
Artillery Flak	<b>75</b>	Ending the Game	<b>97</b>	Offensive Battle Rating	<b>140</b>
LB-X Cluster Flak	<b>75</b>	Determining Victory	<b>97</b>	Step 3: Calculate Final BV	
<b>Four-Legged BattleMechs</b>	<b>75</b>	<b>Types of Scenarios</b>	<b>98</b>	<b>Calculating</b>	
<b>Construction</b>	<b>75</b>	Standup Fight	<b>98</b>	<b>Conventional Vehicle BV</b>	<b>141</b>
<b>Movement</b>	<b>75</b>	Hide and Seek	<b>98</b>	Step 1: Calculate	
<b>Combat</b>	<b>77</b>	Hold the Line	<b>98</b>	Defensive Battle Rating	<b>141</b>
<b>Heat</b>	<b>77</b>	Extraction	<b>99</b>	Step 2: Calculate	
<b>Hidden Units</b>	<b>77</b>	Breakthrough	<b>99</b>	Offensive Battle Rating	<b>141</b>
Pointblank Shots		The Chase	<b>100</b>	Step 3: Calculate Final BV	<b>142</b>
from Hidden Units	<b>77</b>	<b>Selecting Mapsheets</b>	<b>100</b>	<b>Infantry</b>	<b>142</b>
<b>Hostile Environments</b>	<b>78</b>	Using the Mapsheet Tables	<b>100</b>	<b>Weapon and</b>	
Extreme Temperatures	<b>78</b>	<b>Unit Generation</b>	<b>102</b>	<b>Equipment Battle Values</b>	<b>142</b>
Ice	<b>78</b>	Force Composition	<b>102</b>	<b>Skill/Experience Level Multipliers</b>	<b>144</b>
High/Low Gravity	<b>78</b>	Assigning 'Mechs	<b>103</b>	<b>RULES CHANGES</b>	<b>146</b>
Swamp	<b>79</b>	Experience Level and Skills	<b>108</b>	<b>Playing the Game</b>	<b>146</b>
Vacuum	<b>79</b>	Finishing Touches	<b>108</b>	<b>Movement</b>	<b>146</b>
<b>Improved Positions</b>	<b>80</b>	<b>CONSTRUCTION</b>	<b>109</b>	<b>Weapon Attacks</b>	<b>146</b>
<b>LRM Indirect Fire</b>	<b>80</b>	<b>BattleMech Construction</b>	<b>109</b>	<b>Physical Attacks</b>	<b>146</b>
<b>Minefields</b>	<b>80</b>	Design the Chassis	<b>109</b>	<b>Heat</b>	<b>147</b>
Conventional Minefields	<b>80</b>	Add Other Equipment	<b>111</b>	<b>Buildings</b>	<b>147</b>
Command-Detonated Minefields	<b>80</b>	<b>Vehicle Construction</b>	<b>118</b>	<b>Vehicles</b>	<b>147</b>
Vibrabomb Minefields	<b>81</b>	Design the Chassis	<b>118</b>	<b>Infantry</b>	<b>147</b>
Clearing Minefields	<b>81</b>	Add Other Equipment	<b>119</b>	<b>Special Case Rules</b>	<b>147</b>
<b>Night Combat</b>	<b>81</b>	<b>Outfitting an OmniMech</b>	<b>120</b>	<b>Construction</b>	<b>148</b>
Searchlights	<b>81</b>	Using Add-on Pods	<b>120</b>	<b>Equipment</b>	<b>148</b>
<b>Reversing Arms</b>	<b>81</b>	<b>EQUIPMENT</b>	<b>122</b>		
<b>Scavenging and Repair</b>	<b>82</b>	<b>Active Probe</b>	<b>122</b>		
Technicians	<b>82</b>	<b>Anti-Missile System</b>	<b>122</b>		
Diagnosis	<b>82</b>	<b>Anti-Personnel Pods</b>	<b>123</b>		
Obtaining Replacement Parts	<b>83</b>	<b>Artemis IV Fire-Control System</b>	<b>123</b>		
Scavenging	<b>84</b>	<b>Artillery Weapons</b>	<b>123</b>		
Repairs and Replacements	<b>85</b>	<b>Autocannon</b>	<b>124</b>		
Customizing and Retrofits	<b>87</b>	<b>C<sup>3</sup> Computer</b>	<b>124</b>		
<b>Underwater Operations</b>	<b>88</b>	<b>Cargo Space</b>	<b>125</b>		
Movement	<b>88</b>	<b>Cellular Ammunition Storage</b>	<b>126</b>		
Line of Sight	<b>88</b>	<b>Equipment (CASE)</b>	<b>126</b>		
Weapon Attacks	<b>88</b>	<b>ECM Suite</b>	<b>126</b>		
Physical Attacks	<b>89</b>	<b>Endo Steel Internal Structure</b>	<b>127</b>		
Hull Integrity	<b>89</b>	<b>Ferro-Fibrous Armor</b>	<b>127</b>		
<b>MINIATURES RULES</b>	<b>90</b>	<b>Flamers</b>	<b>127</b>		
<b>Preparing Miniatures</b>	<b>90</b>	<b>Gauss Rifle</b>	<b>128</b>		
<b>Preparing Terrain</b>	<b>91</b>	<b>Hatchet</b>	<b>128</b>		

## CREDITS

---

### **BattleTech Original Design**

Jordan K. Weisman  
L. Ross Babcock III  
Sam Lewis

### **Project Development**

Bryan Nystul  
*Development Assistance*  
Randall N. Bills

### **Project Editing**

Robert Boyle  
Sharon Turner Mulvihill

### **BattleTech Line Developer**

Bryan Nystul

### **Editorial Staff**

*Editorial Director*  
Donna Ippolito  
*Managing Editor*  
Sharon Turner Mulvihill  
*Associate Editor*  
Diane Piron-Gelman  
*Assistant Editors*  
Robert Boyle  
Tara Gallagher

### **Production Staff**

*Art Director*  
Jim Nelson  
*Cover Illustration*  
Les Dorshied  
*Cover Design*  
John Bridegroom  
*B&W Illustration*  
Earl Geier, Mike Jackson, Scott James, Jeff Laubenstein  
John Paul Lona, Kevin Long, Dave Martin, Chris Moeller  
Jim Nelson, Mike Nielsen, Allen Nunis, Matthew Plog  
Loston Wallace, Matt Wilson  
*Layout*  
Jim Nelson and John Bridegroom  
*Color Illustration*  
Doug Andersen, Les Dorscheid, Clint Langley, Mark Zug  
*Miniature Painting:*  
Jörn Brom  
Hartwig Nieder-Gassel  
*Terrain*  
Michael Immig (city block modules by Ground Zero Games. Other buildings by Snapdragon. Terrain hex bases by GHQ).  
*Photography*  
Michael Immig

*Miniature section design*

John Bridegroom

*Color Section Design*

Fred Hooper

### **Additional Design and Development**

*The following people have been involved in the creation and development of BattleTech rules, either by writing material that was assimilated into the main body of the rules, serving as the BattleTech developer in the past, or otherwise contributing to the game in a major way.*

Samuel B. Baker  
Forest G. Brown  
Chuck Crain  
Chris Hartford  
Clare Hess  
Scott Jenkins  
J. Andrew Keith  
James R. Kellar  
Dale Kemper  
L.R. "Butch" Leeper  
Bryan LiBrandi  
Jim Long  
Jim Musser  
Mike Nystul  
Blaine Pardoe  
Boy F. Petersen Jr.  
Jerry Stenson  
Wm. John Wheeler

### **PLAYTESTERS FOR BATTLETECH MASTER RULES**

L. Ross Babcock III, Randall N. Bills, Loren Coleman, Dan "Flake" Grendell, Chris Hartford, Chris Hussey.  
*Austin Playtest Group:* Frank Crull, Cody Hammock, Greg Hazel, Lewis Helfer, Clint Hill and Robert Houser, Jeff Webb.  
*Group W:* Andrew Bethke, James W. Moorman.  
*MechForce United Kingdom:* Rodney Audley, Chris Bentley, Trevor Cock, Jim Doherty, Dawn Jackson, Steve Jackson, Phil Johansson, Paul "Poly" Meredith, Bob Nicholls, Stephen Pugh, Julian Richards, Gareth Smith, Jos Williams.  
*The Singapore Longshoremen:* John Kielman, Christoffer "Bones" Trossen. *Steel City MechWarriors:* Rich Cencarik, Rich Darr, Scott Jamison.

### **Playtesting of previous editions**

Much as we appreciate and recognize the efforts of those who have gone before us, the list is too extensive to reprint here. Thanks again to all those who have worked to make this game what it is today.

### **Special Thanks To:**

The members and staff of all the MechForce organizations worldwide, for their unending support, and to all the people online who keep us on our toes.

Mike Stackpole, because he didn't get any credit last time (and boy, does he deserve it), for shaping the *BattleTech* universe into its current, convoluted form.

# INTRODUCTION

For almost a thousand years, humans have journeyed into the far reaches of space, colonizing thousands of worlds and forming star-spanning alliances. From these grew the five vast star empires that make up the Inner Sphere.

But the Inner Sphere was divided. Its ruling dynasties warred constantly over colony worlds with valuable resources. These titanic struggles led to the development of BattleMechs: gigantic, humanoid battle machines bristling with lethal weapons. From the twenty-fifth century onward, these walking tanks ruled the battlefields. BattleMechs and their skilled pilots changed combat forever.

As the price of conflict grew, the Inner Sphere tired of war. In 2571, the five ruling Houses joined together in the Star League, a federation led by a First Lord and served by its own army. For nearly two hundred years, the Star League brought the Inner Sphere peace and prosperity.

In 2751, the sudden death of its First Lord left the Star League in the care of a child. Young Richard Cameron ruled in name, but the real power lay with the five Council Lords. Ambitious and distrustful, they plotted against one another, while an evil genius named Stefan Amaris wormed his way into Richard's trusting heart. In 2766, Amaris assassinated Richard and took control of the Star League in a bloody coup d'etat.

The Star League Defense Forces, commanded by the brilliant General Aleksandr Kerensky, refused to accept Amaris's rule. For thirteen years, they fought him in a bitter civil war that was the largest conflict ever fought by humanity, before or since. Kerensky's forces won, but at a terrible price. In the chaos that followed, the Council Lords were each determined to step in as First Lord. Despite the efforts of Kerensky to hold it together, the Star League dissolved in 2781.

Unable to halt the impending conflict, Kerensky appealed to his soldiers to join him in leaving the Inner Sphere. Nearly 80 percent of the Star League army heeded Kerensky's call to build a new Star League somewhere far beyond the explored universe. In 2784, Kerensky and his followers abandoned their homes and headed into uncharted space, presumably never to return.

War followed war in the wake of Kerensky's dramatic departure. For nearly three centuries, the Houses of the Inner Sphere fought in vain for the right to rule the universe. These Succession Wars brought new alliances and cost the Inner Sphere precious, irreplaceable technology. Constantly maneuvering for position, the House Lords assumed that the greatest enemy they would ever face was each other.

They were wrong.

While the Inner Sphere sank into barbarism, Kerensky's followers built a new society in the harsh environs beyond known space. They developed a rigid caste system, designed to produce the ultimate warriors. For nearly three hundred years, the separate castes of Kerensky's Clans were unified by one burning ideal: that when the time was right, they would return home and conquer the Inner Sphere. They would become the "saviors"

of humanity, rebuilding the Star League in their own image. In 3048, the warlords of the Clans decided the time had come to launch their invasion. With their powerful 'Mechs and MechWarriors, they drove straight toward Terra, the birthworld of humanity.

Faced with a common enemy, the states of the Inner Sphere united against the threat. But their trust is fragile, their fledgling alliances fraught with risk. The Clans also vie with each other for the honor of first reaching Terra. But these internal clashes are nothing compared with the all-out war that rages between the Clans and the Houses.

House against House, Clan against Clan, or House against Clan, war is everywhere. As commander of a BattleMech force, you must outshoot, outmaneuver, and outthink your enemy to reign supreme on the battlefield. Your 'Mechs are ready to take the field—are you ready to lead them?

## BATTLETECH MASTER RULES

The *BattleTech Master Rules (BMR)* is the single-source rulebook for people who play *BattleTech*. It is not intended to teach new players the game, but rather to serve as a reference work for people who know the game. The introductory game in the *BattleTech* line is the *BattleTech, Fourth Edition* boxed set. New players should pick up that product before diving into this one. In addition to presenting the game in a reference-work format, the *BMR* introduces many special case rules to the game that inexperienced players might find difficult to absorb all at once.

The *BattleTech Master Rules* is not simply a rehash of the old rules. The book has been carefully reworked from previous editions to clarify confusing or contradictory information, and certain key sections, such as damage resolution, have been broken down into step-by-step procedures to make every rule as clear and concise as possible. The *BMR* also includes additional material to expand and enhance game play. In addition to the rules of *BattleTech*, this book contains an easy-to-use scenario creation system, the Battle Value system for rating units and balancing forces, and rules for translating the hex-based game of *BattleTech* into a tabletop miniatures game.

These rules supersede all previously published rules, including the *BattleTech Manual*, the *BattleTech Compendium*, the *BattleTech Compendium: The Rules of Warfare (BTC:RoW)*, and *BattleTech, Fourth Edition*. This book does contain a number of rules changes from previous editions. Most of the changes included in these rules are the direct result of player letters and calls asking FASA to clarify and tidy up the rules of *BattleTech*. In general, most changes made to the rules consist of rephrasing to clear up any confusion or ambiguities. We at FASA feel confident that these are the most complete, clear and concise rules for *BattleTech* ever presented. For experienced players who do not wish to reread all the rules in order to find what has changed, there is an appendix starting on p. 146 that

# INTRODUCTION

summarizes all of the significant changes to the rules since the *BattleTech Compendium: The Rules of Warfare*.

To play *BattleTech*, players will need dice, maps, and counters or miniatures to represent the BattleMechs and/or vehicles used by each side. For more information about the availability and use of these items, see *Components*, p. 7 of this book.

## LEVEL TWO BATTLETECH

All *BattleTech* rules now carry a Level One, Level Two, or Level Three designation. Level One *BattleTech* rules represent the basic level of play described in *BattleTech, Fourth Edition*, and use the technology available in 3025, including all 'Mechs and weapons described in *Technical Readout 3025*.

Level Two *BattleTech* expands on the Level One rules by adding the advanced technology of the Clans and additional

rules for infantry, vehicles and so on. These rules are those used in most *BattleTech* tournaments and MechForce-level competition. Level Two *BattleTech* is defined by the rules contained in this book and any rules designated as Level Two in any future *BattleTech* publications.

Level Three *BattleTech* play may include any of the optional rules presented in various *BattleTech* products such as *Maximum Tech*, as well as in the various *MechForce* publications worldwide. These rules are always identified as Level Three. Players may use Level Three rules as they see fit. Generally, Level Three rules are not used in tournament play. None of the rules in this book are Level Three.

## READER RESPONSE

We hope this product will help you better enjoy your *BattleTech* game. If you have questions or comments about *BattleTech* or any other FASA product, please write to us at 1100 W. Cermak, Suite B305, Chicago, Illinois, 60608, or send an e-mail to [fasainfo@aol.com](mailto:fasainfo@aol.com). While we do

respond to all mail, we simply do not have the time to indulge in the luxury of writing detailed answers to general questions. To

make it easier for us to answer your questions quickly, provide us with multiple-choice questions or phrase your query so that we can answer either yes or no. Please include a self-addressed, stamped envelope with your letter for our reply.

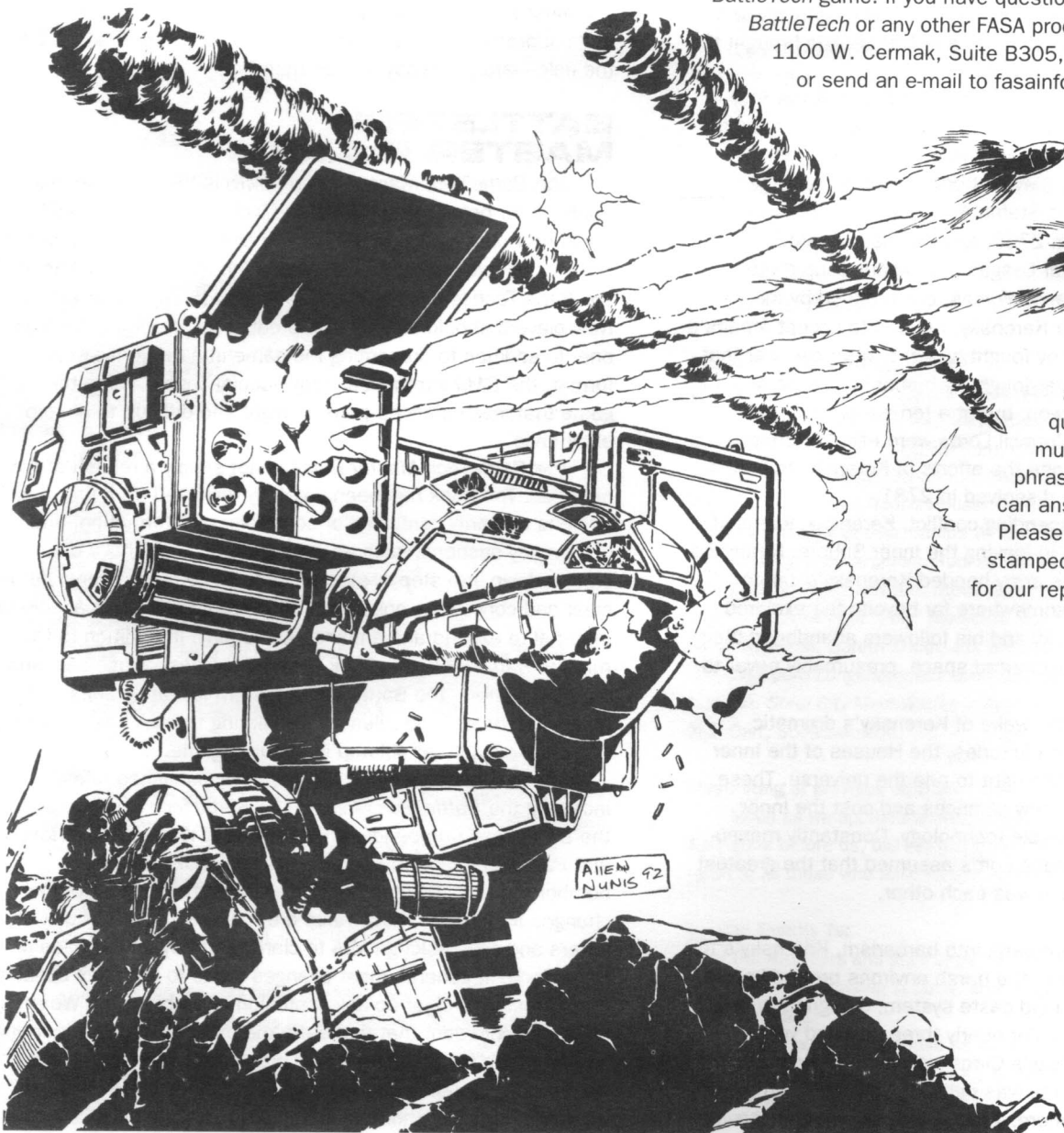

## COMPONENTS

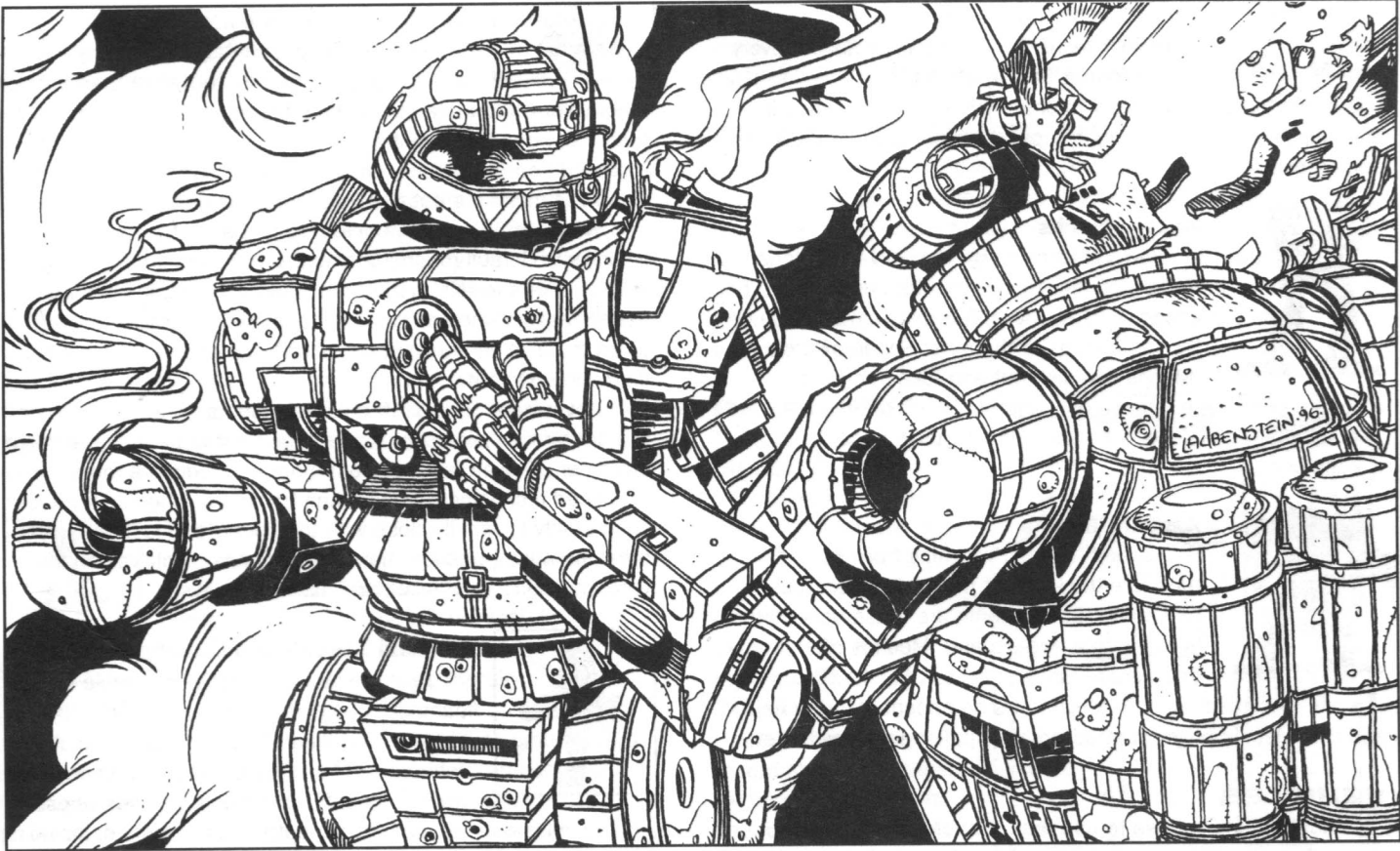

The game of *BattleTech* simulates combat between BattleMechs, vehicles, or infantry units on a variety of terrain. This chapter describes the various combat units that compete on the *BattleTech* battlefield and the various record sheets and maps needed to play the game.

### UNITS

In these rules, the term unit refers to any combat unit—BattleMech, vehicle, unarmored infantry platoon, or battle armor Point or squad. Each unit moves and attacks individually on the map.

During game play, units are best represented by miniatures. A complete line of *BattleTech* miniatures is available from *Ral Partha* (see the color pages later in this book for photos of some of these miniatures). If miniatures are unavailable, players may use counters such as those found in *BattleTech, Fourth Edition* or any other item to represent each unit, as long as it is clear which way each unit is facing at all times.

### BATTLEMECHS

BattleMechs—the most powerful ground-based war machines ever built—dominate the battlefields of the thirty-first century. These huge, humanoid vehicles stand ten to twelve

meters tall and weigh as much as 100 tons. They are faster, more maneuverable, better armored and more heavily armed than any other combat unit. Equipped with particle projector cannons, lasers, rapid-fire autocannons and missiles, these behemoths pack enough firepower to flatten everything but another 'Mech.

Armies of the thirty-first century field two classes of BattleMechs: those used primarily by the Inner Sphere, representing variations of and improvements on the original 'Mech technology, and the modular machines that gave the Clans their initial edge, known as OmniMechs. Both BattleMechs and OmniMechs are classified as Light, Medium, Heavy or Assault.

#### Light 'Mechs

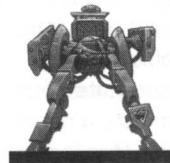

Light 'Mechs range in weight from 20 to 35 tons. On the battlefield, light 'Mechs serve most often in reconnaissance roles. Their above average speed and jump capability make them well-suited to efficiently avoid

heavy fighting while maneuvering to assess enemy troop formations. Despite their many assets, however, light 'Mechs rarely manage to stand against heavier units, even with the advantage of numerical superiority.

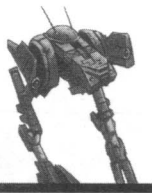

## Medium 'Mechs

The workhorses of the armies of the Inner Sphere, medium BattleMechs range in weight from 40 to 55 tons. On the battlefield, medium 'Mechs form the core of almost every unit or formation. While light 'Mechs scout out

battlefield terrain and enemy forces, medium 'Mechs wade in and slug it out with opposing troops until the heavy and assault units arrive.

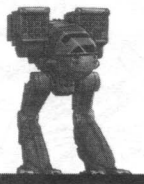

## Heavy 'Mechs

Heavy 'Mechs weigh from 60 to 75 tons. Usually piloted by commanders and experienced MechWarriors, they play a major role on the battlefields of the Inner Sphere. Heavy 'Mechs can dish out and take immense

amounts of damage, and so only another heavy or an assault 'Mech usually can successfully take on a typical heavy BattleMech.

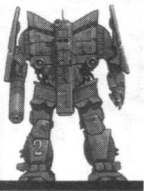

## Assault 'Mechs

Assault 'Mechs, weighing from 80 to 100 tons, are the kings of the thirty-first-century battlefield. So fearsome are these behemoths in battle that one assault 'Mech is often equal to an entire lance of lighter 'Mechs. The pilot

of a well-designed assault 'Mech fears no opponent in the field, and the 'Mech's physical attacks can cripple nearly any target.

## VEHICLES

Most armies choose to use their BattleMech resources sparingly when they can, and so maintain forces of conventional vehicles to serve in low-intensity conflicts and as auxiliaries to BattleMech units. Like BattleMechs, vehicles can also be constructed as modular "OmniVehicles." Vehicles are classified by weight in the same manner as BattleMechs, and also by their type of locomotion.

**Light Vehicles:** Light vehicles weigh anywhere from 5 to 35 tons. Primarily used for reconnaissance, the light vehicle is almost exclusively designed for speed. Though tracked and wheeled light vehicles exist on the battlefield, hovercraft—with their greater speeds—dominate this weight class.

**Medium Vehicles:** Medium vehicles weigh from 40 to 55 tons. Used as skirmishers, medium vehicles are fielded by the various House militaries of the Inner Sphere to harass and pin down an enemy until heavier forces can be brought to bear.

**Heavy Vehicles:** Heavy vehicles range in weight from 60 to 75 tons. Mirroring the medium 'Mech weight class, heavy vehicles are the workhorse vehicle of all Successor State armies. Packing a serious punch, with armor to match, a heavy vehicle can stay in the fight longer than some light 'Mechs.

**Assault Vehicles:** Assault vehicles weigh from 80 to 100 tons. Though they lack the mobility of their 'Mech counterparts, the sheer volume of firepower that an assault vehicle carries can be the downfall of even a heavy 'Mech if the MechWarrior piloting it fails to exercise caution.

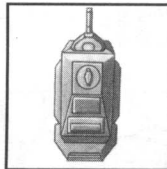

## Ground Vehicles

The Inner Sphere armies of the thirty-first century deploy three types of ground vehicles: tracked, wheeled, and hovercraft.

**Tracked:** Because they move using continuous caterpillar treads, these vehicles are normally referred to as tanks, though the original meaning of this term has been lost in antiquity. Commonly armed with turret-mounted heavy weapons, some of the heaviest vehicles of this class can inflict a great deal of damage, even to a BattleMech.

**Wheeled:** Wheeled vehicles move faster than tracked vehicles while still mounting effective weapons. These vehicles suffer serious terrain restrictions, however, so commanders usually assign wheeled vehicles to relatively open terrain and cities to serve as convoy escorts or fire-support vehicles for dismounted infantry.

**Hovercraft:** Hovercraft are designed for speed and rely on that feature for protection rather than their weak armor and light armament. Hovercraft also cost more and require a more advanced technological base than tracked or wheeled vehicles. Their ability to rapidly close with the enemy and just as rapidly break contact, however, makes these units highly valued for reconnaissance and screening missions.

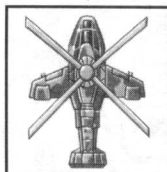

## Vertical Takeoff and Landing (VTOL)

Fast, deadly, and highly vulnerable to damage, VTOLs and their pilots suffer the highest mortality rate of any type of combat vehicle. The term VTOL refers to a variety of vertical takeoff and landing vehicles whose

primary mission is to support the battle on the ground, including conventional rotary-wing craft (helicopters), X-wing "stopped rotors" craft, and tilt-rotor aircraft (the engine mountings rotate in a 90-degree arc). Because of the high torque required for their operation, VTOL rotors cannot be heavily armored and so cannot absorb much combat damage. More VTOLs are destroyed by rotor hits than by any other type of damage.

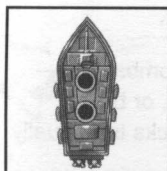

## Naval Vessels

High-tonnage military naval vessels long ago gave way to the superiority of conventional and aerospace fighters. However, small vessels for performing counterinsurgency work and defending underwater command posts still serve a unique and useful purpose.

**Surface Naval Vessels:** As the name implies, this class of vessel operates only on the surface of bodies of water. Surface vessels come in two types: those with a displacement hull, and hydrofoils. Vessels built with a displacement hull represent the cheapest, best protected, and best armed of all the naval vessels, but their conventional rounded hull prevents these vessels from attaining the speed necessary to close quickly with an elusive enemy. Hydrofoils offer speed and punching power that displacement-hulled vessels lack. Featuring wings that lift the vessel's hull out of the water, these naval assets usually patrol coastlines and guerrilla-infested river deltas.

**Submarines:** Technological advances allowed manufacturers to create ever-smaller submarines over the past several centuries, and these underwater vessels still reign supreme in the oceans of most worlds. In their home environment, these expensive and specialized vessels can reasonably expect to defeat an equivalent-weight BattleMech. Their commanders usually assign them to protect underwater installations and command centers.

## INFANTRY UNITS

The Inner Sphere and the Clans use two infantry unit configurations. Unarmored infantry are usually organized into 28- or 21-man platoons. Battle-armored infantry form 5-man Points (Clan) or 4-man squads (Inner Sphere). When these rules refer to infantry, both unarmored infantry platoons and armored infantry Points use those rules. In specific rules for one or the other type of infantry unit, the terms unarmored infantry and infantry platoon refer to non-battlesuited infantry; the terms battle armor, armored infantry, and infantry Point describe units wearing battle armor.



### Foot

Twenty-eight-man foot infantry platoons have no organic transportation, carry light arms, and cannot hope to successfully assault or defend against even the lightest BattleMech. Foot infantry generally provide population control, man city garrisons and mount counterinsurgency operations. Though the start-up cost for such units seems relatively high, they cost very little to maintain. In an additional advantage, most planets can call up and arm thousands of foot infantry on short notice.



### Motorized

Equipped with a variety of light unarmored vehicles, motorized 28-man infantry platoons move about the battlefield more readily than foot infantry, but they still are no match for BattleMechs. Motorized infantry units serve the same duties as foot infantry and also serve as forward observers or reconnaissance personnel.

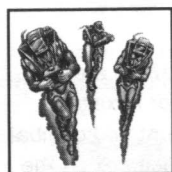

### Jump

The 21 men in a jump platoon are all equipped with jump packs. In open, flat terrain, this equipment makes jump infantry as mobile as motorized troops. In built-up areas, jump-capable troops are more mobile than any other type of infantry. Their jump capabilities allow these troops to close quickly with enemy units, but a close assault of this type can devastate both the defender and the attacker.



### Battle Armor

Battle-armored infantrymen wear powered suits of armor equipped with various weapons. Though some Inner Sphere units field battle-armored troops, such equipment

remains rare and is less powerful than the Clan equivalent. Clan infantrymen, known as Elementals, are organized into 5-man Points. Their individually powered suits of armor mount missiles, small lasers, and anti-personnel weapons. Because Elemental armor can survive direct hits from BattleMech-class weapons, a single Point of battle armor can often disable or destroy a 'Mech.

## RECORD SHEETS

Players use the following record sheets to track various types of information while playing *BattleTech*. Each type of unit (BattleMech, vehicle, infantry, battle armor) uses a unique record sheet. A description of each record sheet appears below, and a blank copy of each appears at the end of this book. Permission is given to reproduce these record sheets for personal use.

## BATTLEMECH RECORD SHEET

Players use the BattleMech Record Sheet to track damage done to a BattleMech during combat. The same record sheet represents both regular 'Mechs and OmniMechs. A unique record sheet is provided for four-legged 'Mechs. The following information describes each section of the record sheet.

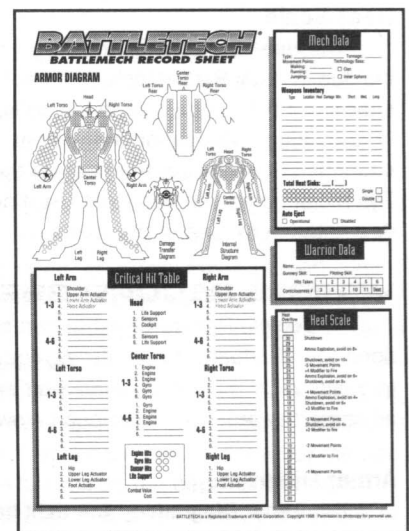

### Armor Diagram

The set of diagrams at the top of the record sheet is referred to as the Armor Diagram, and shows the arrangement of armor plating on the BattleMech. Each circle (referred to as a box) represents a point of armor. Boxes in excess of a specific BattleMech's armor plating are filled in prior to play. As weapon hits destroy a 'Mech's armor, the player checks off the boxes by filling in the affected circles. The Armor Diagram shows the front and rear armor of the BattleMech's torso, the Internal Structure Diagram, and the Damage Transfer Diagram.

The Internal Structure Diagram shows the locations of the BattleMech's internal structures and is used to track damage to those locations. The Damage Transfer Diagram shows where damage will be taken or transferred when a part of the BattleMech already destroyed takes additional damage.

### 'Mech Data

Located in the upper right corner, this section of the record sheet lists the BattleMech's most important statistics, including the BattleMech type, tonnage, movement, weapons inventory, and heat sink boxes.

## Warrior Data

This section lists the name, skills, and condition of the MechWarrior piloting the BattleMech.

## Critical Hit Table

The Critical Hit Table shows the physical location of the BattleMech's critical equipment, weapons, and ammunition. Each part of the 'Mech's body, such as the Left Arm, Right Leg, or Center Torso, is referred to as a *location*. Each line in a location (there are six in the head and legs, twelve in other locations) is referred to as a critical slot, or simply *slot*. Each slot usually represents a particular weapon or other piece of equipment susceptible to destruction. Some equipment occupies so much space in the 'Mech that it requires multiple slots on the table.

## Heat Scale

The Heat Scale helps the player track the internal heat buildup in each BattleMech. As heat builds up, the player checks off these boxes from low to high. At certain levels of heat buildup, information in the right column of the scale describes the effect of the heat on the BattleMech's operation. The blank space marked Heat Overflow is used to record heat generated in excess of 30 points.

## VEHICLE RECORD SHEET

The Vehicle Record Sheet allows players to track damage done to individual vehicles during combat. Each type of vehicle (ground, VTOL and naval) uses a different record sheet, but they all share the features described below.

### Armor Diagram

The Armor Diagram on the right-hand side of the record sheet shows the arrangement of the vehicle's armor plating and internal structure. As weapons hits destroy the armor, the player fills in the circles (checks off the boxes). When all the boxes in one section are filled in, damage transfers to the adjacent internal structure. The shaded areas of the Armor Diagram show the locations of the vehicle's internal structure.

### Vehicle Data

The Vehicle Data section lists the vehicle's other important statistics, including its tonnage, movement, weapons inventory and other compo-

nents. The player also records the crew's Driving and Gunnery Skills here. Beneath the spaces for Driving Skill and Gunnery Skill, VTOL and submarine record sheets include a Turn Column and an Elevation Column, which the player uses to track the VTOL's elevation or the submarine's depth at the end of the vehicle's movement. The current elevation of a VTOL cannot be

lower than the level of the terrain over which the VTOL is moving, nor can the current depth of a submarine be greater than the water's depth or less than 0.

## BATTLE ARMOR RECORD SHEET

Each Battle Armor Record Sheet can record the information for ten Points or squads of battle armor. The record sheet is designed to accommodate any type of battle armor for the Inner Sphere or Clans. Simply fill in each Point or squad's appropriate weapons and cross off any excess armor boxes or troopers.

Each of the Point's five rows represents a single trooper.

As a trooper takes damage, the player checks off the boxes in that trooper's row. When all the boxes are checked off, that trooper is out of the battle.

## INFANTRY RECORD SHEET

Infantry Record Sheets come five to a page and are used for all unarmored infantry platoons. Each record sheet has four rows. Use the top row to record the number of men in the unit. As the unit takes damage, check off these boxes to reflect the platoon's casualties. The remaining three rows show the damage that a specific unit can do, depending on the number

of men in the platoon and the type of weapons the platoon is using. For example, a full-strength rifle platoon inflicts 7 points of damage each time it hits, while an 11-man laser platoon does 6.

The record sheet also provides an Infantry Range Modifier Table for each of a platoon's possible weapon types.

## MAPSHEETS

The 22-by-17 inch mapsheets used in *BattleTech* are divided into six-sided areas called hexes (short for hexagon). The players use these hexes to regulate movement and combat by moving units from hex to hex during a turn. Each hex on the mapsheet represents an area of ground 30 meters across (roughly 100 feet).

The forests, rivers, hills, buildings and rough areas on a *BattleTech* mapsheet represent a typical mixture of the terrain found on the habitable worlds of the Inner Sphere. The following symbols represent each type of terrain as described, and the accompanying text gives an overview of the terrain's effects.

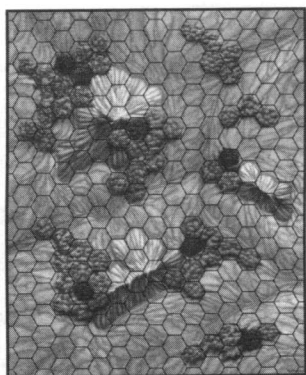

Specific rules regarding the effect of terrain on movement and combat appear in the Movement and Combat sections.

## Elevation

The elevation of a hex is the height to which it rises above the prevailing terrain. All terrain has an elevation; the elevation of a hex is independent of the type of terrain it contains, such as woods or water. Hexes with elevations higher than 0 are also referred to as hills. If it is not marked on the map, assume a hex's elevation level is 0.

Elevation is expressed in terms of elevation levels, or simply *levels*. Level 1 is 6 meters high (waist-high to a BattleMech): a BattleMech standing behind a Level 1 hill may be partially hidden, and a vehicle behind a Level 1 hill is completely hidden. Elevation Level 2 terrain is 12 meters high (the same height as a BattleMech): a BattleMech standing behind Level 2 terrain is completely hidden. Level 3 terrain is 18 meters high, and so on.

If any part of a hex contains an elevation level, the level of the entire hex is considered to be equal to the highest elevation present in the hex.

**Sublevels:** Hexes with elevation levels lower than 0 are referred to as sinkholes. These hexes are marked in Sublevels that correspond to elevation levels in reverse; a Sublevel 1 hex is 6 meters deep, while a Sublevel 2 hex is 12 meters deep and so on.

If any part of a hex contains a sublevel, the entire hex is considered to be the deepest sublevel marked in the hex. The exception to this rule is if there is also an elevation greater than 0 marked in the same hex, in which case the level of the hill takes precedence in the hex as described above.

If any part of a hex contains a sublevel, the entire hex is considered to be the deepest sublevel marked in the hex. The exception to this rule is if there is also an elevation greater than 0 marked in the same hex, in which case the level of the hill takes precedence in the hex as described above.

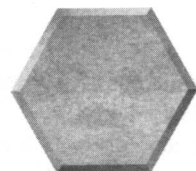

## CLEAR

Clear terrain represents fields, meadows and other grasslands. The ground is firm and may be gently rolling, but its elevation does not change significantly from one side of the hex to the other.

If a hex is not clearly marked as containing another terrain type, assume it is clear.

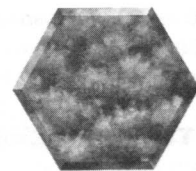

## LIGHT WOODS

Light woods terrain is covered with sparse trees of up to 12 meters in height. BattleMechs cannot cross this terrain as easily as clear terrain. Unless the wood is relatively large, units may have line of sight through light woods. When light woods affect line of sight, they do so for 2 elevation levels above the elevation of their hex. (See *Intervening Terrain in Combat*, p. 25).

When light woods affect line of sight, they do so for 2 elevation levels above the elevation of their hex. (See *Intervening Terrain in Combat*, p. 25).

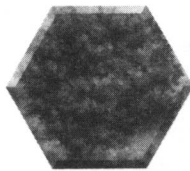

## HEAVY WOODS

Heavily wooded terrain is covered thickly with 12-meter-tall trees, making movement through these areas very difficult. Light woods often border heavy woods. It is very difficult to see through heavy woods. As with light woods, heavy woods affect line of sight for 2 levels above the elevation of their hex. (See *Intervening Terrain in Combat*, p. 25).

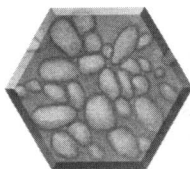

## ROUGH

Rough terrain represents broken, rocky and jumbled ground. Though firm, the unevenness of this type of terrain makes it more difficult to cross than clear terrain. Commonly encountered near cliffs and bluffs, rough ground may also be formed as a result of the destruction of woods.

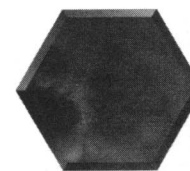

## WATER

Water terrain hexes are covered by streams, rivers, swamps, ponds or lakes. A Water hex is defined by depth levels (see *Elevation*, p. 11). Depth 0 water is very shallow, only ankle-deep on a BattleMech, and represents terrain such as streams, swamps or shallow ponds. Depth 1 water is 6 meters deep, or 1 level below ground level (about waist-high on a BattleMech). Depth 2 water is 12 meters deep, deep enough to just cover a BattleMech. Depth 3 water is 18 meters deep, and so on.

Water hexes effectively have two elevations, the surface of the water and the bed (or floor) of the body of water. The level of the surface is equal to the level of the hex. The level of the bed is equal to the level of the hex minus the depth of the water. For example, for a Depth 2 river in a Level 3 hex, the surface is at Level 3 while the riverbed is at Level 1.

Even when a shallow stream fills only part of a hex, that entire hex is considered a Water hex, as described in *Sublevels*, p. 11.

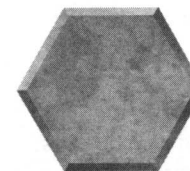

## PAVEMENT

A Paved hex offers a fairly smooth and very hard surface. Paved hexes typically include roads, sidewalks, and landing fields made of asphalt, cement, or even cobblestone. This terrain increases the speed of ground vehicles, but running BattleMechs and vehicles moving at flank speed may skid on Paved hexes (see *Pavement Movement*, p. 20).

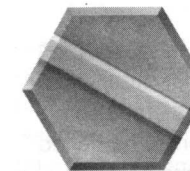

## ROADS

Roads are narrow strips of pavement that pass through other terrain. All the rules that apply to pavement apply to roads, with the exception that units must move from one hex of a road to another hex of the same road to be considered "on" the road. A unit not on the road in a hex is considered to be moving on the underlying terrain type.

# COMPONENTS

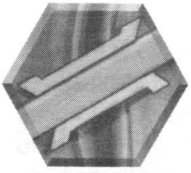

**Bridges:** When a road passes over water, that road is considered a bridge. Units moving along a road may use a bridge and so ignore the normal terrain restrictions and movement penalties they otherwise would suffer while moving in a Water hex. The

Construction Factor of a bridge represents the amount of weight the bridge can bear. If a bridge is not strong enough to support the weight of the crossing unit, it will collapse. (See *Collapse*, p. 52 in *Buildings*.)

## COUNTERS

Certain features of terrain, such as buildings, rubble, fire and smoke, can be represented on the map by counters made of cardboard or paper. Such counters are available in other FASA products, or you can make your own out of cardboard or paper. Rather than printing these kinds of features directly on the maps, using counters to represent them allows the players to alter their locations before the game begins, based either on the requirements of the scenario being played or on mutual player agreement.

The following text is an overview of counters used in the game and their effects. Specific rules regarding their effects on movement and combat can be found in the appropriate sections later in this book.

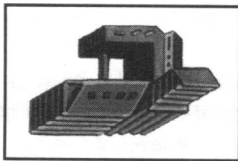
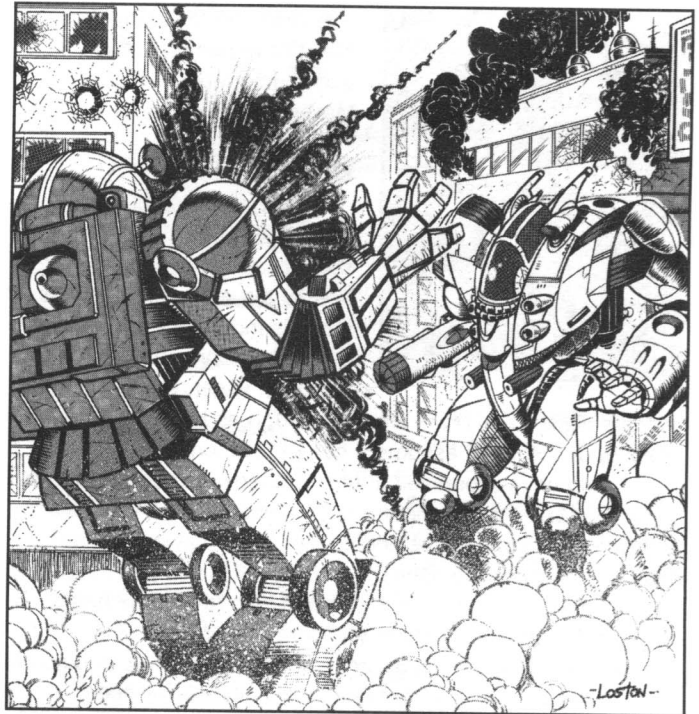

### LIGHT BUILDINGS

Light buildings generally represent small wooden or sheet-metal structures through which most BattleMechs can walk with little or no trouble.

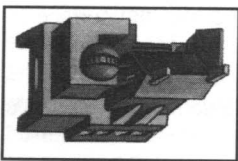

### MEDIUM BUILDINGS

Constructed from stone, heavy wood, and metal, Medium buildings represent light industrial structures that offer more substance than Light buildings. Their heavier construction materials

mean they can take more damage than Light buildings before being reduced to rubble.

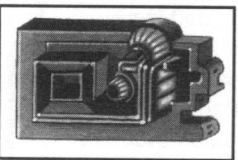

### HEAVY BUILDINGS

Usually part of industrial complexes, Heavy buildings are constructed of reinforced concrete, built to bear very heavy loads. All but the heaviest BattleMechs can land on Heavy

buildings without collapsing the structure.

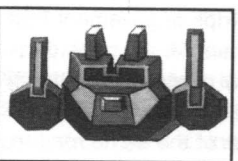

### HARDENED BUILDINGS

The builders intentionally strengthen Hardened buildings to withstand combat. Of all types of buildings, hardened structures can bear the most weight and sustain the most damage before

being reduced to rubble.

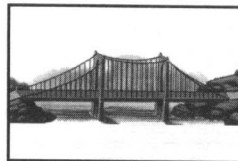

### BRIDGES

Bridges can be added to a map in the form of counters, which function just like other types of bridges (see *Roads*, p. 11).

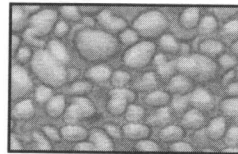

### RUBBLE

Weapons fire, fire damage and physical damage inflicted by BattleMechs can reduce a building to rubble. A Rubble hex is difficult to move through.



### FIRE

If fire is present on the map, each hex in flames must be marked with a Fire counter. These counters are only used if the rules for *Fire*, p. 74, are in effect.

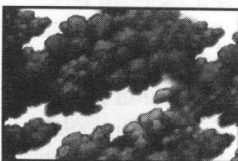

### SMOKE

Fire and special artillery rounds can generate smoke, and these counters represent hexes obscured by smoke.

### DICE

*BattleTech* requires players to use two six-sided dice, preferably of two different colors. If the situation requires the player to roll one die, the rules indicate this in shorthand as 1D6. Unless otherwise noted, the abbreviation 2D6 means the player rolls both dice and adds the results together.

## PLAYING THE GAME

This section provides the sequence of play for *BattleTech* and presents the basic rules for playing MechWarriors in *BattleTech*.

To begin a game, the players lay out the *BattleTech* mapsheets on a table or on the floor in a way agreed to by all players, or, if using a FASA scenario pack, according to the *Game Setup* of the scenario to be played. This step may include placing a number of buildings of varying height and type on the mapsheets, or other types of counters. See *Creating Scenarios* (p. 97) for guidelines for creating your own scenarios.

Next, the players fill out record sheets for each of their units involved in the battle. The BattleMech and vehicle descriptions required to fill out unit record sheets can be found in any of the *BattleTech Technical Readouts*, or completed record sheets can be copied from any of the *BattleTech Record Sheets* books. If all players agree, units may be created using the *Construction* rules, p. 109. If the players decide to use OmniMechs or OmniVehicles, they may customize their weapons and equipment load. (See *Outfitting an OmniMech*, p. 120).

### SEQUENCE OF PLAY

A *BattleTech* game consists of a series of turns. Each turn represents 10 seconds of game time. During each turn, all units on the map have an opportunity to move and fire their weapons. Each turn consists of several smaller segments of time, called phases. During each phase, players will take one specific type of action, such as movement or combat.

The players execute the phases of every turn in a specific order. Specific actions, movement, effects of damage, and so on are fully explained in separate sections later in this book. Each turn includes the following phases, performed in the following order:

- Initiative Phase
- Movement Phase
- Weapon Attack Phase
- Physical Attack Phase
- Heat Phase
- End Phase

### INITIATIVE PHASE

1. One player from each side rolls 2D6 and adds the results together to determine his team's Initiative. The team with the higher result has the Initiative throughout the turn. Reroll a tied result.

### MOVEMENT PHASE

2. The team that lost the Initiative chooses one unit and moves it first. If this team has more units than the team that won the Initiative, it may need to move more than one unit, as described in *Unequal Numbers of Units*, p. 14.

3. The team that won the Initiative moves one unit. If this team has more units than the team that lost the Initiative, it

may need to move more than one unit, as described in *Unequal Numbers of Units*, p. 14.

Movement alternates between sides until all units have been moved. Each time a player is required to move a unit, he may designate a movement for any unit that has not been destroyed, even if the move is to simply stand (or lie) immobile.

### WEAPON ATTACK PHASE

4. The team that lost the Initiative chooses a unit to declare fire first. If this team has more units than the team that won the Initiative, it may need to declare attacks for more than one unit as described in *Unequal Numbers of Units*, p. 14. The player controlling that unit declares whether that unit will twist its torso or turn its turret, and in which direction. He must declare any attacks he plans to make using his unit's weapons, specifying which weapons he will fire and at what target(s). If a weapon uses special ammo loads, such as LB-X cluster munitions, or can make special types of attacks or produce any other unusual effects, those effects must also be declared at this time.

5. The team that won the Initiative chooses a unit to declare fire next. If this team has more units than the team that lost the Initiative, it may be required to declare attacks for more than one unit as described in *Unequal Numbers of Units*, p. 14. The player controlling that unit declares any torso twist and attacks he plans to make using that unit's weapons as described above.

The act of declaring attacks alternates between players until all fire has been declared. Each time a player is required to declare attacks for a unit, he may declare an attack for any unit that has not been destroyed, even if the declaration is to not make any attacks.

6. Weapons fire is resolved one unit at a time. All weapons attacks by one unit should be resolved before those of the next unit in order for the players to more easily track which weapons have fired.

Note that all declared attacks must be made, even if the intended target is destroyed before all attacks against it have been resolved; all declared weapons fire must be resolved for the purpose of tracking ammunition and heat. In addition, all declared attacks must be made because the Weapon Attack Phase represents only a few seconds of time, during which the general confusion of battle makes it impossible to change targets or realize that the target is destroyed in time to choose not to fire.

7. Damage from weapons attacks takes effect. Players record damage as attacks are resolved, but this damage does not affect the unit's ability to attack in this phase. This means a unit may make its declared attacks even if the unit or its weapons are destroyed. At the end of the phase, all damage takes effect immediately and players must make any Piloting Skill Rolls required according to the effects of weapons attacks. Note that damage taken by a unit during the Weapon Attack

# PLAYING THE GAME

Phase takes effect before the start of the same turn's Physical Attack Phase.

## PHYSICAL ATTACK PHASE

8–11. Repeat Steps 4 through 7 for physical attacks, with all damage from these attacks taking effect before the Heat Phase. Note that torso twists are not made during Steps 8 or 9. Torso twists are made during Weapon Attack declaration, but the torso remains twisted in the same direction throughout the remainder of the turn, affecting physical attack firing arcs as well.

## HEAT PHASE

12. Players adjust their BattleMechs' Heat Scale to reflect any heat built up or lost during the turn. Resolve any temporary or permanent damage caused by excessive internal heat at this time. Note that vehicles and infantry do not keep track of heat. See *Heat*, p. 46 for specific rules regarding this phase.

## END PHASE

13. Players whose MechWarriors lost consciousness in a previous turn now roll 2D6 to see if the pilot regained consciousness during this turn.

14. Players execute any miscellaneous actions remaining in the turn, such as determining if any fires now on the mapsheet spread to other hexes and switching heat sinks on or off. The specific rules for such actions will state whether or not they take place during the End Phase. Torsos and turrets that have been twisted or turned return to a forward-facing position at this time.

15. Repeat Steps 1 through 14 until one team meets its victory conditions. Under normal circumstances, the team with the last surviving unit left on the map wins the scenario. If the last units from each team are destroyed simultaneously, the game is a draw. The players may set other victory conditions by mutual agreement before play begins or by using the *Victory Conditions* given for each scenario in the FASA scenario pack being played. See *Creating Scenarios* on page 97 for guidelines on setting up unique scenarios.

## UNEQUAL NUMBERS OF UNITS

The Movement Phase, Weapon Attack Phase and Physical Attack Phase require each player to alternate moving or declaring attacks with their units. In a turn consisting of an equal number of units on each side, each player simply takes a turn moving or declaring a single unit's action, then the other player declares movement or an action for one unit, and so on. If the number of units on each side are not equal, however, this procedure must be altered.

If, prior to any pair of movement or attack declarations, one team has twice as many units left to declare for as the other team, the team with twice as many units declares for two units rather than one. If one team has three times as many units, it declares for three each time, and so on.

*For example, at the beginning of the Movement Phase, Side A has 8 units and Side B has 5 units. Side*

*A wins the Initiative. Before the first pair of movements, Side A does not have double or more the number of units Side B has remaining to move, so Side B moves one unit, then Side A moves one unit. Now, Side A has 7 units left to move while Side B has 4 units left to move. Since Side A still does not have twice as many units left to move, each side again moves one unit. Before the third pair of movements, Side A has 6 units left to move, twice as many as Side B has left to move. This means Side A must now move two units for every one unit Side B moves.*

*Here is a breakdown of how many units each player would move in this example turn.*

Move No.	Side B Units Left to Move	Side A Units Left to Move	Side B Moves	Side A Moves
1	5	8	1	1
2	4	7	1	1
3	3	6	1	2
4	2	4	1	2
5	1	2	1	2

## WARRIORS

The human soldiers who pilot BattleMechs are called MechWarriors. Their skills play an important role in keeping a BattleMech moving and fighting effectively in combat. A BattleMech will be knocked out of action if its MechWarrior is killed or seriously injured, even if the BattleMech suffers only minimal damage. The crews of vehicles and infantry troopers also have skills that affect their abilities in combat.

## SKILLS

Though warriors actually have many different skills, for the purposes of the *BattleTech* game they use only two skills in combat, Piloting and Gunnery. Skills are rated according to a skill level, and the lower the skill level, the better the skill.

A MechWarrior's Piloting Skill represents his skill at controlling his machine's movements, including keeping his BattleMech from falling down, as discussed in *Piloting Skill Rolls* (see *Movement*, p. 22). A MechWarrior's Gunnery Skill helps determine how easy or difficult it is for the pilot to make a successful shot using the BattleMech's weapons, as discussed in *Firing Weapons* (see *Combat*, p. 28).

**Vehicles:** Vehicle crews have Driving Skill rather than Piloting Skill, but it is used in the same way as Piloting Skill.

**Infantry:** Infantry units have Gunnery Skill but no Piloting Skill.

## Default Skill Levels

Inner Sphere MechWarriors of average skill have a Piloting Skill level of 5 and a Gunnery Skill level of 4. Clan MechWarriors of average skill have a Piloting Skill level of 4 and a Gunnery Skill level of 3. Though these skill levels can be different (see *Skill Improvement*, p. 15), unless otherwise stated by the scenario being played, assume all warriors have the average skills as shown on the Average Skills Table. Rather than defaulting to

## AVERAGE SKILLS TABLE

Warrior Type	Piloting Skill	Gunnery Skill
<i>Inner Sphere</i>		
MechWarrior	5	4
Vehicle Crew	5	4
Infantry	—	4
<i>Clan</i>		
MechWarrior	4	3
Vehicle Crew	6	5
Infantry	—	4

these skill levels, players may use the *Experience Level and Skills* rules on p. 108.

### Making Piloting Skill Rolls

When a BattleMech or vehicle attempts a potentially dangerous maneuver, or when the pilot might lose control of the unit for some other reason, the pilot must make a Piloting Skill Roll (see *Piloting Skill Rolls*, p. 22 in *Movement*).

### Gunnery Skill Rating

A unit's base to-hit number is equal to its Gunnery Skill level. When modified for range, terrain and other factors, this number becomes the modified to-hit number (see *Firing Weapons*, p. 28).

## SKILL IMPROVEMENT

Players may want to use the warriors they create in future scenarios or in *BattleTech* campaign games—assuming, of course, that the warrior survives the current battle. This is an optional rule that should only be used if all players agree and will all be keeping track of skill advancement for their forces.

In this case, players should keep track of Experience Points for each warrior (MechWarrior, vehicle crew, or infantry unit) who survives a scenario. Each warrior who survives earns 1 Experience Point. In addition, each player must award a bonus Experience Point to one of the warriors on the enemy team who survived the scenario (if there were any survivors), based on his opinion of which warrior was the bravest, scored the most damage, or any other desired criteria.

After each scenario, any warrior may spend accumulated Experience Points on skill improvement. Improving Piloting Skill costs 4 points, while improving Gunnery Skill costs 8 points. Each improvement reduces the improved skill's rating by 1.

*MechWarrior*, the roleplaying game for the *BattleTech* universe, offers a more comprehensive character creation system and skill advancement that can be used in place of these rules.

**Maximum Skill Levels:** No skill level can be improved beyond a rating of 0.

## DAMAGING A MECHWARRIOR

Three types of damage to a BattleMech can also damage the MechWarrior inside: head hits, falling, and internal ammuni-



tion explosions. In addition, excessive heat buildup can result in damage to the MechWarrior if the BattleMech's life support system takes damage.

Note that vehicle crews and infantry troopers do not take damage in the same way as MechWarriors. See the appropriate rules for these types of units in *Vehicles*, p. 54 and *Infantry*, p. 59.

A MechWarrior can take 5 points of damage before dying from his injuries.

### Head Hits

The MechWarrior takes 1 point of damage whenever the BattleMech's head is hit, even if the hit does not penetrate the 'Mech's armor.

### Falling

If the BattleMech falls, the MechWarrior must make a Piloting Skill Roll. If he fails the roll, the pilot takes 1 point of damage.

### Ammunition Explosions

An internal ammunition explosion causes 2 points of damage to the MechWarrior as a result of the electric shock he receives through his neurohelmet.

### Excess Heat

When the life support systems have taken a critical hit, the MechWarrior suffers 1 point of damage every turn that the BattleMech's internal heat is 15 or higher on the Heat Scale at the end of the Heat Phase. Every turn that the heat is 26 or higher causes 2 points of damage to the MechWarrior.

## CONSCIOUSNESS ROLLS

A MechWarrior can survive with up to 5 points of damage, but he may be knocked unconscious long before taking that much damage. Every time the MechWarrior takes a point of damage, the player must roll 2D6 at the end of that phase, before making any Piloting Skill rolls, and consult the MechWarrior Consciousness Table. This roll is made for every point of damage taken, so in the case of an ammunition explosion, the pilot will make two consecutive consciousness rolls.

If the die roll result is equal to or greater than the consciousness number, the MechWarrior remains conscious. If the result is less than the consciousness number, the MechWarrior is knocked unconscious. The BattleMech becomes an immobile target, unable to move, fire, or take any other action. No equipment (except heat sinks) on the 'Mech functions as long as the pilot is unconscious.

**Immobile Target:** A 'Mech with an unconscious pilot is an immobile target, and therefore may be targeted by aimed shots as described on page 31.

**Piloting Rolls:** Any Piloting Skill Rolls that the player must make for the BattleMech while the pilot is unconscious automatically fail.

**Recovering Consciousness:** During the End Phase of each turn after the turn in which the MechWarrior lost consciousness, the player rolls 2D6.

If the result is equal to or greater than the consciousness number for the MechWarrior's current level of damage, the MechWarrior regains consciousness. The player need not roll again to determine consciousness until the MechWarrior takes new damage.

### MECHWARRIOR CONSCIOUSNESS TABLE

Total Damage Points	Consciousness Number
1	3
2	5
3	7
4	10
5	11
6	Dead

A MechWarrior who has taken 6 hits is dead and cannot regain consciousness.

*In Turn 3, a Grasshopper takes a hit to the head from an attack with a medium laser. Though the laser does not penetrate the head's protective armor, the Grasshopper's pilot takes 1 point of damage. He took 2 points of damage in previous attacks, and so now has a total of 3 points of damage. The player consults the MechWarrior Consciousness Table and rolls a 6, 1 point less than his pilot needed to remain conscious. The Grasshopper will not be able to move or fire during Turn 4. In the End Phase of Turn 4, the player rolls 2D6 again. If he rolls a 7 or higher, the MechWarrior regains consciousness, and his BattleMech will be able to move and fire normally during Turn 5.*



## MOVEMENT

*BattleTech* units change their position and location on the mapsheet by performing any one of several movements or movement actions. During the Movement Phase of each turn, each player must choose one mode of movement (walking, running, or jumping for BattleMechs; cruising or flank speed for vehicles) that his unit will use during that turn.

When it is his turn to move a unit, the player must announce what movement mode he is using. Within the limits of the rules, the player always chooses how a unit moves.

### MOVEMENT BASICS

A unit spends 1 Movement Point (MP) to move 1 hex. If the unit is entering a hex containing anything other than Clear terrain, this cost usually increases, as shown in the Movement Cost Table, p. 18. (See also *Mapsheets*, p. 10, for more information on terrain.)

**Water:** Water hexes have a depth that functions in the same way as elevation (see p. 11), but in reverse. Units entering Water hexes must pay the MP cost for entering water plus the cost for the elevation change (if any).

**Difficult Terrain:** For some terrain, a player must make a successful Piloting Skill Roll in order for a BattleMech to remain standing once it enters that terrain. These types of terrain are marked as such in the Movement Cost Table.

**Prohibited Terrain:** Certain kinds of units may not enter certain types of terrain. These movement restrictions appear on the Movement Cost Table.

### Elevation Change

While moving forward, a BattleMech may change elevation or depth by only 1 or 2 levels per hex. Ground vehicles and infantry may only change 1 elevation level per hex. (This rule does not apply to a jumping unit. See *Jumping*, p. 19). Elevation changes greater than these are considered prohibited terrain.

**Vehicles:** VTOL vehicles and submarines must spend 1 MP to change their elevation by 1 level. Ground vehicles must spend 2 MP to change their elevation by 1 level.

**Infantry:** Infantry must spend 2 MP to change their elevation by 1 level.

### Minimum Movement

A unit must possess sufficient MP to pay the cost of entering each new hex. However, a unit can always move into the hex directly in front of it at the beginning of the Movement Phase, regardless of the terrain cost, provided it is the only expenditure of MP the unit makes in that turn. This kind of move can only be made if the unit has at least 1 MP to spend (i.e., is mobile) and the unit is not prohibited from entering that terrain. A unit that enters a hex under these conditions is considered to have used running movement.

A prone BattleMech with only 1 MP available can make a single attempt to stand using the Minimum Movement rule.

### Prone BattleMech Movement

A BattleMech that is prone at the beginning of its movement may declare walking or running movement but may not jump. The 'Mech can use its MP to attempt to stand (see *Standing Up*, p. 20). Though a prone BattleMech cannot crawl into another hex, it may change its facing in the hex it occupies at the standard cost of 1 MP per hexside.

### MOVEMENT DIRECTION

A BattleMech or vehicle can move forward into the hex it is facing or backward into the hex directly to its rear. It cannot move into any other hex unless it first changes its facing (see *Facing*, p. 17). The diagram below shows the two hexes that a BattleMech or vehicle may enter without changing its facing.

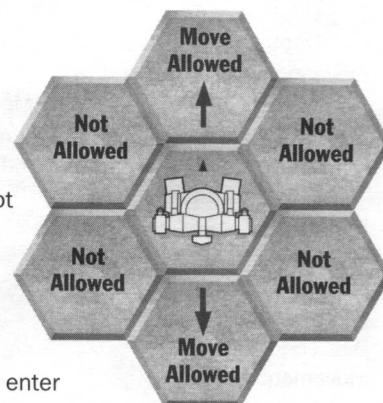

**Infantry:** Because infantry units have no facing, they may enter any of the six hexes surrounding the hex they occupy, subject to terrain restrictions.

### Backward Movement

During the course of its movement, a BattleMech or vehicle can move forward and backward and change direction in any manner the player chooses, as long as the unit possesses the required number of Movement Points. However, a BattleMech may not run backward, nor may a vehicle move backward at flank speed.

**Elevation Change:** Units moving backward may not change elevation levels.

### FACING

Every hex on the map has six edges, called hexsides. In *BattleTech*, every BattleMech and vehicle must be oriented to face one of those six hexsides. A BattleMech is considered to be facing the way its feet are pointing. A vehicle is considered to be facing in the direction of its front side. A unit's facing affects both movement (see below) and combat (see *Combat*, p. 25), and can only be changed during the Movement Phase.

**Infantry:** Infantry units have no facing.

**Violations:** Units not clearly facing a hexside can be realigned to one of the two closest hexsides by the opposing player.

### FACING CHANGE

Changing a unit's facing costs 1 MP per hexside changed. For example, a 180-degree turn would cost a BattleMech or vehicle 3 MP.

# MOVEMENT

## MOVEMENT COST TABLE

Terrain Type/Activity	MP Cost Per Hex	Prohibited Units
Clear	1	Naval
Paved/Road/Bridge	1 <sup>3</sup>	Naval
Rough	2	Wheeled, Naval
Light Woods	2	Wheeled, Hover, Naval
Heavy Woods	3	Ground, Naval
Water		
Depth 0	1	Naval
Depth 1	2 <sup>1</sup>	Infantry, Ground <sup>4</sup>
Depth 2+	4 <sup>1</sup>	Infantry, Ground <sup>4</sup>
Elevation Change (up or down)		
1 level	+1 ('Mechs, VTOL, Subs) +2 (Infantry, Ground)	—
2 levels	+2 ('Mechs, VTOL, Subs)	Infantry, Ground
3+ levels	+1/level (VTOL, Subs)	'Mechs, Infantry, Ground
Rubble	2 <sup>1</sup>	Wheeled, Naval
Light Building	2 <sup>2</sup>	Naval
Medium Building	3 <sup>2</sup>	Naval
Heavy Building	4 <sup>2</sup>	Naval
Hardened Building	5 <sup>2</sup>	Naval
Movement Actions		
Facing Change	1/hexside <sup>5</sup>	
Dropping to the Ground	1	
Standing Up	2/attempt	

<sup>1</sup>Piloting Skill Roll required to prevent falling.

<sup>2</sup>Piloting Skill Roll required to prevent damage; infantry pay only 1 MP to enter or leave any building.

<sup>3</sup>If traveling along road; otherwise cost of underlying terrain.

<sup>4</sup>Hovercraft may enter all Water hexes.

<sup>5</sup>No cost for infantry.

A player wants to move the BattleMech in the diagram from Hex A to Hex B. However, the BattleMech is currently facing Hex C, and so cannot legally move to

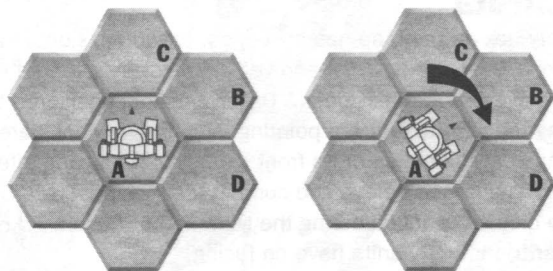

Hex B. If the BattleMech changes its facing, as shown in Figure 2, the BattleMech can now legally move into Hex B. This facing change costs 1 MP.

If the player wanted to move the BattleMech into Hex D (without moving backward), the BattleMech would have to make a two-hexside facing change, at a cost of 2 MP.

In the diagram

above, the BattleMech in Hex A has 4 MP (walking) or 6 MP (running).

The player declares that the BattleMech will walk this turn.

It will cost all 4 of the BattleMech's available MP to walk straight ahead into Hex B (1 MP) and then forward again into the Heavy Woods in Hex C (3 MP). It would cost all 4 MP for the BattleMech to move into Hex B (1 MP), then change its facing (1 MP) and move into the Light Woods in Hex D (2 MP). The BattleMech's walking MP of 4 is not enough to get it to Hex E because it would have to move forward into Hex B (1 MP), then change its facing one hexside (1 MP), then enter the Depth 1 Water hex (2 MP), which would require an additional 1 MP for the elevation level change (total 5 MP). Finally, if the player wanted to move his BattleMech from Hex A directly to Hex F, he would first have to change facing (1 MP), and then, after climbing 2 elevation levels (2 MP), enter the open terrain (1 MP).

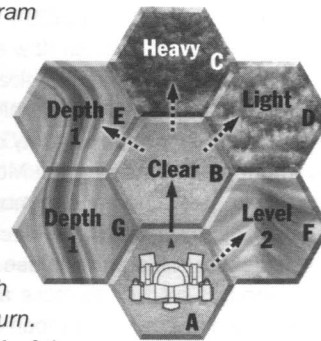

## MOVEMENT MODES

At the beginning of each unit's movement, a player must select one of the following movement modes for his BattleMech or vehicle. A unit may not combine movement modes during a turn.

**Vehicles:** Vehicles use cruising speed rather than walking speed, and flank speed rather than running speed. The terms walking and running are used in the rules for simplicity, but in all ways these rules also equally apply to cruising and flank speed movement, respectively.

**Infantry:** Infantry units have no movement modes.

### STANDING STILL

If the player declares that the unit will stand still, the unit stays in the hex in which it started the turn. It may expend no MP during the turn. It does not move at all, not even to change facing. Standing still generates no heat, gives no penalty to weapons fire, and allows attackers to fire on the unit without target movement penalties.

### WALKING

If the player declares that the unit will walk (cruise), the unit may expend a number of MP up to its walking MP rating. A

# MOVEMENT

walking unit suffers a small penalty to its to-hit number when firing weapons. As a moving target, a walking unit may also be harder to hit. These combat effects appear on the appropriate To-Hit Modifier Tables in the *Combat* section, p. 25, and are explained in that section.

**Heat:** Walking creates 1 point of heat for BattleMechs.

## RUNNING

A unit can move further in a turn when running (or moving at flank speed) than it can walking. The player may spend up to the Running MP rating of the unit each turn. A unit that is running suffers penalties to its to-hit number when firing weapons, but its speed may make the unit a more difficult target to hit. These effects are explained in the *Combat* section, p. 25. In addition, a unit using running movement on a paved surface may skid (see *Skidding*, p. 21).

**Backward Movement:** No unit can move backward while running.

**Water:** No unit can enter Water hexes of Depth 1 or deeper while running, though a running unit may leave a Water hex.

**Heat:** Running creates more heat for a BattleMech (2 Heat Points per turn) than does walking.

**MP Reduction:** Certain damage to a unit may reduce its Walking/Cruising MP rating. When such damage occurs, the unit's running/flank speed must be recalculated. A unit's Running/Flank MP rating is always equal to its Walking/Cruising MP times 1.5, rounding up.

**Critical Damage:** Before they begin their movement, BattleMechs that run with damaged hip actuators or a damaged gyro must make a Piloting Skill Roll to avoid falling. (See *Piloting Skill Rolls*, p. 22).

## JUMPING

Not all units can jump. Only some BattleMechs and some battlearmed troops are jump-capable, along with jump infantry. A jump-capable unit will be listed as having Jumping MP or it will be described as jump-capable in the rules specific to that unit. Jumping allows the most flexibility in movement, but generates a great deal of heat. Jumping also makes it harder to fire weapons accurately, but a jumping BattleMech makes a more difficult target than a running or walking BattleMech. These effects are explained in the *Combat* section, p. 25.

BattleMechs must be standing at the start of the turn in order to jump. When a unit jumps, it can move 1 hex for every available Jump MP. It may jump in any direction, regardless of its original facing. The player chooses a target hex for the unit to jump into; then the unit travels to that hex along the shortest possible route. A unit can jump over and into any hex, regardless of terrain type. If this path crosses an elevation higher than the sum of the unit's Jump MP plus the elevation of the hex the jump started in, then the unit cannot make the jump. If there is more than one possible path between the unit and its goal hex, the player may declare which path his unit takes.

**Water:** Jump jets cannot be fired while submerged in water, and so a 'Mech standing in Depth 2 or deeper water cannot jump. If a 'Mech is standing in Depth 1 water, it may not fire

jump jets located in its legs, but it may use any jets located in the torso, each one providing 1 Jumping MP. For example, a 'Mech with a Jumping MP of 5 that has one jump jet in each leg and each torso location may only use 3 MP when jumping out of Depth 1 water.

**Critical Damage:** BattleMechs that jump with destroyed hip or leg actuators or a damaged gyro must make a Piloting Skill Roll to avoid falling when they land. (See *Piloting Skill Rolls*, p. 22).

**Heat:** Jumping generates a great deal of heat, 1 Heat Point for every hex jumped with a minimum cost of 3 Heat Points. Even if a BattleMech only jumps 1 hex, it builds up 3 Heat Points for that jump.

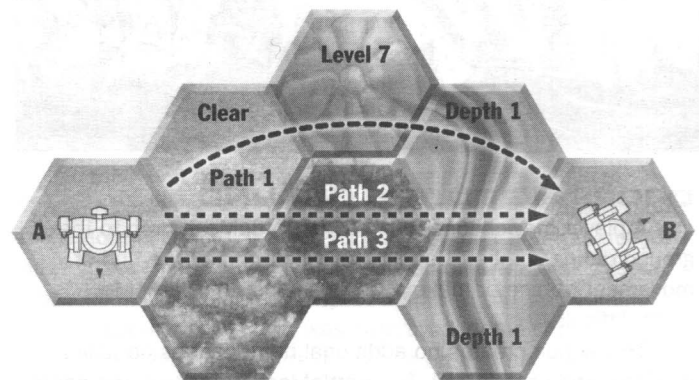

The BattleMech in Hex A of the diagram above has a Jumping MP of 6. The BattleMech jumps to Hex B, 4 hexes away. Because the BattleMech is using jump movement, it spends only 1 MP for every hex that it moves, ignoring all terrain costs for the hexes it passes over and for the hex in which it lands. As it lands, the player can face the BattleMech in any direction he chooses, at no extra cost. To reach Hex B with the facing shown by walking or running, the BattleMech would have had to spend at least 13 MP.

The BattleMech could have jumped into Hex B by at least three paths, as indicated on the diagram. Path 1 cannot be chosen because a hill in the intervening terrain has an Elevation Level of 7, and the 'Mech has a Jump MP rating of 6, but the player still could have chosen Path 2 or 3. If the elevation level of Hex A was 1 or higher, then the 'Mech could have traveled to its destination along Path 1, because the unit's Jump MP (6) plus the elevation of the starting hex (1) would equal or exceed the level of the intervening hilly terrain.

## MOVEMENT ACTIONS

Units may take several movement actions aside from simply moving forward and backward across terrain, as described below.

### FACING CHANGE

Every hexside by which a unit changes its facing costs 1 MP. See *Facing*, p. 17.

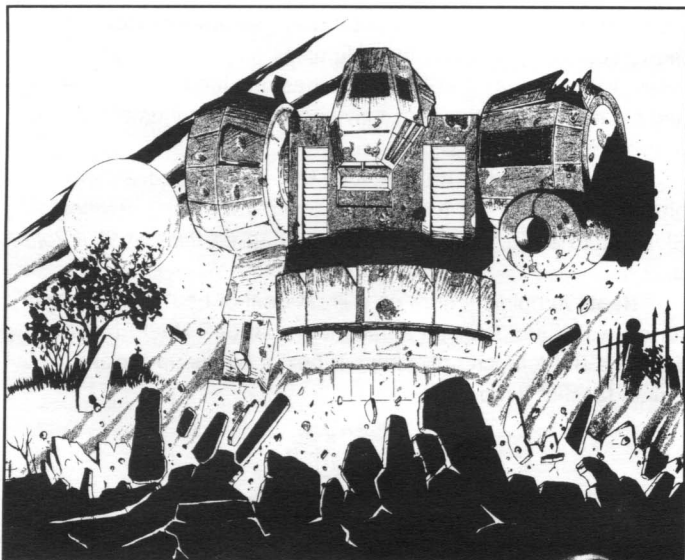

## DROPPING TO THE GROUND

A player may choose to have his BattleMech drop to the ground during combat. Usually, he will do this at the end of movement to hide or make attacks against the BattleMech more difficult.

This action creates no additional heat, causes no falling damage, and costs 1 MP. The BattleMech drops with the same facing it had while standing and is automatically face down, as in an unintentional fall (see *Falling*, p. 22). The 'Mech is thereafter considered prone, and to regain its feet it must attempt to stand as described in *Standing Up*.

## STANDING UP

The player may choose to have a BattleMech attempt to regain its feet after falling or dropping to the ground. Each attempt to stand costs 2 MP. A BattleMech may stand during the same turn that it fell, as long as it still has sufficient MP to make the attempt and was not jumping that turn. BattleMechs may only attempt to stand during the Movement Phase. A BattleMech may attempt to stand even if missing one leg or one or both arms.

If a BattleMech begins the Movement Phase prone, it must declare whether it will walk or run before it attempts to stand.

For a fallen BattleMech to stand up, the player must make a successful Piloting Skill Roll (see p. 22). If the attempt is not successful, the BattleMech falls again, taking falling damage. The unit may make repeated attempts to stand as long as it has Movement Points available.

Once the BattleMech successfully stands, it may face in any direction (at no cost), regardless of its facing while on the ground, and may either walk or run using any remaining Movement Points.

**Heat:** Each attempt to stand creates 1 point of heat.

**Minimum Movement:** A prone BattleMech with only 1 MP available at the beginning of its turn may make one attempt to stand using the *Minimum Movement* exception noted in *Movement Basics*, p. 17.

## STACKING

There is a limit to the number and type of units that may occupy a single hex. This limit is known as the stacking limit, and is defined as follows: At the end of each unit's movement, up to two units from each side may occupy a single hex. These units can consist of any combination of vehicles and infantry, but only one of the units in the hex can be a BattleMech. In other words, a maximum of 4 units may occupy a hex at the end of the Movement Phase (2 units from each force) by ending their movement in that hex, but only one of the 4 units may be a BattleMech.

During the Movement Phase, a unit may move through hexes occupied by other friendly units, but a unit may not move through a hex occupied by an enemy unit. Though it can enter a hex occupied by an enemy unit, it may not then leave that hex in the same phase of that turn. Regardless of these conditions, no unit may end its movement in a hex if that movement would violate the stacking limit.

It is important to note that while only one BattleMech can occupy a hex, it does not actually take up the entire hex. A 30-meter-wide hex offers plenty of room for a 12-meter-tall 'Mech to move around and avoid fire, and still allow up to three non-'Mech units to share the hex. Simply put, a BattleMech tactically controls the hex it occupies, but does not physically fill it.

**Infantry:** Infantry mounted on a vehicle and battlearmored troops riding on a BattleMech do not count against this stacking limit.

**Buildings:** These stacking rules do not apply to units in the same building on different levels. Within a building, apply these stacking limits to each level of the building.

**VTOLs:** These stacking limits do not apply to VTOL units occupying different elevation levels in the air. (See *VTOL Movement*, p. 54 in *Vehicles*.) Apply these stacking limits to each level of altitude within a hex.

**Submarines:** These stacking rules do not apply to submarine units occupying different depth levels in the water. Apply these stacking limits to each level of depth within a Water hex.

## ACCIDENTAL VIOLATION

If a unit inadvertently violates the stacking rules, the result is a fall as described in the *Domino Effect* rule, p. 45. The most common situation in which this will occur is when a unit moves into a hex with a friendly unit that has terrain that requires a Piloting Skill Roll, and the player fails the roll. If the unit that fell cannot manage to stand up and move out of the hex, a Domino Effect fall will result.

## PAVEMENT MOVEMENT

Pavement movement is handled in the same way as movement through Clear terrain, with a few important exceptions. Units may skid when moving on pavement, and roads may allow passage through prohibited or difficult terrain. Ground vehicles moving on pavement may be entitled to extra movement.

**Roads:** A road is simply a narrow strip of pavement that passes through terrain of some other type. All units traveling on roads pay only 1 MP per hex regardless of the hex's underlying

# MOVEMENT

terrain. A unit is considered to be traveling on a road if it moves from one hex to the next on that road. Units may move through prohibited terrain while traveling on a road, but they must begin and end their movement through such terrain on the road and remain on that road while traveling through the terrain. A unit traveling on a road must pay any elevation costs required for moving across the underlying terrain.

**Ground Vehicles:** Ground vehicles may receive a movement bonus of 1 additional MP for moving on pavement. To gain the extra MP, the unit must begin its turn on a Paved hex and continue to travel on pavement for the entire Movement Phase.

## BRIDGE MOVEMENT

Roads that cross a Water hex are considered bridges. Bridges are classified as Light, Medium, Heavy or Hardened in the same manner as buildings, and have the same range of Construction Factors (CF) as Light, Medium, Heavy and Hardened buildings (see *Buildings*, p. 49).

Bridges can be attacked like buildings. When a bridge's CF is reduced to 0, it has collapsed.

If the type of a bridge is not marked or defined by the scenario being played, assume it is a Medium Bridge with CF 40.

**Maximum Capacity:** In the same way as buildings, each hex of a bridge will only support units with a total tonnage equal to or less than the bridge's current CF. If the total tonnage of units in a Bridge hex exceeds the current CF of the bridge, the bridge collapses, and units on the bridge must take normal falling damage from the collapse of the bridge.

## SKIDDING

When a BattleMech or a ground vehicle is running (moving at flank speed) on a Paved surface (including a road or bridge), the unit may slip and lose control. There is a chance a unit will skid if it is running, makes one or more facing changes in a paved hex, and then intends to continue moving in that phase. Before the unit actually continues moving, the player must make a Piloting Skill Roll to see if the unit skids.

The player must make a Piloting Skill Roll (p. 22) modified by a factor based on the total number of hexes moved in the turn so far, using the Skid Modifier Table. If the die roll result equals or exceeds the unit's modified Piloting Skill, the running turn succeeds without mishap. If the result is less than the modified Piloting Skill target number, the BattleMech falls, suffering normal falling damage, and goes into a skid.

A unit skids for a number of hexes equal to the number of hexes it has moved in the turn so far divided by 2 (round up), continuing in the direction it was traveling before making the facing change that caused it to skid.

For every hex that a BattleMech skids, it suffers damage equal to one-half its normal falling damage, rounded up (see *Falling*, p. 22). Use the Front column of the BattleMech Hit

Location Table, p. 33 in *Combat*, to determine the location of this damage.

After a skid, the skidding unit's movement ends, even if it had MP remaining.

**Combat:** Add +2 to the to-hit number for all weapons fire and physical attacks made against a skidding unit during the turn in which it skids.

**Vehicles:** Vehicles that fail the Piloting Skill Roll do not fall down, but they lose control and go into a skid as described above. No damage occurs unless the vehicle hits something.

## Collisions

If an obstacle (a unit, or terrain or building that is higher than the terrain the skidding unit currently occupies) lies in the path of the skid, the skidding unit crashes into it.

In the case of hill terrain, there is no resulting damage and the skidding unit simply stops.

Units and buildings will take damage from a collision as if the skidding unit had executed a successful charge attack (see *Charge Attacks*, p. 41). The crash is resolved immediately, and, unlike normal charge attacks, can affect a unit that has not yet moved. Use the distance the unit moved before the skid to calculate damage. After the charge is resolved, the skid continues if the target unit or building was destroyed by the charge.

Otherwise, adjust both units' positions on the map as for a successful charge, and the skid ends.

**Avoiding a Collision:** A unit that has not yet moved during the current Movement Phase can attempt to get out of the way

of an oncoming skidding unit. In order to get out of the way, the unit must make a successful Piloting Skill Roll immediately before the skidding unit enters its hex. Success indicates the unit may make its entire movement immediately, before the skidding unit stops. Failure does not cause the unit to fall, but it remains in the hex where it was. Units moved in this way have expended their movement and may not move again later in the Movement Phase.

**Infantry:** Because they have no Piloting Skill, infantry units that have not yet moved can automatically move out of the way of a skidding unit. If a unit skids into an infantry unit, the infantry unit receives damage equal to the skidding unit's tonnage divided by 5, and the unit continues its skid even if the infantry unit survives.

*The BattleMech in Hex A wants to end its turn in Hex G. To spend the required 8 MP, this BattleMech must run. It runs to Hex C and makes a facing change toward Hex D. No Piloting Skill Roll is required. However, when the BattleMech declares a move into Hex D, still running, the player must make a Piloting Skill Roll before entering the hex because the BattleMech will be running after making a facing change. So far, the BattleMech has moved 2 hexes, and so the modifier for the Piloting Skill Roll is -1. The play-*

### SKID MODIFIER TABLE

Hexes Moved	Piloting Skill Modifier
0-2	-1
3-4	0
5-7	+1
8-10	+2
11+	+4

# MOVEMENT

er needs to roll a 4 or higher to avoid skidding. The player rolls a 10, and the BattleMech continues to run toward Hex G.

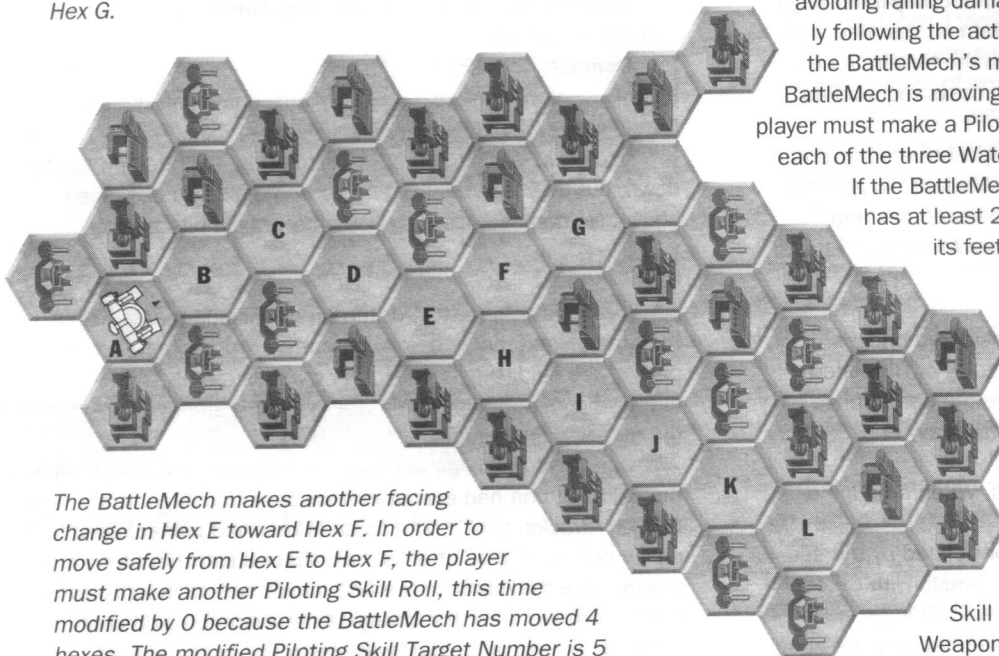

The BattleMech makes another facing change in Hex E toward Hex F. In order to move safely from Hex E to Hex F, the player must make another Piloting Skill Roll, this time modified by 0 because the BattleMech has moved 4 hexes. The modified Piloting Skill Target Number is 5 ( $5 + 0$ ). The player rolls a 4, which means the pilot failed to maintain control of the BattleMech, and his BattleMech skids down the E-K hex row. Because no obstructions block its path, the BattleMech will skid for 2 hexes ( $4 \div 2 = 2$ ). The BattleMech suffers 5 points of falling damage (50 tons divided by 10 is 5) and 3 points of damage per hex of the skid (half the falling damage of 5, rounded up) for a total of 11 ( $5 + 6$ ).

## PILOTING SKILL ROLLS

Players must make Piloting Skill Rolls for their MechWarriors under a variety of treacherous circumstances, usually to avoid falling. All of the events that require a Piloting Skill Roll are listed on the Piloting Skill Roll Table on p. 23.

**Vehicles:** Vehicle crews make Piloting Skill Rolls only to avoid skids and to avoid taking damage when entering buildings.

**Infantry:** Infantry units have no Piloting Skill and are never required to make Piloting Skill Rolls.

## MAKING PILOTING SKILL ROLLS

The Piloting Skill Roll Table lists the events that require a player to make a Piloting Skill Roll for his BattleMech's MechWarrior. Each time one of these events occurs, the player adds the following modifiers to his MechWarrior's Piloting Skill: all indicated modifiers for the event, plus additional modifiers from any other events taking place in the same phase, including those listed under Preexisting Damage on the Piloting Skill Roll Table. The resulting number is the Modified Piloting Skill.

To make the Piloting Skill Roll, the player rolls 2D6. If the result is equal to or greater than the Modified Piloting Skill, the BattleMech avoids falling. If the result is less than the Modified Piloting Skill, the BattleMech falls.

**Movement Phase:** Piloting Skill Rolls required because of movement (entering water, trying to stand up, entering rubble, avoiding falling damage, and so on) must be made immediately following the action. Multiple rolls may be required during the BattleMech's movement for a turn. For example, if a BattleMech is moving through 3 hexes of Depth 1 water, the player must make a Piloting Skill Roll when the BattleMech enters each of the three Water hexes.

If the BattleMech falls during the Movement Phase and has at least 2 MP remaining, it may attempt to regain its feet that turn.

**Weapon Attack Phase:** All Piloting Skill Rolls required because of weapons attacks must be made at the end of the Weapon Attack Phase of the turn. Note that a BattleMech only makes one Piloting Skill Roll for taking 20+ Damage Points in a single phase, regardless of how many points of damage over 20 it takes. All weapons attacks are resolved before the players make any required Piloting Skill Rolls. BattleMechs that fall during the Weapon Attack Phase begin the turn's Physical Attack Phase in a prone position.

**Physical Attack Phase:** All Piloting Skill Rolls required because of physical attacks are made at the end of the Physical Attack Phase. Resolve all physical attacks before making any Piloting Skill Rolls.

*During the Weapon Attack Phase, a BattleMech whose MechWarrior has a Piloting Skill of 5 takes 40 points of damage and loses 2 leg actuators. The player makes one Piloting Skill Roll for taking 20 or more points of damage, and two more for losing 2 leg actuators. The modified Piloting Skill Target Number for each of the three rolls is 8 [ $5$  (Piloting Skill) + 1 (20+ points of damage) + 1 (damaged leg actuator) + 1 (damaged leg actuator)].*

*During the Physical Attack Phase, the same BattleMech is kicked in the leg by two other BattleMechs, in the process losing another actuator and taking 23 more points of damage. The player must make four more Piloting Skill Rolls: two for being kicked twice, one for losing a leg actuator, and one for the 23 points of damage. The modified Piloting Skill Target Number for each of the four rolls is 9 [ $5$  (Piloting Skill) + 2 (existing actuator damage) + 1 (another damaged leg actuator) + 1 (20+ points of damage)].*

## FALLING

When a BattleMech falls, the machine will always suffer damage and its pilot may suffer damage. The amount of damage taken by the BattleMech depends on its weight and the distance it falls. Whether or not the MechWarrior suffers an injury depends on a Piloting Skill Roll.

# MOVEMENT

## PILOTING SKILL ROLL TABLE

### BattleMech's Situation

#### Damage to BattleMech

BattleMech takes 20+ Damage Points in one phase	+1
BattleMech reactor shuts down	+3 <sup>1</sup>
Leg/foot actuator destroyed	+1
Hip actuator destroyed	+2
Gyro hit	+3
Gyro destroyed	Automatic Fall
Leg destroyed	Automatic Fall

#### Physical Attacks on BattleMech

BattleMech was kicked	0
BattleMech was pushed	0
BattleMech was successfully charged/death from above attack	+2

#### Unit's Actions

BattleMech missed kick	0
BattleMech makes a successful charging attack	+2
BattleMech made death from above attack	+4 <sup>2</sup>
BattleMech entering Depth 1 Water hex	-1
BattleMech entering Depth 2 Water hex	0
BattleMech entering Depth 3+ Water hex	+1
BattleMech attempting to stand	0
BattleMech entering Rubble hex	0
Running unit moves after facing change while on pavement	See Skidding, below
Flanking VTOL moves after facing change	See <i>Sideslipping</i> , p. 55
BattleMech jumping with damaged gyro or leg/foot/hip actuators	per Preexisting Damage, below
BattleMech jumping with destroyed leg	per Preexisting Damage, below
BattleMech running with damaged hip or gyro	per Preexisting Damage, below

#### Special Case

MechWarrior trying to avoid damage when his BattleMech is falling	+1/level fallen
---	-----------------

### Preexisting Damage

Per leg/foot actuator previously destroyed	+1
Per hip actuator previously destroyed	+2
Gyro previously hit	+3
Leg previously destroyed	+5 <sup>4</sup>

### Skidding Movement

#### Hexes Moved in Turn

0-2	-1
3-4	0
5-7	+1
8-10	+2
11+	+4

### Building Movement<sup>3</sup>

Unit entering/leaving Light Building hex	0
Unit entering/leaving Medium Building hex	+1
Unit entering/leaving Heavy Building hex	+2
Unit entering/leaving Hardened Building hex	+5

#### Hexes Moved in Turn

1-2	0
3-4	+1
5-6	+2
7-9	+3
10+	+4

<sup>1</sup>Only during the turn that the reactor shuts down. If the MechWarrior must make a Piloting Skill Roll for a 'Mech with a shut-down reactor, the BattleMech automatically falls.

<sup>2</sup>Automatic fall if death from above attack is unsuccessful.

<sup>3</sup>To avoid damage only. Does not result in a fall if Piloting Skill Roll fails. See *Buildings*, p. 49. Add an additional modifier of 1 if unit is charging or being charged (in addition to the +2 modifier normally required in that situation).

<sup>4</sup>Do not add modifiers for other damaged actuators in the leg.

# MOVEMENT

## Determining Location After a Fall

To determine the location of a BattleMech after a fall, the players must use their judgment and the following guidelines to create a reasonable outcome. Location after a fall should be determined by the action that created the fall.

In general, when a BattleMech falls while moving from one elevation to another, the BattleMech will fall into the lower of the two hexes. If the fall occurs during the Movement Phase on level ground, the BattleMech falls in the hex it was entering. If a fall occurs because of weapons fire, a physical attack, or any other reason related to combat, the BattleMech falls in the hex it currently occupies.

To find the number of levels the BattleMech fell, subtract the elevation level of the hex into which the BattleMech fell from the elevation level of the hex from which it fell.

**Collisions:** If a BattleMech falls into a hex occupied by another BattleMech, the second BattleMech might also take damage, depending on how the BattleMech falls. If the BattleMech fell from a hex 2 or more elevation levels above the landing hex, use the *Accidental Falls from Above* rules, p. 45. If the BattleMech fell from a hex only 1 or 0 levels higher, use the *Domino Effect* rules, p. 45. If a BattleMech falls in a hex occupied by infantry and/or vehicles, the BattleMech misses any non-BattleMech units.

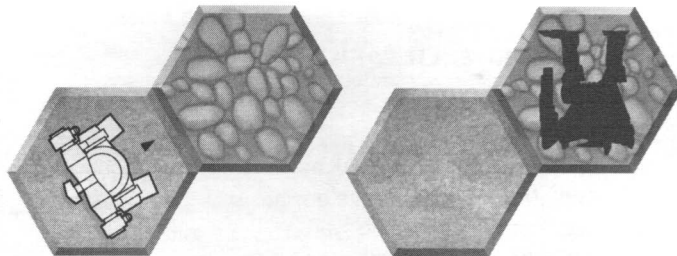

## Falling Damage to a BattleMech

A BattleMech always takes damage from a fall equal to 1 point for every 10 tons that the BattleMech weighs (rounding up) times the number of levels plus 1 that the BattleMech fell. If it fell into a Water hex, treat the Water hex as a Level 0 hex and apply only half the resulting damage (rounding up).

Divide the damage into clusters of 5 points each; in other words, form as many 5-point groups as possible, assigning any remaining points to one smaller group, and determine a hit location for each cluster. For example, a BattleMech that suffers 33 points of falling damage takes six clusters of 5-point hits and one 3-point hit. To determine the location of the damage, use the appropriate column of the BattleMech Hit Location Table, p. 33 in *Combat*, as specified by the Facing After a Fall Table.

If the fall occurs during the Movement Phase, resolve the damage as it happens.

## FACING AFTER A FALL TABLE

Die Roll (1D6)	New Facing	Hit Location
1	Same Direction	Front
2	1 Hexside Right	Right Side
3	2 Hexsides Right	Right Side
4	Opposite Direction	Rear
5	2 Hexsides Left	Left Side
6	1 Hexside Left	Left Side

## Facing After a Fall

When a BattleMech falls, it takes damage and its facing may change. This facing change determines the BattleMech Hit Location Table used when assigning damage from the fall.

To determine the unit's facing after the fall and the area of the BattleMech that takes damage from the fall, roll 1D6 and consult the Facing After a Fall Table.

A fallen BattleMech lies prone and face down. BattleMechs that fall on their sides or back automatically roll over to lie on their fronts after taking damage.

*The BattleMech in the diagram was entering a Rubble hex and failed its Piloting Skill Roll. The player rolls 1D6 with a result of 3 and consults the Facing After a Fall Table. The BattleMech is now facing 2 hexsides to the right (clockwise) of its original facing and takes the damage from the fall on its right side. It is now prone and face down in the Rubble hex.*

*A Grasshopper in a Level 1 hex attempts to stand during the Movement Phase. The MechWarrior fails his Piloting Skill Roll, and the BattleMech falls again into the same hex. The BattleMech fell from a Level 1 to a Level 1 hex (the same one) and so fell 0 levels. The player rolls a 1 on the Facing After a Fall Table and finds that the BattleMech landed on its face. It takes the falling damage on its front. The Grasshopper suffers 7 points of damage (70 tons divided by 10 is 7; the number of levels fallen plus 1 equals 1;  $7 \times 1 = 7$ ). These 7 points are divided into one cluster of 5 and one of 2. The player then uses the Front column of the BattleMech Hit Location Table to determine the location of the damage.*

## Falling Damage to the MechWarrior

To determine if the pilot took damage when the BattleMech fell, the player makes a second Piloting Skill Roll after every fall. First, apply all standard modifiers to the target number, then add an additional +1 to the MechWarrior's Piloting Skill target number for every level fallen. If the die roll result is equal to or greater than this modified Piloting Skill target number, then the MechWarrior avoided taking any damage. If the die roll result is less, the MechWarrior takes 1 point of damage.

## COMBAT

After the players complete the Movement Phase of the turn, units engage in combat. *BattleTech* units use two forms of combat: weapon attacks and physical attacks. Units make weapon attacks using armaments such as missiles, lasers and autocannons. For physical attacks, the BattleMechs use their own massive weight to inflict damage on targets.

In *BattleTech*, both weapon and physical attacks first inflict damage on the outer armor that protects every BattleMech and vehicle. When an attack or series of attacks destroys all of a location's Armor Points, any remaining damage affects the internal structure of the unit in that location. Every attack that damages a unit's internal structure may result in a critical hit that can knock out a weapon or movement system or even destroy the unit completely.

Most infantry units have no armor, so successful attacks against infantry reduce the number of troopers in the platoon rather than destroying Armor Points. Battle armor units absorb damage with Armor Points in the same way as vehicles, and an attacker may need to make multiple hits to destroy them.

Special combat rules for vehicles and infantry appear on pages 56 and 60, respectively. Unless specifically stated otherwise by those rules, the following rules apply equally to vehicles and infantry.

### ATTACK DECLARATION

As described in *Playing the Game* (p. 13), all attacks are declared before any are resolved. Only those weapon attacks that were declared during weapon attack declaration are resolved in the Weapon Attack Phase. Likewise, only those physical attacks declared during physical attack declaration are resolved in the Physical Attack Phase. All attacks that are declared must be resolved, even if the intended target is destroyed before all attacks against it have been made (though an attack may be aborted if the Modified To-Hit Number is greater than 12; see *Modified To-Hit Number*, p. 29). Likewise, attacks that were not declared cannot be made, even if the opportunity presents itself during the course of play.

### TORSO TWIST/TURRET ROTATION

As part of each unit's weapon attack declaration, the players can twist the torsos of their BattleMechs or rotate the turrets of any turreted vehicles or buildings. This twist or rotation lasts for the remainder of the turn, affecting firing arcs for both the Weapon Attack and Physical Attack Phases. The torso or turret returns to its forward position in the End Phase.

**BattleMechs:** A BattleMech can twist its torso one hexside (60 degrees) to the left or right of the direction in which its feet are pointing. This new alignment modifies a BattleMech's upper body firing arc as described in *Firing Arcs*, p. 27, but for movement and hit location purposes, the BattleMech is still considered to be facing in its pre-twist direction.

**Vehicles:** Vehicles with turrets may align the turrets to any hexside. Rotating its turret modifies a vehicle's firing arc as described in *Firing Arcs*, p. 27.

### LINE OF SIGHT

In order to make an attack against a target, there must be a clear line of sight (LOS) between the attacker and the intended target. The LOS between two units is defined by a straight line running from the center of the attacking unit's hex to the center of the target unit's hex. Any hexes that this line passes through are along the LOS, even if the line barely crosses a hex. If the LOS passes exactly between two hexes, it is up to the player of the targeted unit to decide which of the two hexes the LOS passes through.

The hexes containing the attacking and target units are not considered in determining LOS, and they never intervene or interfere with LOS in any way (however, see *Water Hexes*, p. 27 and *Underwater Operations*, p. 88 for an exception to this rule).

**Adjacent Units:** Units in adjacent hexes always have LOS to each other. However, if a unit is underwater and a unit in an adjacent hex is not, see *Underwater Operations*, p. 88 for an exception to this rule.

### ELEVATION

A hex's elevation is marked on the map. Hexes with elevations higher than 0 are also referred to as hills. Hexes with elevations lower than 0 are also referred to as sinkholes. All affect LOS in the same way. Hexes whose elevation cannot be determined should be assumed to be Level 0.

**Woods:** Woods rise 2 levels above the elevation of the hex they are in. Units occupying Woods hexes are standing on the underlying terrain, not on top of the trees (see *VTOL Movement* for an exception, p. 54).

**Buildings:** Buildings rise above the hex they occupy for a number of levels equal to the level listed for the building.

**Water:** Water hexes descend to a specific Depth level, but the surface of the water is actually at Level 0. The Depth is the level of the bottom of the body of water, not its surface. This means that water intervenes for purposes of line of sight as if it is at Level 0, while a BattleMech in the water stands on the bottom, at the Depth level of the hex.

**Units:** Standing BattleMechs rise 1 level above the elevation of the hex they are in for purposes of LOS. Prone BattleMechs have the same elevation as the hex they are in, as do other types of ground units. VTOLs add their altitude in levels to the elevation, while submerged submarines subtract their depth from the surface elevation of the water (normally Level 0).

### INTERVENING TERRAIN

Terrain along the LOS between the attacker and the target that is actually in the LOS (not including the hexes occupied by the attacker and target) is called *intervening* terrain. The terrain of the hexes along the LOS between the attacker and target may

or may not intervene in LOS, depending on its elevation relative to the attacker and target. Likewise, features of the terrain in the hexes along the LOS between the attacker and target (buildings, water, woods, and so on) may or may not actually intervene in LOS, depending on their elevation relative to the attacker and target. Only features of the terrain that have elevations, such as trees and buildings, can actually intervene in LOS. For example, rubble would not be intervening, though the hex containing the rubble might be.

Use the following guidelines to determine if terrain is intervening.

Terrain along the LOS between two units is intervening if:

- the terrain or terrain feature is higher than both units, or
- the terrain or terrain feature is adjacent to the attacker and higher than the attacker, or
- the terrain or terrain feature is adjacent to the target and higher than the target.

## Effects of Intervening Terrain

Intervening terrain has the following effects on LOS.

**Hills:** Intervening elevation levels (hills) block LOS.

**Buildings:** Intervening buildings block LOS.

**Light Woods:** Three or more hexes of intervening Light Woods block LOS. One hex of intervening Light Woods combined with one or more hexes of intervening Heavy Woods will also block LOS.

**Heavy Woods:** Two or more hexes of intervening Heavy Woods block LOS. One hex of intervening Heavy Woods combined with one or more hexes of intervening Light Woods will also block LOS.

**Water:** Intervening water blocks LOS unless both the attacker and target are completely submerged and no other terrain intervenes. See also *Water Hexes*, p. 27, *Underwater Operations*, p. 88 and *Partial Cover*, p. 26.

**Units:** Intervening units have no effect on LOS or attacks.

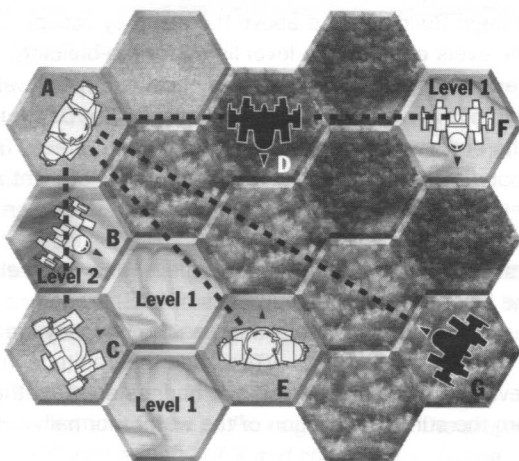

The diagram above illustrates some of the principles governing line of sight. The BattleMech in Hex A wants to make an attack this turn. It is standing in a Level 0 hex, therefore it is considered to be at Level 1

for purposes of LOS. Checking LOS for the BattleMech in Hex A to the other 'Mechs shown, we find the following conditions:

'Mech A has clear LOS to the 'Mech in Hex B, because the Level 2 hill in the hex occupied by the target does not apply when checking LOS. Line of sight to the 'Mech in Hex C is blocked by that same hill, however, because it is intervening and higher than both the attacker and the target.

LOS to the 'Mech in Hex D passes directly between a Clear hex and a Light Woods hex. The target player chooses for the LOS to be affected by the light woods. This choice does not block LOS, however, because the heavy woods in the target hex are not intervening, and therefore have no effect on LOS.

LOS to the 'Mech in Hex E passes through a Level 1 hill and one hex of light woods, so it is not blocked.

The 'Mech in Hex F is standing on a Level 1 hill, making its total elevation Level 2. None of the woods between the units in Hexes A and F are higher than both units. The light woods adjacent to Hex A are higher than the 'Mech in Hex A, so those woods are intervening. The heavy woods adjacent to Hex F are not higher than the 'Mech in Hex F, so those woods are not intervening. This means only one hex of Light Woods intervenes, so there is a clear LOS between the units.

The LOS to the 'Mech in Hex G is blocked because there are three Light Woods hexes intervening.

You can use the diagram to practice finding LOS with the other units. Try to determine how many targets each unit can see, and compare your results to the correct results that follow: Hex B has 6 targets, Hex C has 5 targets, Hex D has 5 targets, Hex E has 6 targets, Hex F has 6 targets, and Hex G has 4 targets.

## PARTIAL COVER

Only a standing BattleMech can receive partial cover from terrain. To receive partial cover, a BattleMech must be adjacent to a hex of equal elevation to itself, and that hex must lie between it and the attacking unit. For example, a 'Mech standing on Level 0 terrain has an Elevation Level of 1 for determining LOS. An adjacent hex of Level 1 terrain lying between the attacker and the target would provide partial cover. In addition, the firing unit must also have an elevation level equal to or lower than the defending unit in order for the target to receive partial cover. In other words, an attacker firing downhill negates its target's partial cover.

The intervening elevation can be a hill, building, or combination of both. A BattleMech does not receive partial cover from woods. Partial cover does not block LOS, but it adds a +3 modifier to the attacker's to-hit number. Use the BattleMech Punch Location Table (p. 39) to determine the location of damage inflicted on a partially concealed target. (See *To-Hit Modifiers*, p. 29, for further explanation.)

## WATER HEXES

A Depth 1 Water hex provides partial cover for a standing BattleMech occupying that hex. Because the water surrounds the 'Mech, the partial cover applies even if the attacker is at a higher elevation than the target. Depth 2 or deeper water completely blocks LOS to and from the BattleMech standing in that hex, while LOS is blocked to a prone 'Mech in Depth 1 or deeper water.

**Vehicles:** Hovercraft moving over water and surface naval vessels are at Level 0. Submarines can be at any level on or under the water (see *Underwater Operations*, p. 88). Other types of vehicles cannot enter Water hexes.

**Underwater Attacks:** There are special-case rules that apply to attacks that travel through water. See *Underwater Operations*, p. 88.

The diagram at right illustrates some examples of partial cover. BattleMechs C and D have partial cover from BattleMech A because each is adjacent to a hex with elevation equal to its own elevation along the LOS from BattleMech A. BattleMech A has no LOS to 'Mech B because it is standing in Depth 1 water, making the Level 1 hill higher than its elevation.

No BattleMechs have partial cover from 'Mech B, though LOS is blocked to 'Mech A.

Only 'Mech B has partial cover from 'Mech D. Though there is a Level 2 hill adjacent to 'Mech C along the LOS, it doesn't provide partial cover because 'Mech B has a higher elevation than 'Mech C. Since 'Mech B is in water, it has partial cover against 'Mech D even though 'Mech D is uphill.

The 'Mechs in Hexes B and D have partial cover from the 'Mech in Hex C. Even though 'Mech B is lower than 'Mech C, the water still provides partial cover.

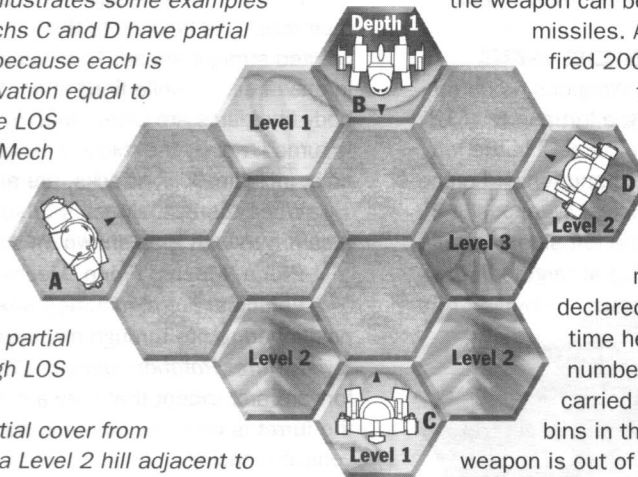

If the attack hits the target, the attacking player determines the damage location, and the target player records the result on the damaged unit's record sheet.

Note that the rules for weapon attacks provide general rules for firing arcs, inflicting damage, and critical hits. These rules also apply to physical attacks (p. 39).

## AMMUNITION EXPENDITURE

BattleMechs carry a limited amount of ammunition for missile launchers, machine guns, autocannons and other ballistic and missile weapons. Weapons that require ammunition indicate the number of shots available for that weapon in the Ammo column of the Weapons and Equipment Tables (p. 115). Note that a "shot" in this case represents a single use of the weapon, not a single missile or round of ammunition. For example, an LRM-20 with one ton of ammo has six shots, so the weapon can be fired six times, each shot launching twenty missiles. A machine gun with a ton of ammo can be fired 200 times. Every time one of these weapons is fired, a shot of ammo is expended.

The record sheet for each unit indicates the available number of shots for each weapon in the Weapons Inventory. The player should keep a tally of shots fired using the Critical Hit Table, making a hash mark (when the attack is declared) next to the appropriate ammo slot every time he fires the corresponding weapon. When the number of marks equals the amount of ammo carried in that slot, that bin is empty. If no other bins in the BattleMech carry that type of ammo, the weapon is out of ammunition and cannot be fired for the rest of the game. Each weapon can draw ammo from any ammo bin that carries the exact same type of ammunition. The ammo need not be carried in the same location as the weapon. For example, an LRM -15 in the left arm could use LRM 15 ammo carried in any location, but could not use LRM 5, 10, or 20 ammo.

**Infantry:** Infantry units do not need to keep track of ammunition, with the exception of certain battle armor missile attacks (see *Battle Armor Attacks*, p. 61).

## WEAPON ATTACKS

During the Weapon Attack Phase, players use their units' armaments to attempt to inflict damage on targets. For one unit to fire at another, the attacking unit must have a clear line of sight to the target, and the target must be within the range and firing arc of the weapons the attacking player wishes to use. The attacking player then calculates the likelihood of a shot hitting the target based on the range to the target, movement of the target and attacker, intervening terrain, and other factors.

Players fire each weapon on a unit individually, and can fire as many or as few of their unit's weapons at the target as they wish, within the restrictions described below. Unless otherwise stated in the rules, each weapon may be fired only once per turn.

## FIRING ARCS

If an attacking unit has LOS to its intended target, the attacking player can then check the firing arcs of his unit's weapons to see which weapons can hit the target. There are four firing arcs: the forward arc, left side arc, right side arc, and rear arc. The following diagrams illustrate the boundaries for each arc. To determine the exact boundaries of the forward, left side and right side firing arcs, draw straight lines from the firing unit through Hexes A and B, as shown in the appropriate diagram. The firing arc includes the hexes between the two lines, as well as the hexes through which these lines pass.

(Note that the following firing arcs extend from the firing unit to the edge of the playing area. The maximum ranges for different weapons are described in the Weapons and Equipment Tables, beginning on p. 115 in *Construction*).

**Infantry:** Infantry do not have firing arc restrictions.

## FORWARD ARC

Weapons mounted in the three forward torso locations, the legs, or the head of a BattleMech may fire only at targets in the forward arc. Arm-mounted weapons may fire into the forward arc plus the appropriate side arc.

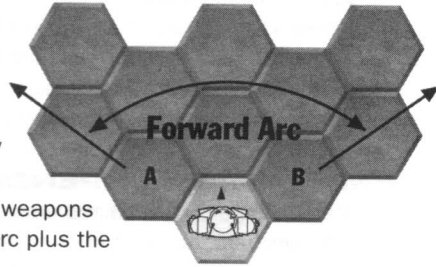

**Leg-Mounted Weapons:** Leg-mounted weapons may not fire through a hex that provides the firing 'Mech with partial cover.

**Vehicles:** Weapons mounted on the front location of vehicles may only fire into the front arc. Weapons mounted in the turret can also fire into the forward arc, though this firing arc can be rotated as described in *Rotating the Firing Arcs*, p. 28.

**Leg-Mounted Weapons:** Leg-mounted weapons may not fire through a hex that provides the firing 'Mech with partial cover.

**Vehicles:** Weapons mounted on the rear of vehicles may only fire at targets in the rear arc.

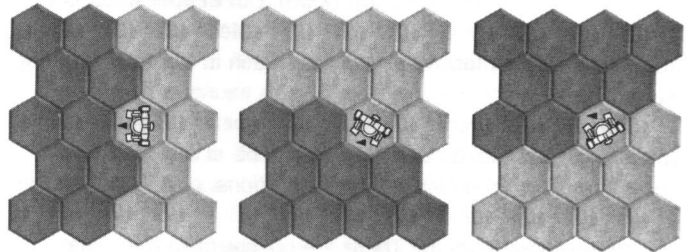

Torso Forward

Torso Twisted Left

Torso Twisted Right

## ROTATING THE FIRING ARCS

During weapon attack declaration, BattleMechs can rotate their torso one hexside to the left or right while keeping their feet pointed straight ahead. This means that a BattleMech can move in one direction while firing in another. A BattleMech's upper-body firing arcs are determined by the direction in which its torso is turned, not by the 'Mech's facing; leg-mounted weapon firing arcs, including kick attacks, are always aligned with the feet.

When the BattleMech's torso rotates, all upper-body firing arcs rotate with it as shown on the diagram.

**Prone 'Mechs:** Prone 'Mechs may not twist their torsos.

**Vehicles:** Turret-mounted weapons in vehicles can be positioned to fire through any hexside, per the *Torso Twist/Turret Rotation rules*, p. 25. Treat turret arcs as the forward arc, except that they are defined by the hexside at which the turret is currently pointing, not the hexside toward which the vehicle is facing.

## FIRING WEAPONS

After a player has determined that a target is within LOS and has determined the firing arc of his weapons, the unit may make a weapon attack. The player counts the range in hexes to the target to determine the base to-hit number for the attack. For each weapon he will fire, the player determines if the shot is more or less difficult than normal by factoring in terrain, movement, and other conditions. These factors will add modifiers to the base to-hit number to create a modified to-hit number. The more difficult the shot is because of distance, concealment by terrain, or movement, the higher the modified to-hit number. The player then rolls 2D6 to see if the attack hits the target. If the result is equal to or greater than the modified to-hit number, the attack hits its target. If the fired weapon requires ammunition, the player marks off one shot of ammunition.

Each weapon may be fired only once per turn.

A unit cannot make a weapon attack against another unit occupying the same hex as the attacker. (See *Infantry* for exceptions.)

## BASE TO-HIT NUMBER

The base to-hit number for a weapon attack is equal to the firing unit's Gunnery Skill Level.

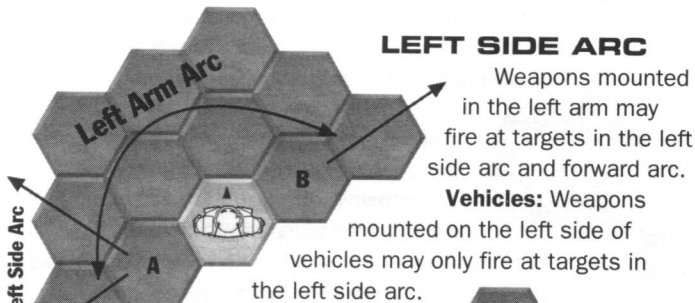

## LEFT SIDE ARC

Weapons mounted in the left arm may fire at targets in the left side arc and forward arc.

**Vehicles:** Weapons mounted on the left side of vehicles may only fire at targets in the left side arc.

## RIGHT SIDE ARC

Weapons mounted in the right arm may fire at targets in the right side arc and forward arc.

**Vehicles:** Weapons mounted on the right side of vehicles may only fire at targets in the right side arc.

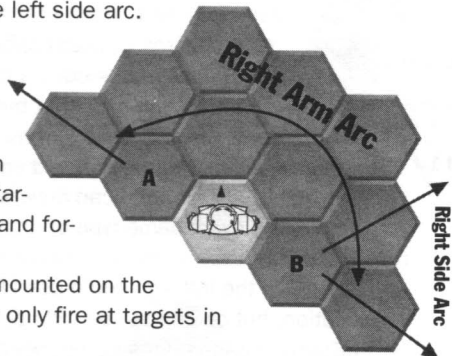

## REAR ARC

Weapons mounted in any of the three rear torso locations may only fire into the rear arc. Weapons may also be rear-mounted on the head and legs. All rear-mounted weapons are indicated by an (R) on a 'Mech's record sheet and may only fire at targets in the rear firing arc.

To determine the boundaries of a 'Mech's rear arc, draw a straight line starting in Hex A and passing through Hex B, and another line starting in Hex A and passing through Hex C on the Rear Arc Diagram. The rear firing arc includes the hexes between the two lines, as well as the hexes through which these lines pass.

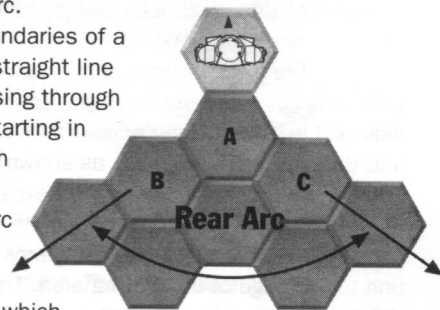

## MODIFIED TO-HIT NUMBER

The modified to-hit number equals the base to-hit number plus all modifiers for range, minimum range, movement, terrain, and other factors discussed in *To-Hit Modifiers*, below. If the modified to-hit number is greater than 12, the shot automatically misses. If a player determines that his unit's declared attack will automatically miss, he can choose not to make the attack, thereby avoiding wasting the ammunition and building up heat. He may not switch his attack to another target.

## TO-HIT MODIFIERS

The base to-hit number may be modified by a number of factors, including range, terrain, movement, multiple targets, heat and damage, and prone and immobile targets. All modifiers are cumulative.

### Range Modifier

The farther away the target is from the firing unit, the more difficult it will be to hit. The range modifier for an attack is determined by the range to the target, which is the distance between the attacking unit and its target. To determine range, find the shortest path to the target and count the hexes between the attacker and the target, starting with the hex adjacent to the attacker's hex along the line of sight and including the target's hex. This total number of hexes between attacker and target is the range.

The ranges for all available weapons appear in the Weapons and Equipment Tables, beginning on p. 115 in *Construction*. A weapon's maximum range is divided into three distances: short, medium and long. Find the distance to the target in the row for the appropriate weapon, and determine if the unit's current range is short, medium, long, or out of range. A shot at short range requires no to-hit modifier. A medium range shot has a +2 to-hit modifier, while a shot at long range has a +4 modifier.

Weapons cannot hit a target at a distance greater than the weapon's long range, but units may fire at targets beyond long range just to get rid of ammunition.

### Minimum Range Modifier

Some weapons, such as particle projector cannons, autocannons and long-range missiles (LRMs), are designed to be fired at long-range targets. When fired at close-range targets, they lose much of their effectiveness. The minimum effective range of each available weapon, the range at which the weapon becomes less effective than normal, appears in the Weapons and Equipment Tables, p. 115.

If the target occupies the hex indicated as the minimum effective range, modify the to-hit number by +1. For every hex closer to the attacker, add an additional +1 to the to-hit number. This represents the fact that it is harder to hit targets with some weapons at very close ranges than at maximum range.

*A particle projector cannon (PPC) has a minimum effective range of 3 hexes. If a Banshee is firing a PPC at a Dragon 3 hexes away, it adds a Minimum Range*

*Modifier of +1 to its to-hit number. If the Dragon is only 2 hexes away, the modifier is +2. If the target is 1 hex away, the modifier is +3. The diagram below shows the base to-hit numbers for a PPC as modified for range and minimum range, assuming a Gunnery Skill of 4.*



If the 'Mech in the above example allows its target to move to within 2 hexes of its position, the player must modify the BattleMech's to-hit number because the target stands inside its weapon's minimum effective range. The Base To-Hit Number is 4 because the MechWarrior's Gunnery Skill Level is 4, and the Minimum Range Modifier is +2. This gives the attacking 'Mech a Modified To-Hit Number of 6, the same as if the target were at medium range.

### Attacker Movement

A moving attacker must constantly adjust his aim to compensate for his movement, so an attacking unit's to hit number is modified by its own movement using the values in the Attack Modifiers Table. The attacker movement modifier is based on the movement mode the attacking unit used in the turn, regardless of the actual MP or distance moved.

**Infantry:** Infantry is not subject to a movement modifier for attacking.

### Target Movement

A moving target is harder to hit, and so an attacking unit's to-hit number is also modified by its target's movement using the values in the Attack Modifiers Table. The target movement modifiers are based on the hexes traversed rather than the number of Movement Points spent. If the target moved both backward and forward in the turn, base the movement modifier on the number of hexes moved from the hex in which the unit last reversed its movement. For example, if the target moved backward 3 hexes and then forward 2 hexes, the target movement modifier would be based only on the final 2 hexes of movement, resulting in a Target Movement Modifier of 0. Note that if the target jumped in the current turn, the player must add a jump modifier in addition to the modifier for the number of hexes moved.

*The diagram on the next page illustrates the modifiers to the to-hit number that we have discussed so far. The Jenner has used its Walking movement of 7 MP to move from Hex A to Hex B. Though it expended 7 MP in the move, it actually traveled 5 hexes as shown. The JagerMech had to use running movement to get from Hex C to Hex D facing the Jenner. It spent a total of 5 MP but only traveled 2 hexes. Finally, the Atlas did not move, and remained standing in Hex E. All of the 'Mechs have standard Gunnery Skills of 4.*

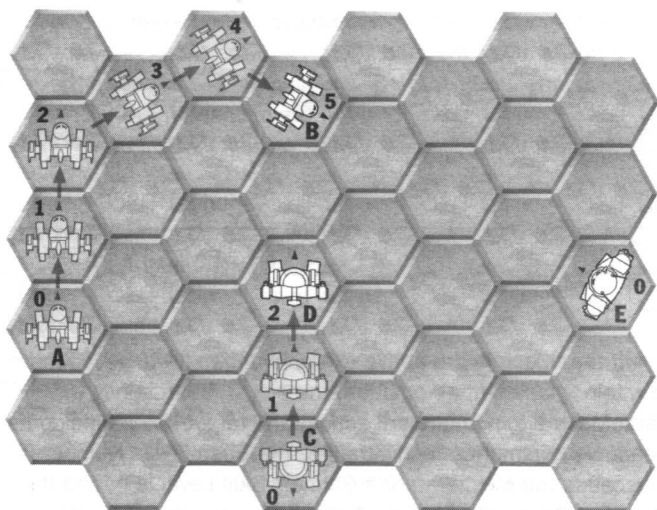

The Jenner is firing four medium lasers at the Atlas. The target is 4 hexes away, which is in the medium range for the lasers, adding a Range Modifier of +2. The Jenner used Walking movement this turn, so the Attacker Movement Modifier is +1. The target did not move. The Base To-Hit Number is 4, so the Modified To-Hit Number is 7 (Base 4 + Range 2 + Attacker Movement 1 = 7).

The JagerMech is attacking the Jenner with its AC/5s. The JagerMech used Running movement this turn, so it must add an Attacker Movement Modifier of +2 to its to-hit number. The target traveled 5 hexes, so there is a Target Movement Modifier of +2. The range to the target is 2 hexes, which is in short range for the AC/5s. However, the AC/5 has a minimum range of 3. This means an attack at a range of 3 would be modified by +1, while an attack made at 2 hexes range—such as this attack—is modified by +2. The Modified To-Hit Number for the JagerMech's AC/5s is 10 (Base 4 + Attacker Movement 2 + Target Movement 2 + Minimum Range 2 = 10).

The Atlas is launching its LRMs at the JagerMech. The range to the target is 4 hexes, which is short range for that weapon, but the LRMs have a minimum range of 6. This means there is a Minimum Range Modifier of +3 applied to the attack. The Atlas did not move, so no attacker movement modifier is applied. The JagerMech spent 5 MP running, but only traveled 2 hexes, so there is also no target movement modifier applied. The Modified To-Hit Number for the LRM attack is 7 (Base 4 + Minimum Range 3 = 7).

## Terrain Modifiers

Terrain can affect the probability of a successful shot by forcing the attacker to account for intervening land features and partial cover. Specific terrain modifiers appear below.

**Light Woods:** Add a terrain modifier of +1 if the target occupies a Light Woods hex. Additionally, modify the to-hit number by +1 per hex of Light Woods intervening between the attacker and

the target. (The woods must be intervening as defined in *Line of Sight*, p. 25. If the treetops lie below the LOS between the units, do not apply this modifier.)

**Heavy Woods:** Add a terrain modifier of +2 if the target occupies a Heavy Woods hex. Additionally, modify the to-hit number by +2 per hex of Heavy Woods intervening between the attacker and its target. (The woods must be intervening as defined in *Line of Sight*, p. 25. If the treetops lie below the LOS between the units, do not apply this modifier.) Note that if more than 1 Heavy Woods hex intervenes between the attacker and the target, LOS is blocked.

**Water:** Units in Water hexes find movement difficult, which limits their ability to avoid incoming attacks and launch effective attacks of their own. Add a terrain modifier of +1 to the to-hit number if the attacker is in a Water hex of Depth 1 or deeper. Modify the to-hit number by -1 if the target occupies a Water hex of Depth 1 or deeper. Because a BattleMech also receives a +3 partial cover modifier for standing in a Depth 1 Water hex, it would have a total terrain modifier of +2.

Water of Depth 0 has no effect on the to-hit number.

A BattleMech standing in a Depth 2 (or deeper) Water hex, or lying prone in a Depth 1 (or deeper) Water hex, cannot fire on or be fired on by other units. See *Underwater Operations*, p. 88, for exceptions.

Hovercraft moving over water are considered to be at Depth 0 regardless of the actual depth of the Water hex they occupy.

**Partial Cover:** Partial cover only applies to standing BattleMechs. Add a terrain modifier of +3 to the to-hit number if the target BattleMech is partially concealed (see *Line of Sight*, p. 25). When a BattleMech receives the partial cover modifier, resolve damage from those attacks on the BattleMech Punch Location Table, p. 39.

## Multiple Targets Modifier

A player may declare that his BattleMech or vehicle will engage more than one target in a turn and allocate different weapon systems to fire at different targets.

The player designates one of the targets as the primary target. If any of the declared targets are in the attacker's forward arc, one of those targets must be the primary target. If the attacker is declaring attacks only against targets in the side and rear arcs, any target may be chosen as the primary target. The remaining targets are considered secondary targets, and the player must add a multiple targets modifier to the to-hit numbers for those attacks. Against secondary targets in the forward arc, the modifier is +1; against secondary targets in the side and rear arcs, the modifier is +2. This modifier is not cumulative—the modifier for the third and each subsequent target is still only +1 (or +2).

**Physical Attacks:** This multiple targets modifier does not apply to physical attacks in any way.

**Infantry:** Infantry may only engage one target per turn.

## Heat and Damage Modifiers

The attacking BattleMech may be forced to modify its base to-hit number for current combat damage and heat buildup.

# COMBAT

Modifiers for these conditions are discussed in *BattleMech Critical Hits*, p. 35, and *Building Up Heat*, p. 46. The Heat Scale section of the record sheets summarizes the modifiers for the effects of heat buildup.

**Lower Arm Actuator:** Certain 'Mechs are designed without lower arm actuators in one or both arms. Such 'Mechs do not suffer the modifier to weapon attacks because they do not include that actuator, though the missing actuator still affects physical attacks.

## Firing at Immobile Targets

If a unit chooses to fire at an immobile target such as a building, a wooded hex, or a unit that is shut down or whose crew is unconscious, add a -4 modifier to the to-hit number. Note that this modifier does not apply to attacks against active units that are simply remaining stationary, nor does it apply to prone BattleMechs or 'Mechs with destroyed gyros or two destroyed hip actuators. Such units are still assumed to be moving within their hex and must be fired upon as for a normal target.

**Aimed Shots:** Attacks against immobile targets may be aimed at specific hit locations. For rules regarding this kind of attack, see p. 33.

## PRONE BATTLEMECHS

Prone BattleMechs may still make weapons attacks, and, because they are largely stationary, they often make better targets.

## Firing When Down

A BattleMech that has fallen or dropped to the ground may fire some of its weapons as long as neither of its arms has been destroyed. The pilot uses one arm to support the BattleMech as it fires, so the weapons on that arm cannot fire. The pilot may fire all the weapons mounted on the other arm, and the BattleMech may fire any weapons mounted in its head or torso. A prone BattleMech may not fire its leg-mounted weapons. Add a +2 to-hit modifier for firing when down.

## Attacking Prone Targets

A BattleMech that has fallen or is prone makes an easier target for an opponent in an adjacent hex and a more difficult target at longer ranges. Apply a -2 modifier to the to-hit number of any physical or weapon attack made against a prone BattleMech from an adjacent hex. Add a +1 to-hit modifier for all other attacks made against a prone 'Mech.

## TO-HIT ROLL

For each attack, the player makes a to-hit roll by rolling 2D6. If the result is equal to or greater than the modified to-hit number, the attack succeeds.

## Missile Hits

When a player launches a missile attack, the damage inflicted by a hit (a successful attack) depends on how many of the fired missiles actually reached the target.

To make a missile attack, the player calculates the modified to-hit number and makes the to-hit roll, just as for other weapons. On a successful attack, the player must also determine how many of the missiles hit the target by rolling 2D6 and consulting the Missile Hits Table.

First, find the number of missiles fired on the top row of the table. Cross-refer this number to the die-roll result in the left column. The result is the number of missiles that actually hit the target. Note that some advanced weapon systems modify this roll to reflect their greater accuracy. Also, the target's anti-missile systems may reduce the number of missiles that actually hit. See *Equipment*, p. 122, for details.

*An Atlas fires its 20-pack long-range missile launcher and hits its target. The attack is successful, and the attacking player must now determine how many of his 20 missiles actually hit the target. He rolls 2D6 with a result of 8. He finds that number in the left-hand column of the Missile Hits Table, then reads across the row to the 20 missiles column, which shows that 12 of his missiles reached their target.*

**MISSILE HITS TABLE**

Die Roll (2D6)	Number of Missiles Fired									
	2	3	4	5	6	9	10	12	15	20
2	1	1	1	1	2	3	3	4	5	6
3	1	1	2	2	2	3	3	4	5	6
4	1	1	2	2	3	4	4	5	6	9
5	1	2	2	3	3	5	6	8	9	12
6	1	2	2	3	4	5	6	8	9	12
7	1	2	3	3	4	5	6	8	9	12
8	2	2	3	3	4	5	6	8	9	12
9	2	2	3	4	5	7	8	10	12	16
10	2	3	3	4	5	7	8	10	12	16
11	2	3	4	5	6	9	10	12	15	20
12	2	3	4	5	6	9	10	12	15	20

## HIT LOCATION

When an attack hits its target, the firing player must determine precisely where the attack hit the target. Hit location is determined by the direction of the attack and the facing of the target.

## Attack Direction

When an attack hits a BattleMech or vehicle, it hits from either the front, rear, left, or right side of the target.

Lay a straightedge from the center of the attacker's hex to the center of the target's hex. Compare the hexside crossed by the straightedge to the diagram on page 33 to find the side of the unit hit by the fire.

If the straightedge crosses exactly at the intersection of two sides, the target chooses which side is hit by the attack.

## ATTACK MODIFIERS TABLE

### All Attacks: Weapons and Physical

Attacker	Modifier
Movement*	
Stationary	None
Walked	+1
Ran	+2
Jumped	+3
Prone	+2
<b>Terrain</b>	
Light Woods	+1 per intervening hex; +1 if target in Light Woods
Heavy Woods	+2 per intervening hex; +2 if target in Heavy Woods
Water**	
Depth 1	-1 to hit a BattleMech in Water hex; Partial Cover also applies
Depth 2	+1 to hit for BattleMech firing from Water hex
Partial Cover	BattleMechs cannot fire into or out of Depth 2+ water
	+3 (use BattleMech Punch Location Table)
<b>Target</b>	
Prone	-2 from adjacent hex; +1 from all others
Immobile	-4
Skidding	+2
<b>Movement</b>	
Moved 0-2 hexes	0
Moved 3-4 hexes	+1
Moved 5-6 hexes	+2
Moved 7-9 hexes	+3
Moved 10+ hexes	+4
Jumped	+1 additional
Is battle armor unit	+1
Is stuck in Swamp hex	-2

### Weapon Attacks Only

<b>Attacker</b>	
BattleMech Damage	
Sensor Hit	+2
Shoulder Hit	+4 for weapons in arm, disregard other damaged actuators in arm
Upper or Lower Arm Actuator (each)	+1 for weapons in arm
<b>Heat</b>	
0-7	None
8-12	+1
13-16	+2
17-23	+3
24+	+4
Making indirect LRM attack	+1
<b>Range and Terrain</b>	
<b>Range</b>	
Short	None
Medium	+2
Long	+4
Minimum Range	+1 at minimum range, additional +1 per hex less than minimum range
Attacker and target on different levels of same building (concealment)	+3
<b>Target</b>	
Secondary target in forward arc	+1
Secondary target in side or rear arc	+2

### Physical Attacks Only

<b>Attacker</b>	
BattleMech Damage	
Shoulder Hit	No punching or hatchet/sword attack with arm; no clubbing attacks; +2 to pushing attack (each)
Upper or Lower Arm Actuator Hit (each)	+2 to punching and hatchet/sword attack with arm; half damage for punching attack with arm; +2 to clubbing attacks
Hand Actuator Hit	+1 to punching attack with arm; no clubbing attacks; no hatchet/sword attacks with arm
Hip Actuator Hit	No kicking attacks
Upper or Lower Leg Actuator Hit (each)	+2 and half damage to kicking attack with leg
Foot Actuator Hit	+1 to kicking attack with leg
<b>Target</b>	
Infantry	+3 to kicking and death from above attacks
<b>Other Modifiers</b>	
Charging attack	Modify for relative Piloting Skills (p. 41)
Death from Above attack	Modify for relative Piloting Skills (p. 42)

\* Does not apply to infantry units.  
 \*\* See *Underwater Operations*, p. 88 for exceptions.

To determine which side of a BattleMech is hit, use the facing of a standing BattleMech's feet to determine its front side, regardless of torso twist. If the target BattleMech is prone, use the hexside toward which its head is pointing as its facing.

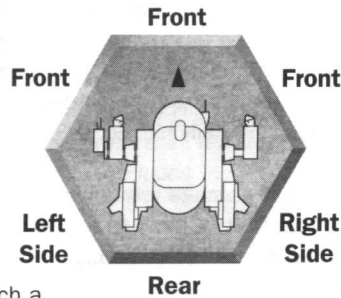

**Vehicles:** The side on which a vehicle is hit is based on the alignment of its front side.

**Infantry and Buildings:** Hits on infantry and buildings do not rely on the direction of the attack. Players who make a successful attack against these targets need not determine attack direction or hit location. Detailed explanations for assigning damage to infantry and buildings appear in their respective sections.

The Atlas from the previous example hits its target with an LRM 20 and inflicts 12 points of damage. The straightedge shows that the attack strikes the target's left side. Because the attack is an LRM attack, the damage is divided into 5-point groups. In this case, the attack hits in two groups of 5 points of damage, plus one group of 2 points of damage. The attacking player rolls to determine hit location for each of the three groups, with results of 8, 4, and 11. Consulting the column for left-side hits, he finds that the 5-point groups of damage hit the target's center torso and left arm. The remaining 2-point group strikes the target's right leg.

## BATTLEMECH HIT LOCATION TABLE

Die Roll (2D6)	Left Side	Front/Rear	Right Side
2*	L. Torso (critical)	C. Torso (critical)	R. Torso (critical)
3	Left Leg	Right Arm	Right Leg
4	Left Arm	Right Arm	Right Arm
5	Left Arm	Right Leg	Right Arm
6	Left Leg	Right Torso	Right Leg
7	Left Torso	C. Torso	Right Torso
8	C. Torso	Left Torso	C. Torso
9	Right Torso	Left Leg	Left Torso
10	Right Arm	Left Arm	Left Arm
11	Right Leg	Left Arm	Left Leg
12	Head	Head	Head

\* A result of 2 may inflict a critical hit. Apply damage to the armor in that section in the normal manner, but the attacking player also rolls once on the Determining Critical Hits Table, p. 35.

### Determining Hit Location

To determine the exact location of a hit, the attacker rolls 2D6 and consults the appropriate column of the BattleMech Hit Location Table.

**SRMs:** The attacker rolls a separate hit location for each short-range missile (SRM) that hits.

**LRMs and MRMs:** The attacker makes one hit location roll for every 5 long-range missiles (LRM) or medium-range missiles (MRM) that hit the target. Group the missiles that hit into clusters of 5; in other words, form as many 5-point groups as possible, assigning any remaining points to one smaller group, and determine a hit location for each cluster.

**Vehicles:** Vehicle Hit Location Tables appear in *Vehicles*, p. 54.

### Aimed Shots

Players may make aimed shots against BattleMechs that are shut down or whose pilots are unconscious, using any weapons other than missile launchers and LB-X autocannon firing cluster munitions. When firing on an immobile BattleMech (see *Firing at Immobile Targets*, p. 31), the attacking player can make an aimed shot by naming a target location. Against any hit location except the head, the player makes the to-hit roll using the standard -4 to-hit modifier for firing at an immobile target. If the attack is successful, the player rolls again: on a result of 6, 7, or 8, his shot hits the designated location. For any other result, the player rolls normally on the BattleMech Hit Location Table. (This roll may still result in the attack striking the desired location.)

If the attacker is taking an aimed shot at the target BattleMech's head, modify the to-hit number by +3 rather than the normal -4. If the shot hits, the player rolls 2D6. On a result of 6, 7, or 8, the shot hits the head. For any other result, roll normally on the BattleMech Hit Location Table.

### DAMAGE

Each attack that successfully hits the target does damage to the target. Every weapon does a specific amount of damage, which appears on the appropriate Weapons and Equipment Table, beginning on p. 115.

Each missile type does the same amount of damage at any range, but the number of missiles that hit determines how much damage a missile attack inflicts. Long-range and medium-range missiles have a Damage Value of 1, and short-range missiles have a Damage Value of 2 for each missile that hits its target.

### RECORDING DAMAGE

Follow the step-by-step procedure outlined in *Damage Resolution* (p. 34) to determine the effects of damage.

**Vehicles:** Hits against vehicles follow the same general procedure as hits against BattleMechs, though they cannot survive the destruction of a location and damage does not transfer. See *Vehicles*, p. 54.

*Infantry and Buildings:* Hits against infantry and buildings are recorded differently from hits on BattleMechs and vehicles. See *Infantry*, p. 60, and *Buildings*, p. 52, for details.

## Torso Destruction

If a BattleMech's right or left torso has all of its internal structure destroyed, the corresponding arm is blown off immediately and can sustain no further damage (see *BattleMech Critical Hit Effects*, p. 36). The corresponding leg is not damaged. If the center torso is destroyed, the entire unit is destroyed (see *Destroying a Unit*, p. 38).

## Leg Destruction

When a BattleMech loses one leg, either through a critical hit or the destruction of the leg's internal structure, the BattleMech automatically falls. In subsequent turns, the BattleMech may attempt to stand on its remaining leg, but the pilot must add a +5 modifier to the Piloting Skill Roll plus any modifiers for other damage. If the BattleMech manages to stand, it has a Walking MP of 1 and cannot run. To take into account the missing leg, add +5 to any Piloting Skill Roll made thereafter. The BattleMech may still jump (minus the power of the jump jets on the missing leg), but the pilot must make a Piloting Skill Roll each time the 'Mech lands.

## DAMAGE RESOLUTION

To apply damage from an attack, begin with the amount of damage the attack inflicts and the hit location of the attack, and start at Step 1. Answer each question with yes or no, and follow the instructions.

### 1. Is there armor in the location?

**Yes:** Check off one armor box on the Armor Diagram in the appropriate location for every point of damage taken, until all damage is applied or all armor in the location is destroyed. Go to Step 2.

**No:** Proceed to Step 3.

### 2. Is there damage remaining?

**Yes:** Go to Step 3 to allocate remaining damage.

**No:** Attack is finished.

### 3. Is there internal structure in the location?

**Yes:** Check off one internal structure box on the Internal Structure Diagram in the appropriate location for every point of damage taken, until all damage is applied or all internal structure in location is destroyed. Go to Step 4.

**No:** Proceed to Step 6.

### 4. At the beginning of the current phase, were there any components in the location that could sustain a critical hit?

**Yes:** Roll once on the Determining Critical Hits Table. Apply the effects of any critical hits to the location. Excess critical hits that cannot be applied are not transferred. Go to Step 5.

**No:** Roll once on the Determining Critical Hits Table. Any critical hits are applied to the next location inward (see Damage Transfer Diagram). Go to Step 5.

### 5. Is there internal structure remaining in the location?

**Yes:** Attack is finished.

**No:** The location and all components contained in it are destroyed. The destruction of components in this fashion will not cause ammunition (or other component) explosions, but otherwise all components in the location are affected as though they were critically hit. Go to Step 6.

### 6. Is there damage remaining?

**Yes:** Go to Step 7 to allocate remaining damage.

**No:** Attack is finished.

### 7. Was the damage resulting from an ammunition (or other internal component) explosion?

**Yes:** Go to Step 8.

**No:** Damage transfers to the armor of the next location inward (see Damage Transfer Diagram). Go to Step 1.

### 8. Is the location protected by CASE?

**Yes:** The remaining damage is lost. The attack is then finished.

**No:** The remaining damage transfers to the next location inward (see Damage Transfer Diagram), directly to the internal structure. Go to Step 3.

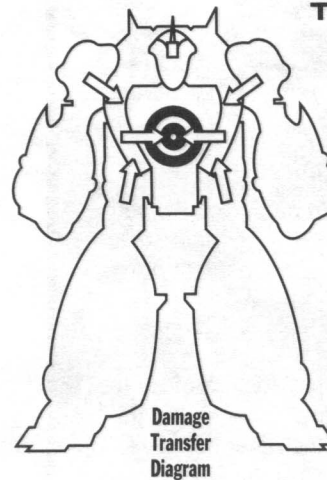

## TRANSFERRING DAMAGE

BattleMechs can survive the destruction of any body section except the head or center torso. If a section is destroyed and the same location takes another hit, or excess damage remains from the shot that destroyed the location, that damage transfers to (affects) the outer armor of the next location inward. Excess ammunition explosion damage is transferred directly to the internal structure of the next location inward. This principle

is illustrated on the Damage Transfer Diagram at left.

Damage to a missing arm or leg transfers to the torso on the same side (left leg or arm damage is transferred to the left torso, right arm or leg damage is transferred to the right torso). Additional damage to a destroyed side torso location transfers to the center torso. Damage from a destroyed head or center torso does not transfer.

Damage from the rear firing arc that hits a missing limb is transferred to the appropriate rear torso location. For example, damage from the rear that hits a missing left leg would be transferred into the left rear torso.

*A Grasshopper's left arm is hit by an attack from a PPC (Damage Value 10), a large laser (Damage Value 8), and two 5-point groups of long-range missiles (Damage Value of 1 per missile hit or 5 points per*

group). Before this turn, the BattleMech still had its full Armor Value of 22 in that arm.

The PPC hit reduces the Armor Value by 10, so 10 boxes are filled in. The laser hit does 8 points of damage, and so 8 more boxes are filled in, leaving 4 boxes. The first cluster of missiles reduces the Armor Value by another 5 points, but since the Grasshopper's remaining Armor Value is 4, that leaves 1 point of damage that the hit location cannot absorb.

The remaining 1 point of damage from the first cluster of missiles transfers to the 'Mech's internal structure, and so 1 box is filled in on the Internal Structure Diagram, leaving only 10 boxes out of the original 11. The last group of missiles reduces the internal structure by another 5 points. Five more boxes are filled in on the Internal Structure Diagram, leaving 5. If the Grasshopper's left arm takes a hit from a weapon that inflicts 5 or more points of damage, it will be completely destroyed.

## CRITICAL DAMAGE

Every time the internal structure of a BattleMech or vehicle takes damage, either from a weapon attack, a physical attack or an ammo explosion, an internal component may take critical damage.

To determine whether a unit takes critical damage from an attack that damages the internal structure, the attacking player rolls 2D6 and consults the Determining Critical Hits Table. On a result of 8 or higher, the target unit takes critical damage. The higher the result, the more serious the damage. If the unit takes critical damage, the target player rolls 2D6 and consults the unit's Critical Hit Table to determine the precise location of the damage, as described in *BattleMech Critical Hits*, p. 35.

Each successful attack that damages internal structure creates only one opportunity for the attacker to inflict a critical hit, regardless of the number of internal structure boxes that a single weapon (or other attack) destroyed (see *Hit Location Critical Hits* for an exception). The attacking player rolls 2D6 only once for each potential critical hit.

The location of the damage determines the exact nature of the critical hit. Each part of a BattleMech's body can be affected by several types of critical hits. Further, every type of BattleMech can suffer different critical hits, depending on the array of weapons and other equipment it carries. The Critical Hit Table for each type of BattleMech appears on the record sheet for that type. A partially blank Critical Hit Table that can be customized for all BattleMechs is provided on all blank BattleMech Record Sheets.

**Vehicles:** Unlike BattleMechs, which have a unique Critical Hit Table for every design, all vehicles use a standard set of Critical Hit Tables. The Critical Hit Tables for the various types of vehicles appear in *Vehicles*, p. 54.

**Hit Location Critical Hits:** Certain results on the hit location tables provide the chance for a critical hit, even if the internal structure was not damaged by the attack. These are resolved by rolling on the Determining Critical Hits Table just as

for other checks for critical hits. This chance is in addition to the normal roll for a critical hit provided by damaging the internal structure. For example, a hit location result of 2 against a BattleMech with no torso armor left would provide two rolls on the Determining Critical Hits Table. If the 'Mech had armor in the location hit, there would still be one chance for a critical hit.

## DETERMINING CRITICAL HITS TABLE

Die Roll (2D6)	Effect
2-7	No Critical Hit
8-9	Roll 1 Critical Hit Location
10-11	Roll 2 Critical Hit Locations
12	Head/Limb Blown Off/Roll 3 Critical Hit Locations*

\* Roll 3 critical hit locations if the attack strikes the torso.

## BATTLEMECH CRITICAL HITS

When an attacker inflicts a critical hit on a target, the target player finds the damaged location on the Critical Hit Table on his BattleMech's record sheet, then rolls dice for each critical hit and marks off the damage inflicted on the Critical Hit Table.

**Head or Leg Hits:** If the critical hit is inflicted on the BattleMech's head or legs, roll 1D6, find the result on the Critical Hit Table, and mark off the damaged location. If the critical location rolled cannot take a critical hit or has already been destroyed by a critical hit, roll the die again.

**Torso or Arm Hits:** If the critical hit strikes the torso or arms of the BattleMech, the player rolls both dice. The result of the first die tells which half of the Critical Hit Table for that location is affected, and the result of the second die identifies the location hit. The Critical Hit Table for these locations is divided into two sets of 6 critical slots, labeled 1-3 and 4-6.

The result of the first die identifies which set of slots takes the hit. On a result of 1, 2, or 3, the shot hits a location in the first set of critical slots. On a result of 4, 5, or 6, the attack hits a location in the second set of critical slots. The result of the second die roll identifies the critical slot that takes the hit.

*A Grasshopper takes a critical hit to the left arm. The defending player rolls the first die with a result of 3. This means the critical hit will affect a slot in the first half of the Critical Hit Table for the left arm (labeled 1-3). The player rolls the second die with a result of 2, inflicting a critical hit on the 'Mech's upper arm actuator.*

Each weapon and other piece of equipment fills at least one slot on the Critical Hit Table. If the player rolls damage for a slot for which there is no component; a slot that cannot take critical damage such as endo steel, CASE, or ferro-fibrous; or a slot that has already taken a critical hit, he rolls both dice again.

Note that some weapons, double heat sinks and other equipment take up multiple slots on the Critical Hit Table. A single critical hit disables any weapon or equipment except the engine, gyro, and sensors. (However, a heat sink critical hit destroys only the specific heat sink hit.) Critical hits on additional slots occupied by the weapon, double heat sink, and so on only increase the difficulty of repairing the damaged equipment (see *Repairs and Replacements*, p. 85).

### Transferring Criticals:

If all of the possible slots in the damaged area took critical hits in previous phases, or if there were no items that could be affected by critical hits in the location in the first place, the critical hit transfers to the next location per the Damage Transfer Diagram. Critical hits to the center torso and head do not transfer.

## BATTLEMECH CRITICAL HIT EFFECTS

Each type of critical hit affects a 'Mech's performance in a specific way, as described below. The critical hit locations are arranged alphabetically by item; the location of the item on the 'Mech (head, leg, torso, arm) is noted in parentheses.

### Ammunition

If a critical hit destroys a slot carrying ammunition, the ammo there explodes. The MechWarrior automatically takes 2 Damage Points as a result of the feedback received through his neurohelmet. In addition, the BattleMech takes damage to its internal structure.

Calculate the total Damage Value of all ammo carried in the slot and apply that total to the Internal Structure Diagram (ammunition explosion damage starts the *Damage Resolution* process at Step 3, as described on page 34). If the location is not protected by CASE, any excess damage transfers to the internal structure of the next location. For locations protected by CASE, vent any remaining damage without further harm. See *Equipment*, p. 126, for details.

A critical hit to an ammo slot only explodes the ammo in that slot. It explodes with a force equal to the ammo's Damage

Value times the shots remaining. Missile ammo explodes with a force equal to the number of missiles remaining times their Damage Value. For example, 1 full ton of machine gun ammo explodes with a force of 400 points of damage (2 x 200), while 1 full ton of SRM-2 ammo explodes with a force of 200 points of damage (2 x 2 x 50).



### Arm Blown Off (Arm)

This critical hit occurs when the player rolls a result of 12 on the Determining Critical Hits Table, when the location hit is an arm. It blows off the arm, and the weapons mounted in that arm are no longer available to the 'Mech. The arm may be picked up and used as a club per the rules for *Club Attacks*, p. 40.

**Salvage:** If the blown-off arm is recovered, the equipment mounted in it, including armor and internal structure, is in the same condition it was in at the time the limb was blown off.

### Cockpit (Head)

A critical hit to the cockpit destroys that slot, kills the MechWarrior, and puts the BattleMech out of commission for the game.

### Engine (Torso)

BattleMech engines have 3 points of shielding. Each critical hit to an engine slot destroys 1 point of shielding.

As points of shielding are destroyed, the amount of heat escaping from the BattleMech's fusion drive increases.

The first hit increases the 'Mech's heat buildup by 5 points per turn. The second hit results in 10 (total) points of added heat buildup per turn, and the third critical hit to an engine slot shuts down the engine and puts the BattleMech out of commission for the rest of the game. Though XL engines (see p. 134) take up additional slots (in the side torsos), critical hits to any 3 engine slots also shut down an XL engine. Note this means an Inner Sphere 'Mech with an XL engine is destroyed if its center torso or either of its side torso locations are destroyed.

### Foot Actuator (Leg)

This critical hit destroys the muscle (actuator) in the foot. For each foot actuator damaged, reduce the BattleMech's Walking MP by 1 and add a +1 modifier to any subsequent

Piloting Skill Roll. A Piloting Skill Roll is required whenever the BattleMech jumps. Kick attacks made with the affected leg have a +1 to-hit modifier.

These effects are cumulative with other leg and foot actuator damage.

## Gyro (Torso)

The gyroscope is a BattleMech's most sensitive piece of machinery. It keeps the BattleMech upright and able to move. The gyro can survive only 1 critical hit; the second destroys it.

After the first critical hit to the gyro, the player must make a Piloting Skill Roll every time the damaged BattleMech runs or jumps, with a modifier of +3. Make this roll at the end of each such move.

When a BattleMech's gyro is destroyed (after a second critical hit), the 'Mech automatically falls and cannot stand up again. BattleMechs with a destroyed gyro may make weapons attacks per *Firing When Down*, p. 31, and may change their facing by one hexside per turn provided they have at least 1 MP available.

## Hand Actuator (Arm)

A critical hit to the hand actuator destroys the muscles controlling the BattleMech's wrist and hand. Add a +1 to-hit modifier to all punches made with this arm. In addition, the 'Mech can no longer make clubbing attacks and hatchet/sword attacks with this arm. This effect is cumulative with the effects of destroyed arm actuators.

## Head Blown Off (Head)

A hit blows off a BattleMech's head when the player rolls a result of 12 on the Determining Critical Hits Table when the location hit is the head. This critical hit destroys the BattleMech's head location, kills the MechWarrior and puts the BattleMech out of commission for the rest of the game.

**Salvage:** Unlike other Limb Blown Off results, this critical hit destroys all slots in the head, leaving nothing for salvage.

## Heat Sink

One critical hit to a heat sink destroys the heat sink and reduces the BattleMech's ability to dissipate heat. For example, if a BattleMech is designed to dissipate 16 points of heat per turn and 3 of its heat sinks have been destroyed, it can now only dissipate 13 points of heat per turn.

A double heat sink takes up more than one slot on the Critical Hit Table but is destroyed by a single critical hit. Additional critical hits to a multi-slot heat sink produce no further effects. Each double heat sink destroyed reduces the 'Mech's ability to eliminate heat by 2 points.

## Hip (Leg)

A hip critical hit freezes the affected leg in a straight position. The BattleMech's Walking MP is cut in half (round up). Add a +2 modifier to any Piloting Skill Rolls required, and make a Piloting Skill Roll every turn that the damaged BattleMech runs or jumps. The 'Mech cannot make kick attacks.

After a hip critical hit, ignore all modifiers from previous critical hits on that leg. Note that this means it is possible for a 'Mech's performance to actually improve after a hip critical hit if it had suffered previous critical damage to the same leg. Since the leg becomes locked in a straight position, it serves as a sort of crutch, making movement easier in some cases than moving on a number of free-flexing damaged actuators.

A critical hit to the second hip reduces the BattleMech's Movement Points to 0 and adds another +2 modifier to its Piloting Skill Roll target number.

## Jump Jet (Leg/Torso)

When a jump jet exhaust port takes a critical hit, that jump jet can no longer deliver thrust. This decreases the distance the BattleMech can jump. For each exhaust port hit, reduce the BattleMech's Jumping MP by 1.

## Leg Blown Off (Leg)

This critical hit occurs when the player rolls a result of 12 on the Determining Critical Hits Table when the location hit is a leg. When a BattleMech's leg is blown off, the 'Mech automatically falls and takes normal falling damage, though it might be able to stand up again. See *Leg Destruction*, p. 34. The leg may be picked up and used as a club per the rules for *Club Attacks*, p. 40.

**Salvage:** If the blown-off leg is recovered, the equipment mounted in it, including armor and internal structure, is in the same condition it was in at the time the limb was blown off.

## Life Support (Head)

A BattleMech's life-support system protects its pilot from the machine's internal heat and keeps him alive on airless worlds and in hostile environments. In *BattleTech*, the life-support system's main function is to protect the pilot from the heat generated by the 'Mech's fusion reactor, movement and weapons systems.

Any critical hit knocks this system out permanently and leaves the pilot vulnerable to increased heat. The MechWarrior takes 1 point of damage every Heat Phase that the BattleMech's internal heat ranges from 15–25, and 2 points of damage for every turn that its internal heat is above 25 on the Heat Scale.

A life-support critical hit also eliminates the 'Mech's internal air supply. If the 'Mech is submerged (in Depth 2 or deeper water or prone in Depth 1 or deeper water) or is in a vacuum (see *Hostile Environments*, p. 78) in the End Phase of any turn, the pilot will take 1 point of damage.

## Lower Arm Actuator (Arm)

This critical hit destroys the actuator in the BattleMech's lower arm. Add a +1 modifier to the to-hit number for weapons firing from that arm and a +2 modifier for all clubbing attacks and any punches or hatchet/sword attacks with this arm. Damage from punches with this arm is halved (round down).

These effects are cumulative with other arm and hand actuator damage.

**Missing Actuators:** Some BattleMechs are designed without one or both lower arm actuators. These 'Mechs do not suffer the weapon attack modifier for the missing actuators, though the modifiers for physical attacks still apply.

## Lower Leg Actuator (Leg)

This critical hit destroys the muscle (actuator) in the lower leg. For each leg actuator damaged, reduce the BattleMech's Walking MP by 1 and add a +1 modifier to any subsequent Piloting Skill Roll. The player must make a Piloting Skill Roll whenever the BattleMech jumps. Kick attacks made with the affected leg have a +2 to-hit modifier and inflict half damage (round down).

These effects are cumulative with other leg and foot actuator damage.

## Sensors (Head)

When a BattleMech takes a critical hit to the sensors, add a +2 modifier to the to-hit number every time the 'Mech fires its weapons. A second sensor hit makes it impossible for the BattleMech to fire any of its weapons. Critical hits to sensors do not affect physical attacks.

## Shoulder (Arm)

A critical hit to this location freezes the shoulder joint. The 'Mech may not punch or make hatchet/sword attacks with that arm. It may not make clubbing attacks, and adds a +2 modifier to pushing attack to-hit numbers for each damaged shoulder. Add a +4 modifier to the to-hit number for all weapon attacks made with weapons mounted on that arm. After a shoulder critical hit, ignore all other weapons fire modifiers from critical hits to that arm.

## Upper Arm Actuator (Arm)

This critical hit destroys the actuator in the BattleMech's upper arm. Add a +1 modifier to the to-hit number for weapons firing from that arm and a +2 modifier for all clubbing attacks as well as any punches or hatchet/sword attacks with this arm. Damage from punches with this arm is halved (round down).

These effects are cumulative with other arm and hand actuator damage.

## Upper Leg Actuator (Leg)

This critical hit destroys the muscle (actuator) in the upper leg. For each leg actuator damaged, reduce the BattleMech's Walking MP by 1 and add a +1 modifier to any subsequent Piloting Skill Roll. The player must make a Piloting Skill Roll whenever the BattleMech jumps. Kick attacks made with the affected leg have a +2 to-hit modifier and inflict half damage (round down).

These effects are cumulative with other leg and foot actuator damage.

## Weapons and Equipment

Weapon systems are surprisingly delicate, and so a single critical hit disables a weapon or other internal component. Though some weapon systems occupy more than one slot on the Critical Hit Table, the first critical hit knocks out the weapon. Additional critical hits to a multislot weapon have no further effect, other than to make the equipment more difficult to repair. For example, a particle projector cannon fills 3 critical slots. However, the PPC is disabled as soon as one of its three critical slots takes a hit.

**Explosive Components:** Certain non-ammo components such as Gauss rifles can explode when they suffer critical hits. The specific rules for the equipment will state if this is the case, and how much damage is inflicted (see *Equipment*, p. 122). These explosions are handled in exactly the same way as ammunition explosions.

## DESTROYING A UNIT

Under the specific conditions described below, a unit must be considered destroyed. Note that a "destroyed" unit may not be actually physically destroyed. It simply is rendered tactically useless and is referred to as a "mission kill." Such units are out of the game, but they may be repaired later if the rules for *Scavenging and Repair*, p. 82, are being used. Destroyed units are removed from the map in the end of the phase in which they were destroyed, and have no further effect on game play.

## BATTLEMECHS

A BattleMech is considered destroyed and out of the game if its MechWarrior dies or the BattleMech suffers 3 engine hits. Note that the destruction of the head, cockpit, or center torso has the same effects and renders a BattleMech destroyed. In addition, an Inner Sphere 'Mech with an XL engine is destroyed if the internal structure of the right or left torso is destroyed.

**MechWarrior Survival:** The MechWarrior dies when the 'Mech's head, cockpit or center torso is destroyed by an ammunition explosion or area saturation artillery attack, unless he is able to eject (see *Ejecting*, p. 73).

## VEHICLES

A vehicle is considered destroyed and out of the game when all of its internal structure boxes in one section are marked off, or when its Critical Hit Table indicates that it is destroyed.

**Crew Survival:** With no ejection system to save them, a vehicle's crew is killed when the vehicle is destroyed.

## INFANTRY

Unarmored infantry platoons are considered destroyed when all boxes in the unit row have been marked off. Battle-armored units are destroyed when all boxes in each unit member's row have been marked off.

**Trooper Survival:** Each trooper checked off as damage is not necessarily killed, but is wounded enough to be out of action.

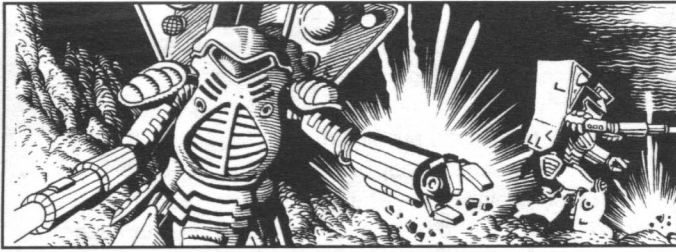

## PHYSICAL ATTACKS

BattleMechs can make six different types of physical attacks: punching, clubbing, pushing, kicking, charging and death from above. In order to make a physical attack, the unit must be adjacent to its target and the target must be within the attacking 'Mech's forward firing arc (see *Punch Attacks*, *Charge Attacks*, and *Death from Above Attacks* for exceptions).

Each type of physical attack has a unique base to-hit number (not based on Gunnery or Piloting Skill), but is otherwise resolved in the same way as a weapon attack unless specifically stated otherwise in the rules for each type of attack. To-hit modifiers for physical attacks are shown on the Attack Modifiers Table on page 32.

The rules for physical attacks assume both the attacker and target are BattleMechs standing at the same elevation level. Special rules regarding other types of units, different elevations, and prone 'Mechs appear at the end of this section.

A BattleMech may make only one form of physical attack per turn. For example, BattleMechs may not punch and kick in the same turn.

**Vehicles:** The only kind of physical attack a vehicle can make is a charge (ram).

**Infantry:** Infantry units cannot make physical attacks.

### PHYSICAL ATTACK BASE TO-HIT NUMBERS

Attack Type	Base To-Hit
Accidental Fall from Above	7
Charging	5
Clubbing	4
Death from Above	5
Kicking	3
Punching	4
Pushing	4

## PUNCH ATTACKS

In a single turn, a BattleMech may punch with one or both arms. It can either deliver a punch using its arm or fire the weapons on that arm, but it may not do both. Weapons mounted in the torso, legs, or head may be fired in the same turn as a punch attack is made without affecting the punch.

All punch attacks must be made against targets in the attacking BattleMech's forward or side firing arcs. If the target is

in the right or left arc, then only the right or left arm, respectively, may punch. If the target is in the forward arc, then both arms may be used in the punch attack.

A BattleMech cannot make a punch attack using a shoulder suffering from critical damage, and any arm actuator damage on the punching arm makes success more difficult and will reduce the damage inflicted.

The Base To-Hit Number for a punch is 4, plus modifiers (p. 29). The player makes separate to-hit rolls and inflicts separate damage for each arm making a punching attack.

The punch from each arm has a Damage Value of 1 for every 10 tons (or fraction of 10 tons) that the attacker weighs. Reduce the damage by half for each arm actuator (upper or lower arm, not hand) damaged or not present, with these effects being cumulative. In other words, if both arm actuators are missing, reduce the damage to one-quarter of its original value (round fractions down).

Determine the hit location by rolling 1D6 and consulting the BattleMech Punch Location Table.

### BATTLEMECH PUNCH LOCATION TABLE

D6 Roll Result	Left Side	Front/Rear	Right Side
1	Left Torso	Left Arm	Right Torso
2	Left Torso	Left Torso	Right Torso
3	Center Torso	Center Torso	Center Torso
4	Left Arm	Right Torso	Right Arm
5	Left Arm	Right Arm	Right Arm
6	Head	Head	Head

**Missing Actuators:** A BattleMech does not need hands (or hand actuators) to punch. Note, however, that BattleMechs not equipped with a hand on the punching arm must add the +1 modifier as for a hand actuator critical hit. Likewise, BattleMechs that do not come equipped with a lower arm actuator on the punching arm must add a +2 modifier to the to-hit number and they inflict only half damage (round down) with the punch.

*A Grasshopper with a damaged upper arm actuator punches a JagerMech on the right side with one fist. Because the Grasshopper has a damaged arm actuator, the player adds a to-hit modifier of +2 and reduces the normal damage by half (rounding down). Neither unit moved and there is no terrain that affects the attack, so the Modified To-Hit Number is a 6 (4 + 2); the player rolls an 8 and hits the target. The Grasshopper weighs 70 tons, so its punch has a normal Damage Value of 7 (70 divided by 10), but this is reduced to 3 because of the damaged actuator. The attacking player rolls a 3 on the BattleMech Punch Location Table, which means the attack hits the target's center torso.*

## CLUB ATTACKS

To attack another unit with a club, all the BattleMech's shoulders and hand actuators must be undamaged, and no arm-mounted weapons can have been fired in that same turn, though weapons mounted in the torso, legs and head may be fired. The target must be in the forward firing arc.

The unit making the attack with a club makes a two-handed swing using a Base To-Hit Number of 4, plus modifiers (p. 29). A successful attack with a club does 1 point of damage for every 5 tons that the attacking BattleMech weighs. Roll normally on the BattleMech Hit Location Table.

**Missing Actuators:** A BattleMech must have hands (or hand actuators) to use a club. Likewise, BattleMechs that do not come equipped with lower arm actuators or whose lower or upper arm actuators are damaged must add a +2 modifier to the to-hit number for each missing/damaged actuator.

## FINDING A CLUB

Whenever an attack blows off one of a BattleMech's legs or arms, the limb remains lying in the hex where the BattleMech took the damage. BattleMechs that later occupy that hex may pick up the arm or leg and use it as a giant club. A BattleMech may not fire weapons or make physical attacks during the turn that it picks up a club.

Other objects may also be used as clubs. If the BattleMech is in a wooded hex, it may uproot a tree and use it as a club. Uprooted trees may be used for only 1 successful club attack. Girders from rubble Medium, Heavy, or Hardened Buildings may also be used as clubs. To search the rubble in the hex it occupies for a suitable girder, the player must roll 2D6 during the Weapon Attack Phase of a turn. A result of 7+ is needed to find a girder in a rubble Medium Building, a 6+ is needed for a rubble Heavy Building, and a 5+ is needed for a rubble Hardened Building.

## HATCHETS AND SWORDS

Some BattleMechs come equipped with hatchets. Like other weapons, hatchets have weight and take up one or more slots on the Arm section of the Critical Hit Table. To use the hatchet, a BattleMech must have a functioning hand actuator and shoulder in the arm in which the hatchet is mounted.

A BattleMech uses a hatchet to make physical attacks per the standard club attack rules, but need use only one arm for the attack, rather than two. This means the target can be in the front firing arc or in the side arc corresponding to the arm in which the hatchet is mounted. Though a BattleMech may mount two hatchets, one in each arm, the pilot can make only one hatchet attack per turn. The pilot may fire weapons mounted in the arm not carrying the attacking hatchet in the Weapon Attack Phase.

Hits on a hatchet critical slot represent damage to the shaft of the weapon. If a hatchet critical slot takes a hit, the weapon is no longer functional.

**Swords:** BattleMech swords are used in the same way as hatchets, but they have slightly different characteristics, as shown on page 133.

## PUSH ATTACKS

A BattleMech uses both arms to make a pushing attack against its target, which must be another BattleMech. A BattleMech may make no arm-mounted weapon attacks in the turn that it makes a pushing attack. All torso-, leg-, and head-mounted weapons may be fired normally. Pushing attacks can be made against a target in the hex directly in front of the attacker (based on the orientation of its feet, not its upper body, as in the case of a torso twist).

The Base To-Hit Number for a push is 4, plus modifiers (p. 29). A successful push attack does not damage the target. Instead, it moves the defending BattleMech into the adjacent hex in the direction that it is being pushed by the attacker. If the push is successful, the attacking BattleMech advances into the hex formerly occupied by its target. At the same time, the defender must make a successful Piloting Skill Roll or fall. See also *Unit Displacement*, p. 44.

**Multiple Pushes:** Only one push attack may be declared against a single target per turn. If two 'Mechs are pushing each other, resolve both attempts and apply the net effect. If both attacks fail, nothing happens. If both attacks succeed, neither 'Mech moves, and both must make Piloting Skill Rolls or fall. If only one of the push attacks succeeds, resolve it as usual.

**Shoulder Actuators:** Each damaged shoulder actuator adds +2 to the pushing 'Mech's target number.

*If the 'Mech in Hex A is successfully pushed by the BattleMech in Hex B, it moves into Hex C. If the 'Mech in Hex A is successfully pushed by a BattleMech in Hex D, it will be forced into Hex E. In both cases, the pilot of the target 'Mech must make a Piloting Skill Roll to remain standing, and its attacker will advance into Hex A. Note that the 'Mech in Hex A cannot push either of its opponents because neither of them lies directly in front of it.*

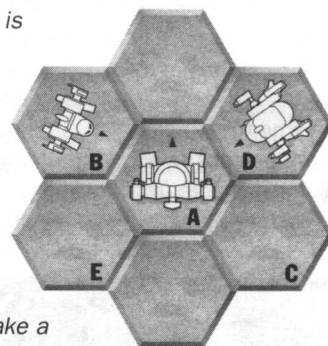

## KICK ATTACKS

A BattleMech may only make a kicking attack with one leg per turn. No weapons mounted on that leg can fire in the turn in which the 'Mech kicks. To make a kicking attack, both hips must be undamaged, and the BattleMech's target must be in one of the 3 forward-arc hexes, based on the facing of the feet (not the upper body, as in the case of a torso twist).

A player who declares that his BattleMech will make a kicking attack uses a Base To-Hit Number of 3, plus modifiers (p. 29). Kicks have a Damage Value of 1 point for every 5 tons of the attacking BattleMech's weight. For example, a 70-ton *Grasshopper's* kick would inflict 14 Damage Points.

Determine the location of the damage by rolling 1D6 and consulting the BattleMech Kick Location Table.

## BATTLEMECH KICK LOCATION TABLE

Die Roll Result	Left Side	Front/Rear	Right Side
1-3	Left Leg	Right Leg	Right Leg
4-6	Left Leg	Left Leg	Right Leg

A BattleMech that has been successfully kicked must make a Piloting Skill Roll. If the attacking BattleMech misses its kick, it must make a Piloting Skill Roll.

**Critical Damage:** Reduce this damage by half for each upper and lower leg actuator damaged on the kicking leg, with these effects being cumulative. For example, if two leg actuators are missing, reduce the damage to one-quarter its original value, rounding fractions down.

**Vehicles:** A BattleMech can kick a vehicle in its forward arc or kick (stomp) a vehicle in the hex it occupies. The side on which a vehicle takes damage is determined randomly if the BattleMech is attacking from the same hex.

**Infantry:** A BattleMech may kick (stomp) an infantry unit in the hex it occupies, but apply a +3 to-hit modifier for such an attack—infantry troopers tend to scurry out of the way when BattleMechs get too close, making them harder to hit.

## CHARGE ATTACKS

In order for a unit to charge, it may not have moved backward in the Movement Phase of the turn. The target must be in the hex directly in front of the charging unit (disregarding torso twists) at the beginning of the Physical Attack Phase. The charging unit may not make any weapon attacks in the same turn.

Charging attacks must be declared during the Movement Phase, but like all other physical attacks, they are resolved during the Physical Attack Phase. This means that the charging unit can only attack units that have finished their movement. It also means a unit that is charging cannot be the target of a charge or death from above attack, because its movement will not be finished until the end of the Physical Attack Phase.

The charging unit must spend Movement Points to enter the target hex, whether or not the charge is successful. If a unit does not have enough Movement Points left over from its Movement Phase to enter the target hex, it may not make a charging attack. In addition, if the target occupies terrain that the attacking unit is restricted from entering, the unit may not charge.

The Base To-Hit Number for a charge is 5, and along with the usual modifiers, there is a special modifier applied to charge attacks. Whenever one unit charges another, compare their Piloting Skills and use the difference between the two skill levels as a modifier to the to-hit number. If the target's skill level is lower, add the modifier to the to-hit number. If the attacker's Piloting Skill level is lower, subtract the modifier from the to-hit number.

**Multiple Attacks:** A unit may only be the target of one charging or death from above attack in a given turn.

**Vehicles:** All vehicles, with the exception of VTOLs, may make charging attacks. Vehicles may charge other vehicles but may not be charged by BattleMechs.

**Infantry:** Infantry units may not be the target of charging attacks.

**Unusual Targets:** A vehicle or BattleMech unit may charge a building and may be forced to accidentally charge a building or hill under certain circumstances.

*A Black Hawk with a Piloting Skill level of 4 is charging a Grasshopper with a Piloting Skill level of 5. Because the attacking MechWarrior's skill level is lower, the difference between the two is subtracted from the to-hit number, providing a -1 to-hit modifier. If the skill levels of the pilots were reversed, the attack would suffer a +1 to-hit modifier.*

## DAMAGE

If the attack succeeds, both units take damage from the collision. The defender takes 1 point of damage for every 10 tons that the charging unit weighs, multiplied by the number of hexes moved by the attacker in the Movement Phase (note that this is hexes moved, not counting the hex containing the target, and not MP expended). The charging unit takes 1 point of damage for every 10 tons the target weighs (round fractions up).

Group the damage resulting from charging attacks into 5-point clusters. The attacking player rolls once on the appropriate Hit Location Table for each cluster, in the same manner as for LRM damage.

If a unit charges a target that is in a building, the building absorbs damage as normal (see *Combat Effects in Buildings*, p. 51). The charging pilot also must make a Piloting Skill Roll modified by +3 in addition to the building modifier to avoid taking damage from entering the building (see *Movement Effects in Buildings*, p. 50). If the target unit must pass through walls as a result of a successful charge (the unit is pushed out of its position), the target pilot must make a Piloting Skill Roll modified by +3 to avoid taking damage.

**Vehicles:** When a vehicle charges a standing BattleMech, allocate damage according to the BattleMech Kick Location Table. Against another vehicle or a prone 'Mech, the normal hit location rules apply.

**Unusual Targets:** If a charge attack is made against a target with no tonnage, such as a building or hill (for example, as the result of a skid), the damage to the attacker is calculated using the attacker's tonnage rather than the target's.

*A 65-ton JagerMech moves 5 hexes and declares a charging attack against another BattleMech. If the charging attack is successful, the target takes 33 points of damage (6.5 for the JagerMech's tonnage multiplied by 5 for the number of hexes it moved, rounded up).*



## LOCATION AFTER ATTACK

If the charging attack succeeds, the defending unit is forced to move just as if it had been pushed, and the attacker advances into the defender's hex. (See *Unit Displacement*, p. 44). If the attacker misses the target, the attacking player places the attacking unit in the hex to the right or left of its forward arc.

## FALLS

After any successful charging attack, both the attacking and defending BattleMechs must make Piloting Skill Rolls modified by +2, plus all other applicable modifiers, or fall in the hex they currently occupy.

## DEATH FROM ABOVE ATTACKS

A desperate MechWarrior piloting a jump-capable 'Mech can literally leap onto his target, with the aim of bringing the full weight of his machine crashing down on the victim's head. This type of attack, known among MechWarriors as "death from above," is extremely difficult and always results in some damage to the attacker ('Mech legs were not designed to take this kind of stress), so it is rarely attempted except as a last-ditch measure.

The death from above attack (DFA) may actually cause less damage than a standard charging attack, but the damage is concentrated on the upper part of the target BattleMech, with a good chance of hitting the head. Though not particularly

effective, this kind of attack can also be made against vehicle and infantry targets.

In order to execute a DFA, the attacker must have enough MP and be able to jump into the hex containing the target. The attacker then literally jumps into the hex containing the target, though it stops just short of that hex until the Physical Attack Phase (see *Weapon Attack Phase*, p. 43).

DFA attacks must be declared during the Movement Phase, but like all other physical attacks, they are resolved during the Physical Attack Phase. This means that the attacking unit can only attack units that have finished their movement. It also means a unit that is making a DFA cannot be the target of a charge or DFA, since its movement will not be finished until the end of the Physical Attack Phase.

A BattleMech making a DFA cannot be the target of physical attacks, but may be the target of weapon attacks.

**Multiple Attacks:** A unit may only be the target of one charging or DFA attack in a given turn.

**Stacking:** A BattleMech does not count as stacked in a hex while executing a death from above attack until it completes its attack. As soon as it lands, normal stacking limits apply (see *Stacking*, p. 20).

## WEAPON ATTACK PHASE

The attacking unit cannot make any weapon attacks during a turn in which it is executing a DFA.

During the Weapon Attack Phase, the attacking unit is considered to be adjacent to the target hex along the path that the attacking unit will travel during the jump, and facing the target hex. If the path of the jump passes exactly between two hexes adjacent to the target, the attacker must choose which one he will occupy. For the purpose of determining LOS, the attacking unit is considered to be in the air above the hex, standing on an elevation 1 level higher than the target hex or the elevation of the hex the attacker is in, whichever is higher.

**Falls:** If the attacking BattleMech takes damage during the Weapon Attack Phase that forces the pilot to make a Piloting Skill Roll, the player should roll as normal. A failed roll means that the attack automatically misses. Resolve the attacker's fall and ending location per the rules below.

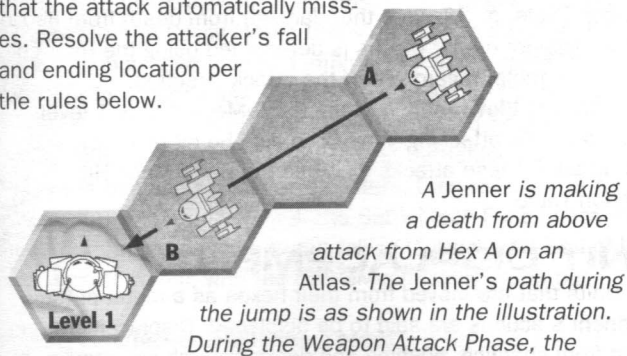

## BASE TO-HIT NUMBER

The Base To-Hit Number for a death from above attack is 5, with all the normal attack modifiers including the jumping movement of the attacker, but not modified for terrain. In addition, whenever one unit makes a death from above attack on another, compare their Piloting Skills and use the difference between the two skill levels as a modifier to the to-hit number in the same way as for a charging attack. If the target's skill level is lower, add the modifier to the to-hit number. If the attacker's Piloting Skill level is lower, subtract the modifier from the to-hit number.

If the attack is successful, both BattleMechs take damage as determined below. If the attack misses, the jumping 'Mech crashes to the ground and takes damage (see *Falls*, below).

**Infantry:** For death from above attacks against infantry targets, add an additional +3 to-hit modifier. Also, because infantry units have no Piloting Skill, neither player needs to add a modifier for relative Piloting Skills.

## DAMAGE TO TARGET

To determine damage to the target from a death from above attack, divide the weight of the attacking BattleMech by 10 and multiply the result by 3, rounding up. For example, a Jenner with a weight of 35 tons inflicts 11 points of damage.

Group the damage into 5-point clusters in the same way as for LRM damage. Determine the attack direction as though the attack had come from the attacking BattleMech's starting hex, then determine the hit location of each cluster of damage by rolling 1D6 and consulting the BattleMech Punch Location Table, p. 39.

**Vehicles:** Resolve successful death from above attacks against a vehicle on the Front column of that vehicle's Hit Location Table.

## DAMAGE TO ATTACKER

The attacker takes damage as if from a successful attack on its legs. To determine the amount of damage, divide the attacker's weight by 5. Divide the result into 5-point clusters as for LRM damage, then roll 1D6 for each cluster of damage and consult the Front column of the BattleMech Kick Location Table to find the location hit.

## LOCATION AFTER ATTACK

At the end of a death from above attack, the attacker lands in the target's hex. If the DFA is successful, the target is pushed 1 hex in the direction opposite the attack. If the attack fails, the target chooses an adjacent hex and moves to it, even if immobile or prone. This motion might result in *Accidental Falls from Above* or a *Domino Effect*; see *Unit Displacement*, p. 44.

It may be impossible for the target unit to be displaced if all the surrounding hexes contain impassable terrain. For example, the target 'Mech may be on Level 0 terrain surrounded by Level 3 or higher hills. In this case, if the attack succeeds, the target is destroyed. If the attack fails, the attacker is destroyed. In both cases, the destruction is recorded as a Head Blown Off critical hit for purposes of salvage. In the case of vehicles, it is considered an ammo/power plant hit.

## DIFFERENT ELEVATIONS TABLE

### Target is:

Standing BattleMech 1 level higher  
 Standing BattleMech 1 level lower  
 Prone 'Mech, Vehicle or Infantry 1 level higher  
 Prone 'Mech, Vehicle or Infantry 1 level lower

### Allowed Physical Attack

Charge, Punch (use Kick table), or Club (use Kick table)  
 Charge, Kick (use Punch table), or Club (use Punch table)  
 Punch, Club  
 None

**Note:** A death from above attack can always be made if the BattleMech has the necessary Jumping MP.

## FALLS

A successful death from above attack may cause both BattleMechs to fall. Both MechWarriors must make Piloting Skill Rolls, the target adding a +2 modifier and the attacker adding a +4 modifier. If either unit fails this roll, the unit takes damage as from a 0-level fall.

On an unsuccessful attack, the attacker automatically falls, taking damage as though the 'Mech had fallen 2 elevation levels onto its back side (see *Falling*, p. 22).

## DIFFERENT ELEVATIONS

The rules for punching, clubbing, kicking and charging attacks assume that the opposing BattleMechs are at the same elevation. Most physical attacks against vehicles occur only if the vehicle is being attacked by a unit at the same elevation. See *Physical Attacks Against VTOLs*, p. 58, for exceptions.

A BattleMech may make a physical attack against another BattleMech only if both 'Mechs are within 1 elevation level of each other. The Different Elevations Table shows which types of physical attacks can be made in various situations. Note that players must use different Hit Location Tables to determine the location of damage from punching, clubbing, or kicking attacks against an opponent on various levels.

BattleMechs cannot make punch attacks against ground vehicles or infantry unless the BattleMech is 1 elevation level lower than normal because it is prone, on lower terrain, or standing in Depth 1 water.

## PRONE BATTLEMECHS

The following special rules apply to prone 'Mechs for physical attacks.

### PHYSICAL ATTACKS BY PRONE BATTLEMECHS

Prone BattleMechs can make only two types of physical attacks; punches against ground vehicles in the same hex and thrashing attacks against infantry.

#### Punching While Prone

In order to punch while prone, a 'Mech may not be suffering from a destroyed arm. Like *Firing When Down* (p. 31), the 'Mech props itself up on one arm and may punch once with the other arm. Vehicles take punch damage from prone attacks against the side facing the attacker.

#### Thrashing Attack

When a prone BattleMech and an infantry unit (armored or unarmored) occupy the same hex, the BattleMech may make a thrashing attack by wildly waving its arms and legs in hopes of making contact with the infantry. The attack can only be made in clear or paved terrain and is automatically successful. This attack inflicts damage on the infantry equal to the BattleMech's tonnage divided by 3 (round up at .5 or greater). Against battle armor, divide this damage into 5-point groups and determine hit location for each group (see *Attacks Against Battle Armor*, p. 61). If a BattleMech makes a thrashing attack, it cannot make any other attack in that turn, and the MechWarrior must make a Piloting Skill Roll to prevent damage to his BattleMech. If the pilot fails this roll, the BattleMech suffers normal falling damage as though it had failed an attempt to stand.

**Anti-'Mech Infantry:** Thrashing attacks cannot be made against infantry that are successfully swarming. Swarming infantry must be dislodged according to the *Anti-BattleMech Infantry* rules on p. 67.

## PHYSICAL ATTACKS AGAINST PRONE BATTLEMECHS

The only physical attacks that can be made against a prone BattleMech are kicks and death from above, plus charge attacks made by vehicles. BattleMechs cannot charge prone BattleMechs. Determine the location of successful attacks of these types using the appropriate column of the BattleMech Hit Location Table, p. 33. Note that damage from death from above attacks against prone 'Mechs is determined using the Rear column of the table, regardless of the attack direction.

**Different Elevations:** A prone BattleMech that is 1 level higher than the attacking 'Mech can also be hit by punch and club attacks. These attacks also use the BattleMech Hit Location Table.

## UNIT DISPLACEMENT

Units that are moved from their hexes as a result of their opponent's actions are said to be displaced. Displacement can result from charging, pushing and death from above attacks. It can also result from a so-called domino effect as a string of units are displaced into one another.

A unit cannot be displaced into a hex that is impassable to it (see Movement Cost Table, p. 18). This includes hexes that are more elevations upward than the displaced unit can cross using Walking/Cruising movement. Of course, units can be dis-

placed downward any number of levels, though this results in an accidental fall (see below).

If the rules call for a unit to be displaced into an illegal hex, the displacement cannot occur. Unless the specific rules of the attack or action state otherwise, in these cases neither the target unit nor the attacking unit is moved. All other usual effects of the displacing action take place, including damage and any required Piloting Skill Rolls.

**Vehicles:** A vehicle unit can be displaced into water. If the water is impassable to the vehicle type, then the vehicle is destroyed.

## ACCIDENTAL FALLS FROM ABOVE

An accidental fall from above results when a unit is displaced by a charge, push, or death from above attack, or as a result of another accidental fall from above or the *Domino Effect* (p. 45) into a hex containing another unit, and the elevation of the hex it is entering is 2 levels or more lower than the hex it was displaced from. If the elevation is 1 or 0 less, or greater than, the level of the hex it was displaced from, a domino effect occurs instead.

When a BattleMech accidentally falls 2 levels or more into a hex occupied by another BattleMech, make a to-hit roll with a Base To-Hit Number of 7, modified by target movement and terrain only.

A BattleMech may not intentionally "accidentally" fall from above.

**Infantry:** Accidental falls automatically miss infantry.

**Vehicles:** Accidental falls automatically hit vehicles.

## Falling BattleMech Hits Target

If the to-hit roll is successful (or if the target unit is a vehicle), treat the accidental fall as a successful death from above attack, with the following exceptions. If the "target" unit is a BattleMech, the falling 'Mech takes damage to its upper body. If there is more than one non infantry unit in the target hex (friend or foe), determine randomly which will be the target unit.

Determine the amount of damage inflicted on the target unit by dividing the weight of the falling BattleMech by 10. Divide the damage into 5-point clusters, then roll 1D6 for each cluster of damage and consult the BattleMech Punch Location Table. Determine damage to the falling ("attacking") BattleMech as normal for a fall, with the BattleMech falling on its back.

## Falling BattleMech Misses Target

If the to-hit roll is not successful, the falling BattleMech lands in an adjacent hex, as close to the hex that it fell from as possible, and takes the standard damage from falling. No other units take damage.

If there are multiple adjacent hexes equally close to the hex the unit fell from, randomly determine which hex is entered.

## DOMINO EFFECT

A domino effect results when a unit is displaced by a charge, push, or death from above attack, or as a result of another domino effect or *Accidental Falls from Above* (p. 45), into a hex containing another unit, and the elevation of the hex it is entering is 1 or 0 levels lower than the hex it was displaced from, or higher than the hex it was displaced from. Furthermore, the domino effect only results if the stacking limit of the hex would be exceeded by the new unit entering the hex.

If a BattleMech accidentally falls 1 level or less, or is forced into a hex occupied by another BattleMech, the second BattleMech is normally forced out of the hex in the direction of the push. The second BattleMech can avoid this by moving out of the hex, as long as it is neither facing the first BattleMech nor facing directly away from it.

The pilots of both BattleMechs must make Piloting Skill Rolls to avoid falling. When the domino effect push originates from one of a BattleMech's four side hexes, however, the BattleMech can avoid the domino effect by moving 1 hex directly forward or back, if it has sufficient MP remaining from the Movement Phase, if it is both mobile and standing, and if the player made a successful Piloting Skill Roll for that BattleMech. If the Piloting Skill Roll was not successful, the BattleMech would have fallen and missed this chance to step out of the way.

The domino effect continues as long as BattleMechs remain in hexes adjacent to one another in the direction of the effect, and none of them manages to step out of the way.

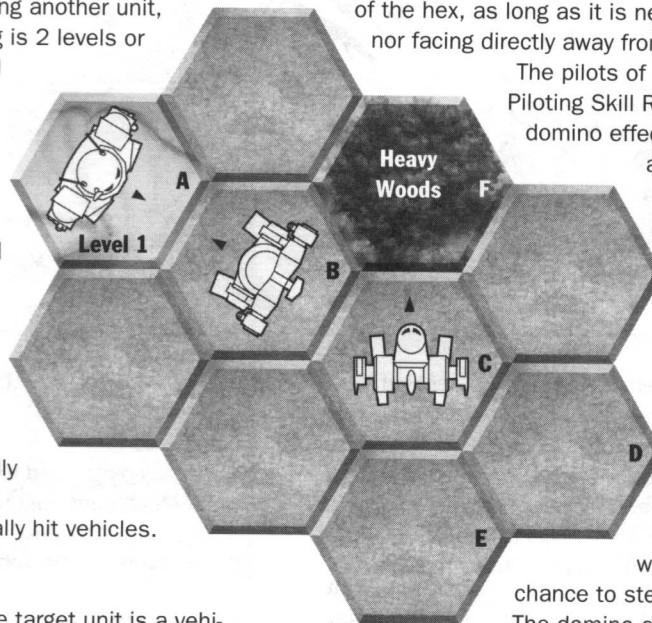

*The BattleMech in Hex A has fallen 1 level into Hex B. The BattleMech standing in Hex B will be forced into Hex C and must make a Piloting Skill Roll to avoid falling. The BattleMech in Hex C, however, can try to avoid the domino effect by moving. First, the player must make a Piloting Skill Roll. If the roll fails, the 'Mech will fall into Hex D, and if another 'Mech occupied that hex, the domino effect would continue. However, if the roll is successful and the 'Mech has at least 1 MP left from the previous Movement Phase, it may move one hex directly backward, into Hex E, ending the domino effect. If the BattleMech had 3 or more MP left, it could choose to move forward into the heavy woods in Hex F.*

## HEAT

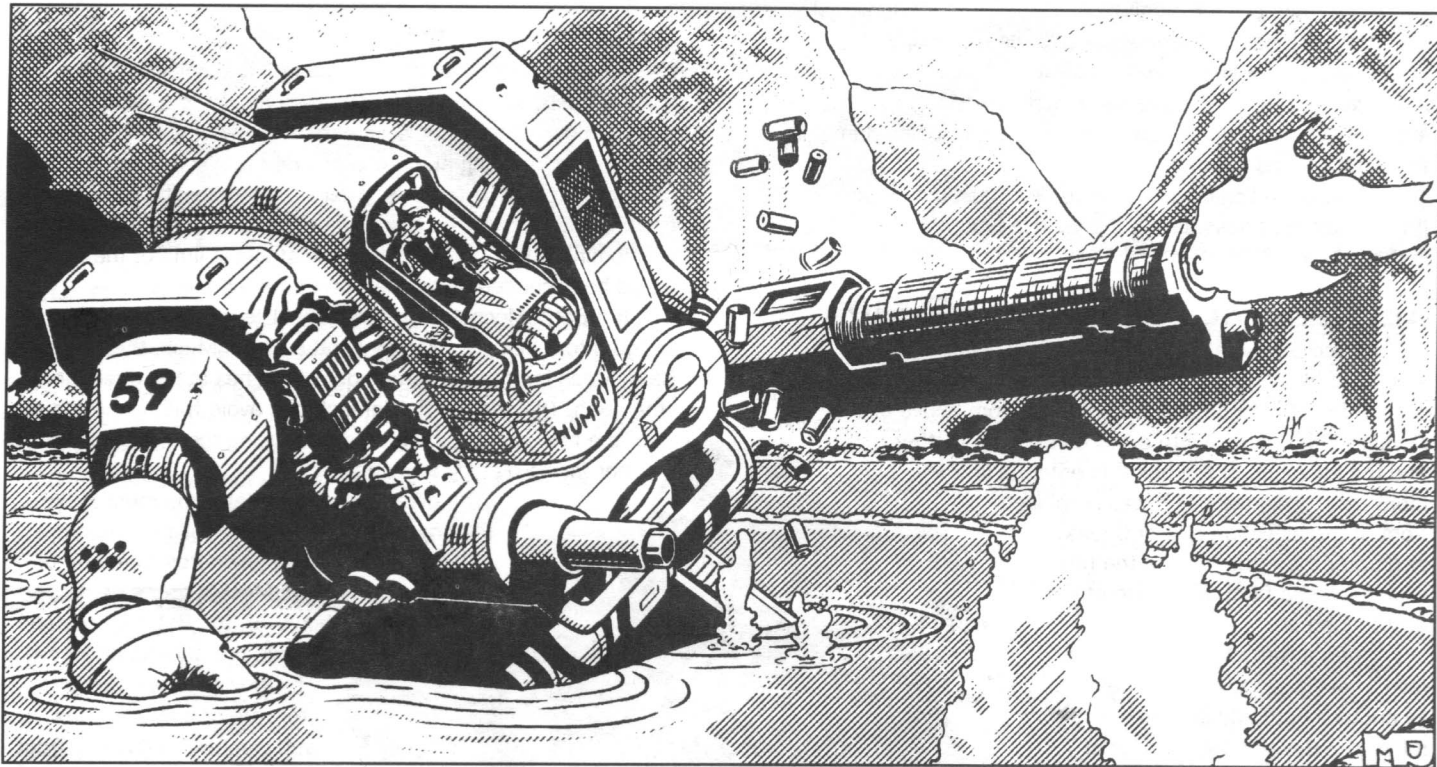

One of the most severe problems facing any BattleMech in combat is internal heat buildup. Though every BattleMech can dissipate heat through its heat sinks (devices designed to draw heat away from thermal systems) or by standing in water, the BattleMech builds up heat whenever it moves or fires its weapons.

Even when using both of those methods to cool its systems, a high rate of activity commonly produces more heat than a BattleMech can dissipate. It is possible for a BattleMech to overheat and continue to function, but a pilot who pushes his BattleMech past its limits eventually must pay the price. As a BattleMech's internal heat increases, it moves more slowly and its weapons fire becomes less accurate. If its internal heat reaches a certain level, the ammunition that it carries may explode. The BattleMech's fusion reactor may even shut down, causing the BattleMech to become inactive and immobile until the heat drops below a certain point.

**Vehicles:** Vehicles do not generate heat in the same manner as BattleMechs. A vehicle only needs to be designed with enough heat sinks to fire all of its energy weapons at once. Because of its more open (and flimsier) structure, a vehicle can automatically shed heat built up from movement or from firing non-energy weapons.

### HEAT POINTS

Players track the internal heat of a BattleMech by the number of Heat Points (HP) it builds up. The greater the number of Heat Points, the greater the 'Mech's internal heat. The player

keeps track of his BattleMech's Heat Points using the column of boxes on the 'Mech record sheet labeled Heat Scale. The Heat Scale records heat levels from 0 to 30 Heat Points. The Heat Overflow box is used to track heat levels above 30. As the BattleMech's internal heat reaches various levels on the Heat Scale, the BattleMech will suffer the adverse effects listed at those levels on the scale.

### BUILDING UP HEAT

Different activities build up heat at different rates. A good MechWarrior balances the tactical value of an activity against the heat it will add to his BattleMech. The Heat Point Table indicates the number of Heat Points generated by various activities and damage. It also shows the number of Heat Points that a BattleMech can dissipate through its heat sinks and by standing in a Water hex. Note that there are two types of heat sinks available: standard heat sinks that dissipate 1 point of heat per turn, and double heat sinks that dissipate 2 points of heat per turn.

**Jumping:** Note that jumping generates more heat than walking or running, even if the BattleMech moves only 1 hex, because firing the jump jets adds a minimum of 3 Heat Points. The Heat Point cost for jumping depends on the length of the jump. The farther the jump, the longer the jump jets are used and the more heat they generate. To determine the number of Heat Points generated by jumping, count the hexes moved. If the 'Mech jumps 3 or fewer hexes, the Heat Point cost is 3 points. If the number of hexes moved is 4 or more, the Heat Points generated equals the number of hexes jumped.

**Water:** Heat sinks dissipate twice as much heat when they are underwater in the Heat Phase. When a BattleMech is standing in Depth 1 water, only those heat sinks mounted in the legs are underwater. A 'Mech standing in Depth 2 or deeper water or prone in Depth 1 or deeper water is completely submerged, so all of its heat sinks are considered underwater. Regardless of how many heat sinks are underwater, however, the 'Mech can shed no more than an additional 6 points of heat per turn by being underwater.

**Shutting Off Heat Sinks:** A MechWarrior may actually wish to build up heat in some situations, particularly if his BattleMech is equipped with triple-strength myomer (p. 134). Building up heat is most easily accomplished by shutting off as many heat sinks as desired during the End Phase of any turn. Heat sinks shut off in such a way dissipate no heat in the following Heat Phase and may only be switched back on during a subsequent End Phase.

## HEAT POINT TABLE

Activity	Heat Points
Walking	+1 per turn
Running	+2 per turn
Jumping	+1 per hex (minimum of 3 per turn)
Attempting to Stand	+1 per attempt
Weapons Fire	Per Weapons and Equipment Tables, p. 115
Heat Sink	-1 per operational heat sink -2 per operational double heat sink -1 additional per heat sink under water (maximum 6 points) -2 additional per double heat sink underwater (maximum 6 points)
First Engine Hit	+5 per turn
Second Engine Hit	+10 (total) per turn
Fire	
Walking through	+2 per hex
Standing in	+5 per turn

## RECORDING HEAT BUILDUP

During the Heat Phase of every turn, each player adds up the Heat Points built up by his BattleMech. He subtracts the heat dissipated by his BattleMech's heat sinks and any additional dissipation if his BattleMech occupies a Water hex. The result may be positive or negative. Add this number to the current level of heat shown on the Heat Scale on the BattleMech's record sheet. If the number is negative, adjust the Heat Scale downward; if the result is positive, adjust the Heat Scale upward. The level of heat shown on the Heat Scale cannot drop below 0.

We suggest that players mark the Heat Scale with a pencil, because the heat will rise and fall many times during the game.

**More than 30 Heat Points:** It is possible for a 'Mech's heat level to rise above 30. Heat in excess of 30 has no additional

effect on the 'Mech beyond the power plant shutdown at 30 points of heat, but the excess heat makes it take longer to restart the 'Mech, because the heat level must drop below 30 before the 'Mech's reactor can be started. Mark any heat generated beyond 30 in the Heat Overflow box on the record sheet. If there is no Heat Overflow box on the record sheet being used, simply write the extra heat at the top of the Heat Scale. When dissipating heat, the Heat Overflow must be dissipated before the Heat Scale can be reduced below 30.

## EFFECTS OF HEAT

The effects of excessive heat cause the BattleMech to function less efficiently. It will move more slowly, fire less accurately and possibly shut down or even explode. Some of these effects are permanent, but others are negated when the 'Mech cools.

The BattleMech suffers the effects listed below after the heat level for the turn has been adjusted as described in *Recording Heat Buildup*.

## MOVEMENT EFFECTS

At 5, 10, 15, 20 and 25 Heat Points, subtract the number indicated from the BattleMech's Walking MP. For example, at 5 Heat Points, subtract 1 from the BattleMech's Walking MP as long as the heat is at or above 5. Remember that Running MP are 1.5 times the current Walking MP; if the Walking MP are reduced, the BattleMech's Running MP must also be recalculated, rounding fractions up.

This effect is not cumulative with any previous heat-caused loss of Movement Points. When a BattleMech's heat buildup reaches 5 on the Heat Scale, its Walking MP are reduced by 1. When the buildup reaches 10 on the Heat Scale, its Walking MP are reduced by 2 total, not 2 more.

When the heat buildup is reduced below the point at which the effect occurs, the BattleMech regains 1 Walking MP, though previous losses remain in force. Thus, if the heat falls below 10 on the Heat Scale, the -2 MP effect is removed, but the -1 MP effect is still in force until the heat drops below 5.

**Jumping:** Note that a BattleMech's Jumping MP are not affected by the reduction in Walking MP due to heat buildup.

## WEAPON ATTACK EFFECTS

At 8, 13, 17 and 24 Heat Points, add the number indicated to the BattleMech's base to-hit number for weapon attacks. For example, at 8 Heat Points, add 1 to all base to-hit numbers while the heat is at or above 8. Treat these effects like movement effects: they are not cumulative and may be negated by reducing the heat buildup.

## SHUTDOWN EFFECTS

At 14, 18, 22, 26 and 30 Heat Points, a BattleMech attempts to shut down its fusion reactor automatically as a safety procedure. Until the MechWarrior restarts the reactor, the BattleMech is affected by shutdown as described in *Shutdown BattleMechs*, below.

This effect may be avoided if the MechWarrior is able to override the fusion reactor's safety shutdown procedure, as



indicated by the Avoid number listed with the effect (shutdown cannot be avoided at 30+ Heat Points). The player rolls 2D6 once during the Heat Phase if the 'Mech's heat is at or above 14. If the result is equal to or greater than the highest Avoid number corresponding to his 'Mech's heat level, the pilot avoids shutdown for that turn. If heat accumulation reaches 2 or more trigger levels in one turn, roll 2D6 only once, against the highest Avoid number.

### Shutdown BattleMechs

When a BattleMech shuts down, it can take no actions, and all of its equipment ceases to function. (See also Piloting Skill Table, p. 23). It cannot make attacks or move, and cannot build up heat by its own actions. Even engine critical hits will not generate extra heat while the 'Mech is shut down. Outside influences such as fire and flamers can create heat buildup, however.

A shutdown BattleMech's heat sinks will still work and so will continue to dissipate the excess heat. For every turn that the 'Mech is shut down, the heat level will drop as usual, and the player may attempt to restart the reactor during each Heat Phase. To do this, the player rolls 2D6. If the result is equal to or greater than the highest current Avoid number, he can restart the reactor. A BattleMech may move and fire in the turn following the turn in which the reactor was restarted. When the heat drops below 14 on the Heat Scale, the reactor restarts automatically, even if the pilot is out of action.

**Aimed Shots:** A shutdown BattleMech may be targeted by aimed shots (p. 33).

### AMMUNITION EFFECTS

If the heat level reaches or exceeds an Ammo Explosion threshold of 19, 23, or 28 Heat Points, the ammunition carried in the BattleMech might explode. The explosion may be avoided by pure luck, as indicated by the Avoid number. To see if the 'Mech avoids an explosion when the heat level reaches an Ammo Explosion threshold, the player rolls 2D6 once during the Heat Phase if the 'Mech's heat is at or above 19. If the result is equal to or greater than the highest Avoid number corresponding to his 'Mech's heat level, the pilot avoids an ammunition explosion for that turn. If heat accumulation reaches 2 or more trigger levels in one turn, roll 2D6 only once, against the highest Avoid number.

When a BattleMech's ammo explodes due to overheating, the ammunition critical slot with the most destructive ammo rack explodes first. An ammo rack is defined as the damage that one turn's worth of shots will do. Thus, a rack of machine gun ammo has a Damage Value of 2, an AC/10's Damage Value is 10, an LRM-15 has a Damage Value of 15, and an SRM-6 has a Damage Value of 12. When the 'Mech carries two racks with equivalent Damage Values, the BattleMech's pilot chooses which ammo explodes. All of the appropriate ammo type in a single critical hit slot explodes. If there is more than one critical hit slot with the appropriate ammo type, the one with the most shots remaining will explode. If there are two or more locations with an equal number of shots remaining, randomly determine the one that explodes.

Resolve the explosion following the rules in *BattleMech Critical Hit Effects*, p. 36.

### MECHWARRIOR EFFECTS

If the life-support systems suffer a critical hit, the MechWarrior suffers 1 point of damage for every turn that the BattleMech's internal heat reaches 15 or more. For every turn that the heat rises or remains higher than 25, the MechWarrior suffers 2 points of damage.

*A Hatamoto-chi begins a turn with a Heat Scale reading of 4. During the turn, it fires both its PPCs and walks (generating a total of 21 Heat Points). The BattleMech only has 16 standard heat sinks working. They dissipate 16 of the 21 Heat Points, leaving 5 to build up. During the Heat Phase, these 5 points are added to the 4 already on the Heat Scale, bringing the total to 9. In the next turn, the BattleMech must reduce its Walking MP by 1 and add +1 to its to-hit number for weapons attacks.*

*If the BattleMech repeats these actions in the next turn, the player must add 5 more Heat Points to the Heat Scale, bringing the total to 14. The player must roll a 4 or higher on 2D6 to avoid having his BattleMech's fusion reactor shut down. Even if he avoids the shutdown, he must reduce the Hatamoto-chi's Walking MP by 1 more, for a total of 2, until its heat falls below 10 on the Heat Scale. At the same time, the 'Mech fires its weapons with a +2 to-hit modifier.*



Illustration by Les Dorsfield

## THE STAR LEAGUE

In 2571, humanity united under the Star League, ushering in a golden age of achievement and prosperity unsurpassed in history.

BAWTTLETECH ILLUSTRATED HISTORY

Illustration by: Doug Andersen



## THE SUCCESSION WARS

Following the collapse of the Star League in 2781, brave soldiers followed their liege lords into savage wars that would last for centuries.

# BATTLETECH

## ILLUSTRATED HISTORY

Illustration by: Clint Langley



### THE CLAN INVASION

In 3050, the militaristic descendants of the once-proud Star League army struck like a hammer blow against the Houses of the Inner Sphere.

# BATTLETECH® ILLUSTRATED HISTORY

Illustration by: Mark Zug

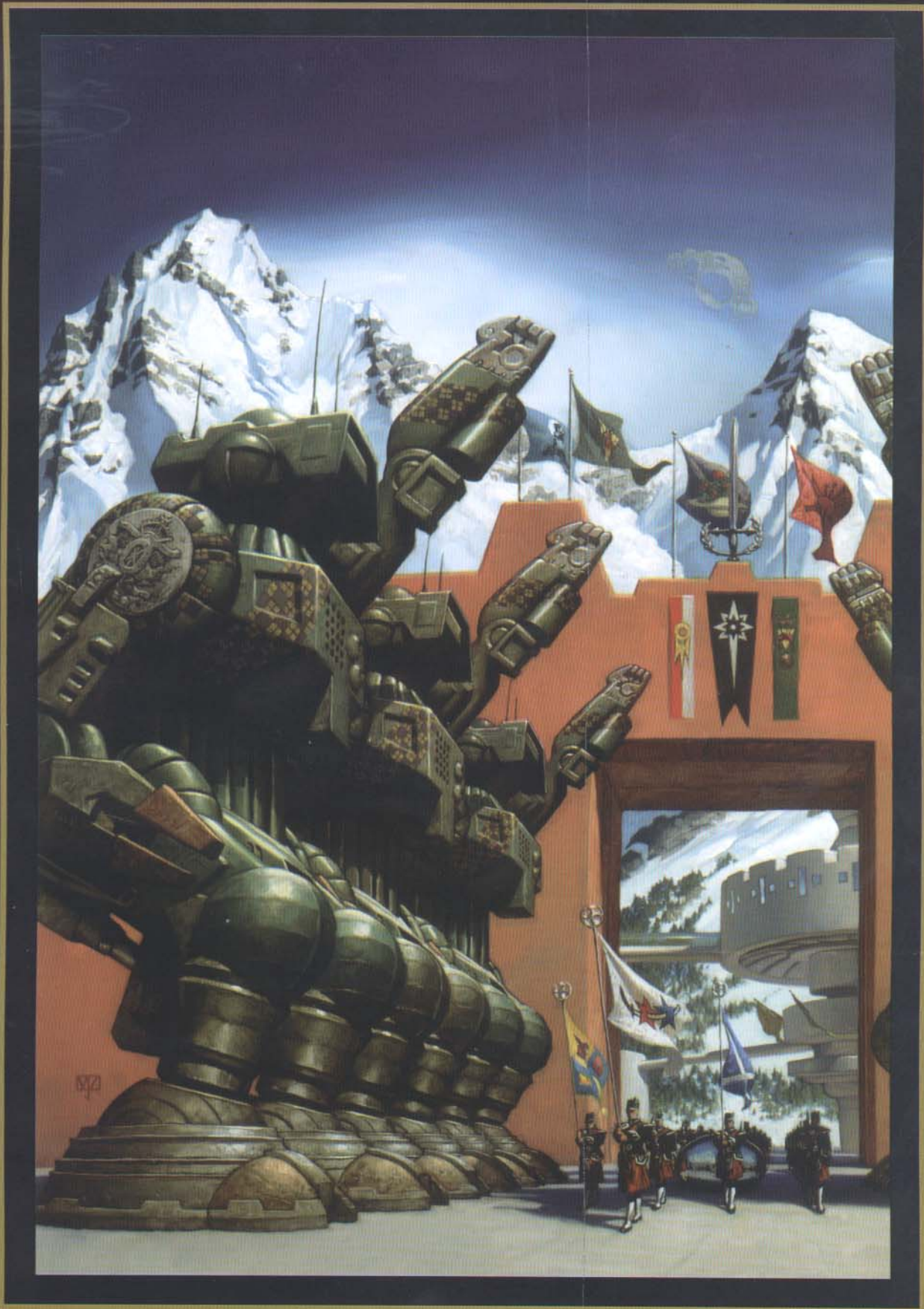

## A NEW ERA

The Star League re-formed in 3058 to fight a common foe, heralding the beginning of a bright new future.

## BUILDINGS

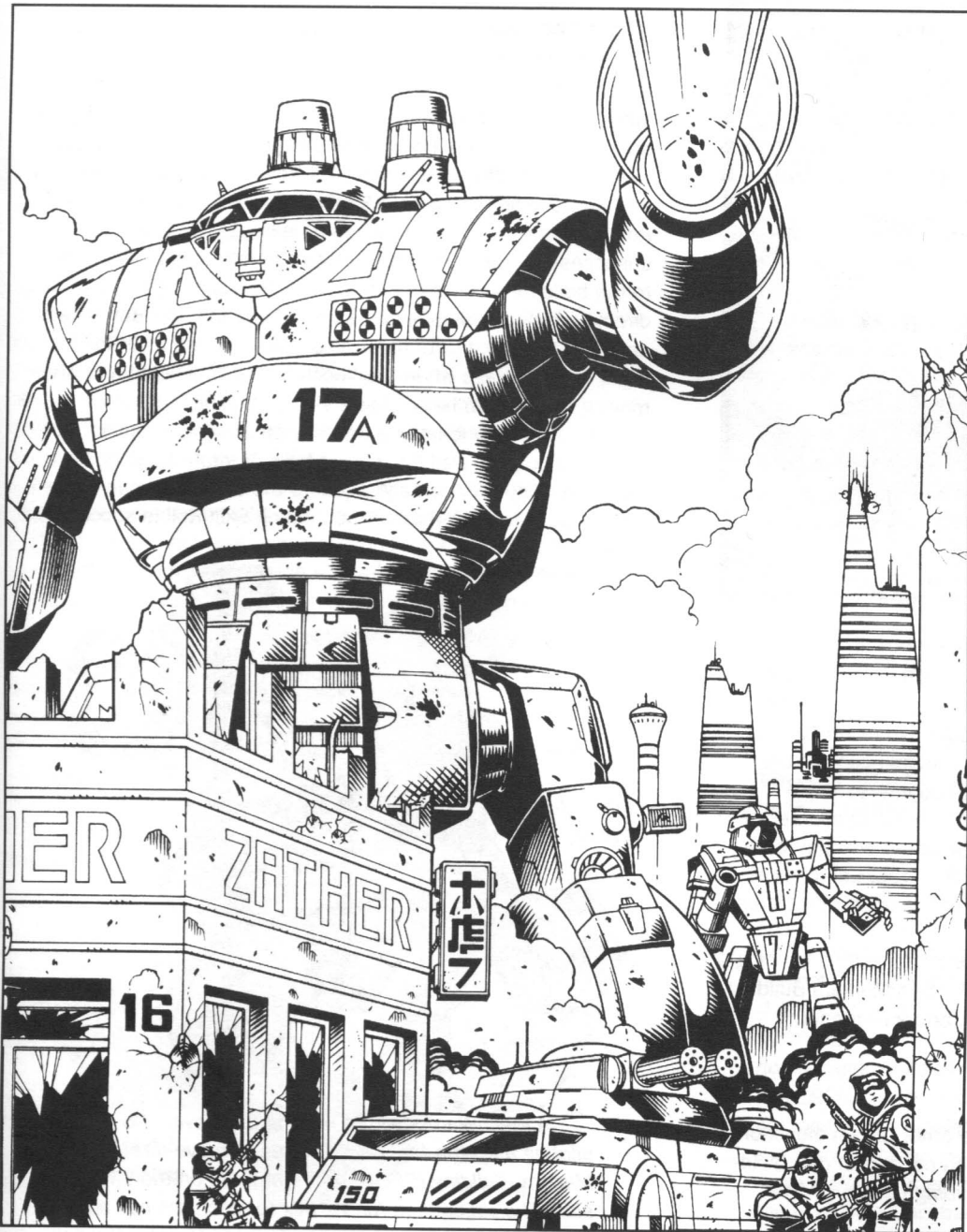

The rampant destruction caused during the early Succession Wars shocked and appalled even the most hardened soldiers. In recent years, it has become common practice to avoid combat in populated areas, especially among the warrior Clans, who consider the collateral damage caused by such battles unacceptable. Despite this unwritten law, combat still has a tendency to drift from the intended battlefield into urban areas. There is also no shortage of less than noble commanders who set ambushes in cities, counting on the unspoken truce in those areas to offer an extra measure of surprise.

Historically, the buildings and irregular terrain in urban areas made it difficult for armored vehicles to successfully achieve their objectives. Though BattleMechs have superior flexibility, cities still complicate warfare in the thirty-first century. Battles fought in long, narrow streets filled with buildings that block line of sight, provide enemy hiding places, and offer limited protection from weapons fire require a change in tactics and operations. In urban combat, even unarmored infantry may substantially damage a BattleMech.

The rules in this section are a simplified system for integrating basic buildings into *BattleTech* play. A more comprehensive system for other kinds of structures can be found in *Maximum Tech* on p. 49.

### BUILDING TYPES

*BattleTech* divides buildings into four types: Light, Medium, Heavy, and Hardened. Each type is rated to describe the damage it can withstand, the protection it provide, and the weight it can bear. Two numbers describe buildings in *BattleTech*: the Construction Factor (CF) and Elevation.

**Default Values:** If the scenario does not specify a building's type, assume it is Medium, Level 2.

### CONSTRUCTION FACTOR

The Construction Factor (CF) is used to determine how the physical structure of the building affects the play of the game. The CF is the number of points of damage that a building can take before being reduced to rubble. It is also the number of tons of additional weight each level of a building can support without collapsing. The range of possible CF values for each building type is shown on the Building Modifiers Table, p. 50. Regardless of a building's current Construction Factor, its type never changes. A damaged Heavy Building with a current CF of 15 is still a Heavy Building.

# BUILDINGS

## BUILDING MODIFIERS TABLE

Building Type	Original CF	MP Cost*	Piloting Skill Modifier
Light	1-15	2	0
Medium	16-40	3	+1
Heavy	41-90	4	+2
Hardened	91-150	5	+5

\* Infantry pay only 1 MP to enter a Building hex, regardless of type.

## BUILDING MOVEMENT MODIFIERS TABLE

Hexes Moved in Turn	Piloting Skill Modifier
1-2	0
3-4	+1
5-6	+2
7-9	+3
10+	+4

Building counters are used to represent buildings on the mapsheet. Counters provided by FASA show a picture of the intact building on one side, labeled according to its type and elevation. The other side represents rubble. Whatever players choose to use as counters, those pieces should contain the same information as is provided on FASA counters.

**Multiple-Hex Buildings:** In the case of building counters that cover more than a single hex, the CF of the building represents the whole counter, not its individual hexes. Each hex of the building can support tonnage equal to the building's current CF.

**Default Values:** If the scenario does not specify a building's CF, assume that a Light Building has CF 15, a Medium Building has CF 40, a Heavy Building has CF 90, and a Hardened Building has CF 120.

## BUILDING ELEVATION

Treat building elevation exactly like other terrain elevation for both line of sight and movement, with each level of a building being about 6 meters high. See *Building Levels*, p. 51.

## MOVEMENT EFFECTS

Units can move into or onto buildings. Building elevation levels affect movement in the same way as all other terrain elevation, though units may also enter a building rather than climbing on top (see *Entering Buildings*, p. 50).

If the total tonnage of 'Mechs and vehicles on any level of a building (except the ground floor, Level 0) exceeds the current CF of the building, the building will immediately collapse (see *Collapse*, p. 52).

The Building Modifiers Table summarizes movement costs and modifiers for each type of building.

**Vehicles:** Ground vehicles cannot move onto the top of a building.

## ENTERING BUILDINGS

Every time a BattleMech or vehicle moves into a building (by entering a Building hex), it passes through a wall, and the MechWarrior or driver must make a Piloting Skill Roll, adding all appropriate modifiers from the Piloting Skill Roll Table, p. 23. In addition, modify the Piloting Skill Roll for the unit's movement per the Building Movement Modifiers Table. If the Piloting Skill Roll is successful, the unit takes no damage. If the roll is unsuccessful, the BattleMech or vehicle takes damage equal to the building's current CF divided by 10 (round up). The attack direction for this damage is the front. Note that the BattleMech does not fall. The player must also make Piloting Skill Roll to avoid such damage when the 'Mech leaves a building and when moving from hex to hex inside a single building.

In addition, whenever a BattleMech or vehicle moves through a building wall (by moving from or into a Building hex), the building suffers damage equal to the unit's tonnage divided by 10 (rounded up), whether the Piloting Skill Roll is successful or not.

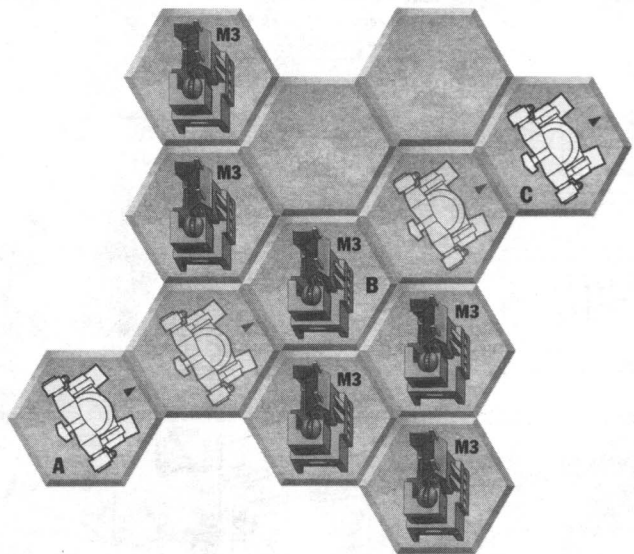

A MechWarrior with a Piloting Skill level of 5 piloting a 65-ton JagerMech wants to move through a Medium Building (CF 40) to fire at units on the other side. The JagerMech runs 1 hex to reach the hex adjacent to the building, then spends 3 MP to enter the hex containing the building. As the 'Mech passes through one wall, the player must make a Piloting Skill Roll, modified by +1 because this is a Medium Building ( $5 + 1 = 6$ ). As shown on the Building Movement Modifiers Table, the player need not add a modifier for its unit's movement because the JagerMech only moved 2 hexes so far. The JagerMech's player rolls 2D6 with a result of 10, which is a success. The BattleMech suffers no damage, but the building takes 7 points of damage (the JagerMech's 65 tons divided by 10 and rounded

up). The JagerMech must make a second Piloting Skill Roll in order to leave the Building hex. The player must add a Building Movement Modifier of +1 this time, because this is the 'Mech's third hex of movement ( $5 + 1 + 1 = 7$ ). The die roll result is 3, less than the 7 needed to pass through the wall without taking damage. The JagerMech suffers 4 points of damage (the current CF of 33, divided by 10, rounded up), and the building suffers a further 7 points of damage, reducing the current CF to 26. The JagerMech spends its remaining 1 MP to move to Hex C.

## Building Levels

Like terrain elevation, building elevation levels are 6 meters high. These levels do not represent a specific number of floors, but rather are used for game purposes as an abstraction of the actual contents of the building. For example, even though a BattleMech stands two levels tall, when inside a building, it only occupies a single level at a time.

All units can enter buildings at Level 0, or ground level. A BattleMech or infantry unit may enter a building at an elevation higher than ground level only if entering the building from an adjacent hex with an elevation equivalent to the building level being entered. Once inside a building, a BattleMech may not change elevations within the building.

**Vehicles:** Ground vehicles can only enter or exit the ground level (Level 0) of a building. They cannot change levels within a building.

**Infantry:** It costs infantry 1 MP to enter a building and 1 MP to change levels within a building.

**Stacking:** Normal stacking limitations are in effect at each level in a building. Interior floors of a building also can support the building's CF in tonnage.

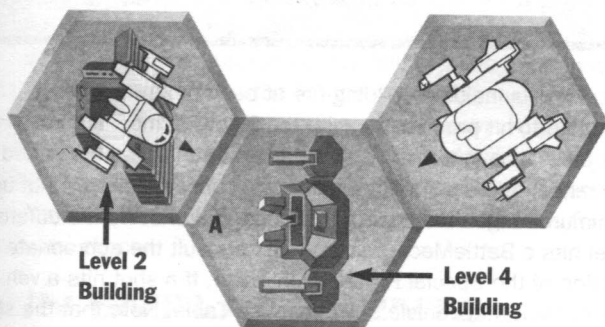

A Dragonfly is adjacent to the Level 4 building in Hex A. The Dragonfly may attempt to enter the building at ground level, or it may jump up to the roof. The Jenner on the roof of the adjacent Level 2 building may jump or climb to the roof of the building in Hex A, or it may enter the building on its second level.

## COMBAT EFFECTS

Combat in and around buildings may cause damage to the buildings and to the units inside.

## ATTACKING BUILDINGS

Units firing directly at a building add a -4 to-hit modifier for firing at an immobile target. Shots aimed at buildings from adjacent hexes always hit, as do all physical attacks. All missiles launched at a building from an adjacent hex will strike the building; the player need not roll on the Missile Hits Table.

When a building suffers damage, simply subtract the points of damage from the building's current CF and write the resulting number in pencil on the back side of the counter or on a piece of scratch paper. When the cumulative damage equals or exceeds the building's CF, flip the counter over to the rubble side. The building is now rubble for the rest of the game.

## ATTACKING UNITS INSIDE BUILDINGS

A unit firing at a BattleMech or vehicle that is inside a building does not modify the to-hit number to represent this situation, but the building provides some protection against damage to those 'Mech and vehicle units inside. (Infantry are a special case; see *Infantry Inside Buildings*, p. 51) The building absorbs an amount of damage equal to its current Construction Factor divided by 10 (round up) from each attack that hits a unit inside the building. For this purpose, an attack is each individual group of damage for which the attacker would make a hit location roll, including clusters of LRM and artillery damage and LB-X autocannon "pellets." The building absorbs the same amount of damage from each attack. The building takes damage (reduces its CF) only after all weapons fire is complete.

All shots that were aimed at a target inside a building and miss do full damage to the building instead.

**Physical Attacks:** Physical attacks cannot be made against targets in a building by units outside the building.

*Several attackers make successful attacks against a Hunchback that is inside a Medium Building, hitting it with an AC/10, a small laser, a large laser and 9 missiles from an LRM-15. The building has a current CF of 38. Each attack's damage is reduced by 4 ( $38 \div 10 = 3.8$ , rounded up to 4). The AC/10 inflicts 6 damage on the Hunchback. The small laser inflicts no damage, while the large laser inflicts 4 damage. The LRM damage is divided into a 5-point cluster of damage and a 4-point cluster of damage. One point of the 5-point cluster reaches the Hunchback, while the 4-point cluster is entirely absorbed by the building. In the end, the Hunchback suffers a total of 11 damage, while the building's CF was reduced from 38 to 19 ( $38 - 4 - 3 - 4 - 4 - 4 = 19$ ).*

## Infantry Inside Buildings

Because buildings block line of sight, units outside a building cannot fire directly at infantry (standard or battle armor) inside a building and must fire at the building instead. Damage done to buildings affects the infantry units inside according to the Infantry Damage in Buildings Table (round up at .5).

Use this table only when damage is intentionally inflicted on the building from a weapon or physical attack, or from a

# BUILDINGS

## INFANTRY DAMAGE IN BUILDINGS TABLE

Building Type	Damage to Infantry is:
Light	75% of damage to building
Medium	50% of damage to building
Heavy	25% of damage to building
Hardened	None

BattleMech or vehicle moving into or out of a building containing infantry. For damage to battle-armored troops inside a building, group the damage into 5-point clusters and roll 1D6 for each cluster to determine hit location (see *Attacks Against Battle Armor*, p. 61).

If an attacker is inside a building and in the same hex as an infantry unit, it may make a weapons attack against that unit, fire at the building, or make a direct physical attack against the unit.

*A 'Mech wishes to attack an infantry unit hiding in a Medium Building, so the 'Mech must attack the building rather than the infantry. The 'Mech inflicts 20 points of damage on the building, reducing its CF by 20. Ten points of damage (50 percent of damage to building) affect the infantry unit inside.*

## COMBAT WITHIN BUILDINGS

Units fighting inside a building must do so according to the following special rules. If the attacking unit is inside the building and on the same level, use the normal weapon- and physical-attack rules, but do not modify the to-hit number for the terrain.

It is possible for many units to occupy the same hex if they are on different levels of the same building. When units on dif-

## SPECIAL HIT LOCATION TABLE

Shot from Above	
Die Roll (1D6)	Hit Location
1	Left Arm
2	Front/Rear Left Torso*
3	Front/Rear Center Torso*
4	Front/Rear Right Torso*
5	Right Arm
6	Head
Shot from Below	
Die Roll (1D6)	Hit Location
1	Left Leg
2	Left Leg
3	Front/Rear Left Torso*
4	Front/Rear Right Torso*
5	Right Leg
6	Right Leg

\* The attack hits the Front if from the front or the side. It hits the Rear if from the rear.

## BASEMENTS TABLE

Die Roll (2D6)	Effect
2	Double Basement. A BattleMech falls 2 levels. Apply all damage to the legs (use the Front column of the BattleMech Kick Location Table).
3	Basement. A BattleMech falls 1 level. Apply all damage to the legs (use the Front column of the BattleMech Kick Location Table).
4	Basement. A BattleMech falls 1 level (use the Front/Rear column of the BattleMech Hit Location Table).
5	No Basement.
6	No Basement.
7	No Basement.
8	No Basement.
9	Small Basement. Protects infantry from damage, but traps them if the building is destroyed while they are inside. No effect on BattleMechs.
10	Basement. A BattleMech falls 1 level (use the Front/Rear column of the BattleMech Hit Location Table).
11	Basement. A BattleMech falls 1 level head first (use the Front/Rear column of the BattleMech Punch Location Table).
12	Double Basement. A BattleMech falls 2 levels head first (use the Front/Rear column of the BattleMech Punch Location Table).

ferent levels inside a building fire at each other, use the standard to-hit procedures, with the following modifications. The difference in levels between attacker and target is added to the range. Add a +3 to-hit modifier for concealment. Do not use minimum range modifiers in this case. If a shot from a different level hits a BattleMech, roll 1D6 and consult the appropriate section of the Special Hit Location Table. If a shot hits a vehicle, consult that vehicle's Hit Location Table. Note that the shot hits a randomly determined side of the vehicle. Remember that the building protects all units from a certain amount of damage just as when the attack comes from outside the building (see *Attacking Units Inside Buildings*, p. 51).

**BattleMechs:** Do not add a level to a BattleMech's height when it is inside a building.

## COLLAPSE

A building will collapse if it takes total damage equal to or greater than its CF or if there are BattleMech and vehicle units on any one level of one hex of the building whose combined tonnage exceeds the current CF of the building.

# BUILDINGS

When a building collapses because its maximum weight limit has been exceeded, it collapses immediately. If it collapses due to damage from attacks, it collapses at the end of the attack phase in which the damage was inflicted.

When a building collapses, any unit inside suffers damage equal to the building's CF at the beginning of the current phase divided by 10, multiplied by the number of levels of building above the affected unit (round up). Units on top of a collapsing building suffer damage as though they were on the highest level inside it.

**BattleMechs:** A BattleMech occupying a level higher than 0 or the roof of a collapsing building suffers standard falling damage in addition to the damage caused by the collapse (see above).

**Infantry:** Infantry units suffer 3 times the normal damage caused by a collapsing building.

## BASEMENTS

Most buildings have basements, which can work to a BattleMech's advantage or disadvantage. For example, a heavy BattleMech might walk through a Light Building and unexpectedly crash through the floor, suffering damage. On the other hand, a BattleMech might be able to use a basement for partial cover. To determine if a building has a basement and the effect of a unit falling into a basement, roll 2D6 and consult the Basements Table whenever a unit enters a building.

Note that published scenario packs may state whether a building contains a basement and what type of basement it is. Only use the Basements Table if the scenario being played does not provide this information.

A unit falls through the floor and into a basement only if the unit's tonnage is greater than the building's current CF. A collapsed basement creates a sinkhole below the ground floor of the building. The depth of the sinkhole is equal to the number of levels of basement (either 1 or 2).

**Vehicles:** A vehicle takes normal falling damage when it falls into a basement; use the Front column of the vehicle's Hit Location Table if it moved forward into the basement, or the Rear column if it reversed into the basement. Any vehicle lacking flight capability that falls into a double basement is trapped there for the rest of the game. See the Basements Table for additional effects.

## GUN EMPLACEMENTS

A gun emplacement is a building designed to provide a weapons platform and protection for the crew manning those weapons. Treat a gun emplacement as a standard building with the following additional rules.

Any type of weapon can be housed in a gun emplacement. Within the limits of these rules, any number of weapon systems may be fixed in an emplacement or a turret (see *Turrets*, below).

Players may mount a weapon in an emplacement to fire into one of three fixed firing arcs: north, east, or west, as illustrated below.

## GUN EMPLACEMENT DAMAGE TABLE

Die Roll (2D6)	Effect
2	Critical Hit: All Weapons Destroyed
3	Turret Hit and Locked (or Normal Damage)
4-5	Turret Hit (or Normal Damage)
6-8	Building Takes Normal Damage
9-10	Turret Hit (or Normal Damage)
11	Turret Hit and Locked (or Normal Damage)
12	Crew Killed, Weapons Intact

The north fixed firing arc always lies toward the north side of the mapsheet.

In combat, treat a gun emplacement as a building of the appropriate CF. For example, treat a gun emplacement with a CF 45 as a Heavy Building. When a gun emplacement takes a hit, roll 2D6 and consult the Gun Emplacement Damage Table to determine the hit location.

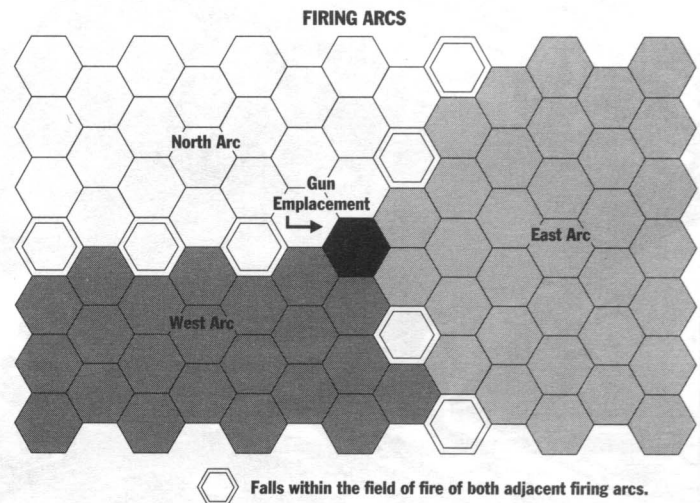

## TURRETS

Turrets have Armor Points separate from the CF of the emplacement itself.

Any number of weapon systems may be located in a turret, providing a 360-degree traverse and the same firing arcs as vehicles.

If a turret takes damage that locks it into place but leaves the weapons intact, it can fire those weapons into the firing arc of its last facing. If the turret takes damage exceeding its Armor Points, the turret and its weapons are destroyed, but any remaining weapons in the emplacement continue to function until the building itself is reduced to rubble. If the building has no turret and the die roll to determine hit location results in a 3-5 or 9-11, the building itself takes the damage.

# INFANTRY

A randomly chosen trooper takes maximum damage before the OmniMech takes damage from successful attacks. Only one trooper takes damage from any single hit intended for the OmniMech; damage in excess of that required to kill the trooper transfers to the OmniMech.

Only OmniMechs can carry battle armor units in this way.

## COMBAT

Rules for infantry combat are divided into two main categories: standard infantry combat (foot, motorized, or jump), and battle armor combat.

All types of infantry have a 360-degree arc of fire. Note that infantry may fire at units occupying the same hex. All damage from such attacks is considered to have an attack direction of Front. In addition, infantry never add attacker movement modifiers to their to-hit numbers.

## STANDARD INFANTRY

Standard infantry, also called conventional infantry or unarmored infantry, consist of platoons of troopers carrying hand-held weapons. Foot and motorized units consist of 28-man platoons. Jump units consist of 21-man platoons.

### Standard Infantry Attacks

Standard infantry units can be armed with one of five weapons: rifles, machine guns, flamers, portable lasers, or short-range missiles.

Use the BattleMech rules for infantry weapons fire and to-hit procedures, with the following modifications. Infantry units have Gunnery Skill (see *Warriors*, p. 14) and use the usual attack modifiers, with the exception of range modifiers. See the Infantry Range Modifier Table for the to-hit modifiers of standard infantry weapons by range.

The amount of damage that a standard infantry platoon can inflict is based on its current number of troopers and the type of weapons with which it is armed. Consult the Standard Infantry Damage Table to determine how much damage each type and strength of unit can inflict. For example, a full-strength rifle platoon inflicts 7 points of damage each time it successfully attacks, while an 11-man laser platoon does 6. This information also appears on the Infantry Record Sheet at the back of this book for ease of play.

Group standard infantry damage into 5-point clusters and apply in the same fashion as for LRM damage.

### Attacks Against Standard Infantry

Standard infantry platoons take damage in much the same manner as 'Mechs; attackers fire on infantry as normal units using appropriate modifiers, and infantry units take damage equal to the Damage Value of the weapon. As damage is taken, mark off the boxes indicating troopers on the platoon's record sheet, left to right, one for each Damage Point inflicted.

Unarmored infantry hit while in a Clear terrain hex suffer twice the normal damage.

For a standard infantry platoon that takes a hit from a vehicular or BattleMech-mounted machine gun, the attacking

## INFANTRY RANGE MODIFIER TABLE

Weapon Type	Range in Hexes (To-Hit Modifier)						
	0	1	2	3	4	5	6
Rifle	-2	0	+2	—	—	—	—
MG	-2	0	+2	+4	—	—	—
Flamer	-1	0	+2	—	—	—	—
Laser	-2	0	+2	+4	—	—	—
SRM	-1	0	0	+2	+2	+4	+4

## STANDARD INFANTRY DAMAGE TABLE

### Troopers Surviving (Platoon Type)

Laser or SRM	Machine Gun or Flamer	Rifle	Damage
			Inflicted
1-2	1-4	1-4	1
3-4	5-7	5-8	2
5-6	8-10	9-12	3
7-8	11-13	13-16	4
9-10	14-16	17-20	5
11-12	17-19	21-24	6
13-14	20-22	25-28	7
15-16	23-25	—	8
17-18	26-27	—	9
19-20	28	—	10
21-22	—	—	11
23-24	—	—	12
25-26	—	—	13
27-28	—	—	14

player rolls for damage based on the type of machine gun used. For a light machine gun, roll 1D6; for a medium machine gun, roll 2D6; for a heavy machine gun, roll 3D6. The result is the damage inflicted on the infantry platoon. Double this damage as usual if the infantry platoon is in Clear terrain.

Machine gun-equipped battle armor units that fire on an unarmored infantry platoon should roll 1D6 for each successful hit according to the Battle Armor Direct Fire Table. Add the die roll result for each hit to create a running total. This total is the damage inflicted on the unit. Double this damage as usual if the infantry platoon is in Clear terrain.

## BATTLE ARMOR

Battle armor infantry consist of small detachments of troopers equipped with powered combat suits, providing them with considerable armament, protection and mobility as compared with standard infantry. Clan battle armor units consist of 5-man Points, while the Inner Sphere typically deploys its battle armor in 4-man squads.

The following rules describe the use of Clan Elemental battle armor, the first-seen and most common type in use.

These rules apply, with only minor differences, to all types of battle armor. The variations in these rules for other types of battle armor are found in *Clan Battle Armor Variants* and *Inner Sphere Battle Suits*, pp. 61 and 63, respectively.

## Battle Armor Attacks

All members of a battle armor Point carry an SRM-2 launcher on their backs. The launcher holds four missiles, enough for two salvos of two missiles each. In addition, members of a Point carry one anti-BattleMech weapon system, either a small laser, a flamer, or a machine gun. All personnel in a Point must carry the same type of anti-BattleMech weapon system because they fire as a combined unit in battle.

When a Point of battle armor attacks, it fires as a single unit. In one Weapon Attack Phase, the Point may fire twice, once with SRMs and once with its second weapon (small laser, flamer, or machine gun). These attacks use all range and line-of-sight restrictions appropriate for the weapon. Note that battle armor small lasers are considered to be standard Inner Sphere models, not ER or pulse lasers. All attacks against units in the same hex as the battle armor unit are considered to be at a Range of 1.

Like all warriors, battle armor units have a Gunnery Skill rating (see *Warriors*, p. 14). Calculate the modified to-hit number using the standard rules, modifying the number for defender movement, terrain, and all other appropriate modifiers.

When an anti-BattleMech small laser, flamer, or machine gun attack hits its target, roll 2D6 and consult the Battle Armor Attack Table to determine the number of troopers in the Point who scored a hit. Each trooper who hits inflicts normal damage for the weapon. Determine a hit location separately for each hit.

**Anti-Mech Attacks:** Note that battle armor-equipped units are highly trained, elite troops and are automatically capable of delivering anti-BattleMech attacks as described in *Anti-BattleMech Infantry*, p. 67 in *Special Case Rules*.

If a battle armor unit makes a successful SRM attack, roll 2D6 and consult the Battle Armor Missiles Table to determine the number of missiles that hit. Each missile inflicts 2 points of damage on the target. Determine a separate hit location for each missile.

## Attacks Against Battle Armor

When a unit attacks a Point of battle armor, the attack targets the Point as a unit, though individual troopers take the damage (in other words, a single member of a Point cannot be the target of an attack; the trooper damaged by a successful attack is determined randomly). Use all standard modifiers. In addition, BattleMechs and vehicles must modify their to-hit numbers by +1 for battle armor attacks to account for the spread-out formation and tactics of battle armor units.

On a successful attack against battle armor, roll 1D6 to determine which one of the troopers takes damage from the hit (reroll a 6 or a result indicating a previously destroyed trooper). Treat long-range missile fire against battle armor as for BattleMechs; each cluster of missiles that hits the unit strikes a different, randomly selected trooper. Each weapon, SRM, or

## BATTLE ARMOR ATTACK TABLE

Dice Roll (2D6)	Troopers Active				
	1	2	3	4	5
2	1	1	1	1	1
3	1	1	1	2	2
4	1	1	2	2	2
5	1	1	2	2	3
6	1	1	2	2	3
7	1	2	2	3	3
8	1	2	2	3	4
9	1	2	3	3	4
10	1	2	3	4	4
11	1	2	3	4	5
12	1	2	3	4	5

## BATTLE ARMOR MISSILES TABLE

Dice Roll (2D6)	Troopers Active (Number of Missiles Fired)				
	1 (2)	2 (4)	3 (6)	4 (8)	5 (10)
2	1	1	2	2	3
3	1	2	2	3	3
4	1	2	3	3	4
5	1	2	3	4	6
6	1	2	4	4	6
7	1	3	4	5	6
8	2	3	4	5	6
9	2	3	5	6	8
10	2	3	5	7	8
11	2	4	6	8	10
12	2	4	6	8	10

cluster of LRMs or MRMs will only damage the trooper struck; excess damage is wasted.

Each suit of battle armor has an Armor Value of 10 points, plus an additional point of damage that represents the Elemental trooper inside. To inflict damage on the trooper, treat the eleventh point of damage as "armor" occupying a single "location." If all 11 points of armor are destroyed, the trooper inside the battle armor is out of action.

## CLAN BATTLE ARMOR VARIANTS

Early versions of Clan battle armor were tailored to specific combat roles and environments. Clan Wolf perfected the battle-suit known as Elemental battle armor, a compromise between the various types that was designed to function equally well in any environment and on virtually any type of mission. None of the earlier versions could match the Wolf suit's versatility, and so they faded into obscurity as Elemental battle armor gained wide acceptance among all the Clans.

Unexpectedly, the Clans' invasion of the Inner Sphere disturbed the status quo regarding battle armor. Initially, Clan

battle armor had no equivalent among Inner Sphere troops. In fact, Elementals were mistaken for alien invaders when first seen among Clan forces. However, as the Inner Sphere began to develop its own battle armor, the Clans started to lose their dominance in that field. In response, some Clans have begun to redevelop mission-specific battle armor to supplement the Elementals already in the field. The first two of these to see full-scale deployment are described below: the Hell's Horses heavy Gnome armor and Clan Fire Mandrill's incendiary Salamander suit.

Unless specified otherwise in the rules following each entry, this new battle armor follows all the standard battle armor rules.

## GNOME BATTLE ARMOR

In 3054, rumors filtered to the Clan homeworlds that the Inner Sphere was developing assault battle armor in order to counter the venerable Elemental design used by all Clans for the past century. Clan Hell's Horses, aware that any success in that field could threaten the edge they had long held over their fellow Clansmen as well as over the Inner Sphere, immediately set up a program to study the feasibility of such a concept. When the Clan's scientists, citing prototypes of pre-Elemental armor, demonstrated that assault battle armor was possible, Khan Malavai Fletcher ordered them to develop a similar system with Clan technology. The new armor, Fletcher insisted, had to retain its mobility, increase its firepower and be able to withstand all but the most powerful weapons.

The designers of the new battle armor dubbed it the Gnome, after an elemental being that inhabits earth. Using the latest techniques in small-scale, ferro-fibrous armor design, the Gnome mounts enough armor to withstand two strikes from Clan medium lasers. Its main armament is an extended-range small laser in the right arm, with a fully articulated claw on the left arm. In addition, the suit upgrades the Elemental's detachable SRM-2 launcher to an advanced model with increased range and accuracy.

### Gnome Armor Rules

Gnome units can jump up to 2 MP. Each Gnome battlesuit has an Armor Value of 14 points, plus 1 additional point that represents the trooper inside. Though Gnome troopers can jump and travel aboard OmniMechs using the Mechanized Battle Armor rules, they lack the dexterity to make anti-Mech leg or swarm attacks.

Unlike the weapons in the standard Elemental suit, those mounted in the Gnome are not modular. Every Gnome suit mounts a Clan ER small laser and an advanced SRM-2 launcher with two shots. The SRM-2 launcher has the range profile of Clan Streak SRMs (see p. 129). When rolling to determine the number of missile hits, roll on the standard Battle Armor Missiles Table. If the result of the roll indicates an odd number of missiles, add one missile to the result. For example, with five Point members active, a roll of 3 would indicate three missiles hit. However, because these are advanced missiles, the result is increased to four missiles.

## SALAMANDER BATTLE ARMOR

Clan Fire Mandrill scientists were intrigued by the concept of heavy battle armor but learned that Clan Hell's Horses had beaten them to the punch.

Rather than pouring resources into developing a technology they could gain through a Trial of Possession, a group of scientists from Kindraa Faraday-Tanaga decided to take a unique approach to their new battle armor design.

One of the early versions of Elemental



armor, named the Salamander after the elemental creature of fire, was designed specifically for urban warfare and anti-infantry operations, before unarmored infantry had fallen into disuse among the Clans. The Faraday-Tanaga scientists chose to model their new armor after this prototype while enhancing the suit's anti-'Mech capabilities. They eventually created a potent guerrilla fighter and counterinsurgency weapon.

As much a psychological as a physical weapon, the Salamander has a menacing look and a selection of weapons virtually guaranteed to break the will of any infantry that dares to stand against it. The Salamander's primary weapon is the flamer, which wreaks havoc with opposing infantry and can also be used to raise the heat levels of enemy 'Mechs. The Salamander carries a 'Mech-scale flamer underslung on each arm beneath a powerful claw for use in anti-'Mech swarm attacks. The suit's feet are also modified with gripping claws and magnets to aid in grabbing on to enemy 'Mechs. As an added anti-'Mech weapon, each Salamander suit carries a single inferno SRM, mounted over the shoulder in an insulated launch tube.

## Salamander Armor Rules

Salamander suits are armed with two flamers per trooper. Resolve the attack normally, but double the result from the Battle Armor Attack Table to determine how many flamers hit the target. Each suit also carries a single inferno SRM (see p. 131). A Salamander Point may fire its SRMs only once, determining the number of missile hits using the Battle Armor Attack Table.

Each Salamander battlesuit has an Armor Value of 7 points, plus 1 additional point that represents the trooper inside. Salamander units are immune to fire; they take no damage from flamers and are unaffected by inferno missiles and fires in their hexes.

Salamander suits have two powerful, articulated claws as well as clawed magnetic boots, making them extremely adept at anti-'Mech leg and swarm attacks. Apply a -1 modifier to the Base To-Hit number for such attacks. In addition, any attempt to remove swarming Salamanders, whether through punch attacks or jumping movement, suffers a +1 modifier to the target number.

## INNER SPHERE POWER SUITS

The Clans developed their battle armor in the middle of the thirtieth century, and immediately began using selective breeding techniques to develop a caste of Elemental pilots with the size, strength and agility to make the most effective use of battle armor. The Successor States have begun fielding their own versions of these suits, but Inner Sphere infantry lack the physical development to use them as effectively as their Clan opponents.

By 3059, the various Houses of the Inner Sphere have developed a number of distinct battle armor types. All of them follow the standard battle armor rules unless specifically stated otherwise below.

### STANDARD INNER SPHERE BATTLE ARMOR

The first attempts made by most Houses to copy Elemental battle armor took this form, including the Draconis Combine's Raiden suit and the Gray Death Legion's standard-issue power armor.

Such "standard" Inner Sphere battle armor functions in the same way as Elemental battle armor, but is somewhat weaker. To reflect this fundamental inequity, each Inner Sphere power-suited unit begins the game with only 9 points of armor, plus one additional point that represents the trooper inside. Inner Sphere power suits do not carry the heavy SRM launchers, so they are armed with only one anti-BattleMech weapon.

### GRAY DEATH LIGHT SCOUT ARMOR

The infamous mercenary outfit made some of the earliest strides in battle armor development. In addition to a standard model, the Legion has a "scout suit" that strips away half of the protection and the anti-Mech weapon of standard battle armor in exchange for increased mobility and a complex sensor array.

#### Scout Armor Rules

Gray Death scout armor units can jump up to 4 MP. Every light scout suit has an Armor Value of 4 points, plus 1 additional point that represents the trooper inside.

Scout armor units do not carry anti-'Mech weapons, but rather are armed like standard infantry. Therefore, they attack in the same way as unarmored infantry units, making a single attack with a single damage amount based on the unit's armaments and the number of surviving troopers.



Scout armor units can carry any standard infantry weapon. Scout armor units are also equipped with long-range communications gear and a sensor pack that functions like a Beagle active probe (p. 122).

## KAGE LIGHT BATTLE ARMOR

Developed with advice from Draconis Elite Strike Team (DEST) veterans, the Kage is intended for scouting missions. Ample speed and stealth were the Kage team's primary design considerations, with offensive capabilities a secondary consideration.

Originally, the Kage's designers intended to produce a powersuit with jump capability that exceeded the jump capabilities of most BattleMechs. The prototype's volatile flight characteristics presented a serious obstacle to this goal, but eventually the designers fitted the Kage with a partial-wing configuration and stabilizing fins that give the suit a maximum jump distance of 120 meters. When the unit is not jumping, the fins retract to reduce the powersuit's visibility and radar signature. The addition of stealth capabilities adapted from DEST sneak suits rounded out the Kage's abilities, turning it from an ordinary, fast infantry design to a true infiltration powersuit.

The standard Kage arsenal consists of a single antipersonnel weapon, mounted on the forearm for hands-free operation. Typically, one powersuit unit in every Kage squad is designated as a support unit and equipped with a single heavy weapon in place of the standard antipersonnel weapon. If a Kage squad is attached to a force equipped with Arrow IV launchers, the Kage support unit often carries a compact TAG spotting laser (see below) in place of a heavy weapon.

### Kage Armor Rules

Kage units can jump up to 4 MP.

Kage squads always consist of 4 troopers. The trooper designated as #1 on the record sheet is the squad's support unit and is equipped with one of the following anti-BattleMech weapons: flamer, small laser, machine gun, or compact TAG unit. The compact TAG operates exactly as a standard TAG, except its range is reduced to that of a medium laser (see TAG, p. 134). The weapon can be fired once per turn until trooper #1 is eliminated. The loss of trooper #1 means the unit has lost its

weapon, but it may still move and perform other battlefield tasks, such as spotting for LRM indirect fire or engaging in anti-BattleMech leg attacks per standard rules.

Every Kage powersuit has an Armor Value of 5 points plus 1 additional point that represents the trooper inside.

Kage suits are specially constructed to baffle all types of sensors, which makes long-distance targeting of those suits quite difficult. Medium-range attacks against Kage units receive a +3 to-hit modifier in place of the standard medium-range modifier; long-range attacks take a +6 to-hit modifier in place of the standard long-range modifier. Additionally, Beagle active probes and their Clan equivalents cannot locate hidden Kage units (see *Active Probe*, p. 122).

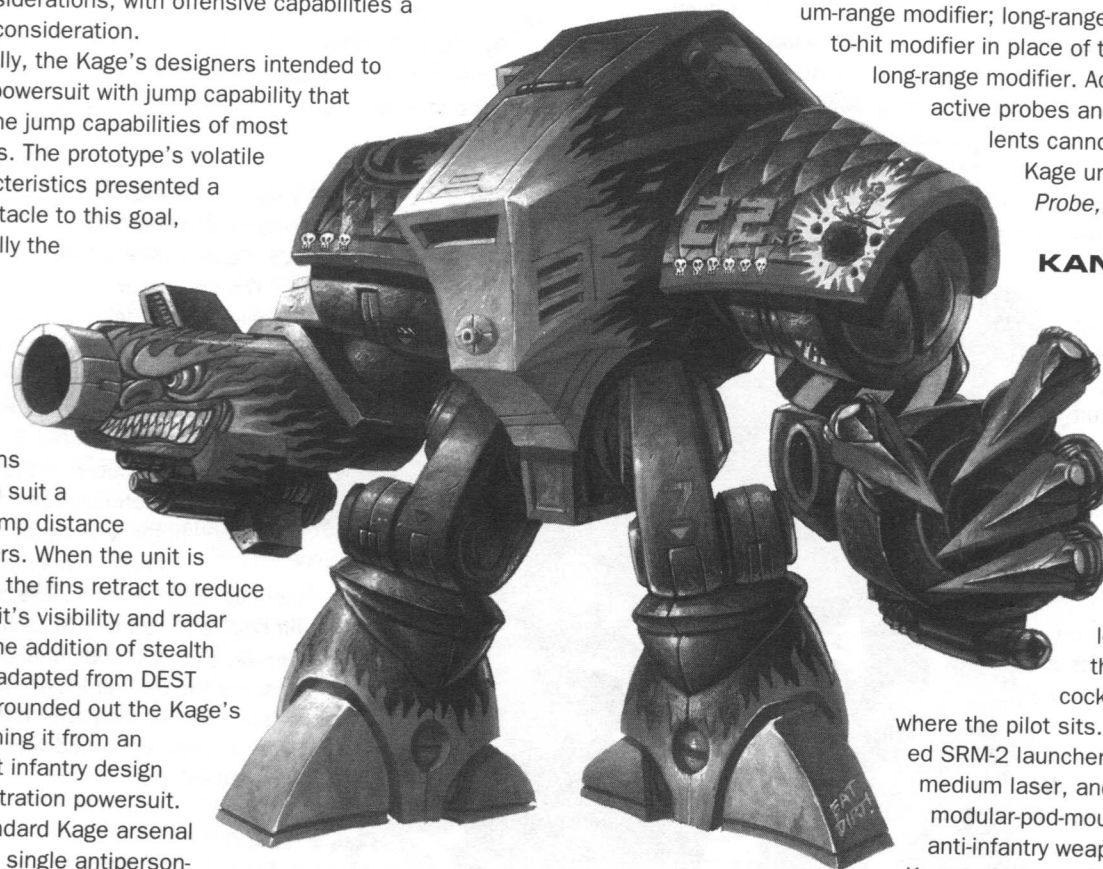

## KANAZUCHI ASSAULT BATTLE ARMOR

The Draconis Combine's Kanazuchi features large stumpy legs, thick arms, and a forward-leaning "head" that contains a cockpit-like section where the pilot sits. Twin back-mounted SRM-2 launchers, a 'Mech-sized medium laser, and a pair of modular-pod-mounted, secondary anti-infantry weapons compose the Kanazuchi's arsenal. The design

also features an impressive amount of armor. During the Kanazuchi's final field demonstration, in fact, the Draconis Combine Mustered Soldiery produced a captured Clan *Mad Cat* that unleashed a PPC blast directly at the powersuit. Though the blast virtually destroyed the powered armor, the pilot inside survived the hit relatively unhurt and even managed to return fire with two medium-laser bursts, much to the delight of the assembled observers.

Only a small number of Kanazuchi are currently deployed, and they are primarily used as defensive units because of their limited mobility.

### Kanazuchi Armor Rules

Kanazuchi battle armor units move at the same speed and with the same terrain restrictions as standard foot infantry (1 MP, no jump).

Each suit carries a single medium laser as its main weapon and two SRM-2 launchers. In any given turn, a Kanazuchi unit

may fire its medium laser, plus one or both of its SRM-2s. The SRM-2 racks have no reloads, so each rack can only be fired once per scenario.

Resolve the medium laser fire as a standard battle-armor attack. Resolve the SRM-2 shots as standard battle-armor missile attacks. If both SRM-2 racks are fired at the same time, they must be resolved separately. This means a full-strength Kanazuchi unit may make as many as three separate to-hit rolls in a single turn: one for the medium laser, one for the first salvo of SRMs, and a third for the second SRM salvo.

Each Kanazuchi powersuit has an armor value of 15 points plus 1 additional point that represents the trooper inside.

The physical construction of the Kanazuchi suits prevents them from climbing up onto a BattleMech, so they may not engage in anti-BattleMech leg or swarm attacks. For the same reason, Kanazuchi units cannot travel with an OmniMech using the Mechanized Battle Armor rules.

## LONGINUS BATTLE ARMOR

The Longinus suit represents the Free Worlds League Military's (FWLM) attempt to replicate the standard Clan Elemental battle armor. A joint effort by the FWLM and the Word of Blake enabled League

designers to create an impressive design, though the FWLM effort proceeded more slowly than the Federated Commonwealth and Draconis efforts to create battle armor. Unlike comparable DCMS and Federated Commonwealth designs, however, the Longinus features a version of the Clan Elementals' SRM launcher.

Capable of stopping a large laser or small-caliber autocannon hit, the Longinus met every criteria set by the League Central Coordination and Command (LCCC), save one—cost. The Longinus's sophisticated armor composites—near perfect copies of Clan battle-armor composites—required new manufacturing processes, a consideration that dramatically drove up the cost of manufacturing the

battle armor. The LCCC initially balked at the price, until the Captain-General himself authorized additional funding for the project.

## Longinus Armor Rules

The Longinus functions as standard Inner Sphere powered armor and follows the standard Inner Sphere battle-armor rules, with two exceptions. First, the suit may mount a single SRM-2 launcher, but may fire only a single missile salvo. Until the salvo is launched (and the launcher jettisoned), the unit may not use jumping movement or make anti-BattleMech leg or swarm attacks.

## ACHILEUS LIGHT BATTLE ARMOR

Concurrent with the design of the Longinus, development of the Achileus was handled by a joint League-Word of Blake research team. Using a suit developed by the Word of Blake as a model, the Achileus team designed the Achileus to serve as a mass-manufactured light battle-armor suit for deployment with both the FWLM and the Word of Blake Militia.

Unlike the Word of Blake's Tornado, the Achileus features armor-composite sheaths to contain and protect its layers of myomer musculature. The Achileus also features integral mounts for jump jets and a gyro-stabilized gun mount in the right arm.

Flamers, small lasers and machine guns are the most common weapons of choice, but the gun mount can accommodate a wide range of other anti-'Mech weapons as well.

Secondary armament consists of a single antipersonnel weapon, usually an SMG, mounted on the left arm just above the wrist. Rather than a claw, the suit's right arm ends in a fully functional manipulator hand,



slaved to the operator's own hand. Though the hand is too bulky to operate weaponry or most equipment, it can be used for lifting. Unlike the Longinus, the Achileus cannot carry an SRM launcher.

## Achileus Armor Rules

Every Achileus battle-armor suit has an Armor Value of 6 points, plus 1 additional point for the trooper inside.

The armor also provides excellent stealth abilities. This means that short-range attacks against Achileus units receive a +1 to-hit modifier, medium-range attacks receive a +4 to-hit modifier in place of the standard medium-range modifier, and long-range attacks take a +7 to-hit modifier in place of the standard long-range modifier. Additionally, Beagle active probes and their Clan equivalents cannot locate hidden Achileus units.

## INFILTRATOR STEALTH ARMOR

Among the earliest known prototype battle armor fielded in the Inner Sphere, the Federated Commonwealth's Infiltrator suit was based on captured Clan Elemental armor. Because they were unable to duplicate the mobility of the Clan suits, designers opted to equip the Infiltrator with an advanced stealth package to protect its wearers. This established the Infiltrator's role firmly as deep penetration. It is largely defenseless in an open-field fight.

## Infiltrator Armor Rules

Infiltrator units have 2 MP, cannot jump and are subject to all the standard movement restrictions regarding infantry and terrain. Infiltrator units cannot travel with an OmniMech using the Mechanized Battle Armor rules.

Each Infiltrator is armed with an auto grenade launcher. For game purposes, treat this weapon as a machine gun, except that each hit inflicts only 1 point of damage. Roll on the Battle Armor Attack Table per standard rules to determine the number of hits. Against unarmored infantry, each hit from the grenade launcher inflicts 1D6 damage.

Their physical construction and lack of jump jets make it impossible for Infiltrators to climb up onto a BattleMech, so they may not engage in anti-BattleMech leg or swarm attacks.

Infiltrators have an Armor Value of 5 points, plus 1 additional point that represents the trooper inside.

Infiltrator suits are specially constructed to baffle all types of sensors. This ability makes them very difficult to target at long ranges. Against Infiltrator units, increase the to-hit modifier for medium range to +3 and the to-hit modifier for long range to +6. In addition, Beagle active probes and their Clan equivalents cannot locate hidden Infiltrator units.

## SLOTH ASSAULT ARMOR

Immediately following the development of the Infiltrator, the Federated Commonwealth saw the need for a more heavily armed suit to supplement the Infiltrator units. An impressive weapon load, including two small lasers and a special anti-Mech mine launcher, were included on the new design. However, in order to support the additional weapons on the chassis while maintaining stability, the designers gave the Sloth an unusual four-legged configuration. This has raised some eyebrows among Commonwealth troopers, but the enhanced firepower of this armor is hard to ignore.

## Sloth Armor Rules

Sloth units have 3 MP, cannot jump and are subject to all the standard movement restrictions regarding infantry and terrain. Sloth units cannot travel with an OmniMech using the Mechanized Battle Armor rules.

Each Sloth comes equipped with two small lasers and a magnetic mine launcher. During the Weapon Attack Phase, a Sloth unit can either fire its lasers or launch one or more mines, but not both. After a successful attack with small lasers, roll on the Battle Armor Missiles Table to determine the number of hits inflicted on a target.

A Sloth unit that begins the Weapon Attack Phase in the same hex as a BattleMech or vehicle may choose to launch one or more magnetic mines instead of making a standard weapon attack. Unlike standard battle armor missile attacks, the controlling player can choose to fire mines with some or all of the Sloths in a unit, marking off the ammunition expenditure for each one fired on the record sheet. Each Sloth carries only one mine, so an undamaged squad of four Sloths can fire from one to four mines. If a Sloth is destroyed before it fires its mine, that mine is lost.

The base to-hit number for a magnetic mine attack is 8, modified for movement and terrain as normal. If the unit is making a pointblank shot from hiding (see *Hidden Units*, p. 77), do not modify the to-hit number for movement or terrain. If the attack hits, roll on the Battle Armor Attack Table to determine how many mines have become attached to the target, using the Point Members Active column that matches the number of mines fired by the Sloth unit. The mines hit the Center Torso if the target is a BattleMech, or the Front if the target is a vehicle. The attacker then rolls 2D6 for each mine that is attached and consults the Determining Critical Hits Table. If the result is 7 or less, the target takes 4 points of damage from the explosion. If the attack results in one or more critical hits, resolve those normally.

Their physical construction and lack of jump jets make it impossible for Sloths to climb up onto a BattleMech, so they may not engage in anti-BattleMech leg or swarm attacks.

Sloth suits have an Armor Value of 5 points plus 1 additional point that represents the trooper inside.

## SPECIAL CASE RULES

The *Special Case Rules* section offers detailed rules to resolve specific, strategically important situations that players may want to play out as part of their game. Players can use these rules to simulate the effects of artillery, minefields, fire, gun emplacements, hidden units and other tactical advantages.

All players should review the special-case rules and agree on those to be included in their game before beginning play.

### ANTI-BATTLEMECH INFANTRY

Infantry trained in anti-BattleMech tactics learn to close with a BattleMech, climb it and plant satchel charges in strategic, vulnerable locations. This dangerous tactic requires highly skilled and dedicated troops, but if successful, it can turn the tide of battle quickly.

Resolve anti-BattleMech attacks in the Weapon Attack Phase of the turn.

Note that anti-BattleMech-trained infantry platoons represent a rare sight on the battlefield. Thorough training in this specialized technique is time-consuming and expensive, so players should maintain a standard ratio of 1 anti-BattleMech platoon to 8 standard platoons.

#### LEG ATTACKS

Anti-BattleMech infantry units that begin a Weapon Attack Phase in the same hex as a BattleMech may choose to attack the BattleMech's legs instead of making a standard weapon attack. During leg attacks, infantry climb the BattleMech's legs and plant explosive charges in the joints to damage the actuators.

The base to-hit number is based on the number of troopers currently active in the unit. The more men, the greater the chance of success. Use the Leg Attacks Table to determine the base to-hit number. Modify the infantry unit's base to-hit number as normal for movement and terrain, and if the BattleMech is prone or immobile.

If the to-hit roll is successful, the attacker rolls 1D6. A result of 1-3 means the attack hit the left leg, and a result of 4-6 means the attack hit the right leg. If one leg has been destroyed, the attack automatically damages the other leg. The attacker then rolls 2D6 and consults the Determining Critical Hits Table. If the result is 7 or less, the leg takes 4 points of damage. If the attack results in one or more critical hits, resolve those normally.

**Hidden Units:** If the unit making a leg attack also uses the Pointblank Shots from Hidden Units rule (see *Hidden Units*, p. 77), do not modify the to-hit number for movement or terrain.

#### SWARM ATTACKS

Swarm attacks represent the boldest and most dangerous attacks that infantry can perform against a BattleMech. A unit making a swarm attack rushes a BattleMech, grapples and climbs it, and then inflicts damage against the MechWarrior or the upper parts of the BattleMech the next turn.

Anti-BattleMech infantry units that begin a Weapon Attack Phase in the same hex as a BattleMech may choose to swarm the BattleMech, rather than use their weapons or attack its

legs. Find the infantry unit's base to-hit number in the Swarm Attacks Table and modify it for movement and terrain, and by an additional -4 if the BattleMech is prone or immobile.

The swarm attack to-hit roll determines only if the infantry manages to gain secure footholds on the BattleMech. The infantry unit does not inflict damage on the BattleMech during either Combat Phase of this turn.

**Hidden Units:** If the unit making this attack also uses the Pointblank Shots from Hidden Units rule, do not modify the to-hit number for movement or terrain.

**Stacking:** Note that while an infantry unit is swarming a target, it still counts against the stacking limit of the hex.

#### Fighting Off Swarm Attacks

If the infantry successfully swarms a BattleMech, the BattleMech can try to remove the swarming unit by using its arms during the Physical Attack Phase of the turn, rather than making a physical attack. The BattleMech can make up to 2 Piloting Skill Rolls (one for each arm), adding a +4 modifier and any modifiers for damage or construction normally applied to a punching attack. A successful Piloting Skill Roll forces the infantry unit off the BattleMech and back into the hex, and the unit takes damage equal to a punch from that BattleMech. If the Piloting Skill Roll is unsuccessful, the BattleMech damages itself in the attempt to get rid of the infantry and must take punching damage from the appropriate arm (rather than falling from the failed Piloting Skill Roll). Roll 1D6 and consult the Front column of the BattleMech Punch Location Table to

LEG ATTACKS TABLE		
Troopers in Std. Platoon	Battle Armored Troopers Active	Base To-Hit Number
22-28	4-5	4
16-21	3	7
10-15	2	10
5-9	1	12
1-4	—	No attack possible

SWARM ATTACKS TABLE		
Troopers in Std. Platoon	Battle Armored Troopers Active	Base To-Hit Number
22-28	4-5	7
16-21	1-3	10
1-15	—	No attack possible

## SPECIAL CASE RULES

determine the location of the damage. If a BattleMech makes 2 attempts to remove the infantry, one may be successful and the other may fail. If the player declares that the 'Mech will make 2 attempts, both must be resolved, even if the first is successful.

During the Movement Phase of the following turn, infantry units that have not been knocked off travel with the BattleMech. Jump-capable BattleMechs may attempt to shake off their attackers during the Movement Phase. If the BattleMech jumps, the player makes a Piloting Skill Roll with a +4 modifier upon landing (in addition to any other Piloting Skill Rolls required by the jump). On a successful roll, the infantry unit falls off into the hex in which the BattleMech landed. The infantry unit cannot move or shoot for the rest of the turn, and takes one hit of 11 points of damage. If the Piloting Skill Roll made for shaking the infantry off fails, the 'Mech does not fall.

Attacks against the BattleMech being swarmed have no effect on the swarming infantry.

A swarming unit may end a swarming attack as its attack declaration during any subsequent Weapon Attack Phase. In this case, it is placed in the hex containing the target 'Mech with no further effects.

**Water:** If the BattleMech enters water of Depth 2 or deeper and the swarming infantry unit is a conventional infantry platoon (rather than a battle armor unit), the unit is destroyed. Any swarming infantry unit knocked off the target 'Mech in a Depth 1 or deeper Water hex is destroyed.

**Fire:** If the BattleMech ends its movement in a hex that is on fire, or if the BattleMech has been set on fire by an inferno missile (p. 131), and the swarming infantry unit is a conventional platoon (not a battle armor unit), the infantry fall off. The infantry unit's player rolls 2D6. On a result of 8 or more, the infantry are destroyed. If the infantry unit survives the fall into the burning hex, it cannot move or shoot for the rest of the turn. Battle armor troops are unaffected by fire so long as they are swarming.

**Falling/Dropping Prone:** If the BattleMech falls while it is being swarmed, the infantry unit falls off the BattleMech into that hex. The infantry unit cannot move or shoot for the rest of the turn and takes one hit of 11 points of damage. A BattleMech may intentionally go prone to shake off its assailants, but this requires a successful Piloting Skill Roll. If the BattleMech goes prone, it takes damage as from an accidental fall and must make an additional Piloting Skill Roll to avoid pilot damage as in an accidental fall. The infantry is knocked off as in an accidental fall.

### Swarm Attack Damage

If the infantry unit succeeds in staying on the BattleMech, it may make a normal weapon attack during the Weapon Attack Phase of the turn after it successfully swarmed the BattleMech. All attacks automatically hit. The player rolls 2D6 and consults the Swarm Hit Location Table to determine the location of the hit.

Damage from a swarm attack equals the unit's standard weapon damage. Battle armor units apply all damage to one hit location. For example, a full-strength battle armor Point equipped with small lasers will inflict 15 points of damage on

### SWARM HIT LOCATION TABLE

Die Roll (2D6)	Location
2	Head
3	Rear Center Torso
4	Rear Right Torso
5	Front Right Torso
6	Right Arm
7	Front Center Torso
8	Left Arm
9	Front Left Torso
10	Rear Left Torso
11	Rear Center Torso
12	Head

one location. A conventional infantry groups its weapon damage into 5-point clusters and applies it per the rules for LRMs.

By its nature, a swarm attack by an anti-BattleMech unit may also result in one or more critical hits. In addition

to determining normal damage, the player automatically rolls on the Determining Critical Hits Table, p. 35, even if no internal structure took damage in the attack.

Infantry units can continue to make weapon attacks on the BattleMech per the swarm attack rules in subsequent Weapon Attack Phases until the BattleMech is destroyed or manages to shake off the attacking unit, or the unit chooses to end the swarming attack.

## ARTILLERY

Artillery can provide a force with useful long-range fire support. Unlike the real world, where artillery is often the decisive force in combat, *BattleTech* artillery is only a supplement to conventional forces. BattleMechs are the kings of the battlefield, and even the best artillery strikes will rarely be more effective than a good 'Mech lance.

Players may decide to assign off-board indirect artillery to one or both sides during the game setup, either as dictated by the scenario being played or by mutual agreement of both players. When artillery is used, modify the normal sequence of play as follows:

Initiative Phase  
Targeting Phase  
Movement Phase  
Off-Board Attack Phase  
Weapon Attack Phase  
Physical Attack Phase  
Heat Phase  
End Phase

## GAME SETUP

Prior to placing their units on the mapsheet, players should determine the relative location of off-board artillery. Normally, off-board artillery sets up behind the area the onboard friendly forces will occupy. For example, if the friendly forces set up on the north side of the map, the off-board artillery sets up north of the map. Designating a specific location for artillery is important

## SPECIAL CASE RULES



# SPECIAL CASE RULES

## ARTILLERY MODIFIERS TABLE

Condition	Modifier
For every 2 points of Gunnery Skill less than 4 possessed by the spotting unit (fractions rounded down) (see <i>Artillery Spotters</i> below).	-1
For every 2 points of Gunnery Skill greater than 4 possessed by the spotting unit (fractions rounded down) (see <i>Artillery Spotters</i> ).	+1
Adjusting fire: for each previous shot fired at the target hex by the artillery unit(see <i>Artillery Spotters</i> ).	-1

because hit locations on BattleMechs and vehicles are determined by the direction from which the artillery fire arrives.

Players must also determine the artillery's distance from the map, expressed in units of 500 meters (the length of one *BattleTech* mapsheet). Keeping in mind the following considerations, players may place an off-board artillery piece any distance from the mapsheet up to its maximum range (see *Artillery Table*, p. 71). The farther away from the map an artillery piece is placed, the longer it takes for its shells to reach the target. The closer the piece is placed to the scene of the battle, the greater the likelihood that its position will be overrun and the weapon destroyed or captured if the battle goes against that side. If the players cannot decide on a range, position the artillery at a distance of half its maximum range from the battlefield.

Before beginning play, the player using artillery may secretly choose up to 5 hexes on the battlefield map as designated artillery targets. Artillery fire on a designated hex automatically hits.

### Definition of Off-Board

Any unit that is more than 17 hexes away from the target is considered off-board for purposes of artillery fire, even if the artillery unit is on the mapsheet and has a clear line of sight to the target hex.

If the attacker is 17 hexes or closer to the target, use the onboard rule (see *Onboard Artillery Fire*, p. 71).

### SHELL FLIGHT TABLE

Distance from Battlefield (in mapsheets)	Time in Flight (in turns)
Onboard	0
1-2	1
3-4	2
5-6	3
7-8	4
9-10	5
11-12	6
13-14	7
15-16	8
17-18	9
19-20	10

### TARGETING

During the Targeting Phase, a player with off-board artillery may select and record the map hex numbers that he wishes his artillery to fire on that turn. Off-board artillery fire can only be directed at hexes, not individual targets. Players may direct artillery fire at hexes not under the direct observation of a

friendly unit; however, this fire may not be adjusted (see *Artillery Spotters* below). Each artillery piece that a player controls may target a different hex. Record the turn in which each piece fired, each target hex, and the turn in which each fired shell will land. The turn in which a shell will land equals the current turn number plus the shell's time in flight, as shown on the Shell Flight Table.

### Artillery Spotters

If the target hex was in the LOS of a friendly unit (called a spotter) at the end of the Movement Phase of the turn in which the piece fired, and the same friendly unit has the target hex in its LOS in the turn in which the shell arrives, and the artillery piece has not fired at another target hex during the intervening turns, then the shot receives a modifier as shown on the Artillery Modifiers Table.

The player manning an artillery piece may attempt to adjust subsequent fire to home in on its target hex by noting how far off from the target hex and in which direction its shot landed. If there is a spotter with LOS to the target hex as described above, the attacker may adjust subsequent fire at that hex. Each shell that is adjusted in this way modifies the to-hit number for that artillery piece by -1, as shown in the Artillery Modifiers Table.

### Determining Hits

During the Off-Board Attack Phase, players announce artillery rounds due to land in that turn and resolve the effects of their fire.

Artillery fire may or may not land in the targeted hex. Except for fire against a designated artillery target hex, to determine whether or not an artillery attack hits its target hex, use a base to-hit Number of the firing unit's Gunnery Skill, and apply a standard modifier of +7, plus the appropriate modifiers from the Artillery Modifiers Table.

Roll 2D6. If the result equals or exceeds the modified to-hit number, the round hits the target hex; otherwise, the shot scatters. To determine where the scattered shot lands, roll two dice. The result of the first die determines the direction of the scatter per the Scatter Diagram above, and the result of the second die represents the distance away from the target hex (in hexes) that it lands.

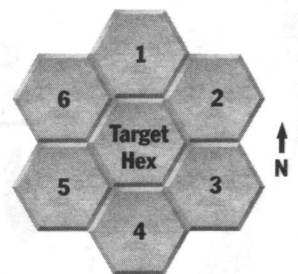

SCATTER DIAGRAM

## SPECIAL CASE RULES

Once an artillery unit hits its target hex, it will automatically hit that hex thereafter every time it targets that hex.

### DAMAGE

All units and structures occupying a hex hit by artillery fire take full damage from the attack. Group damage from artillery into 5-point clusters and apply to the target as for LRM damage.

To determine direction of attack for hit locations, consider the artillery piece to be in the center hex of the map edge beyond which it lies. Thus, if the artillery is located to the north of the mapsheet on which the battle is taking place, resolve hit locations as if the

attack originated in the center of the north edge of that mapsheet. See the Artillery Table for the Damage Values of each artillery type against the target and adjacent hexes. Determine damage to adjacent hexes as above, but use the Adjacent Hex Damage Value. The attack direction against targets in adjacent hexes is determined as though the attack came from the target hex.

**Buildings:** A building in a hex hit by artillery fire absorbs damage as normal before that damage affects any units inside (see *Buildings*, p. 51).

**VTOLs:** Artillery fire against their current hex does not affect units in flight (see *Artillery Flak*, p. 75).

**Water:** Underwater units take normal damage from any artillery shell that hits the hex they occupy.

**Death from Above:** A BattleMech executing a death from above attack is not affected by an artillery shell that hits the BattleMech's current or target hex.

### SMOKE ROUNDS

Off-board artillery units may fire smoke rounds instead of conventional rounds. A smoke round that hits a hex fills the target hex and adjacent hexes with smoke. A smoke-filled hex has the same effect as Heavy Woods on line of sight and to-hit modifiers. (See *Smoke*, p. 75). Under most circumstances, therefore, smoke does not affect BattleMechs.

Smoke from an artillery round dissipates in the End Phase of the third turn after it lands.

### ONBOARD ARTILLERY FIRE

While most players use artillery for off-board, indirect attacks, an artillery-equipped unit on the battlefield may be used for direct or indirect artillery fire.

#### Direct Fire

To fire a direct artillery attack, the artillery unit must have line of sight to the target hex, and the target hex must be no fur-

ther than 17 hexes away. Use a base to-hit number of the attacker's Gunnery Skill, with a standard modifier of +5. Do not modify the to-hit number for range, target movement, the terrain of the target hex, or an immobile target. The base to-hit number is modified normally for the attacker's movement and for firing through (not into) woods and for other terrain features.

A direct-fire artillery attack is made during the Weapon

Attack Phase and has no time in flight.

If the attack hits the target hex, the round inflicts standard artillery damage, including damage to adjacent hexes. If the round misses its target, it scatters as described in *Targeting*, p. 70.

ARTILLERY TABLE

Type	Maximum Range (in mapsheets)	Target Hex Damage	Adjacent Hex Damage
Arrow IV (IS)	5	20	10
Arrow IV (Clan)	6	20	10
Long Tom	20	20	10
Sniper	12	10	5
Thumper	14	5	2

#### Indirect Fire

Artillery pieces that start the game onboard may also fire indirectly per the off-board artillery fire rules if the target is more than 17 hexes away, or if there is no LOS to the target. In this case, the time in flight is determined by the number of mapsheets in distance (each 17 hexes or fraction thereof) from the firing unit to the target. Modify the to-hit number for attacker movement during the turn in which it fires.

### ARROW IV MISSILE ARTILLERY SYSTEM

Treat Arrow IV missile artillery as other artillery for game purposes, using all Artillery rules except as noted below.

The Arrow IV system may make two types of attack: a standard area-saturation attack or a homing missile attack against a target unit. The Clan version of the Arrow IV system can also deliver a FASCAM round, which lays a 30-point minefield in the target hex as described in *Thunder LRMs*, p. 132.

In a standard area-saturation missile attack, the weapon is fired in the same way as other artillery. Such attacks inflict 20 points of damage to all units in the impact hex and 10 points to all units adjacent to that hex. Determine scatter in the standard fashion.

#### Arrow IV Homing Missiles

Players firing homing missiles must select a specific TAG-equipped unit to act as spotter on the turn of the missile's arrival. If for any reason a friendly TAG-equipped unit cannot designate the target during the Off-Board Attack Phase of the turn in which the missile arrives on the board, the missile automatically misses and explodes harmlessly.

To use TAG equipment for target designation, the spotting unit must be within TAG range of the target and have line of sight during the Off-Board Attack Phase of the turn of arrival. The spotting unit cannot make any attacks of its own during the arrival turn. Calculate the to-hit number as for a standard weapon attack.

## SPECIAL CASE RULES

If the spotter fails to designate the target (the to-hit roll fails), the missile explodes harmlessly. If the spotter successfully designates the target (the to-hit roll is successful), the player firing the homing missile rolls 2D6 to see if the missile homes in successfully. On a result of 4 or greater, the missile hits its target. The missile does 20 points of damage to one location on the target and 5 points of artillery damage each to all other units in the hex.

If the spotting unit successfully designates the target but the missile misses, it still detonates in the hex and causes 5 points of artillery damage each to all units in the target hex, including the target unit.

Homing missiles do not attack adjacent hexes or scatter. Use the location of the spotting unit relative to the target to determine the direction of the attack. For example, if, relative to the target's facing, the spotting unit is on the left side of the target, use the Left Side column of the appropriate Hit Location Table to determine what part of the BattleMech or vehicle takes the hit.

One TAG-equipped unit can act as a spotter for any number of homing missiles with the same target arriving on the same turn. Only one roll to spot is required to designate the target. However, the player must make a separate to-hit roll for each missile to determine whether it successfully homed in on the signal.

The TAG system cannot target infantry.

**On-Board Arrow IV:** In the case of an on-board attack, the TAG unit must designate the target during the Weapon Attack Phase in which the homing missile is fired.

### BATTLEMECH LIFTING CAPABILITIES

In some situations, a BattleMech pilot may want his machine to lift and carry a piece of equipment. A BattleMech may not pick up a unit. Only BattleMechs with functioning hand actuators may pick up an object. To pick up an object, a BattleMech must end its Movement Phase in the same hex as the object, and it may make no weapon or physical attacks that turn. A BattleMech can pick up objects that weigh up to 10 percent of its tonnage. While the BattleMech is carrying the object, it cannot fire any arm or forward-firing torso-mounted weapons, make punching attacks, or use a club; it may make charging and kicking attacks and execute death from above attacks. In addition, the BattleMech suffers the limitations described in *Cargo Carriers*, below.

### CARGO CARRIERS

During construction of any vehicle, a player may dedicate specific tonnage to function as cargo space. This tonnage is considered enclosed and protected by the unit's armor. The unit may carry any cargo weighing up to this tonnage without penalty.

A BattleMech or vehicle may also carry unprotected cargo (in slings, strapped to the top, in lightweight containers, and so on) equal to its own tonnage. However, a unit carrying an external cargo weighing up to a quarter of its own weight must subtract 3 MP from its Walking/Cruising MP or half of its

Walking/Cruising MP (round down), whichever is less. A unit carrying a load weighing more than a quarter of its own tonnage may only move at half its Walking/Cruising MP (round down).

Any successful attack on a unit carrying unprotected cargo also strikes the cargo. If the cargo is infantry, the attacking weapon does 4 times its Damage Value. Determine hit location and damage against the carrying unit as normal; unprotected cargo does not reduce this damage. When the armor protecting cargo is destroyed, the cargo is destroyed at a rate of 1 ton per point of damage the unit takes.

The hauling unit may drop his cargo during his Movement Phase by expending 1 MP and declaring that he is dumping all his cargo. If the hauling unit is at ground level, the dropped cargo remains in the hex in which it was dropped. If the hauling unit is flying, the cargo takes normal falling damage from landing in the hex above which it was dropped.

### TERRAIN CONVERSION TABLE

Former Terrain	New Terrain
Heavy Woods	Light Woods
Light Woods	Rough
All others	No change

### CLEARING WOODS

Units can use heavy weapons fire to clear wooded hexes, though an attempt to do so may set the woods on fire by accident (see *Fire*, p. 74). Woods can be reduced from Heavy to Light, or cleared of trees completely, though the fallen trees convert the hex to Rough terrain rather than Clear. Though the BattleMechs and vehicles of the thirty-first century wield awesome firepower, even they cannot alter the terrain of a Rough or Clear hex.

When a player wants his BattleMech or vehicle to clear a wooded hex, he declares that hex as his unit's target during the Weapon Attack Phase. Modify the to-hit number as usual, including -4 for a stationary target. Do not modify the roll for firing into wooded terrain.

If the attack hits, the player determines the damage and then rolls 2D6. If the result is equal to or less than the damage inflicted by the attack, the Woods hex is converted to a different type of terrain, according to the Terrain Conversion Table. Otherwise, there is no effect (though the hex may still be accidentally set on fire). In the case of weapons that use the Missile Hits Table, roll on the table to determine how many missiles hit, but use the total damage of the attack, not the damage of individual SRMs or LRM clusters, when checking to see if the hex is converted.

**Infantry:** Infantry cannot clear woods.

### DROPPING TROOPS

Normally, troops enter a battlefield by advancing over ground to the target. In some cases, troops achieve the elements of speed and surprise through an assault drop. Such a

## SPECIAL CASE RULES

maneuver requires troops to drop from a DropShip while it is still in flight, either in space or atmosphere. Dropping troops wear special jump packs that allow them to descend to the planet's surface in relative safety.

The assault drop procedure is used in scenarios as an alternative method of landing troops on a *BattleTech* mapsheet. Note that only BattleMechs and battle armor-equipped infantry may make assault drops.

The player controlling the dropping troops should nominate a hex on the mapsheet in which each unit will land. For 'Mechs, the player makes a Piloting Skill Roll to determine whether the landing was successful. Modify the target number as usual for the unit's current damage. Because battle armor units have no Piloting Skill, simply roll 2D6 for each unit to determine whether the landing succeeded or failed. A result of 4 or better indicates a successful drop. A failed roll means the landing failed and the unit missed its target hex.

Dropped troops always land at the end of the Movement Phase. They may not fire or otherwise act for the remainder of that turn, but they may be fired upon (attacker modifies the to-hit number by +1 for target movement and adds the appropriate modifiers for range, terrain, and so on). Landed units function normally thereafter.

### FAILED LANDING DAMAGE

A BattleMech that fails its landing will take damage as though it had fallen a number of elevation levels equal to the number of points by which the roll failed (see *Falling*, p. 22 in *Movement*). For example, if a 'Mech with a modified Piloting Skill Target Number of 6 or higher rolled a 3, the unit would suffer damage as from a fall of 3 levels. A Piloting Skill Roll for landing that failed by more than 7 means the 'Mech is automatically destroyed.

If a battle armor unit rolls 3 on 2D6, it has failed its landing and each trooper in the unit suffers 1D6 damage. If the result is a 2, each trooper takes 2D6 damage.

### FAILED LANDING LOCATION

On a failed landing, the unit will also "scatter" 1D6 hexes for every point by which the result falls below the Piloting Skill target number. Use the Scatter Diagram for *Artillery*, p. 70, to determine the direction of the scatter. If the Piloting Skill Roll for landing fails by 5 or more, the unit misses the target mapsheet entirely and is considered destroyed for purposes of determining victory in the current scenario (use this rule only if playing an ongoing campaign).

### DUMPING AMMUNITION

During the course of a game, a player might wish to dump the ammunition carried by his BattleMech. He accomplishes this by opening the ammo loading doors on the back of the BattleMech and allowing the ammunition to fall out.

During the End Phase of a turn, a player can announce that his BattleMech will dump ammunition during the next turn. The unit may dump any or all of the ammunition it carries, but ammunition must be dumped by slot; if any ammo in a slot is

dumped, all of the ammo in that slot must be dumped. Dumping is carried out during the course of the following turn.

When a player announces that his unit will be dumping ammunition, that ammunition is no longer available for use. However, the ammunition is not actually gone from the BattleMech until the End Phase of the following turn. For that one turn, the ammunition remains onboard in its normal location and critical slot, and is subject to the effects of heat buildup and critical hits.

A BattleMech that is dumping ammunition cannot run or jump in that turn. Any hit against the dumping 'Mech on any rear torso location during the Weapon Attack or Physical Attack Phases inflicts normal damage, but it also causes all dumping ammunition that can explode to do so. (Ammunition can be stored in many different BattleMech locations, but it is loaded and unloaded through the rear torso.)

Ammunition dumped into a hex cannot be exploded or used for any type of attack.

### EJECTION MODIFIERS TABLE

Landing Terrain	Modifier
Clear	-2
Water	-1
Rough	0
Rubble	0
Light Woods	+2
Heavy Woods	+3
Per Level of Building	+1
<b>Situation</b>	
BattleMech Prone	+5
Pilot Unconscious	+3
Per Point of Head Internal Structure Damage	+1
Automatic Ejection	+1

### EJECTING

Under certain unfortunate conditions, a MechWarrior may be forced to leave his BattleMech in a hurry, best accomplished by using the cockpit ejection system. When the pilot fires this system, explosive bolts allow the cockpit canopy to separate from the 'Mech and the pilot rockets away from the now-disabled BattleMech. The ejecting MechWarrior usually lands in the hex immediately behind the abandoned BattleMech. All BattleMechs are equipped with sensors that detect impending ammo explosions and automatically eject the pilot before the ammo explodes. Because the advent of CASE (described in *Equipment*, p. 126) made it more likely for a BattleMech to survive an ammo explosion, many MechWarriors disable the auto-eject feature. Players must decide before each battle and note on the record sheet whether or not the pilot disables his 'Mech's auto eject.

## SPECIAL CASE RULES

During the Movement Phase, a player may choose to have the MechWarrior eject rather than move. If the auto-eject function is operational, the pilot can also eject at the end of any Attack Phase in which an ammo explosion takes place.

Ejecting from a 'Mech can be dangerous, and the pilot may suffer damage upon landing. The pilot must make a successful Piloting Skill Roll to avoid taking damage, modified for the circumstances listed on the Ejection Modifiers Table.

A pilot who fails this Piloting Skill Roll takes 1 point of damage and will need to make a Consciousness Roll.

A conscious pilot who successfully ejects may move at the rate of 1 MP per turn in the same manner as a standard infantry unit. He may be fired on in the same manner as an infantry unit, but with an additional +2 to-hit modifier. If the pilot ends a Movement Phase in the same hex as any unit (friendly or enemy), the pilot is considered to have been picked up in the End Phase; he may choose by which unit if more than one occupies the hex. Pilots picked up by friendly units that survive the battle or move off the board have survived and can be used again in future games. Players may ransom pilots captured by enemy forces if they wish.

### FIRE

Many battles are decided not by the skill or abilities of the soldiers involved, but by the spread of fire across the battlefield. Players may use the following rules to simulate the effects of fire.

Place a Fire counter on any hex that is set on fire during the game. Use one produced by FASA, or create your own. Once started, a fire will continue to burn for the rest of the game, or until there is nothing left in the hex to burn (such as a burning Woods hex being cleared to rough terrain, or when a burning building is reduced to rubble).

**Buildings:** For each turn that a building is on fire, it loses 2 CF. If a BattleMech moves through a burning building, it suffers normal heat buildup from fire as well as all other normal damage.

### ACCIDENTAL FIRES

Weapons powerful enough to smash a BattleMech with one blow may also create extensive collateral damage, the most devastating of which is fire. Players may use the following rules to represent accidental fires.

A unit attempting to clear a wooded hex (see *Clearing Woods*, p. 72) runs the risk of setting the woods on fire accidentally. To represent this risk, the player rolls 2D6 before each clearing attempt. On a result of 5 or less, the woods have been accidentally set alight rather than cleared.

If a weapon attack against a unit occupying a wooded hex misses its target, and the weapon can be used to start fires (see *Intentional Fires*, below), the attacking player rolls 2D6 to determine whether his attack accidentally set a fire. On a result of 2 or 3, the hex catches fire. A building cannot be accidentally set on fire.

### INTENTIONAL FIRES

BattleMechs carry many weapons capable of starting fires in wooded hexes. Once started, fires spread easily from hex to hex, producing heat buildup in BattleMechs moving through or standing in those hexes. Different weapons offer different chances of starting a fire.

Players who intend to start fires may declare that their unit will fire its weapons at any Woods or Building hex. Standard infantry weapons, with the exception of flamers, cannot be used to start a fire. Modify the base to-hit number by -4 for an immobile target for this attack, as well as for the attacker's

normal movement and other appropriate modifiers. On a successful attack, the player rolls 2D6 and consults the Fire Table to determine if the attack started a fire. If the attack starts a fire, place a Fire counter on the target hex. Multiple successful attempts to start a fire do not make the fire larger.

*A BattleMech fires two PPCs at a Medium Building in an attempt to set it on fire. Both attacks hit. Energy weapons normally start fires on a die roll result of 7 or higher, but the player must modify this to-hit number by +1 because the target is a Medium Building, for a Target Number of 8. The player rolls a 9 and a 10. Because the first attempt succeeded, the second has no further effect, but the building is on fire.*

### EFFECTS OF FIRE

During the Heat Phase, a BattleMech occupying a burning hex absorbs an additional 5 Heat Points. A BattleMech also absorbs 2 Heat Points for each burning hex that it moved out of

### FIRE TABLE

#### Starting Fires

Weapon Type	Success Number
Flamer	4+
Incendiary LRMs	5+
Energy Weapon <sup>1</sup>	7+
Missile or Ballistic <sup>2</sup>	9+
Inferno	Automatic
<b>Modifiers</b>	
Woods	0
Light Building	0
Medium Building	+1
Heavy Building	+2
Hardened Building	+3
Other terrain	Fire cannot start or spread

#### Spreading Fires

Hex is downwind	9+
Hex is 60° from downwind	11+
Crossing nonburning hex	+3

<sup>1</sup> May not use small laser or ER small laser, or any kind of micro laser.

<sup>2</sup> May not use Gauss rifle, SRM-2 or standard SRM infantry.

## SPECIAL CASE RULES

during the Movement Phase. A unit occupying a hex ignited during the Attack Phase of the turn will not be affected by the fire until the Heat Phase of the following turn.

**Non-Mech Units:** Unless the controlling player rolls an 8 or higher on 2D6, any non-BattleMech unit that ends its Movement Phase on the ground in a burning hex or moves along the ground into a burning hex is destroyed. The player must make this roll each time a unit meets either condition.

### SPREADING FIRES

Fires on the battlefield can spread from hex to hex in the direction of the wind through Woods and Building hexes, but they cannot spread into other terrain.

### Determining Wind Direction

At the beginning of the game, declare one side of a hex on the mapsheet to be Direction 1, numbering the remaining hexsides as 2 through 6, moving clockwise. Roll 1D6. For the entire game, the wind will blow in the direction indicated by the die roll result.

### Determining Spread

During the End Phase of every turn, check to see if any fires currently on the map spread to additional hexes. Roll 2D6 for the adjacent hex directly downwind of a Fire hex. If the result is equal to or greater than 9, and if that hex can burn (see the Fire Table), the fire spreads into the hex. Also roll 2D6 for each of the two hexes adjacent to the burning hex at 60

degrees from downwind (the remaining two hexes in the fire's "forward arc"). If the result is equal to or greater than 11, and if the hex can burn, the fire will spread into that hex as well.

A flammable hex directly downwind from a fire but separated from the fire by a nonburning hex may also catch on fire. Roll 2D6. On a result of 12, the fire spreads to a flammable hex directly downwind from a fire.

If one hex may catch fire because of its relationship to several burning hexes, roll for each possibility.

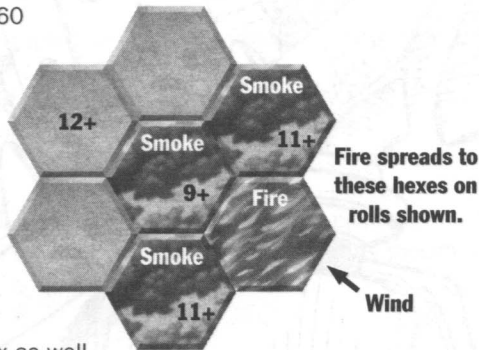

### SMOKE

A fire spreads smoke to the adjacent hex downwind and to the 2 adjacent hexes 60 degrees from downwind (i.e., the 3 adjacent hexes of the fire's "forward arc"). It does not create smoke in its own hex (though a fire upwind from it may do so). Treat a smoke-filled hex as though it were Heavy Woods for purposes of line of sight and to-hit modifiers. Smoke rises two levels above the terrain it occupies.

## FLAK

Players can use onboard artillery and LB-X-class autocannons to make effective attacks against VTOLs.

### ARTILLERY FLAK

Units can use an onboard artillery weapon (Arrow IV with nonhoming missiles, Long Tom, Sniper, or Thumper) to fire directly at an airborne VTOL. The player must declare that he is firing at the VTOL, and must have a valid line of sight to the target unit. Resolve the attack as normal for an artillery direct-fire attack, per the rules in *Onboard Artillery Fire*, p. 71, except do not modify the to-hit number for target movement. The Base To-Hit Number is 9, modified only by the firing unit's movement and current damage. Determine damage to flying units in the target and adjacent hexes as normal.

Direct artillery attacks against airborne units do not affect nonflying units in the target and adjacent hexes. VTOLs flying at a different altitude from the target VTOL are also unaffected. Shots that missed scatter as normal but explode at the elevation of the target unit.

### LB-X CLUSTER FLAK

LB-X autocannons firing cluster ammunition prove very effective against VTOLs in flight. For any attacks using cluster ammunition against a flying VTOL, subtract 3 from the base to-hit number rather than the usual -1 (for cluster munitions). Treat all other aspects of the attack as a normal weapon attack.

## FOUR-LEGGED BATTLEMECHS

The four-legged 'Mechs available in *BattleTech* normally use the same rules as bipedal BattleMechs. Players who wish to give quadrupedal BattleMechs (known as quads) a unique role in their games may use the following rules. Unless otherwise noted, use the rules for two-legged BattleMechs.

### CONSTRUCTION

Replace the right and left arm locations with an additional set of legs when constructing a quad 'Mech. These additional legs have the same number of internal structure boxes as standard legs, so they can mount additional armor. This second set of legs offers less room to mount weapons and other equipment than do arms—as shown on the Critical Space Table, p. 109. Quad Mech's have fewer critical hit slots than two-legged 'Mechs.

### MOVEMENT

Their unique configuration gives quad 'Mechs certain movement advantages over bipedal BattleMechs, mainly the ability to make lateral shifts and improved Piloting Skill target numbers.

#### Lateral Shift

Quads may perform a special movement action that allows them to move laterally, or sideways, without changing their facings. A quad making a lateral shift moves into any adjacent hex that is not directly to its front or rear, while retaining its original facing.

# SPECIAL CASE RULES



© 1985 TSR

## SPECIAL CASE RULES

A lateral shift costs 1 Movement Point in addition to the cost of moving into the target hex. Note that a two-legged BattleMech can effectively perform the same action using facing changes for 1 more MP.

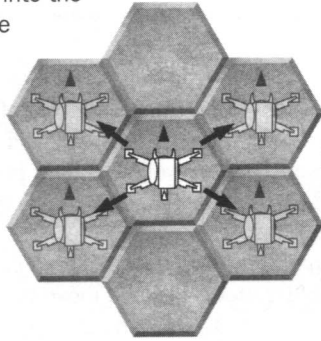

**Possible Lateral Shifts  
(1 additional MP to  
enter hex)**

### Piloting Skill Rolls

The inherent stability of four-legged BattleMechs allows them to move easily to avoid a fall. As long as none of the quad's legs are destroyed, add a -2 modifier to all Piloting Skill Rolls made to avoid falls. For example, a *Tarantula* piloted by a MechWarrior with a Piloting Skill of 5 would need only a 3 (5 - 2) or greater to remain standing when entering a Depth 2 Water hex. After a successful charge, this quad would remain standing on a roll of 5 (5 + 2 - 2) or greater.

After they fall down or drop to the ground, four-legged 'Mechs find it very easy to stand up again. No Piloting Skill Roll is necessary for a fallen quad to stand (unless one or more legs have been destroyed; see *Leg Damage* below), though the usual MP cost and heat generation apply.

### COMBAT

Use the following rules for four-legged BattleMech combat.

#### Torso Twist/Turret Rotation

Quad 'Mechs cannot torso twist.

#### Firing When Down

Due to its physical arrangement, a prone quad need not prop itself up to fire, so it makes attacks while prone as though it were standing.

#### Physical Attacks

Because they have no arms, quads cannot make punching, pushing, or clubbing attacks. They may make a single kicking attack with one of their forward legs as long as they have suffered no hip critical hits. They may make charging attacks normally and, in the case of jump-capable quads, execute death from above attacks in the normal manner.

#### Hit Location Table

Apply all damage that hits the right or left arm to the right or left forward leg, respectively. Apply all damage that hits the right or left leg to the right or left rear leg, respectively.

#### Leg Damage

Consider all critical hit damage to be cumulative. Each hip critical hit reduces the quad's Walking MP by half. Thus, three destroyed hips cut the quad's Walking MP to an eighth of its

normal rate, and the pilot must modify the Piloting Skill target by +4 (+6 for three destroyed hips, but -2 for four intact legs).

A single destroyed leg immediately causes a quad to fall and negates all the movement and combat bonuses gained from being a quad: the 'Mech can no longer lateral shift; it loses the -2 modifier to Piloting Skill Rolls; it must make a successful Piloting Skill Roll to stand after falling; it must prop itself up with one of its forward legs to fire while prone, and suffers a +2 modifier to firing while prone. In addition, any penalties associated with damaged leg actuators in the destroyed leg are now disregarded, instead replaced with a -1 MP penalty.

After losing two legs, a quad functions with the same restrictions as a two-legged 'Mech that has lost one leg: it immediately falls; it has only 1 MP; Piloting Skill Rolls are modified by +5; and so on.

After losing three or four of its legs, a quad cannot move at all. It automatically falls and has 0 MP available. It cannot prop itself up to fire.

### HEAT

All four legs of a quadrupedal BattleMech can be submerged in Level 1 water. This allows all heat sinks in the legs to operate at double efficiency up to the maximum shown on the Heat Point Table, p. 47.

### HIDDEN UNITS

At the start of a game, each side may secretly hide on the map a number of units determined by the scenario being played, or agreed to by all players. Players must write down the number of each hex in which a unit is hidden and designate the unit's facing.

Hidden units will remain hidden until they attack or move, or until an enemy unit moves into their hex, attempts to move into their hex, or ends its movement adjacent to their hex.

Unless the player plans to move a hidden unit during the Movement Phase, hidden units are not counted for purposes of determining movement order during the Movement Phase. If the player plans to move a hidden unit during a turn, he must reveal that unit and place it on the map at the start of the Movement Phase of that turn. If a player plans to attack using a hidden unit, he must reveal that unit and place it on the map at the beginning of the Weapon Attack Phase. Hidden units revealed during the Movement Phase cannot move during that phase.

If a unit attempts to enter a hex containing a hidden unit, and if by doing so it would violate the stacking rules (see *Stacking*, p. 20), the unit immediately ends its movement, and the hidden unit is revealed.

**BattleMechs:** BattleMechs cannot be hidden in Clear or Paved hexes.

### POINTBLANK SHOTS FROM HIDDEN UNITS

When an enemy unit moves into or ends its movement adjacent to a hex occupied by a hidden unit, the hidden unit may immediately make a pointblank weapon attack. The unit may only fire weapons with a valid firing arc to the target, using a

## SPECIAL CASE RULES

Range of 1. However, the hidden unit may immediately torso twist or rotate its turret in order to bring its weapons to bear against the target. Do not modify the base to-hit number for movement or terrain. Any damage takes effect immediately during the Movement Phase, and the results may affect the actions of the target unit for the rest of the phase. A unit attacking with a pointblank shot may not move, fire again, make physical attacks, or perform any other action during that turn.

### HOSTILE ENVIRONMENTS

Players may use the following rules to simulate combat in extreme temperatures, low gravity, difficult terrain, or even vacuum.

#### EXTREME TEMPERATURES

For combat in temperatures between -30 and 50 degrees Celsius (-22 degrees and 122 degrees Fahrenheit), the environmental conditions have no impact on a game of *BattleTech*. However, fighting in significantly higher or lower temperatures affects how well BattleMechs dissipate heat and degrades the combat effectiveness of other units.

For BattleMechs, for each 10 degrees C (or fraction thereof) higher than 50 degrees, add 1 Heat Point to the unit's overall heat buildup each turn. For every 10 degrees C (or fraction thereof) less than -30 degrees, subtract 1 Heat Point from the BattleMech's overall heat build-up each turn.

**Vehicles:** For vehicles, for each 10 degrees C (or fraction thereof) higher than 50 degrees, reduce their cruising speed by 1 Movement Point. For every 10 degrees C (or fraction thereof) less than -30 degrees, reduce their cruising speed by 1 Movement Point. Recalculate flank speed based on the new cruising speed.

**Infantry:** Unarmored infantry platoons cannot be deployed outside a vehicle or building in temperatures that exceed 50 degrees C or are less than -30 degrees C. Extreme temperatures affect infantry in battle armor in the same way as vehicles, slowing their movement.

#### ICE

Extreme cold (0 degrees C or less) can cause a body of water to freeze. This may allow units to cross a Water hex more easily, though they run the risk that the ice will break and the units fall through. In addition, normal terrain can become coated with ice, making all movement treacherous.

Prior to the start of the game, players should indicate which hexes are ice-coated. Water hexes must be designated as either ice-covered or frozen solid.

BattleMechs and ground vehicles that make a facing change and then move on an ice-coated hex must check to see if they skid (see *Skidding*, p. 21 in *Movement*), even if they are moving at walking or cruising speed.

Any BattleMech or ground vehicle that enters an ice-covered Water hex may break through the ice and fall into the water below if the hex is not frozen solid. VTOLs can only break through the ice if they are crashing or landing on the ice. Roll 1D6. On a result of 6, the ice breaks and the unit falls into the

water. BattleMechs take one-half normal falling damage (for falling in water). Vehicles are destroyed (but hovercraft are unaffected). The Water hex remains unfrozen for the remainder of the game.

Note that the tonnage of the unit is not a factor in a unit breaking through the ice—it is, rather, a factor of ground pressure, not overall weight. Larger BattleMechs and vehicles have larger "footprints," so the weight of their presence on the ice exerts pressure per square meter as low as that of lighter units with smaller footprints.

After falling through the ice, a BattleMech can climb out of a Depth 1 or Depth 2 Water hex and move back onto the ice. A BattleMech in Depth 3+ water must travel under the ice, following the underlying terrain, until it reaches a Depth 2 hex, at which point it can break through the ice (see *Underwater Operations*, p. 88), or until it reaches a Depth 1 hex, at which time it automatically breaks through the ice, converting the hex to open water.

**Converting Terrain:** An ice-covered Water hex can be converted into a normal Water hex by melting the ice with weapons fire, using the *Clearing Woods* rules, p. 72. Units (except hovercraft) occupying a hex converted in this way fall into the water. Infantry units and ground vehicles that fall into the water are destroyed.

**Jumping:** For jumping BattleMechs that land on an ice-covered Water hex, roll 1D6. On a result of 4+, they break the ice and fall through.

#### HIGH/LOW GRAVITY

Combat on worlds whose gravity is significantly greater or less than normal Earth gravity (1 G) affects a unit's movement. As shown in the following rules, while low gravity generally allows units to move faster, it does not reduce their mass and momentum, and so offers a chance that the unit will suffer damage through normal movement. For example, a BattleMech traveling 200 kph on a .5 G world is likely to snap off its legs.

Gravity affects all units' movement in the same way. To determine a unit's movement rates as affected by gravity, divide its Walking (or Cruising) and Jumping MP by the G-rating of the world and round to the nearest whole number (round down at .5). Calculate the new Running (or Flank) MP based on the revised Walking (or Cruising) MP. Thus, a unit with a normal Walking MP of 4 would have Walking MP of 5 on a .75G world ( $4 \div .75 = 5.3$ , rounded to 5). On a 1.25-G world, that same unit would have a Walking rate of 3 ( $4 \div 1.25 = 3.2$ , rounded to 3). Units whose MP is reduced to 0 by the effects of gravity are incapable of moving.

BattleMech legs and vehicle suspensions are designed to operate at maximum efficiency on worlds with close to 1 G gravity. If the gravity of a world allows the unit to move faster than normal, the strain on the unit's systems may damage its internal structure. If a unit spends more MP than its normal Running (or Flank) MP during a turn (as in the example above of the unit moving on a world with .75 G), the player must make a Piloting Skill Roll at the end of the phase in which the Running MP was exceeded, appropriately modified for relevant condi-

## SPECIAL CASE RULES

tions, to determine if the unit takes any damage from moving at an unusual rate. If the Piloting Skill Roll fails, the unit takes the following damage: a BattleMech takes 1 point of internal structure damage to each of its legs for every point of movement by which the unit exceeded its normal Running MP (the BattleMech does not fall if this roll fails). Thus, a BattleMech with a normal Running MP of 8 that spends 10 MP running during a turn and then fails a Piloting Skill Roll would take 2 points of internal structure damage to each of its legs. A vehicle takes 1 point of damage to its Front side internal structure for each Movement Point spent that exceeds its normal Flank Speed MP.

Roll on the Determining Critical Hits Table to resolve whether internal structure damage resulted in a critical hit. Apply critical hit results before the Weapon Attack Phase of the turn.

**Jumping:** A BattleMech that jumps in any gravity other than 1 G takes damage under the same conditions. Make a Piloting Skill Roll, adding the appropriate modifiers. If the roll fails, the BattleMech takes 1 point of internal structure damage to each leg for each Movement Point spent jumping that exceeds its normal Jumping MP.

**Falling:** Calculate damage from falls taken in unusual gravity normally, then multiply the result by the G-rating of the world and apply the total damage to the unit.

### SWAMP

Depth 0 Water hexes normally represent swampy ground. Though standard *BattleTech* rules treat this terrain essentially as a Clear hex, players can use the following rules to more realistically represent the effects of swampy terrain.

Before beginning play, designate all Depth 0 Water hexes as some other type of terrain, and choose any number of Clear, Rough, or Woods hexes to be swampy. The hex's original terrain type still restricts certain units. For example, wheeled vehicles cannot enter swampy Rough or wooded hexes. Use the swampy terrain's original terrain for determining LOS. Swampy terrain does, however, impede movement by increasing the MP cost for the terrain and might trap unlucky units.

Increase the movement cost to enter any swampy hex by 1 MP. Thus, entering a swampy Clear hex costs 2 MP (rather than 1 MP) and entering a swampy Light Woods hex costs 3 MP. This increased MP cost applies to all units, including infantry, but not hovercraft.

When a BattleMech or ground vehicle enters a swampy hex, the player must make a Piloting Skill Roll. If the roll fails, the unit becomes stuck in the hex and may not move for the rest of the turn (a BattleMech that fails this roll does not fall). The unit may torso twist or rotate its turret normally, but it may not change its facing. For any weapon or physical attacks made against a unit stuck in a swampy hex, modify the to-hit number by -2.

At the start of the next turn's Movement Phase, the player controlling a stuck unit makes a Piloting Skill Roll. On a successful roll, the unit breaks away from the swampy terrain and may move normally. If the roll fails, the unit remains stuck (but does not fall) and makes another Piloting Skill Roll at the start of the next Movement Phase.

**Infantry:** For infantry entering a swampy hex, roll 2D6. On a result of 4 or less, the unit becomes stuck. To escape being stuck, an infantry unit need only roll 5+ on 2D6.

**Jumping:** A jumping BattleMech that lands in a swampy hex automatically becomes stuck, though jumping infantry units do not.

### VACUUM

All BattleMechs are capable of operating in a vacuum, though combat on an airless world poses many dangers. Exposing the inner workings of a BattleMech to a vacuum will freeze actuators and make weapon components fail.

**Vehicles:** Only fusion-powered vehicles can function in a vacuum. To operate in a vacuum, 10 percent of a fusion-powered ground vehicle's tonnage must be devoted to sealing the vehicle and providing life support for the crew. Hovercraft, naval vessels and VTOLs cannot operate in a vacuum.

### Hull Integrity

Whenever a BattleMech or vehicle operating in a vacuum takes a hit that inflicts damage, the controlling player rolls 2D6. On a result of 10 or greater, the unit's hull has been breached. The integrity of that location has been lost and all components in that location exposed to vacuum. If all of a location's armor is destroyed, that location is automatically breached.

Treat all of a BattleMech's components in a breached location as nonfunctional. None of that location's actuators, weapons, or other equipment works; if the breached location contains engine slots, the engine now functions as if it took as many critical hits as there were engine critical slots in that location.

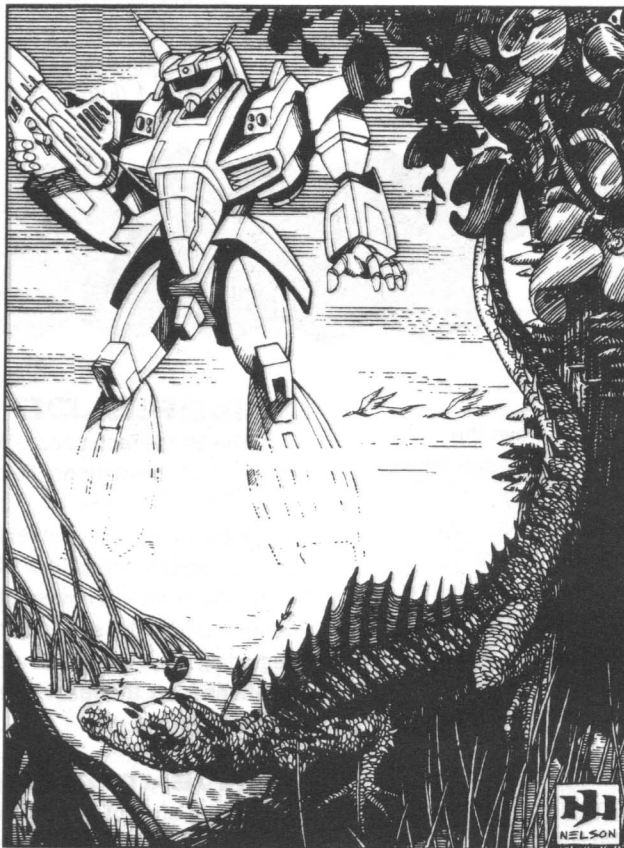

## SPECIAL CASE RULES

Note that these hits are not technically critical hits and, for example, will not cause ammunition to explode. Equipment and components in the breached location can still take critical hits per the standard rules, even though the component is temporarily nonfunctional.

Breached locations continue to take damage as usual. Do not transfer combat damage inflicted on a breached location until that location's internal structure is destroyed.

**Vehicles:** If any location on a vehicle is breached in a vacuum, the vehicle is destroyed.

### Infantry

Infantry units equipped with space suits and properly modified battle armor units can function normally in a vacuum. However, double any damage taken by an infantry unit while operating in a vacuum to represent the loss of personnel due to suit breaches, damage that normally would not result in any casualties.

### IMPROVED POSITIONS

Given enough time, a defending unit can improve the natural defenses of the surrounding terrain. If both sides agree to use the improved positions rule, units that start on the mapsheet may begin the game in improved positions. Treat these field fortifications as a Light Building with a CF of 15. These positions do not affect line of sight or movement in any manner, and a unit cannot climb on top of an improved position to increase its elevation level. Apply standard terrain modifiers to any unit in an improved position. Units that begin the game in improved positions may also use the *Hidden Units* rule, p. 77.

### LRM INDIRECT FIRE

Units armed with LRM-type weapons may fire those missiles indirectly. Indirect fire allows a unit that does not have a direct line of sight to a target to attack that target, though some friendly unit must have a valid line of sight to the target (this unit is referred to as the *spotter*). Resolve LRM indirect fire attacks in the turn they are launched (rather than allowing flight time as for artillery).

The base to-hit number is the Gunnery Skill of the firing unit. Use the following modifiers:

- Range modifier based on the range between the target and the firing unit, including minimum range modifiers,
- +1 for indirect fire,
- All standard modifiers for target movement,
- All standard modifiers for attacker movement, and a modifier for the spotter's movement,
- Terrain modifiers based on line of sight from the spotting unit.

The spotting unit cannot make any attacks in the turn that it spots for another unit.

*A Atlas has walked into Hex A, which lies behind a Level 4 hill. On the other side of the hill, in the light woods of Hex B, stands a Clan Dragonfly. Normally, the*

*Atlas could not attack this target because it does not have a valid line of sight to the Clan 'Mech. However, a friendly Savannah Master, which cruised this turn, is in Hex C with a valid line of sight to the Dragonfly through a hex of light woods.*

*The Atlas may fire its LRMs indirectly at the Dragonfly using the Savannah Master as a spotter.*

*The modified To-Hit Number is 4 (Gunnery Skill) + 2 (medium range) + 1 (indirect fire) + 1 (Atlas movement) + 1 (Savannah Master movement) + 1 (through light woods) + 1 (into light woods), for a total of 11.*

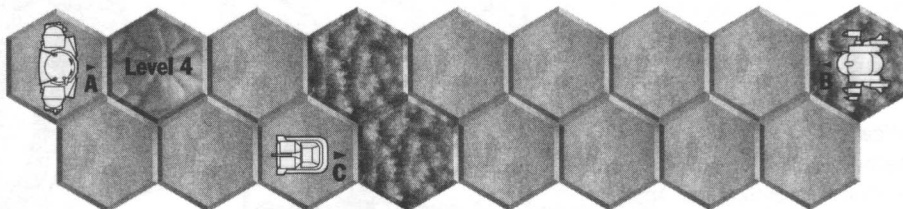

### MINEFIELDS

The *BattleTech* rules offer the use of three forms of minefields: conventional fields, command-detonated fields and vibrabomb fields.

Players assign minefields to hexes during the initial game setup, secretly noting in writing the type and location of each field. The number of minefields available to each player may be determined by the scenario or agreed to by all players before beginning play. Though some scenarios may designate minefield locations, only the referee or controlling player should know those locations.

#### CONVENTIONAL MINEFIELDS

At the start of play, the defending player receives a number of unspecified hexes that he can designate as conventional minefields. Whenever any ground unit (BattleMech, ground vehicle, or infantry, friend or foe) enters one or more of these designated hexes, the minefield automatically attacks the unit. The player controlling the mines rolls 2D6. On a result of 7 or more, the unit has hit a mine. Resolve the attack and apply the damage before the unit continues its movement. The defending player may make this roll secretly, so that if the minefield does not explode, its location remains hidden.

Conventional minefields that explode inflict 6 points of damage to the Front side of the unit entering the hex. To determine damage to BattleMechs entering a minefield, use the BattleMech Kick Location Table. A conventional minefield remains active and can make any number of attacks throughout the game, unless cleared (see *Clearing Minefields*, below).

#### COMMAND-DETONATED MINEFIELDS

At the start of play, the defending player receives a number of unspecified hexes that he can mine with command-detonated explosives. At any time during the turn sequence that a defending unit has line of sight to the mined hex, he may detonate any or all of these mines.

## SPECIAL CASE RULES

Detonating the explosives does 10 points of damage to each unit occupying the hex and 4 points of damage to each unit in each adjacent hex. Buildings will absorb damage until reduced to rubble, then the remainder of the damage affects units in the building. This applies to buildings in the target or an adjacent hex.

Apply damage from command-detonated mines to the Front side of the unit. To determine damage to BattleMechs entering a minefield, use the BattleMech Kick Location Table. Resolve the attack and apply the damage as soon as the explosion occurs.

A command-detonated hex may only be exploded once during a game.

### VIBRABOMB MINEFIELDS

At the start of play, the defending player receives a number of unspecified hexes that he can plant with vibrabombs. Treat a vibrabomb like a conventional mine, with the following exceptions. Vibrabombs can only be set off by the unique vibrations created by an approaching BattleMech. Vehicles and infantry cannot trigger vibrabombs. Any BattleMech can set off a vibrabomb, and vibrabombs go off automatically.

Vibrabombs have a variable sensitivity, and when placed must be set to respond to a specific mass. BattleMechs massing 10 or more tons lighter than the vibrabomb setting will not set off the minefield. A BattleMech massing more than 10 tons heavier than the setting will set off the mine at a distance of 1 hex for each 10 full tons by which it is heavier than the bomb's setting.

For example, if the bomb is set to respond to a 40-ton 'Mech, and a 75-ton *Orion* enters a hex 3 hexes away, the bomb explodes. A 30-ton *Javelin* walking directly through the hex containing the bomb would not set it off.

A unit occupying the same hex as an exploding vibrabomb takes 10 points of damage to its Front side. Exploding vibrabombs do not affect adjacent hexes. Use the BattleMech Kick Location Table to determine damage to a BattleMech.

A vibrabomb only explodes once during a game.

### CLEARING MINEFIELDS

Clearing minefields is a dangerous job requiring great skill and finesse, so it is usually assigned to infantry. If an enemy infantry unit ends its turn in a mined hex, the opposing player must be informed that his unit has entered a mined hex, even if the field has not been detonated.

Infantry that spend 1 Movement Phase in a mined hex without moving may elect to clear the field instead of attacking during the Weapon and Physical Attack phases. If the infantry unit rolls 2D6 with a result of 10 or higher in the Weapon Attack Phase, they have successfully cleared the field. A die roll result of 5 or less means that the minefield exploded; the infantry takes normal damage. Conventional fields remain active after an accidental detonation, but accidental detonation clears vibrabomb and command-detonated minefields. If multiple infantry units are attempting to clear the same hex, all units must make a successful roll to clear the minefield. If any unit

rolls a 5 or less, all units attempting to clear the hex take damage.

**Artillery:** A player may use artillery fire to clear a minefield. The player must designate the fire mission to clear the minefield. When the fire mission hits the hex, the player rolls 2D6. On a result of 5 or better, the strike clears the minefield. Mines cleared in this way do no damage, and clearing artillery fire does not affect adjacent hexes in any way. However, artillery fire does normal damage to units occupying the mined hex.

**Missiles:** A player may use an LRM-20 or MRM-20, -30, or -40 salvo to clear a minefield (but not an SRM). The player must designate the attack to clear the minefield. When the attack hits the hex, the player rolls 2D6. On a result of 5 or better, the strike clears the minefield. Mines cleared in this way do no damage. Missile salvos fired to clear a minefield do not affect adjacent hexes in any way.

### NIGHT COMBAT

A lack of ambient light degrades the ability of BattleMechs and other combat units to target and hit an opposing unit. If combat takes place at night, modify all to-hit numbers by +2.

### SEARCHLIGHTS

Some BattleMechs are equipped with searchlights. These units will be designated by the scenario being played or by mutual player consent. In some cases, a BattleMech's illustration or miniature will show that it has a searchlight, such as the *Guillotine* and *Loki*. Searchlights take up no weight or space for purposes of construction.

BattleMechs equipped with searchlights may turn their searchlights on (or off) during the Movement Phase. A searchlight illuminates any one unit or hex in its LOS and in its forward firing arc during any attack phase, as well as any units in intervening hexes between the illuminated unit and the searchlight-equipped unit. The unit also illuminates itself. Units attacking illuminated units disregard the +2 modifier for night fighting.

Each time a searchlight-equipped BattleMech takes a hit in any torso location (Front or Rear), or when a searchlight-equipped vehicle takes a hit to the Front or Side, the player must roll 2D6 to determine if the searchlight is destroyed. A result of 7+ means the searchlight is destroyed, in addition to the normal effects of the attack.

### REVERSING ARMS

BattleMechs constructed without hand and lower arm actuators in either arm have the ability to flip their arms over and fire backward. This ability only applies to 'Mechs originally constructed lacking those actuators, not 'Mechs that lose them due to critical damage.

A BattleMech that intends to reverse its arm-mounted weapons must flip both arms during the weapon attack declaration. This maneuver takes the place of a torso twist. When it flips its arms, the BattleMech may then fire any arm-mounted weapon into the rear firing arc instead of the usual firing arcs for those weapons.

**Prone 'Mechs:** Since a prone 'Mech may not torso twist, it also may not reverse its arms.

## SCAVENGING AND REPAIR

In standard *BattleTech* play, each scenario begins with a fresh, undamaged batch of 'Mechs. One way to make back-to-back scenarios more challenging is to run multibattle campaigns in which each opposing side starts play with a set number of 'Mechs. Rather than receiving new 'Mechs at the start of each scenario, however, players must make it through the entire campaign using only the units allotted at the beginning of play. The scavenging and repair rules provide a system for scavenging parts from fallen 'Mechs and repairing and customizing units—capabilities that make such a campaign possible. With these rules, a player can repair any BattleMech or vehicle not destroyed, then throw the repaired unit into the next fight. By salvaging parts from fallen enemy units, a player can keep his own troops at fighting strength while crippling his opponent's ability to recover from battles.

The following rules apply to BattleMechs and vehicles only.

## TECHNICIANS

Many of the following rules require Technician Skill rolls. This reflects the importance of technicians, who are vital to the survival of any thirty-first-century fighting force. (Without technicians, repairs would be difficult, retrofit modifications impossible, and even reloading ammo a challenge to the MechWarrior in the field.)

If you are using the *MechWarrior* roleplaying game or have created a complete unit roster with rules from another *BattleTech* product, you will likely have a list of available techs who work with your unit, along with their skill levels. In this case, use the appropriate character's skill target number in Technician/BattleMech (or Technician/Mechanic, if working on vehicles) along with any appropriate modifiers when making the required Technician Skill rolls.

If you are not using *MechWarrior* rules, simply assume that each BattleMech and vehicle in your force has its own technician. The skill of a unit's technician equals the experience level of the MechWarrior/driver/pilot of the unit. For example, a 'Mech with an Elite MechWarrior would have an Elite technician. The base skill target numbers for the various experience levels appear in the Technician Experience Table.

### Technician Exclusivity

A technician assigned to a 'Mech or vehicle works on that unit unless it needs no repairs. If his assigned unit needs no repairs or the technician can finish those repairs and has time to spare, he can help another technician work on a different machine. Two technicians cannot work on the same task at the same time, but they can divide the tasks between them to save time.

### Technician Types

Technicians assigned to 'Mechs have the Technician/BattleMech Skill and vehicle techs have the

## TECHNICIAN EXPERIENCE TABLE

Experience Level	Technician Skill Target
Green	9+
Regular	7+
Veteran	6+
Elite	5+

Technician/Mechanic Skill. Each of these types of technician can work on other types of units, but they must roll 3D6 when making Technician Skill rolls and use the lowest two die results as the final result. This reflects the fact that all technicians possess similar general abilities, but they lack the specific training to work on other types of units very effectively.

## DIAGNOSIS

Before repairing a damaged 'Mech or vehicle or salvaging parts from it, the tech must determine the status of its components. In certain cases, components may be so badly damaged that they cannot be repaired or salvaged.

### Destroyed vs. Truly Destroyed

In standard *BattleTech* play, the term "destroyed" is used to describe the condition of units that are "mission kills"—units that have been killed or otherwise rendered inoperable for the length of a scenario. In most cases, such units can be repaired or used for salvage parts after the scenario ends.

Certain situations, however, leave a unit destroyed in the truest sense of the word—completely ruined, nonrepairable and with no salvageable parts.

A BattleMech is only "truly destroyed" if its center torso internal structure is completely eliminated by artillery damage while in the target hex of an area-saturation artillery attack, or by damage from an ammo explosion. If a 'Mech's center torso is destroyed in some other way, the 'Mech's remaining parts may be salvageable.

**Vehicles:** A vehicle is truly destroyed if any one of its hit locations—except for turret or rotor locations—is completely eliminated by artillery damage while in the target hex of an area-saturation artillery attack.

### Limb/Section Status

Any 'Mech limb or body section that is destroyed (or is blown off and unable to be reattached) can be replaced entirely. The replacement need not come from the same model 'Mech, but it must come from a 'Mech of the same tonnage. The type of internal structure and myomer must also match.

Shoulder and hip actuators are integral to the limb structure of a BattleMech; if a limb's shoulder or hip actuator cannot be repaired, the entire limb must be replaced.

The center torso of a 'Mech cannot be replaced. If all the center torso's internal structure is damaged, the 'Mech cannot be repaired. For vehicles, only turrets and rotors can be replaced. If any other section is destroyed, the vehicle cannot

be repaired. However, unless the 'Mech or vehicle took the damage in one of the ways described in *Destroyed vs. Truly Destroyed*, any remaining components of the unit may be salvageable.

A limb or head that has been blown off by a "Limb Blown Off" result on the Determining Critical Hits Table can be reattached. It suffers no additional damage from being blown off, even if it is picked up and used as a club.

### Component Status

Weapons, engines, sensors, and any other equipment that has suffered critical damage during the game may have been destroyed beyond repair.

If every critical slot of the component has been destroyed, roll 2D6. On a result of 10 or greater, the component can be repaired. If the result is lower, the component is damaged beyond repair. The same rule applies to all components contained in a destroyed location (a location in which all internal structure is destroyed). Make a separate roll for each component or weapon.

Items that have at least one undamaged critical slot can always be repaired.

Components in a limb that has been blown off by a "Limb Blown Off" result on the Determining Critical Hits Table retain whatever status they had while attached to the BattleMech. This means an undamaged item in that limb is still undamaged, so it can be removed and installed in another 'Mech.

### Armor and Internal Structure

Armor "boxes" that are damaged must be replaced; they cannot be repaired. On the other hand, damage to internal structure can be repaired, unless a location's entire internal structure is destroyed. In this case, the entire location must be replaced.

### Hull Breach

Locations that suffer hull breaches during underwater operations (p. 89) or while operating in vacuums (p. 79), are inoperable for the duration of the scenario. After the battle, the location can be repaired by drying out the area, replacing seals and wires and performing other miscellaneous work. This process requires no dice roll, only the required time listed on the Master Repair Table (p. 86). Once this time is spent, the components in the damaged location work normally. Other damage suffered by that location prior to and after the breach must be repaired normally.

### OBTAINING REPLACEMENT PARTS

To replace destroyed or badly damaged parts, a technician needs appropriate replacement parts. Technicians can obtain replacements in two ways: by buying brand-new parts or salvaging parts from other units.

No fighting force is assumed to have a supply of new parts unless both players agree to this condition before starting play. If the players want to exercise this option, both start with the same C-bill allowance for parts and ammunition. (For a ballpark figure, start at 500,000 C-bills per lance or Star, multiplied by

the expected number of games in the campaign). Then each player may use his allowance to buy new parts during the campaign.

The Weapon and Equipment Prices Table on p. 138 lists the costs of various components and weapons. Note that any item on the BattleMech Cost Table with a price formula that includes "Tonnage" must be purchased for a particular tonnage 'Mech. For example, a hand actuator for an 80-ton 'Mech costs 640 C-bills and can only be mounted on an 80-ton 'Mech.

The following entries describe some special component-cost rules.

### Engines

Because engine costs are based on the tonnage of the unit and its engine rating, engines must be matched to the unit's tonnage and Walking MP. For this reason, quartermasters rarely stock replacement engines.

### Jump Jets

Jump-jet repairs actually consist of replacing critically damaged exhaust ports. The cost of each exhaust port (critical slot) equals the tonnage of the unit multiplied by 200. The extra cost shown on the Cost Table represents the additional cost for installing an entire jump jet system on a unit.

### OmniMechs

Items to be used as OmniMech pods (see p. 120) are easier to install but can only be used on OmniMechs. Furthermore, such items receive an additional cost multiplier of 1.25. The final cost includes ammunition, which comes in special pods designed for OmniMechs. However, the ammunition in a pod can be removed and loaded into a non-OmniMech unit.

### Heat Sinks

Spare heat sinks cost 2,000 C-bills each. Spare double heat sinks cost 6,000 C-bills each.

## SKELETON/MUSCULATURE BASE COSTS TABLE

Equipment	Cost (in C-bills)
Internal Structure	
Standard	Tonnage x 2,400
Endo Steel	Tonnage x 3,600
Triple-Strength Myomer	Tonnage x 16,400
Endo Steel and	
Triple-Strength Myomer	Tonnage x 17,600

### Limb/Head/Body Section

The cost of replacing a limb, head or body section is equal to 10 percent of the total cost of the 'Mech's combined skeleton and musculature. The base cost for an entire skeleton and musculature is summarized in the Skeleton/Musculature Base Costs Table.

## SPECIAL CASE RULES

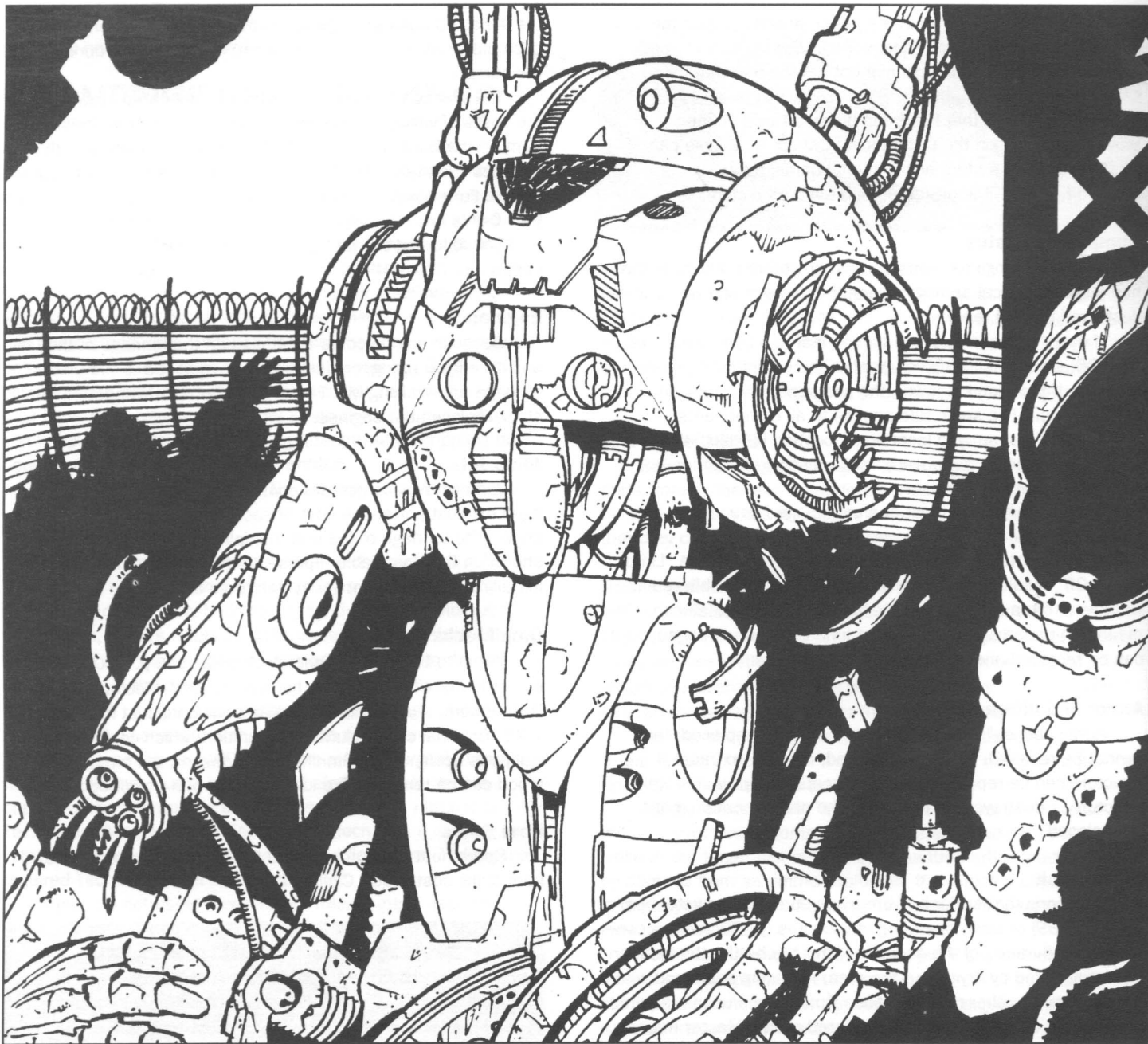

To calculate the cost of a replacement limb/head/body section, divide the 'Mech's total skeleton/musculature cost by 10. All limb/head/body section costs include all internal structure in the section. However, actuators, armor, weapons and other equipment in the location must be purchased and installed separately. For example, a replacement leg for an 80-ton 'Mech with standard myomer and structure costs 19,200 C-bills:  $(80 \times 2,400) \div 10 = 19,200$ . However, the replacement leg is empty and needs leg actuators for an additional cost of 28,000 C-bills.

The base cost for replacing a 'Mech head does not include the cost of the head's cockpit, sensors and life-support system. However, replacement heads always contain these items, so the additional costs must be paid when buying a head.

As previously noted, 'Mech center torsos cannot be replaced.

**Vehicles:** The costs of replacement vehicle turrets and rotors are listed on p. 137. Other vehicle sections cannot be replaced.

### SCAVENGING

Most units acquire parts by scavenging—salvaging them from fallen enemies and their own badly damaged machines. Scavenging enables players to replace 'Mech parts without having to buy new ones.

Components that have been destroyed (see *Diagnosis*, p. 82) cannot be salvaged. BattleMech center torsos and vehicle

## SPECIAL CASE RULES

locations other than turrets and rotors also cannot be salvaged. However, any component listed on the Master Repair Table (p. 86) can be scavenged, including entire limbs and body sections.

To scavenge a part, a player must make a successful Technician Skill roll, using the appropriate modifier listed for the part on the Master Repair Table. Scavenging the part also requires the base time shown on the table (parts can be scavenged more quickly by using the Rush Jobs rule, p. 87).

If the roll succeeds, the part is scavenged successfully. If the roll fails, the part was not successfully removed. A technician may not attempt to scavenge the same part twice, nor may another technician of the same or lower experience level attempt the job. Only a technician with a higher experience level may attempt to scavenge the part after a failed attempt. If an Elite technician fails to scavenge a part, the part cannot be removed without destroying it.

Whether the Skill Roll succeeds or fails, the required time is still spent by the technician.

### REPAIRS AND REPLACEMENTS

After obtaining the necessary parts, players can perform repairs, replacements or partial repairs. The following rules describe the process of making such repairs.

All repairs require Technician Skill rolls. When performing repairs and replacements without proper equipment or in difficult conditions (for example, in a tent one kilometer from the front lines), apply a +1 modifier to the target number.

#### Repairs

The term *repair* means returning a component to working order without replacing it entirely. This requires a skilled technician and a stock of tools and miscellaneous parts but does not require specific replacement parts. Repairs are cheaper than replacements but are more difficult to accomplish and less reliable.

To repair a part, a technician spends the time listed on the Master Repair Table, p. 86, and then makes a Technician Skill roll, modified as shown on the table. If the roll succeeds, the repair succeeds. If the roll fails, the component is still damaged. (However, certain components may be partially repaired on a failed Repair Roll—see *Partial Repairs*, p. 85). A technician may not attempt to repair the same part twice, nor may another technician of the same or lower experience level attempt the job. Only a technician with a higher experience level may attempt to repair the part after a failed attempt. If an Elite technician fails to make the repair, it is impossible and the part must be replaced.

#### Replacements

If a component is completely destroyed, or an Elite technician has failed to repair it, the component must be replaced. Any component listed on the Master Repair Table (p. 86) can be replaced, including entire limbs and body sections. The only parts of a unit that cannot be replaced are the center torso of a 'Mech, or any locations on a vehicle except the turrets and rotors.

The first step in performing a replacement is obtaining the necessary part (see *Obtaining Replacement Parts*, p. 83). Then the technician must spend the required time and make a Technician Skill roll, with the modifier shown on the Master Repair Table. Apply an additional +1 modifier if the replacement component has been salvaged (as opposed to new). If the roll succeeds, the part is installed and functions like new. If the roll fails, the replacement fails and the part is not installed. (However, certain components may be incorrectly installed on a failed Replacement Roll—see *Partial Repairs* below).

A technician may not attempt to replace the same part twice, nor may another technician of the same or lower experience level attempt the job. Only a technician with a higher experience level may attempt to replace the part after a failed attempt. If an Elite technician fails to install a part, the replacement part is destroyed during the installation attempt, but a new part may be obtained and installed. For this reason, most technicians choose to be especially careful and spend extra time (see *Extra Time*, p. 87) when installing expensive new parts.

**Clan/Inner Sphere Incompatibility:** For any attempt to use a Clan component to replace an Inner Sphere one (or vice versa), add an additional +4 modifier to reflect the basic incompatibility of the two technologies.

#### Partial Repairs

Depending on the part being repaired or replaced, a failed Technician Skill roll may result in a component being partially repaired or incorrectly installed. Any component with a Partial Repair value listed on the Master Repair Table (p. 86) may be partially repaired or incorrectly installed in this manner. The value is the highest amount by which the roll may fail and cause a partial repair or faulty installation. For example, if the Target Number is 8 and the player rolls a 6, the roll failed by 2. A component that is partially repaired or incorrectly installed will produce the effects listed in the Partial Repair Effect column on the table. In all other respects, the component functions normally.

A technician performing the repair/replacement will think he did a complete job, so at least one game must pass before the partial repair can be corrected. At that point, a technician with a higher experience level may attempt to correct the partial repair. If the partial repair was made by an Elite technician, the effects are permanent and remain even if the part is salvaged and properly installed in a different unit.

A technician may not attempt to repair or replace the same part twice, nor may another technician of the same or lower experience level attempt the job. Only a technician with a higher experience level may attempt to repair or replace the part after a failed attempt. If an Elite technician fails to make the repair/replacement, a new part must be obtained and the installation attempt repeated.

Note that heat sinks that are partially repaired work at only half capacity (round down fractions). For example, a unit with three partially repaired single heat sinks would lose 2 points of its heat-dissipation capability.

# SPECIAL CASE RULES

## MASTER REPAIR TABLE

Damage	Target Number Modifier*	Partial Repair**	Partial Repair Effect	Base Time (in minutes)
<i>Replacements</i>				
Destroyed Location	+4	—	—	240
Blown-Off Limb	+2	—	—	180
Blown-Off Head	+3	—	—	200
Armor (per location)	-1	—	—	15 per box
Engine	0	1	+1 Heat Point/turn	360
Sensors	+1	—	—	260
Life Support	0	—	—	180
Jump Jet	+1	—	—	60
Heat Sink	-1	—	—	90
Actuator	-2	—	—	90
Gyro	+1	2	+1 Piloting modifier	200
Weapons and Other Equipment	+1	—	—	120
OmniMech Pod (per location)	-4	1	Double repair time	30†
<i>Vehicles</i>				
Turret	0	—	—	160
Rotors	+1	—	—	300
Clan/Inner Sphere Incompatibility	+4	—	—	—
<i>Repairs</i>				
Internal Structure (per location)				
Up to 1/4 damage	+0	1	1 pt permanent damage	90
Up to 1/2 damage	+1	1	2 pts permanent damage	135
Up to 3/4 damage	+2	2	3 pts permanent damage	180
More than 3/4 damage	+3	2	4 pts permanent damage	270
Engine				
1 critical hit	0	2	+3 Heat Points/turn	100
2 critical hits	+1	3	+5 Heat Points/turn	200
3+ critical hits	+3	4	+8 Heat Points/turn	300
Sensors				
1 critical hit	+1	3	+1 to-hit modifier	75
2 critical hits	+4	4	+2 to-hit modifier	150
Gyro				
1 critical hit	+2	3	+1 Piloting modifier	120
2+ critical hits	+5	4	+2 Piloting modifier	240
Life Support				
1 critical hit	0	—	—	60
2 critical hits	+2	—	—	120
Jump Jet	+1	1	+1 Heat Point when jumping	90
Heat Sink	0	3	Heat sink operates at 1/2 capacity	120
Actuators	-1	—	—	120
Hull Breach (per location)	—	—	—	60†
Weapons and Other Equipment				
1 critical hit	-2	—	—	100
2 critical hits	-1	—	—	150
3 critical hits	+1	—	—	200
4+ critical hits	+3	—	—	250
Vehicles				
Turret locked	-1	1	Turret starts next game jammed in forward firing position	90
Rotor damage (per hit)	+2	—	—	120

\* Add an additional +1 modifier if using salvaged parts instead of new parts. Apply an additional +1 modifier for work done under difficult conditions, and/or without proper tools.

\*\* If the Repair Roll fails by an amount equal to or less than this value, a partial repair is achieved (see *Partial Repairs*, p. 85).

† This time cannot be modified by the *Extra Time* or *Rush Job* rules.

A Veteran technician is attempting to repair a BattleMech's engine, which has suffered two critical hits. The technician's Base Target Number is 6, modified by +1 for the difficulty of the repair, as shown on the Master Repair Table. The table shows a 3 in the Partial Repair column, which means the engine is partially repaired if the roll fails by up to 3 points (results of 4, 5, or 6). On a roll of 2 or 3, the repair fails.

If the engine is only partially repaired, the engine generates 5 extra Heat Points per turn. (Not good, but an improvement over the 10 extra Heat Points it was generating before it was repaired.) Only an Elite technician can attempt to correct the partial repair and only after at least 1 game has passed.

### Extra Time

To increase the potential for a successful repair/replacement, a player may spend extra time on a repair or replacement job. This is rarely an option on the front lines, but it is standard operating procedure elsewhere.

If twice the required repair time is spent on a job, the Technician skill roll receives a -1 modifier to the target number. The time may be doubled multiple times, but a result of 2 on the dice roll is always a failure, regardless of how low the target number is reduced by taking extra time.

### Rush Jobs

Sometimes conditions (or unit commanders) require a quick turnaround on repairs. Rush jobs are more difficult than standard repairs, and rush repairs are more likely to break down at the worst possible moment.

Any technician with a Regular or higher experience level may perform a rush job. To do so, the technician must voluntarily lower his effective experience level for the duration of the rush job. By reducing his experience level by 1, a technician can make a repair in one-half the usual time; a 2-level experience reduction enables him to make the repair in one-fourth of the usual time; and a 3-level experience reduction enables him to make the repair in one-eighth of the usual time.

However, a technician performing a rush job doesn't have time to test the repair or installation before sending the unit to the field. To reflect this, the controlling player does not make the Technician skill roll at the time of the job. Instead, the roll is made during the next game that the unit participates in, the first time the component is used. Immediately apply the results of a failed Repair/Replacement Roll, partial repair or incorrect installation.

Furthermore, apply an additional +1 modifier to any subsequent attempt to repair, replace, or scavenge an item that has been repaired or replaced with a rush job.

Rush jobs cannot be combined with *Extra Time*.

## CUSTOMIZING AND RETROFITS

Customizing is the practice of installing nonfactory replacement parts in a 'Mech or vehicle to improve or modify the unit's performance.

OmniMechs are designed to use interchangeable modular pods, so they are rarely customized. However, even OmniMech chassis contain certain integral components, such as engines, armor, and fixed weapons. These items are not installed in modular pods, so they must be replaced with customizing procedures.

### Customizing and Construction Rules

Generally, players must follow *BattleTech* construction rules when customizing a unit. You cannot simply strap a couple of new medium lasers onto an existing design, as this would make the unit 2 tons too heavy. Other components must be removed or changed to make the appropriate space and weight available for new systems.

However, players need not observe the standard construction prohibition against mixing technology bases when customizing units. Clan parts can be installed in Inner Sphere units and vice versa, though such modifications may be a bit more difficult than standard replacements. Note that all other standard construction rules still apply. For example, a player could install Clan double heat sinks on an Inner Sphere 'Mech originally equipped with double heat sinks, but he could not install them on a unit originally equipped with single heat sinks.

Use the *Scavenging* rules (p. 82) when removing items from 'Mechs and vehicles. When installing new parts, use the *Repairs and Replacements* rules (p. 85). Botched scavenging or installations can ruin good components, so most customization jobs are done far from the battlefield, where plenty of extra time can be taken.

### Overall Design Integrity

When BattleMechs are designed, their components are placed in certain parts of the 'Mech's body for good reason. The entire structure of the 'Mech must be balanced to support its weapons and other equipment. Changing this arrangement through customization can seriously upset the balance and hinder the performance of a 'Mech.

Therefore, the ideal customization replaces a component with another component that takes up the exact same tonnage and critical spaces in the same location of the 'Mech. For example, replacing an SRM-2 and a ton of ammunition with a medium laser and a single heat sink (each item weighs 2 tons and occupies 2 critical slots) is easy enough. The balance of the 'Mech and its internal-space allocation is maintained. Such customizations do not produce any additional modifiers or other problems.

More radical modifications can cause serious problems. If the tonnage and critical-slot requirements of new parts do not match the requirements of the parts removed, an additional Technician Skill roll must be made to maintain the balance of the design. Make a separate roll for each location that experiences a change in space and/or tonnage. If only the tonnage or critical space is altered, add a +2 modifier to the target number. If both tonnage *and* critical space are altered in the location, apply a +4 modifier. If using the *MechWarrior* roleplaying rules, apply a -2 modifier if the technician has the Engineering Skill.

## SPECIAL CASE RULES

If the roll fails, the design's balance has been disrupted by the customization.

In the case of leg and torso customizations, this imbalance results in a +1 modifier to all Piloting Skill rolls for that 'Mech. This modifier is not cumulative. Once the 'Mech is out of balance, any further tinkering does not increase the +1 modifier.

If the arms or head are unbalanced, any weapon or physical attack from those locations receives a +1 modifier. This modifier applies only to the specific affected location and can be applied only once to any single location.

Design integrity can be restored to a 'Mech by a technician of a higher skill level. If an Elite technician cannot maintain the design's integrity, it has become irrevocably unbalanced.

The design-integrity rule applies to BattleMechs only. Conventional vehicles can be freely modified without loss of performance, due to their open construction and stable frames.

### UNDERWATER OPERATIONS

The following rules describe movement, line of sight, weapon and physical attacks, and hull integrity for units moving underwater. Only BattleMechs and submarines can move underwater. Standing BattleMechs in water of Depth 2 or deeper, prone 'Mechs in Depth 1 water, and submarines at Depth 1 or deeper are considered to be underwater and subject to these rules.

#### MOVEMENT

An underwater BattleMech pays 4 MP for each hex it enters and must make a Piloting Skill Roll using the appropriate modifiers for each Water hex it enters of Depth 2 or deeper. In addition, a BattleMech must pay all standard MP for moving from one level (depth) to another (see Movement Cost Table, p. 18).

**Vehicles:** Submarines pay 1 MP for each hex they enter and 1 MP for each level of depth they change. Submarines cannot use flanking movement while they are submerged.

#### LINE OF SIGHT

Calculate line of sight normally, treating level of depth as negative numbers. For example, a Depth of 1 is at Level -1 and so is 2 levels below a Level 1 hill. Units without a clear line of

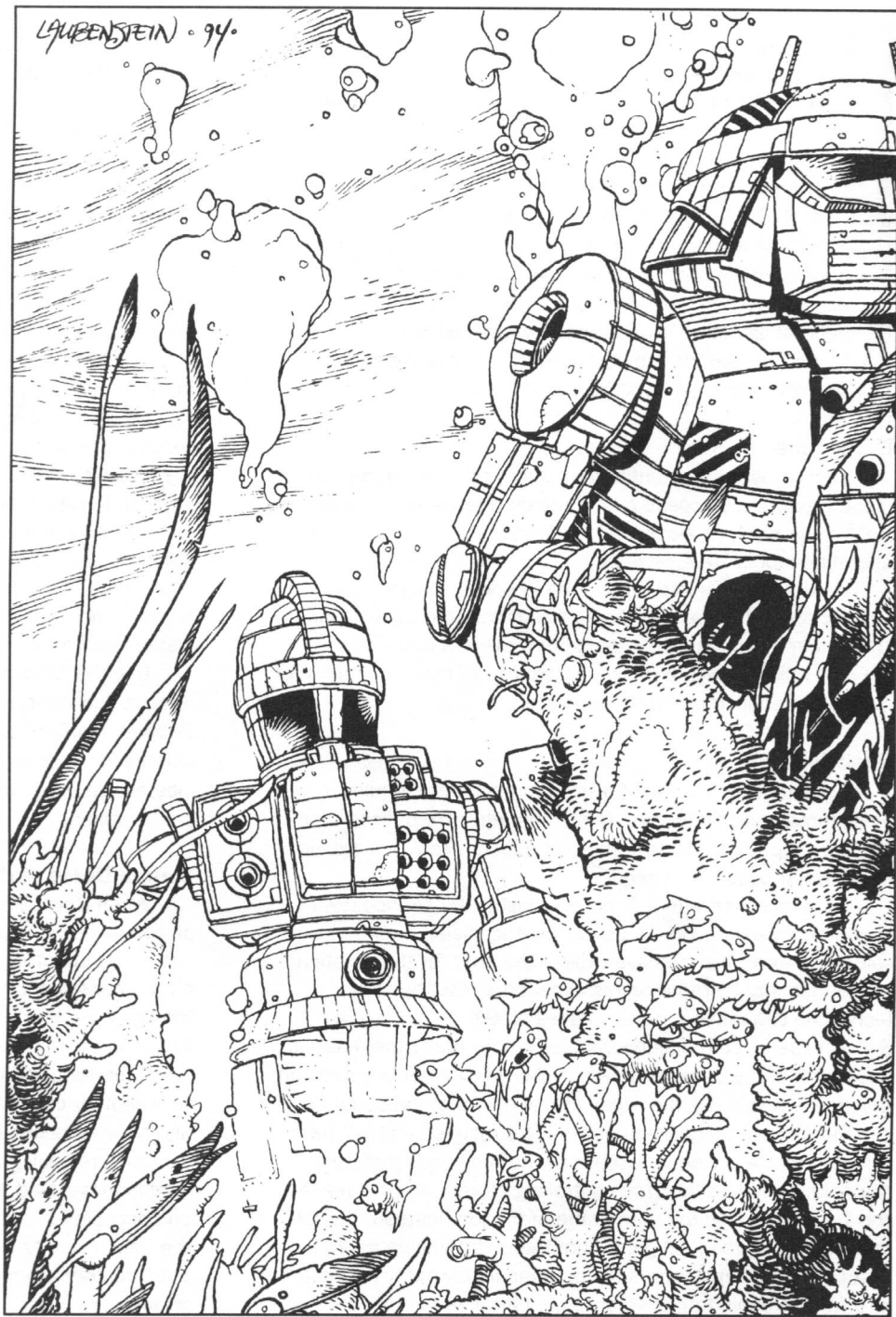

sight cannot attack one another. The Underwater Line of Sight Table summarizes which units can fire at each other, and with what modifications.

#### WEAPON ATTACKS

Units may only fire energy weapons and torpedoes underwater.

Lasers and PPCs may be fired underwater at greatly reduced ranges, as shown in the Underwater Range Table.

## SPECIAL CASE RULES

### UNDERWATER LINE OF SIGHT TABLE

Attacker is:	Target is:				
	Underwater <sup>1</sup>	Surface Naval	Airborne	Ground <sup>2</sup>	BattleMech at Depth 1
Underwater <sup>1</sup>	Yes	Yes	No	No	Yes <sup>4</sup>
Surface Naval	Yes	Yes	Yes	Yes	Yes <sup>3</sup>
Airborne	No	Yes	Yes	Yes	Yes <sup>3</sup>
Ground <sup>2</sup>	No	Yes	Yes	Yes	Yes <sup>3</sup>
BattleMech at Depth 1	Yes <sup>6</sup>	Yes <sup>5</sup>	Yes <sup>5</sup>	Yes <sup>5</sup>	Yes <sup>7</sup>

<sup>1</sup> Includes standing BattleMechs at Depth 2+ and prone BattleMechs at Depth 1.

<sup>2</sup> Includes BattleMechs at Level 0+.

<sup>3</sup> At +2 to hit (+3 for partial cover and -1 for being in water); use the BattleMech Punch Location Table.

<sup>4</sup> At +2 to hit (+3 for partial cover and -1 for being in water); use the BattleMech Kick Location Table.

<sup>5</sup> Can only fire torso, arm or head weapons.

<sup>6</sup> Can only fire leg weapons.

<sup>7</sup> Can only fire leg weapons at legs and upper body weapons at upper bodies (+3 for partial cover and -1 for being in water).

weapons, or other equipment works; if the breached location contains engine slots, the engine now functions as if it took as many critical hits as there were engine critical slots in that location.

Note these are not technically critical hits and, for example, will not cause ammunition to explode. Equipment and components in the breached location can still take critical hits per the standard rules, even though the component is temporarily nonfunctional. Given

### Torpedoes

Torpedoes are short- and long-range missiles specially designed to function underwater, and they use the same stats as their land-based counterparts. Torpedoes may only be fired from and into a Water hex of Depth 1 or greater, and the attacker must trace LOS through Water hexes of Depth 1 or greater. Units equipped with torpedo racks may not use normal missile ammo, and torpedo ammunition will not fit in missile racks.

### PHYSICAL ATTACKS

Submarines and BattleMechs underwater may make physical attacks, but the cushioning effect of the water reduces the damage by half. BattleMechs underwater may not make death from above attacks, but such attacks may be made against them. Death from above attacks executed in this fashion inflict half damage.

Consult the Physical Attacks Against VTOLs Table, p. 58 of *Vehicles*, for the physical attacks a BattleMech may make against submarines and surface naval vessels. Submarines may ram (charge) units at the same depth they currently occupy.

### HULL INTEGRITY

Whenever an underwater unit takes a hit that inflicts damage, the controlling player rolls 2D6. On a result of 10 or greater, the unit's hull has been breached. The integrity of that location has been lost, and it fills with water. Only make this roll for flooding at the moment an underwater unit takes damage, not for a damaged unit that later enters the water. If all of a location's armor is destroyed, that location is automatically breached.

Treat all of a BattleMech's components in a breached location as nonfunctional. None of that location's actuators,

time, a technician can repair such damage (see *Hull Breach*, p. 83 in *Scavenging and Repair*).

Breached locations continue to take damage as usual. Do not transfer combat damage inflicted on a breached location until that location's internal structure is destroyed.

### UNDERWATER RANGE TABLE

Weapon	Min.	Short	Medium	Long
Small Laser	0	1	2	NA
Medium Laser	0	1-2	3-4	5-6
Large Laser	0	1-3	4-6	7-9
PPC	3	1-4	5-7	8-10
ER Micro Laser	0	1	2	NA
ER Small Laser (Clan)	0	1	2	3-4
ER Small Laser (IS)	0	1	2	3
ER Medium Laser (Clan)	0	1-3	4-7	8-10
ER Medium Laser (IS)	0	1-3	4-5	6-8
ER Large Laser (Clan)	0	1-5	6-10	11-16
ER Large Laser (IS)	0	1-3	4-9	10-12
ER PPC	0	1-4	5-10	11-16
Micro Pulse Laser	0	1	2	NA
Small Pulse Laser (Clan)	0	1	2	3-4
Small Pulse Laser (IS)	0	1	2	NA
Medium Pulse Laser (Clan)	0	1-3	4-5	6-8
Medium Pulse Laser (IS)	0	1-2	3	4
Large Pulse Laser (Clan)	0	1-4	5-10	11-14
Large Pulse Laser (IS)	0	1-2	3-5	6-7
Small Heavy Laser	0	1	2	NA
Medium Heavy Laser	0	1-2	3-4	5-6
Large Heavy Laser	0	1-3	4-6	7-9

# MINIATURES RULES



Players who wish to add more visual realism to their *BattleTech* game, can use the following rules to convert the mapsheet rules into a system for table-top miniature play. The benefits of real scale give table-top miniature war gaming three dimensions and make line-of-sight determination easy. The mapsheet becomes a convolution of hills, trees, roads and buildings, a living landscape on which to play out strategies.

These rules assume that players are using Ral Partha BattleMechs, vehicles and infantry figures.

## PREPARING MINIATURES

Players should prepare for miniatures play by assembling (and painting, if desired) their miniatures.

We recommend that players paint their miniatures with water-soluble paints prior to use to add realism and visual excitement to the game. Ral Partha produces an extensive line of acrylic water-based paints that can be used for this purpose, available at most hobby stores, along with brushes and primers.

Miniatures can be painted quickly using the following basic techniques. These do not require a steady hand or even very small brushes. Two good, soft brushes, a No. 000 and a No. 6, will serve the purpose.

Prior to painting a miniature, file off all flash. If any assembly is required, do it now. First, make sure the pieces of the miniature fit together properly. Use a hobby knife or a pin file to clean the joints for a tighter fit. Wash all parts in soap and water and allow to dry, then apply super glue or epoxy to join the pieces together. We recommend a super glue that will fill any gaps. Glue the antenna (if any) onto the model at this time. For a sturdy antenna mounting, drill a placement hole about 1/8 inch deep using a pin vise and a No. 71 drill bit. Finally, use super glue or an epoxy to attach the unit to a hexagonal base, placing the miniature in the center of the base, facing one of the base's hex sides. To fill the recession on the top of the base, use any of a number of fillers available at hobby shops.

Next, make sure that the miniature is completely clean and dry, then spray on a light undercoating of primer. Allow the primer coat to dry thoroughly before beginning to paint the miniature. This allows the primer to bond firmly with the metal miniature and will reduce chipping and flaking.

After the miniature is primed, choose a color scheme and begin painting. For basic painting, choose one color—brown, green or red, for example—and use light, medium and dark shades of this color to paint the miniature. For example, if you plan to give the miniature a basic color scheme of brown, you

# MINIATURES RULES

might choose to use Autumn Gold, Wood Brown and Brown from the Ral Partha *BattleTech* Autumn Colors paint set.

First, use the No. 6 brush to paint the medium shade all over the miniature. Alternately, you can use spray paint to apply the base color. Allow the miniature to dry completely.

Next, mix a wash, which is simply diluted paint, of the dark shade and apply it all over the miniature. To create a wash, mix three parts water or thinner to one part paint, diluting the paint to the consistency of ink.

The wash will gather in the crevices and folds of the miniature, darkening its joints and picking out other details. Applying the wash over the entire miniature dulls and stains the medium shade, making the figure look worn. If you prefer for the miniature to look newer, just use a small brush to wash only specific areas of the model.

Next, dry-brush the miniature with the light shade. To dry-brush, simply dip a soft No. 6 brush into the paint, then brush the paint off on a newspaper until there appears to be no more paint left on the brush. Then lightly dust the miniature with the brush. The remaining paint on the brush will highlight the raised portions of the miniature.

Now, use a small brush to add details. In general, just a few will suffice. For example, paint the cockpit canopies a light blue, add a small amount of color to various pieces of equipment, use a wash of black paint around the muzzles of guns or missile tubes, add red to the tips of any exposed missiles, and paint any antenna wires black.

Finally, paint the base green to match the terrain, and sprinkle some landscaping ground cover onto the wet paint and allow it to dry in place.

It is very important that all playing pieces be mounted on the center of a hex base. The hex base defines firing arcs and is used to determine attack direction, the direction of falls, and the direction that a *BattleMech* is displaced, in much the same way as the hex grid on a *BattleTech* mapsheet.

Orient the front side of *BattleMech* and vehicle miniatures to one of the hex sides. For infantry, use a squad of miniatures to represent a platoon; mount seven infantry figures carrying the same weapon on each infantry hex base. Battle armor Points should have five figures mounted onto a hex base; Inner Sphere battle armor squads should have four troopers mounted. Also paint an ID number on one of the sloping hex sides.

## PREPARING TERRAIN

Once the miniatures are ready, the players will also need to construct the terrain their miniatures will fight on. We recommend that the players create a playing surface that measures at least three feet square. That size allows for enough terrain to be added to make the battlefield interesting. An ideal playing surface measures six feet by four feet or larger.

For beginners, virtually any objects found around the house can be used as miniature terrain. Empty cereal boxes, pipe cleaners and Popsicle sticks can be combined to create useful (if not realistic) game scenery. Once you have gotten used to 3-D gaming, the following suggestions describe ways to represent various terrain features more realistically on the table top.

## CLEAR

For clear terrain, simply cover the table with a green felt cloth. Use ground cover of various shades to liven the field. For ground cover, use landscaping materials, such as lichen and grasses of various shapes and coarseness, which can be found at any hobby shop or store selling supplies for model railroading.

## HILLS

Make hills out of green Styrofoam measuring from 1/2 to 3/4 inch thick. Each piece of Styrofoam represents 1 level of elevation. Construct hills of various levels by cutting and shaping successively smaller contour levels and then stacking them on top of each other. The result should resemble a contour map. Each contour of a hill should be cut and shaped individually, then stacked to make hills of various sizes.

When stacking the levels together, leave enough ledge exposed on the lower levels to allow a mounted miniature to easily stand on them. If the exposed area is not large enough for a mounted miniature to stand on, that section represents a cliff face.

The advantage of using Styrofoam is that it is easy to cut to a desired shape and size. If using white Styrofoam, consider painting the hills green and covering the wet paint with model railroading landscaping grasses. Green Styrofoam can be found in almost any floral shop or hobby and craft store, and even in some hardware stores.

## TREES

Hobby and model railroading shops carry a large variety of trees. To create light woods, make a template base (see below) and mount it with a group of trees, spacing them about 3 inches apart. In addition, mount individual trees on bases 2 1/2 inches in diameter. This combination allows you to create a light forest in a specific shape, and to convert it into heavy woods by placing the single trees in among the trees fixed to the larger template.

The template can be made of any material sturdy enough to support the trees. Paint the template the same shade of green as your ground cloth. For a more realistic look, paint the template and sprinkle landscaping material over it before the paint dries to represent grass.

Another way to create a wooded area is to outline the edge of the forest with lichen, then place individual trees within that border to the density desired. Lichen comes in a wide variety of colors, so it makes great alien terrain.

## WATER

To create rivers, streams, and lakes, use one of the following methods. The simplest is to use pieces of blue felt or cloth to represent water. Another method is to cut a thin sheet of Plexiglas to the dimensions desired. For a more realistic effect, paint the underside of the Plexiglas in varied shades of blue. Use darker blues to represent deeper water, starting with the darkest blue in the center of the glass. Some model railroading suppliers sell ready-made plastic sheets of "water" that can be

# MINIATURES RULES

cut to a specific shape. A simpler, less expensive method is to represent water with dark and lighter blue construction paper. However you choose to represent water, make sure the depth levels can be clearly identified.

## ROADS/BRIDGES

Appropriate materials for representing roads and bridges can also be found at hobby and model railroading shops, including simulated road materials ranging from gravel for dirt roads to more polished imitations of macadam and concrete. Use "Z gauge" scaled bridges—these most closely match the scale Ral Partha uses for its *BattleTech* miniatures.

## BUILDINGS

Buildings appropriate for *BattleTech* miniatures play can also be found at hobby and model railroading shops. We recommend products scaled for micro-armor or "Z gauge" scale model railroading. Resin-cast buildings produced especially for micro-armor gaming are also available, as are kits that allow you to fabricate buildings in plaster to your own specifications (these require quite a bit of time and effort).

If the BattleMechs in your game jump a lot, you might prefer buildings with flat roofs. Remember that each 1/2 to 3/4 inch of height represents 1 level of elevation. Mark the Construction Factor (CF) on the bottom of each building model.

## RUBBLE

You can use anything you have lying around to represent rubble. Broken buildings, pieces left over from making other parts of the terrain, or even other models can be "distressed" using woodworking tools, a soldering iron, and/or a hot knife. Please be very careful using such tools. The result should look like something that was blasted apart or burned down.

## ROUGH GROUND

Construct rough ground using ballast, small bits of lichen, or even twigs and soil. If you glue the material onto a template to define the rough area, it is easy to reuse the terrain.

## SWAMP

We recommend creating a water template colored green, brown, or black to represent murky water. Add small bits of lichen to the template to indicate reeds and tufts of swamp grass.

## SMOKE

Smoke can be simulated using cotton balls, and if you wish, you can apply gray or black paint to make them look more realistic.

## RULES CONVERSIONS

The following rules conversions make it possible to run *BattleTech* battles on nongridDED terrain. These simple adjustments do not alter the basics of the *BattleTech* rules system, with the exception of line of sight. Unless otherwise noted, use all standard *BattleTech* rules.

To play a *BattleTech* miniatures game, players need tape measures, straightedges, dice and filled-out record sheets. Before beginning play, set up the table's terrain in a fashion agreeable to all players. Use landscaping grasses to blend in the cracks between templates, if desired.

It should be noted that the miniatures rules are by necessity a bit vaguer than the standard hex-based rules. The lack of hexes, and often of clearly delineated elevation levels, means that players will sometimes be called on to use their own judgment to decide what rule applies, especially when determining line of sight. To ensure smooth game play, players are encouraged to be reasonable in their application of these rules. Due to the nature of miniatures play, there will be times when both players will disagree on a point. In these situations, instead of letting the game bog down into a series of arguments, simply roll a die to settle the dispute and move on with the game.

**Gridded Terrain:** Some manufacturers produce terrain that is already gridded into hexes. If using such gridded terrain, use the *BattleTech* rules in this book as written rather than these miniatures rules.

## SCALE

In *BattleTech*, a standard hex is 30 meters across and 1 level of elevation equals 6 meters. This scale needs to be converted to inches. A realistic conversion compared to the scale of the miniatures is 1 inch = 7.5 meters (1 hex = 4 inches), but movement speeds and weapon ranges become extremely large at that scale. For most playing surfaces, a horizontal scale of 1 inch = 15 meters provides the best size. For this reason, we will assume that scale is being used in these rules.

Players may also use metric measurement. If using a 1 inch = 15 meters scale, assume 1 cm = 6 meters (players using metric measurement will need to adjust all other measurements given in these rules accordingly).

Unless otherwise noted in the rules below, when the mapsheet rules specify a certain number of hexes, multiply that number by 2 (or 5 in the case of centimeters). For example, if a skid would result in a BattleMech sliding 3 hexes, move the miniature 6 inches (or 15 cm).

When a full hex is set on fire, or the terrain is converted or full of smoke, measure a circle around a single point on the table. The radius of this circle should be 1 inch. When an event affects a target hex and all adjacent hexes, draw a circle with a radius of 3 inches. For these purposes, it helps to have a few precut templates handy to represent these kinds of effects.

A miniature represents a unit as large as its base. If an effect touches a miniature's base, that unit is affected. If the effect is fire, that unit is standing in fire. If the effect is smoke, that unit is surrounded by smoke.

## MOVEMENT

In miniatures play, a unit is moved a number of inches rather than a number of hexes. To convert a unit's Movement Points, multiply the unit's Walking (or Cruising) and Jumping MP by 2. Recalculate the unit's Running (or Flank) MP based on its new Walking (or Cruising) MP.

# MINIATURES RULES

## THOR MOVEMENT POINTS

	BattleTech Rules	Miniatures Rules
Walking MP	5	10
Running MP	8	15
Jumping MP	5	10

## MOVEMENT COSTS TABLE

### Terrain/Action

Clear	1 MP/inch moved
Road/Paved/Bridge	1 MP/inch moved
Rough	2 MP/inch moved
Light Woods	2 MP/inch moved
Heavy Woods	3 MP/inch moved
Light Building or Rubble	4 MP
Medium Building	6 MP
Heavy Building	8 MP
Hardened Building	10 MP
Water	
Depth 0	1 MP/inch moved
Depth 1	2 MP/inch moved
Depth 2+	4 MP/inch moved
Elevation Change	
Gradual Slope	+1 MP/inch moved
Mech, VTOL, Sub	+2 MP/level
Infantry, Ground	+4 MP/level
Facing Change	2 MP/hexside
Dropping to the Ground	2 MP
Standing Up	4 MP

For example, a *Thor's* Movement Points would be converted as shown above.

The Movement Costs Table shows the conversion for terrain type and physical action.

Note that movement costs for entering terrain are the same as in standard *BattleTech*, while actions such as standing up and changing elevation, whose MP costs reflect spending time rather than covering distances, are multiplied by 2.

Accomplish movement in the same way as in the standard game: players declare whether the unit is standing still, walking, running, or jumping, all of which provide a set number of MP. A BattleMech or vehicle can only move directly forward or backward, as normal.

Measure facing changes for BattleMechs and vehicles by how many hexsides the unit turns. To determine this, place a straightedge along one side of the hex base and rotate the unit so that it is facing in the desired direction. Beginning with the first hexside (one of the six sides of the miniature base) that passes the straightedge, count the number of full and partial hexsides that pass the straightedge. This is the number of hexsides that the unit turned at that point in movement.

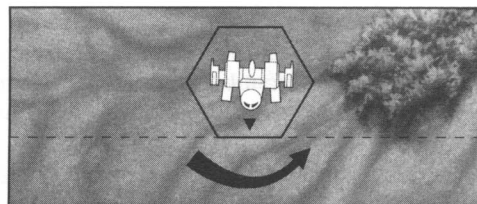

Initial Facing

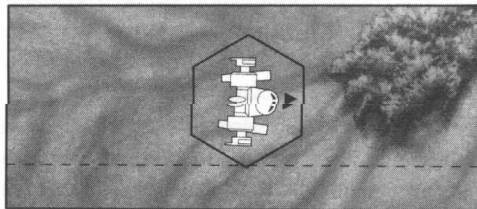

Final Facing

The Jenner wants to turn to the left. The controlling player lays a straightedge along the front of its hex base, and the BattleMech is rotated to the left to face the desired direction. The unit turned 90 degrees; one full and one partial hexside passed the straightedge. This maneuver costs the Jenner 4 MP.

To move a unit, measure from the front of its hex base. The unit must spend MP for each inch or fraction of an inch of terrain that it moves through. The unit is considered to have entered a terrain type if any portion of its base enters that terrain. (If using templates for terrain, a unit enters terrain if it even partially overlaps the template for that terrain.)

A jumping unit only pays one MP per inch traveled, regardless of the terrain that it passes over. Heat is generated at a rate of one point per 2 inches jumped (or fraction thereof), with a minimum of 3 Heat Points generated regardless of jump distance.

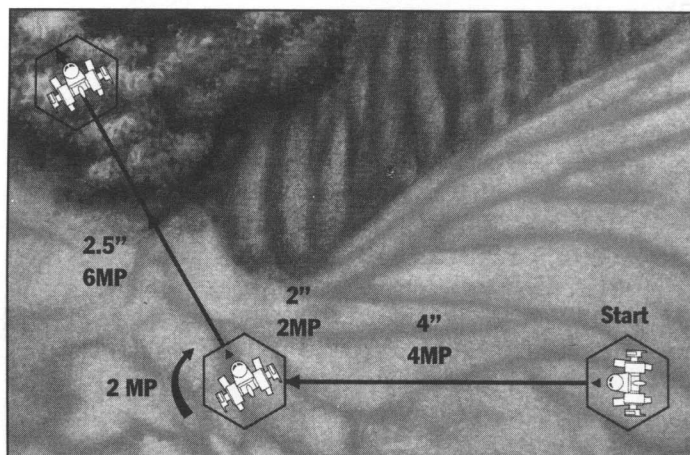

The Jenner wishes to move into firing position in the Light Woods template to its right. It moves 4 inches forward through Clear terrain (4 MP), then turns one hexside to the right (2 MP) and moves 4 1/2 more inches forward, 2 of which are in Clear terrain (2 MP) and 2 1/2 inches in the Light Woods (6 MP). The total movement cost for this maneuver is 4 + 2 + 2 + 6, for

# MINIATURES RULES

a total of 14 MP. Note that even though the Jenner only moved through 2 1/2 inches of Light Woods terrain, it paid the MP for a full 3 inches of movement.

## Elevations

Determining elevation levels requires a certain degree of judgment on the part of both players. If the terrain being played on has clear breaks between elevation levels, it is a simple matter to charge a unit MP as it crosses each elevation level. On the other hand, if the terrain is more gradually sloped, it is difficult to determine where a particular level begins or ends. Use the following guideline when moving on such sloped terrain.

Gradually sloping terrain costs no additional movement to cross. In effect, these kinds of hills function as ramps and facilitate elevation changes. The players may, however, decide that the grade of the slope should be considered steep. In general, if the miniature itself can't stand on the slope without falling over, it is a steep slope. A steep slope costs 1 extra MP per inch moved to climb.

## STACKING

Units cannot be stacked in the miniatures game. As in standard play, units may move through friendly units but may not stop with their bases overlapping.

**Infantry:** Infantry units whose bases are touching a BattleMech's base may engage in anti-BattleMech attacks as described in the Anti-BattleMech Infantry rules, p. 67. Infantry units may mount a vehicle if their base touches the vehicle's base within the guidelines given in *Infantry Carriers*, p. 59 of *Infantry*. While mounted, the infantry miniature is removed from the map. When dismounting, an infantry unit may place itself anywhere adjacent to its vehicle.

## Obstructions

Buildings, elevations and other obstructions only affect a unit's movement if the unit's base will move over them. Overhanging arms, turrets and so on have no effect on the "size" of the unit for this purpose. As long as the unit's base can fit through a gap, the unit can fit, even if the miniature itself seems too big.

## PILOTING SKILL ROLLS

Piloting Skill rolls are made as per the standard rules. In the case of Piloting Skill rolls required by moving through terrain, only make one Piloting Skill roll per 2 inches (or fraction thereof) of the terrain that requires the roll.

## Falling

While aesthetically pleasing, it is best not to lay a fallen BattleMech miniature on its side. Players need to use the 'Mech's base to determine the BattleMech's actual location and orientation for combat purposes and future movement. If players really want to lay their miniatures prone, use a blank hex base to mark the actual location of the BattleMech.

Apply damage from a fall as normal. For these purposes, assume that each 1/2 inch of a building's height is equal to 1

elevation level (round up to the nearest multiple of 1/2" when determining height).

## COMBAT

Resolve combat in the same manner and sequence as in the standard *BattleTech* game, unless otherwise noted below. Note that when falling, skidding, or being pushed, the orientation of a unit's base indicates the direction that the unit will move.

## Line of Sight

The use of 3-D terrain and miniatures makes determining line of sight (LOS) very simple. The players need not worry about the exact level of terrain to determine what is intervening and what is not. Instead, the player need only look toward the intended target from the attacking miniature's perspective to determine if the target can be seen. This can be done by crouching down to get a "miniature's-eye view" of the battlefield. If this is not possible, use a straightedge. For this purpose, a thin wooden dowel or a narrow but sturdy tape measure is best, because you may need to poke the straightedge through woods or other tight spaces to check for LOS. A high-tech alternative is to use a laser pointer to check line of sight, but such tools are fairly expensive. Obviously, the players must exercise fair judgment to determine LOS when conflicts occur.

LOS should be sighted from the torso of the attacking miniature (looking over its shoulders), not its feet or the tip of its head. If any portion of the miniature to be attacked is visible to the firing unit, there is LOS. Water is a special case, because the depth of the water is normally not represented accurately on the table top. The miniature instead stands on the surface of the water, and the players must imagine that it is submerged. If the target is in Level 1 Water, sight the bottom half (waist down) of the 'Mech only. If the attacker is in Level 1 Water, sight from its legs rather than its torso. As usual, an attacker or target in Level 2 or deeper water is completely concealed.

Partial cover is not determined in the usual way when using miniatures. If any part of the target is obscured by a building, hill or water, do not apply the partial cover modifier of +3 to the to-hit number. Instead, resolve the shot normally with only a +1 modifier. When determining hit locations, any shots that hit an area of the target concealed by terrain hit the terrain instead of the target, and inflict damage on it in the case of intervening buildings. Shots that strike other areas of the target are resolved normally.

As in standard *BattleTech*, woods do not create partial cover. If using templates to represent wooded areas, LOS is blocked by 3 or more "points" of woods. Each full 2 inches of Light Woods is one "point" of woods, while each full 1 inch of Heavy Woods is considered a "point" of woods for this purpose. If using individual tree models to represent trees, woods effects can be determined a bit more realistically. Looking at the target model from the attacking model's point of view, if the target cannot be seen at all, or if only a very small portion of the target is visible, there is no LOS. Otherwise, there is LOS.

# MINIATURES RULES

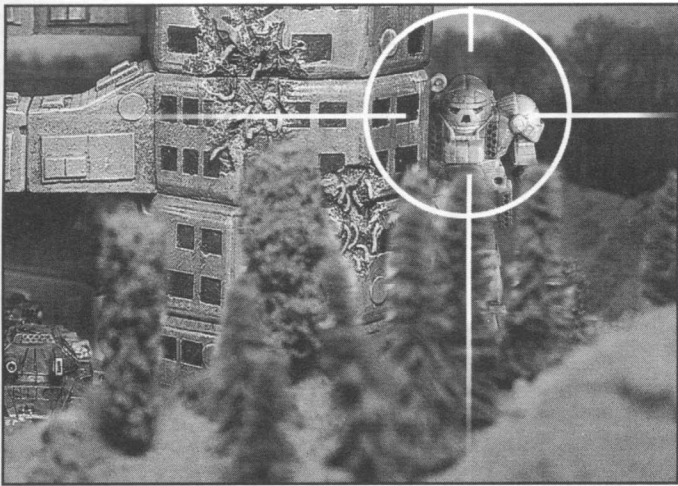

The diagram shows what the target 'Mech looks like from the attacker's point of view. Because a portion of the target is concealed by a building, the to-hit number is modified by +1. If the attack hits, damage that would have struck the right arm instead strikes the building. Other hit locations are resolved normally. The woods do not provide partial cover to the legs.

If the target 'Mech in the previous example chose to return fire against the attacking 'Mech, the 'Mech making the counterattack would not be able to use the weapons in its right arm because this location is blocked by terrain.

## Range

The change in scale makes it necessary to convert weapon ranges in a similar fashion to the conversion used for movement. Multiply the maximum short, medium, and long ranges for all weapons by 2 to determine the table-top distances. For example, an Inner Sphere medium laser would have the following ranges: Short, up to 6 inches; Medium, up to 12 inches; Long, up to 18 inches.

When using miniatures, range is not measured from the center of a hex because it is often difficult to reach the center of a hex base; there are often parts of the miniature in the way. Instead, measure range from the attacker's base to the target's base, using the shortest distance between the two edges. If the target is a building, measure to the part of the building closest to the attacker. If the target is woods or a point on the ground (as for a minefield), the closest point on the template must be targeted. Note that if the distance is even a fraction of an inch greater than the maximum distance for a range, then the next higher range applies.

## To-Hit Modifiers

Use standard to-hit modifiers except for woods. Woods modifiers can be applied differently if the players are using woods templates or if they are using woods models for trees.

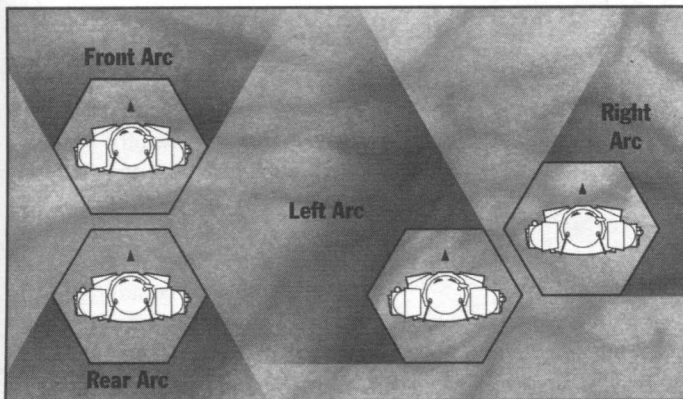

## Firing Arc

Because there are no hexes to guide firing arcs, firing arcs are modified for miniatures play. Use the unit's base to determine the firing arcs by using a straightedge to show the arc of fire as in the diagram. If any part of the target's base lies within the firing arc, it may be attacked in that arc.

However, weapons carried by the attacking 'Mech that cannot be seen from the target's point of view because they are concealed by water, buildings or hills cannot be used to attack the target. In other words, the player making the attack must determine line of sight from the point of view of his own 'Mech, then determine what weapons he can use in the attack by looking at his own 'Mech from the point of view of the target. The exception to this condition is weapons that can be fired indirectly, such as LRMs and artillery. Those weapons can be used to attack but must be fired using the appropriate indirect fire rules.

## WEAPONS FIRE MODIFIERS TABLE: MINIATURES SUPPLEMENT

### Range and Terrain

Minimum Range	+1 at minimum range, additional +1 per 2" less than minimum range
Light Woods	+1 per 2" intervening; +1 if target in Light Woods
Heavy Woods	+1 per 1" intervening; +2 if target in Heavy Woods

### Target

Partial Cover	+1*
Movement	
less than 6"	0
at least 6"	+1
at least 10"	+2
at least 14"	+3
at least 20"	+4
Jumped	+1 additional

\* Partial cover affects the Hit Location roll; see p. 26

# MINIATURES RULES

If using templates to represent wooded areas, apply a +1 modifier to the to-hit roll for each 2 full inches of light woods intervening, and +1 for each 1 full inch of heavy woods intervening. If the target's base overlaps a woods template, it is considered to be in that woods, and the modifier for occupying woods applies.

If using individual tree models to represent trees, woods effects can be determined a bit more realistically. Looking at the target miniature from the attacking unit's point of view, if almost all the target is visible, apply a +1 modifier. If up to half the target miniature is covered by trees, apply a +2 modifier. If more than half the unit is covered by trees, but the target is still visible (i.e., there is LOS), apply a +3 modifier.

Use the Weapons Fire Modifiers Table: Miniatures Supplement on p. 95 to determine the to-hit modifiers for the target's movement. Use only the single highest modifier that applies, plus the jumping modifier if applicable.

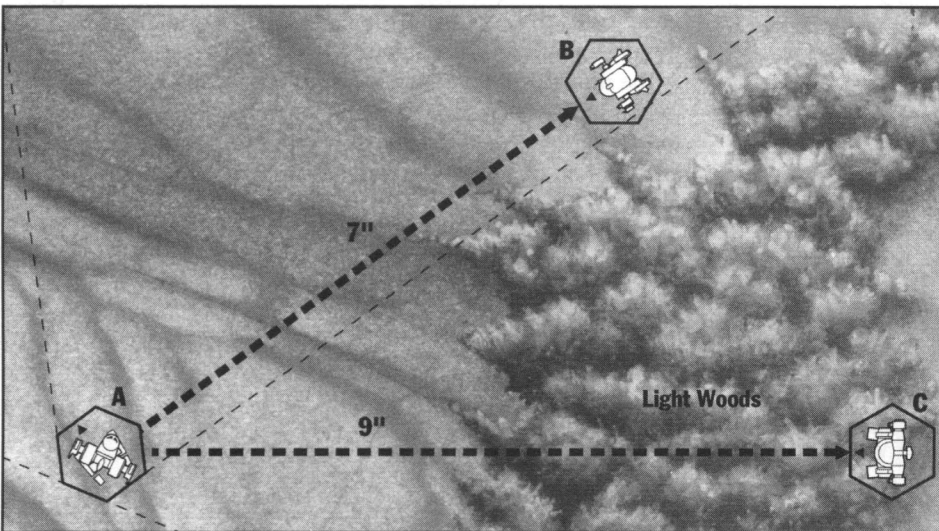

In the diagram, 'Mech A is equipped with an LRM 15 in each arm and 2 medium lasers in the torso. Its torso is twisted to the right and has two possible targets. 'Mech C falls in 'Mech A's right side arc, so only the right arm LRM 15 can be fired at it. The target is 9 inches away, inside the LRM's minimum range of 12 inches. The minimum range modifier would be +2 (+1 for 12 inches, an additional +1 at 10 inches). The shot must also pass through 5 inches of Light Woods, adding a +2 modifier to the shot.

'Mech B is in the front arc of 'Mech A. This means all of 'Mech A's weapons can be fired at 'Mech B, 7 inches away. The LRMs would have a minimum range modifier of +3, but no terrain is in the way. The medium lasers' short range is up to 6 inches, so the target would be at medium range, adding a +2 modifier for range. Needless to say, 'Mech A decides to fire at 'Mech B.

## Attack Direction

Determine the direction of attack normally, substituting the target's base for its hex. Using a straightedge, find the hexside crossed to determine the side on which the unit takes the damage. If the straightedge crosses the intersection between two sides, the target chooses which side takes the hit.

## Physical Attacks

A unit may only make a physical attack if its base is touching the base of the target unit, and only if the target is in the proper firing arc. In all cases, the bases of units displaced because of physical attacks remain touching the base of their attacker, and both units are moved to reflect the displacement.

BattleMechs that are successfully pushed move 2 inches in the direction of the push.

An attacker can only carry out a charging or death from above (DFA) attack if the attacking unit has sufficient MP to

occupy its target's location. If the charge or DFA is unsuccessful, the attacker is displaced as usual, but the bases of the two units continue to touch. If the charge or DFA is successful, the attacker occupies the defender's location and the defender is displaced in the direction of the attack, but the two bases remain in contact.

## ARTILLERY

If using off-board artillery, note its target location by writing down the number of inches from each side of a designated corner of the table the round is to land. In other words, use the edges of the table as the axes of a standard X,Y graph.

Determine scatter by centering a blank hex base on the intended impact point and using the Scatter Diagram in the rules for targeting artillery, p. 70 in *Special Case Rules*. Multiply the number of hexes scattered by 2 to determine by how many inches the round goes astray.

### ARTILLERY DAMAGE RADIUS TABLE

Weapon	Distance from Impact Point	
	up to 1 inch	up to 3 inches
Sniper	10	5
Long Tom	20	10
Thumper	5	2
Arrow IV	20	10

In the standard *BattleTech* game, artillery fire attacks units in the impact hex and in adjacent hexes. Use the Artillery Damage Radius Table to convert this rule

for miniatures play. Units within the stated ranges take the points of damage indicated. Determine attack direction from the impact location of the round.

# BATTLETECH

**DIORAMA:** A *Hankyu* of the 17th Jaguar Regulars tries to disrupt the armor unit of the 1st McCarrons Armored Cavalry. The 6th Lyran Guards confuse the *Hankyu* pilot by fielding a captured Jade Falcon *Black Hawk*, then ambush him with the *Thunder Hawk*.



*Black Hawk (Nova)*, Jade Falcon Eyrice Cluster



*Goblin ISV*, First McCarron's Armored Cavalry  
*Challenger X MBT*, Davion Heavy Guards RCT



*Hankyu*, Seventeenth Jaguar Regulars





**DIORAMA:** Having learned that the Wolf Spider Battalion of the traitorous Wolf's Dragons was defending the planet Pandora in the Lyran Alliance, the Twelfth Falcon Regulars, along with the Jade Falcon Eyrie Cluster, attempt to destroy them in retaliation for the Twelfth's losses to the Dragons' Delta Regiment on Coventry. Luckily, the Sixth Lyran Guards are also on Pandora to help defend the planetary capital of Needgate from the Falcon raid.



**CLN-7V Chameleon**, Wolf Spider Battalion



**TDK-7X Thunder Hawk**, Sixth Lyran Guards



**Loki (Summoner)**, Twelfth Falcon Regulars

**DIORAMA:** Trapped between units from the 91st Division, Tenth Lyran Guards and Davion Heavy Guards RCT, a *Daishi* from the Fourth Jaguar Regulars makes a valiant stand on the planet Schuyler, while a *Black Hawk* from the Fourth Wolf Guards Assault Cluster closes in for the kill.



AS7-S Atlas, Tenth Lyran Guards



SRM Carriers, Com Guards 91st Division



Daishi (Dire Wolf), Fourth Jaguar Regulars





**DIORAMA:** A *Hatchetman* from the 21st Rim Worlds regiment of the Blue Star Irregulars engages in a mock city battle against a *Mad Cat* of the First Wolf Legion of Clan Wolf-in-Exile, on the planet Morges in the Arc-Royal Defense Cordon.



*Mad Cat (Timber Wolf)*, First Wolf Legion Cluster



EMP-6A *Emperor*, First St. Ives Lancers



HCT-5S *Hatchetman*, Blue Star Irregulars

## CREATING SCENARIOS

This section provides rules and tables that can be used to quickly generate *BattleTech* scenarios. Using this system, players can create relatively balanced scenarios in short order, or combine this with the *Battle Value (BV) System*, p. 139, to match the sides more evenly. By combining the various scenario types with various mixes of units and mapsheets, players can create a nearly infinite number of different scenarios.

### GENERAL RULES

Unless otherwise noted in the specific rules for each scenario type, the following rules apply to all *BattleTech* scenarios created with this system.

### NUMBER OF PLAYERS

The mission-generation rules are written for two-player scenarios. If more than two individuals are playing, simply divide all the players into two opposing teams.

These rules can be used to set up games involving three or more sides, but these games tend to become complicated and the players must determine how to apply the rules in various situations.

### SETUP

First, choose a scenario type (see p. 98). Then, select the mapsheets (see p. 100). Determine the force composition (see p. 102), then both players roll 2D6 to begin. The player with the higher result chooses his *home* map edge—the edge of the map where his units will enter. The opposite edge becomes the opposing player's home map edge. A player's units can safely exit the map only through that player's home edge.

Roll Initiative for the first turn per standard rules. All units start play off the map. A player's units may enter the map on any hex along the player's home edge. Each unit must enter the map on a full hex nearest the home edge, and that hex counts as its first hex of movement.

### MOVEMENT AND RETREAT

Scenario maps are fixed once play begins. No new maps will be added to the play area during the game. Unless otherwise noted, units that exit the map at any edge other than their home edge are considered *destroyed*. Units that exit the map through their home edge have *retreated*—they remain out of play for the remainder of the scenario and cannot return. However, retreated units do not count as destroyed units when determining victory.

Units may exit the map by intentionally moving off the map or being forced off by an opposing unit using a push, charge, or death from above attack.

Half-hexes along the edge of the map—even those with hex numbers in them—are not considered part of the map. A unit that enters one of these half-hexes for any reason is considered to have exited the map.

### ENDING THE GAME

Generally, a scenario ends when all of one player's units have been destroyed or have retreated off the map. At that point, the opposing player wins. Depending on the specific scenario type, however, a player may need to achieve additional or alternative goals to claim victory.

### DETERMINING VICTORY

Victory in each scenario goes to the side that survives at the end, or to the side that fulfills specific conditions for victory. Most scenarios include different levels of victory as well: Decisive, Substantial, or Marginal. A given player may win a Decisive, Substantial, or Marginal victory depending on how well he meets the victory conditions.

If you are using the Battle Value system, you can also use an alternate method of determining who wins and the level of victory. Both players start with 0 Victory Points. For every enemy unit destroyed, add twice its point value to your total (include the points for the pilot, if any). For each of your units destroyed, deduct the point value of the unit (plus the pilot) from your score. At the end of the scenario, the side with the most points wins. If the difference between the two players' scores is greater than the number of points used to purchase forces for the winning side, the victory is Decisive. Otherwise, the victory is Marginal. If both players' scores are tied at the end of the scenario, the game is considered a Draw.

(See *Battle Value System*, page 139, for instructions on determining the point values of 'Mechs and other combat units.)

Depending on the specific scenario being played, the victory levels may be determined in various ways. Players can also score Victory Points by achieving certain goals in a scenario (see *Types of Scenarios*, following).

*Players A and B are playing a scenario in which the fighting forces consist of four 'Mechs on each side. All of the 'Mechs are worth 1,000 BV points each, for a total of 4,000 points per side. The scenario ends with Player A destroying all four of Player B's 'Mechs. Player B has only destroyed two of Player A's 'Mechs.*

*Player A scores twice the point value of each 'Mech that he destroyed (2 x 1,000 = 2,000 points each). Because he destroyed all four of his opponent's 'Mechs, he scores 8,000 points (2,000 x 4 = 8,000). However, his opponent destroyed two of his 'Mechs, so Player A must deduct their point value from his score. Two 'Mechs at 1,000 points each equals 2,000 points, reducing Player A's final score to 6,000.*

*The two 'Mechs that Player B managed to destroy give him 4,000 points (2 x 1,000 = 2,000, 2,000 x 2 = 4,000). However, Player B lost all four of his own units. Subtracting 1,000 points each for the 4 destroyed 'Mechs leaves Player B with 0 points.*

# CREATING SCENARIOS

*Player A is the winner of this scenario. Because the difference between the players' scores is greater than the 4,000 points each player used to purchase his forces, the victory is Decisive. If Player B had managed to destroy three of Player A's units, Player A would still have won, but only a Marginal victory.*

## TYPES OF SCENARIOS

If desired, one player may randomly generate a type of scenario by rolling 1D6 and consulting the Scenario Type Table. Alternatively, players may simply select a scenario type.

These general types represent only a few of the possible scenarios that *BattleTech* players can create. You can use these as models to create your own scenarios.

Brief descriptions and victory conditions for each type of scenario are described in the following passages. Each description includes the special rules used to play that type of scenario, along with guidelines for force composition and victory conditions.

### SCENARIO TYPE TABLE

1D6	Scenario Type
1	Standup Fight
2	Hide and Seek
3	Hold the Line
4	Extraction
5	Breakthrough
6	The Chase

### STANDUP FIGHT

In a stand-up fight, the simplest and most common type of scenario, two forces of roughly equal size square off against each other. Only one side will leave the field alive.

### Force Composition

Both sides should have the same number of units. If you are using the BV system, each side should have an equal allotment of points. For example, an appropriate number of points for each side in a lance-on-lance battle is 4,000 to 6,000 points.

### Victory Conditions

The scenario ends when all the units on one side have been destroyed or retreated off the map. The surviving side at the end of the scenario wins. If you are using the point system to build forces, the standard Victory Points and victory levels described in *Determining Victory*, p. 97 apply.

### HIDE AND SEEK

In the hide-and-seek scenario, one player is the attacker, the other the defender. The defending player is "it"—his forces hide, and the attacker attempts to find and destroy them.

Use half the number of mapsheets (rounded up) recommended in the *Selecting Mapsheets* rules, p. 100. If possible, avoid using the Large Lakes or Lake Area mapsheets. Urban mapsheets are ideal if buildings are used. Otherwise, avoid these mapsheets as well, because they provide few hiding places for the defender's units.

After the attacking player selects a home map edge, the defending player sets up his units using the *Hidden Units* rules, p. 77. The defending units may be placed on any hex anywhere on the map, except for Clear and Paved hexes. Additionally, the defending player may set minefields (see p. 80). For each BattleMech or unit in his force, the defender may set one single-hex conventional minefield. For example, if the defender's force consists of a single four-Mech lance or a single four-tank armor lance, he can set four minefields.

### Force Composition

Set the attacking force at twice the size of the defending force. For example, if the defending player controls a single lance, the attacking player uses two lances. Players may use any size forces they wish, as long as the attacker's force is twice the size of the defender's.

If using the BV system, the point value of the attacking force should be double that of the defending force.

### Victory Conditions

The scenario ends when all of one player's units have been destroyed or retreated off the map. The player whose forces control the map or simply survive at the end wins the scenario.

When using the point system, standard rules for victory conditions apply.

### HOLD THE LINE

In a hold-the-line scenario, the defending player must fend off a larger attacking force. The defending units may not intentionally leave the map for any reason.

### Force Composition

Set the attacking player's force at twice the size of the defender's force. For example, if the defending player controls a single lance, the attacking player may use two lances. Players may use any size forces they wish, as long as the attacker's force is twice the size of the defender's. Set the experience levels of the defending player's forces at one level higher than those of the attacker's forces. For example, if the attacking force consists of Regular units, the defender uses Veteran units.

If you are using the BV system, the point value of the defending force equals that of the attacking force, though the defending force must be only half as large as the attacking force. In addition, each unit receives a 1-point improvement in Piloting and Gunnery Skills at no cost in points, rather than the experience-level increase.

### Victory Conditions

The scenario ends when all the units on one side have been destroyed or retreated off the map.

If the defenders destroy a number of opposing units equal to the number of defending units that started the scenario (or more), the defending player wins. For example, if the defending player begins with a single lance (four units), he can claim victory if he manages to destroy four or more attacking units.

# CREATING SCENARIOS

In all other cases, the player whose forces survive or control the map at the scenario's end wins.

If you are using the point system, standard rules for determining victory apply.

## EXTRACTION

In an extraction scenario, the attacking player attempts to extract a target, such as a secret weapon, an important diplomat, or a computer memory core, from behind the defender's lines.

After the players roll dice and select their home map edges, the attacker secretly chooses a target hex for the extraction. The target hex must be within four hex rows of the defender's home edge and cannot be within four hexes of any other map edge. The attacker then writes down the target hex's number and mapsheet name on a slip of paper, which he folds and gives to a neutral party for safekeeping (or the defending player can simply put the paper in his pocket without looking at it).

The attacking player can reveal the target hex to the defender during any End Phase. Any attacking unit can pick up the extraction target by occupying the target hex during an End Phase. Additionally, a unit that retrieves the target can pass it to any friendly unit in the same hex or an adjacent hex during any End Phase.

If a unit carrying the extraction target is destroyed, place the slip of paper in the hex previously occupied by the unit. Any unit in play can retrieve the target by occupying the target hex during any End Phase.

## Force Composition

Both sides start with an equal number of units. If using the BV system, each side should be worth an equal number of points.

## Victory Conditions

If the attacker can move a unit carrying the extraction target off his home map edge, he wins the scenario. Otherwise, the defender wins.

When using the BV system, victory is determined as follows. The defender scores points normally. However, the attacker scores only the point value for each opposing 'Mech he destroys (instead of twice their point value, as normal). The attacker loses points normally for each of his 'Mechs that the defender destroys. If the attacking player manages to move the extraction target off his home map edge, he scores points equal to the total points used to buy forces for his side in the scenario.

## BREAKTHROUGH

In a breakthrough scenario, the attacking player's forces have become trapped behind enemy lines. To reach safety, the units must cross the map and break through the defender's forces.

Use one more mapsheet than the standard one map for every four units (see *Selecting Mapsheets*, p. 100). For example, if eight 'Mechs will be in play, use three mapsheets rather

than two. If you have fewer than the needed number of mapsheets, simply use all available mapsheets. Place the mapsheets in a single, long row with their short edges touching.

Next, both players roll 2D6. The player who achieves the higher result may choose to play the defender or the attacker. The attacker then chooses one of the narrow edges of the map as the place from which his forces will enter. The attacker's home edge is the one opposite the entry edge. (The attacker's objective is to exit his forces at his home map edge.)

The defender may set up his forces in any hexes on the map. Additionally, he may position up to half of his units (round down) using the *Hidden Units* rules, p. 77.

## Force Composition

Both sides should have the same number of units. If you are using the BV system, each side should be worth the same number of points.

## BREAKTHROUGH VICTORY POINTS TABLE

### Attacker

- 2 points for each attacking unit that safely exits at home edge
- 1 point for each defending unit destroyed

### Defender

- 3 points for each attacking unit destroyed or crippled
- 2 points for each attacking unit forced to retreat off map

## Victory Conditions

The scenario ends when all the defending units have been destroyed or retreated off the map, or when all attacking units have retreated, been destroyed or been *crippled*. For the purposes of this type of scenario, units become crippled when they lose one or more legs or their gyros are destroyed. Attacking units may intentionally exit the map only at their home edge; a unit exiting from any other edge has retreated.

If all the attacking units survive and exit at their home edge, the attacking player wins a Decisive victory. If all the attacking forces are destroyed or crippled, or none exit at their home edge, the defending player wins a Decisive victory.

If the players meet neither of these conditions, consult the Breakthrough Victory Points Table to determine each player's Victory Points. The player with the most points wins a Marginal victory. If both players score the same number of Victory Points, the scenario ends in a Draw.

If players are using the BV system to buy their forces, Victory Points are allocated somewhat differently. The defender scores points normally, though he gains only half the listed points for units "destroyed" by being forced off the map. The attacker scores the unmodified point value for destroying opposing 'Mechs, instead of twice their point value. He also scores the unmodified point value for each attacking unit that exits the map via the attacker's home map edge. The attacker



loses points normally for any of his own 'Mechs that the defender destroys. Determine the level of victory as normal, based on each side's final score.

## THE CHASE

In a chase scenario, the attacker's forces must race across the map to reach their DropShip before a larger force of pursuing defenders can reach them. Chase scenarios use the same rules as breakthrough scenarios, with the following exceptions.

The defending player does not deploy his forces until Turn 2. During Turn 1, attacking units may enter and move unopposed per standard rules. The defending units enter during the Movement Phase of Turn 2, from the same map edge as the attacking units.

## Force Composition

Set the defender's force at twice the size of the attacking force. For example, if the attackers form a single lance, the defending force should contain two lances. Under the BV system, the defending force should be worth twice the point value of the attacker's force.

## SELECTING MAPSHEETS

After selecting a scenario type, determine the terrain for the scenario by selecting mapsheets. Certain scenarios require specific types of mapsheets according to their descriptions. In most scenarios, however, players can simply select whichever mapsheets they like or make dice rolls and consult the appropriate mapsheet tables to randomly select mapsheets.

Before selecting mapsheets, determine how many mapsheets you want to use. For most *BattleTech* play, an appropriate ratio is one mapsheet for every four 'Mechs or units. For example, a scenario that pits one lance of attackers against one lance of defenders (eight 'Mechs total) will work best with two mapsheets. A scenario that pits one company of attackers against a company of defenders (twenty-four total 'Mechs) will work best with six mapsheets. Different scenarios may work best with other mapsheet/unit ratios, so check the scenario-type description.

## USING THE MAPSHEET TABLES

Players may use one of two groups of mapsheet tables to randomly select mapsheets. When using the Terrain-Specific Mapsheet Tables, one player rolls 1D6. The result indicates which terrain table is used. For example, on a result of 1, use the Flatlands Terrain Table; on a result of 2, the Hill Terrain Table; and so on. (Alternatively, the players may simply select a specific terrain and skip this step.) Note that the Urban terrain type is set off from the others. Generally, urban terrain is only suitable for scenarios involving buildings, so players may simply select this terrain when appropriate.

Next, select mapsheets from the appropriate table by rolling 1D6. If using two mapsheets, roll twice; if using four mapsheets, roll four times; and so on.

When using the Random Mapsheet Tables, make two 1D6 rolls for each mapsheet. The first roll indicates the specific Random Mapsheet Table from which the mapsheet is selected. For example, on a result of 1, use Random Mapsheet Table 1. The second roll indicates which map from the table is used.

All of the mapsheet tables assume that players possess at least one copy each of *BattleTech Map Sets 2-5*, *BattleForce 2*, and *BattlePack: Fourth Succession War*. (For easy reference, each mapsheet name is followed by an abbreviation of the map set or boxed game that contains the mapsheet.) If any roll result indicates a mapsheet that is unavailable, simply repeat the roll.

## TERRAIN-SPECIFIC MAPSHEET TABLES

**Table 1: Flatlands Terrain**

**1D6 Mapsheet**

- 1 Open Terrain #1 (MS5)
- 2 Open Terrain #2 (MS5)
- 3 Desert Hills (MS2)
- 4 City Ruins (MS2)
- 5 City Street Grid/Park #1 (MS4)
- 6 City Street Grid/Park #2 (MS4)

**Table 2: Hill Terrain**

**1D6 Mapsheet**

- 1 Desert Hills (MS2)
- 2 Rolling Hills #1 (MS3)
- 3 Rolling Hills #2 (MS3)
- 4 City (Hills/Residential) #1 (MS3)
- 5 City (Hills/Residential) #2 (MS3)
- 6 *BattleForce* Map (BF2)

**Table 3: Mountain Terrain**

**1D6 Mapsheet**

- 1 Mountain Lake (MS2)
- 2 River Valley (MS2)
- 3 Desert Mountain #1 (MS3)
- 4 Desert Mountain #2 (MS3)
- 5 Large Mountain #1 (MS5)
- 6 Large Mountain #2 (MS5)

**Table 4: Badlands Terrain**

**1D6 Mapsheet**

- 1 Desert Sinkhole #1 (MS3)
- 2 Desert Sinkhole #2 (MS3)
- 3 Moonscape #1 (MS5)
- 4 Moonscape #2 (MS5)
- 5 Desert Mountain #1 (MS3)
- 6 Desert Mountain #2 (MS3)

**Table 5: Wetlands Terrain**

**1D6 Mapsheet**

- 1 Scattered Woods (MS2)
- 2 Lake Area (MS2)
- 3 Large Lakes #1 (MS4)
- 4 Large Lakes #2 (MS4)
- 5 River Delta/Drainage Basin #1 (MS4)
- 6 River Delta/Drainage Basin #2 (MS4)

**Table 6: Wooded Terrain**

**1D6 Mapsheet**

- 1 Scattered Woods (MS2)
- 2 *BattleTech* Map (BT, MS2)
- 3 Woodland (BP)
- 4 Rolling Hills #1 (MS3)
- 5 Heavy Forest #1 (MS4)
- 6 Heavy Forest #2 (MS4)

**Urban Terrain Table**

**1D6 Mapsheet**

- 1 City Ruins (MS2)
- 2 *CityTech* Map (CT, MS2)
- 3 City (Hills/Residential) #1 (MS3)
- 4 City (Hills/Residential) #2 (MS3)
- 5 City Street Grid/Park #1 (MS4)
- 6 City Street Grid/Park #2 (MS4)

## RANDOM MAPSHEET TABLES

**Table 1**

**1D6 Mapsheet**

- 1 Scattered Woods (MS2)
- 2 Desert Hills (MS2)
- 3 City Ruins (MS2)
- 4 Mountain Lake (MS2)
- 5 *BattleTech* Map (BT, MS2)
- 6 *CityTech* Map (CT, MS2)

**Table 2**

**1D6 Mapsheet**

- 1 River Valley (MS2)
- 2 Lake Area (MS2)
- 3 Desert Mountain #1 (MS3)
- 4 Desert Mountain #2 (MS3)
- 5 Desert Sinkhole #1 (MS3)
- 6 Desert Sinkhole #2 (MS3)

**Table 3**

**1D6 Mapsheet**

- 1 Rolling Hills #1 (MS3)
- 2 Rolling Hills #2 (MS3)
- 3 City (Hills/Residential) #1 (MS3)
- 4 City (Hills/Residential) #2 (MS3)
- 5 Heavy Forest #1 (MS4)
- 6 Roll both dice again

**Table 4**

**1D6 Mapsheet**

- 1 Heavy Forest #2 (MS4)
- 2 City Street Grid/Park #1 (MS4)
- 3 City Street Grid/Park #2 (MS4)
- 4 Large Lakes #1 (MS4)
- 5 Large Lakes #2 (MS4)
- 6 Roll both dice again

**Table 5**

**1D6 Mapsheet**

- 1 River Delta/Drainage Basin #1 (MS4)
- 2 River Delta/Drainage Basin #2 (MS4)
- 3 Deep Canyon #1 (MS5)
- 4 Deep Canyon #2 (MS5)
- 5 Large Mountain #1 (MS5)
- 6 *BattleForce* Map (BF2)

**Table 6**

**1D6 Mapsheet**

- 1 Large Mountain #2 (MS5)
- 2 Moonscape #1 (MS5)
- 3 Moonscape #2 (MS5)
- 4 Open Terrain #1 (MS5)
- 5 Open Terrain #2 (MS5)
- 6 Woodland (BP)

Abbreviations: MS = Map Set, CT = *CityTech* boxed game, BT = *BattleTech* boxed game, BF2 = *BattleForce 2* boxed game, BP = *BattlePack: Fourth Succession War*

# CREATING SCENARIOS

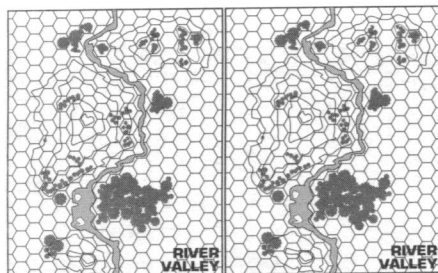

**YES**

## Laying Out the Mapsheets

To begin laying out the mapsheets, the players roll 2D6. The player with the higher result places the first selected mapsheet on the table or floor. The other player then places the next selected mapsheet. The players continue to alternate laying out the remaining mapsheets.

Each mapsheet must be placed with one of its short edges touching the short edge of a mapsheet already placed or

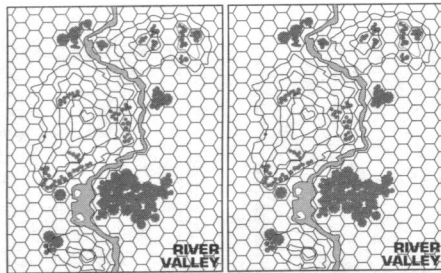

**NO**

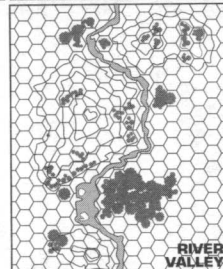

**YES**

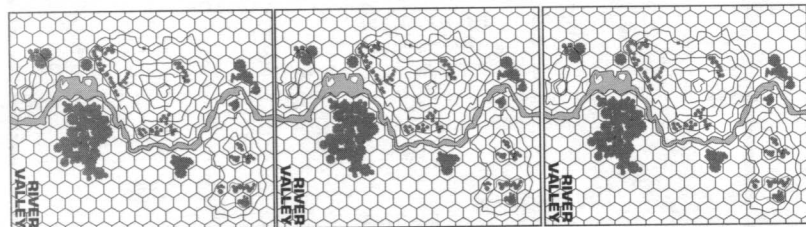

with one of its long edges touching the long edge of a mapsheet already placed. Additionally, the mapsheets must be placed so that they form a single, continuous rectangular or square playing area. Within these and any guidelines provided in the scenario-type description, players may arrange the mapsheets as they see fit.

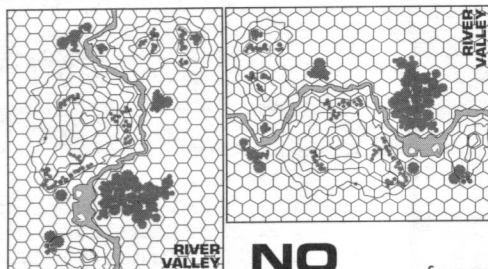

**NO**

## UNIT GENERATION

After selecting the scenario type and mapsheets, generate the units that will take part in the scenario. Players can generate their forces in three ways. First, they may simply assemble any units they wish, perhaps based on the unit descriptions provided in the *BattleTech Field Manuals*. The battlefield strength of a unit is determined by its size, weight class, equipment level and experience level, so players who want to create evenly matched battles should take note of these factors when assembling their forces. Players should also select appropriately sized forces for the chosen scenario.

Alternatively, players may use dice rolls to randomly generate forces. When using this system, players perform three steps: determine their forces' composition, assign BattleMechs and set unit experience levels. This system may not always pro-

duce evenly matched forces, but players may increase the likelihood of generating balanced forces by setting a specific weight class, equipment rating and experience level for both forces before rolling the dice.

The third, and most accurate method of force generation is to purchase forces for each side using Battle Value points. By setting a point level for each side, the players are free to choose any forces they wish within the point limit and do not have to rely on random luck to determine their forces. The Battle Value system is found on page 139 of this book. A list of existing units and their Battle Values appears in the *Maximum Tech* book.

The following tables assist mainly in assigning forces randomly, though players can also use them along with the BV point system. Though the tables used in this system assume that players' forces will consist entirely of BattleMechs and vehicles, these tables can be easily adapted to include infantry and other units.

## FORCE COMPOSITION

Begin assembling forces by determining the size of each force. Often, the specific conditions of a scenario may suggest a particular size. Players may wish to consider available playing time as well—larger engagements may take considerably longer to complete than smaller ones. Most engagements pit two four-'Mech lances against each other, but players are free to use any size forces they desire.

After determining the size of each force, determine its weight class. For lance-sized forces, roll 2D6 and consult the Lance Type section on the Random Weight-Class Tables. For company-sized forces, roll 1D6 and consult the Company Type section of the table. If a company-sized force contains more than three lances, use the Lance Type section to determine the weight class of the extra lances.

In an Inner Sphere force, some or all of the units may consist of conventional forces (vehicles and infantry) instead of BattleMechs. Normally, the players may make this choice, though each unit's type in this regard can also be randomly generated using the Unit Type Table. Keep in mind that using the Unit Type Table will likely result in a high proportion of vehicle units, as vehicles are far more common than BattleMechs in Inner Sphere armies. Clan units consist of 'Mechs and battle armor unless a scenario specifically calls for other types of forces or players are using the point system.

After determining the weight classes of the lance(s) or Star(s) in each force, use the Lance or Star 'Mech/Weight Composition Table to determine the weight classes of the BattleMechs in each lance or Star.

**Clans:** To reflect the unique configuration of Clan forces, use the following guidelines. For Star-sized forces, roll 2D6 and consult the Star Type section on the Random Weight-Class Tables. A result of 12 indicates a Nova unit, consisting of a Star of OmniMechs and a Star of Elemental battle armor. In this case, roll again to determine the weight class of the 'Mechs in the unit, rerolling a result of 2 or 12. Note that Nova units must consist of OmniMechs, so second-line units should reroll Nova results. For Binary and Trinary-sized forces, roll 2D6 and consult the Random Binary/Trinary Type Table.

**ComStar:** The table on p. 104 provides weight classes and compositions for standard Inner Sphere and Clan forces. For ComStar forces (which operate in formations of six), use the Inner Sphere tables modified as follows: for a 6-'Mech Level II unit, start with a lance and add one additional unit of the heaviest and lightest weight classes. For example, a Lance Type roll result of 1 on the Medium Lance Composition Table normally results in 1 Light, 2 Medium, and 1 Heavy 'Mech. A ComStar Level II formation would add an additional Light and an additional Heavy 'Mech to this configuration.

## Bidding

When playing a game involving Clan forces on both sides, the element of *batchall* can be added to the force selection process. First, the players set the size of the defending force. Then, starting with the number of units that would normally be allowed for the attacker in the scenario being played, the play-

ers take turns bidding away units from the attacking force to determine which of them will have the honor of being the attacker in the scenario. The lowest bid is the attacker. If neither player is willing to bid away any portion of the attacking force, the attacker is determined randomly.

As long as the attacker bid away some portion of his starting force, he will receive the following bonuses. He may add +1 to the die roll when rolling on the Random Experience Level Table, and he gains a +1 Initiative bonus for the entire scenario, in addition to any other Initiative bonuses to which he may be entitled. If the attacker bid away half or more of his starting force, these bonuses are doubled to 2.

## ASSIGNING 'MECHS

After determining the weight classes of the BattleMechs in each force, use the Random 'Mech Assignment Tables and Random Vehicle Assignment Table to determine the specific unit designs.

To use the random assignment tables, roll 2D6 and cross-reference the result with the appropriate weight class of 'Mech or vehicle.

Though players can use the random assignment

tables to determine the composition of any force, these tables are simplified and only use a fraction of the forces and factions available in the game. To create forces using a wider range of 'Mechs, players may use the Random 'Mech Assignment Table from the appropriate *BattleTech Field Manual*, or use the BV system to choose the forces they prefer (see p. 139).

## RANDOM WEIGHT-CLASS TABLES

### Unit Type

#### 1D6 Result

1-4

5-6

### Unit Type

Conventional

BattleMech

### Random Lance Type

#### 2D6 Result

2-4

5-7

8-9

10-12

### Weight Class

Light

Medium

Heavy

Assault

### Random Star Type

#### 2D6 Result

2

3-6

7-8

9-10

11

12

### Weight Class

Elemental

Light

Medium

Heavy

Assault

Nova (Roll again for weight class)

### Random Company Type

#### 1D6 Result

1

2

3

4

5

6

### Lance Weight Classes

1 Light, 2 Medium

1 Light, 1 Medium, 1 Heavy

2 Medium, 1 Heavy

1 Light, 2 Heavy

3 Heavy

2 Heavy, 1 Assault

## RANDOM BINARY/TRINARY TYPE

### 2D6 Result

2-4

5-6

7

8

9

10-11

12

### Star Weight Classes (Binary)

2 Light

2 Medium

1 Light, 1 Medium

1 Medium, 1 Heavy

1 Heavy, 1 Assault

2 Heavy

Supernova Binary (Roll again for weight classes)

### Star Weight Classes (Trinary)

3 Light

1 Light, 1 Medium, 1 Heavy

2 Light, 1 Heavy

1 Light, 1 Heavy, 1 Assault

2 Heavy, 1 Assault

1 Medium, 1 Heavy, 1 Assault

Supernova Trinary (Roll again for weight classes)

# CREATING SCENARIOS



## LANCE 'MECH/WEIGHT COMPOSITION TABLE

1D6 Roll	Light Lance	Medium Lance	Heavy Lance	Assault Lance
1	4 Light	1 Light, 2 Med, 1 Heavy	1 Med, 3 Heavy	2 Heavy, 2 Assault
2-3	3 Light, 1 Med	4 Med	4 Heavy	2 Heavy, 2 Assault
4-5	2 Light, 2 Med	3 Med, 1 Heavy	1 Med, 2 Heavy, 1 Assault	1 Heavy, 3 Assault
6	2 Light, 1 Med, 1 Heavy	2 Med, 2 Heavy	3 Heavy, 1 Assault	4 Assault

## STAR 'MECH/WEIGHT COMPOSITION TABLE

1D6 Roll	Light Star	Medium Star	Heavy Star	Assault Star
1	5 Light	1 Light, 4 Med	2 Med, 3 Heavy	1 Med, 2 Heavy, 2 Assault
2-3	4 Light, 1 Med	5 Med	1 Med, 4 Heavy	4 Hvy, 1 Assault
4-5	3 Light, 2 Med	4 Med, 1 Heavy	5 Heavy	3 Hvy, 2 Assault
6	2 Light, 2 Med, 1 Heavy	3 Med, 2 Heavy	1 Med, 3 Hvy, 1 Assault	2 Hvy, 3 Assault

# CREATING SCENARIOS

## RANDOM 'MECH ASSIGNMENT TABLE: INNER SPHERE 1

### Light 'Mechs

2D6	House Kurita	House Liao	House Marik
2	HM-1 Hitman	JA-KL-1532 Jackal	ZPH-1A Tarantula
3	JR7-D Jenner	JR7-D Jenner	ZPH-1A Tarantula
4	OW-1 Owens	RVN-3L Raven	JA-KL-1532 Jackal
5	PNT-10K Panther	UM-R63 UrbanMech	HER-3S Hermes
6	RTX1-OC Raptor	FS9-S Firestarter	SDR-7M Spider
7	RTX1-O Raptor	RVN-3L Raven	HMR-3M Hammer
8	PNT-10K Panther	SDR-5V Spider	HMR-3M Hammer
9	JR7-K Jenner	UM-R63 UrbanMech	JR7-D Jenner
10	SDR-7M Spider	ZPH-1A Tarantula	HER-3S Hermes
11	SDR-9K Venom	JVN-10N Javelin	FNHK-9K Falcon Hawk
12	PNT-9R Panther	UM-R60 UrbanMech	ZPH-1A Tarantula

### Medium 'Mechs

2D6	House Kurita	House Liao	House Marik
2	KTO-20 Kintaro	BJ2-OE Blackjack	FS9-OF Firestarter
3	WFT-1 Wolf Trap	SNK-1V Snake	APL-1M Apollo
4	DMO-1K Daimyo	HUR-WO-R4L Huron Warrior	CDA-3M Cicada
5	SR1-O Strider	VND-3L Vindicator	HER-2S Hermes II
6	BJ2-O Blackjack	DV-7D Dervish	TBT-7M Trebuchet
7	FS9-O Firestarter	VND-3L Vindicator	HER-5S Hermes II
8	SR1-OD Strider	BJ-2 Blackjack	HBK-5M Hunchback
9	KIM-2 Komodo	CLNT-2-3U Clint	HER-5S Hermes II
10	WFT-1 Wolf Trap	SNK-1V Snake	TBT-7M Trebuchet
11	BJ2-OA Blackjack	HUR-WO-R4L Huron Warrior	TR1 Wraith
12	LNX-9C Lynx	BJ2-OE Blackjack	BJ2-OE Blackjack

### Heavy 'Mechs

2D6	House Kurita	House Liao	House Marik
2	DGR-3F Dragon Fire	THR-1L Thunder	ANV-3M Anvil
3	AV1-OA Avatar	ON1-K Orion	WR-DG-02-FC War Dog
4	DRG-5K Grand Dragon	CPLT-C1 Catapult	GLT-5M Guillotine
5	BHKU-O Black Hawk-KU	CTF-3L Cataphract	TMP-3M Tempest
6	DAI-01 Daikyu	CPLT-C3 Catapult	ON1-M Orion
7	DRG-5K Grand Dragon	CTF-3L Cataphract	ON1-M Orion
8	QKD-5K Quickdraw	GHR-5J Grasshopper	CPLT-C1 Catapult
9	CPLT-K2 Catapult	CPLT-C3 Catapult	GLT-5M Guillotine
10	MTR-5K Maelstrom	ANV-3M Anvil	TMP-3M Tempest
11	AV1-O Avatar	GHR-5H Grasshopper	HRC-LS-9000 Hercules
12	NDA-1K No Dachi	WR-DG-02FC War Dog	P1 Perseus

### Assault 'Mechs

2D6	House Kurita	House Liao	House Marik
2	OBK-M10 O-Bakemono	STC-2D Striker	ALB-3U Albatross
3	NG-C3A Naginata	AWS-9M Awesome	CGR-1A1 Charger
4	HTM-27T Hatamoto-chi	MR-V2 Cerberus	T-IT-N10M Grand Titan
5	SD1-O Sunder	AS7-K Atlas	STK-5M Stalker
6	AS7-K Atlas	EMP-6A Emperor	AS7-D Atlas
7	HTM-27T Hatamoto-chi	STK-3F Stalker	AWS-9M Awesome
8	MAL-1R Mauler	STK-5M Stalker	AWS-9M Awesome
9	CRK5003-2 Katana	AS7-K Atlas	AS7-K Atlas
10	CGR-3K Charger	AWS-8Q Awesome	MR-V2 Cerberus
11	SD1-OB Sunder	CP-11-A Cyclops	LGB-7Q Longbow
12	AKU-1X Akuma	T-IT-N10M Grand Titan	GRN-D-01 Grand Crusader

# CREATING SCENARIOS

## RANDOM 'MECH ASSIGNMENT TABLE: INNER SPHERE 2

### Light 'Mechs

2D6	House Davion	House Steiner	ComStar
2	RTX1-O Raptor	NTK-2Q Night Hawk	HSR-400-D Hussar
3	HNT-171 Hornet	WLF-2 Wolfhound	UM-R63 UrbanMech
4	ALM-7D Fireball	BZK-F3 Hollander	THE-N Thorn
5	JVN-10P Javelin	SDR-5V Spider	MON-66 Mongoose
6	WLF-2 Wolfhound	COM-5S Commando	MCY-99 Mercury
7	JVN-10P Javelin	FS9-S Firestarter	MCY-99 Mercury
8	COM-5S Commando	COM-5S Commando	HER-1S Hermes
9	JR7-D Jenner	JVN-10P Javelin	THE-N Thorn
10	DRT-3S Dart	JR7-D Jenner	HSR-200-D Hussar
11	BH-305 Battle Hawk	COM-2D Commando	MON-66 Mongoose
12	SPR-5F Spector	TLN-5W Talon	NXS1-A Nexus

### Medium 'Mechs

2D6	House Davion	House Steiner	ComStar
2	FS9-O Firestarter	END-6Q Enfield	WVE-9N Wyvern
3	ASN-23 Assassin	ENF-5D Enforcer	CLT-2-3U Clint
4	STH-1D Stealth	HCT-5S Hatchetman	STN-3L Sentinel
5	BJ-2 Blackjack	CLNT-2-3U Clint	GRM-R-PR29 Grim Reaper
6	WTH-2 Whitworth	VL-5S Vulcan	CRB-27 Crab
7	ENF-5D Enforcer	HCT-3F Hatchetman	CRB-27 Crab
8	HCT-5S Hatchetman	NGS-4S Nightsky	WVE-5N Wyvern
9	CN9-D Centurion	VL-5S Vulcan	HBK-5N Hunchback
10	NGS-4S Nightsky	CN9-D Centurion	ASN-23 Assassin
11	ENF-5D Enforcer	BSW-X1 Bushwacker	KTO-19 Kintaro
12	SR1-O Strider	STY-3C Starslayer	RJN101-A Rajjin

### Heavy 'Mechs

2D6	House Davion	House Steiner	ComStar
2	FLC-8R Falconer	CTS-6Y Cestus	BL-9-KNT Black Knight
3	MDG-1A Rakshasa	GHR-5J Grasshopper	CHP-3N Champion
4	AXM-1N Axman	CES-3R Caesar	BMB-12D Bombardier
5	BNDR-01A Bandersnatch	GAL-1GLS Gallowglas	BL-6-KNT Black Knight
6	CES-3R Caesar	PTR-4D Penetrator	LNC25-01 Lancelot
7	JM6-DD JagerMech	CES-3R Caesar	GLT-3N Guillotine
8	FLC-8R Falconer	WR-DG-02FC War Dog	FLS-8K Flashman
9	JM6-DD JagerMech	AXM-1N Axman	CHP-1N Champion
10	MDG-1A Rakshasa	GAL-1GLS Gallowglas	EXT-4D Exterminator
11	CTF-3D Cataphract	MTR-5K Maelstrom	ST-8A Shootist
12	PTR-4D Penetrator	DGR-3F Dragon Fire	EXC-B2 Excalibur

### Assault 'Mechs

2D6	House Davion	House Steiner	ComStar
2	DVS-2 Devastator	STC-2C Striker	KGC-001 King Crab
3	CP-11-A Cyclops	STK-5S Stalker	STK-5M Stalker
4	GUN-1ERD Gunslinger	PPR-5S Salamander	CRK-5003-1 Crockett
5	AWS-8Q Awesome	STK-3F Stalker	THG-11E Thug
6	VTR-9K Victor	ZEU-9S Zeus	HGN-732 Highlander
7	VTR-9K Victor	ZEU-9S Zeus	HGN-732 Highlander
8	AS7-S Atlas	BNC-5S Banshee	CRK-5003-1 Crockett
9	VTR-9B Victor	AS7-S Atlas	AS7-K Atlas
10	AS7-K Atlas	BRZ-A3 Berserker	KGC-000 King Crab
11	BNC-5S Banshee	ZEU-6S Zeus	CP-11-A Cyclops
12	LGB-7Q Longbow	EMP-6A Emperor	SPT-N2 Spartan

# CREATING SCENARIOS

## RANDOM 'MECH ASSIGNMENT TABLE: CLANS

### Light 'Mechs

2D6	Jade Falcon	Wolf	Ghost Bear	Smoke Jaguar
2	Vixen	Jenner IIC	Jenner IIC	Peregrine
3	Fire Falcon Prime	Puma A	Dasher C	Koshi A
4	Cougar C	Koshi B	Dasher D	Puma Prime
5	Uller B	Puma B	Puma Prime	Hankyu Prime
6	Fire Falcon A	Dasher A	Dasher B	Koshi B
7	Uller Prime	Puma Prime	Dasher Prime	Hankyu A
8	Cougar Prime	Uller C	Puma A	Koshi Prime
9	Uller A	Puma C	Uller A	Hankyu C
10	Uller D	Puma D	Koshi B	Koshi C
11	Fire Falcon B	Koshi A	Dasher A	Dasher B
12	Baboon	Jenner IIC	Peregrine	Jenner IIC

### Medium 'Mechs

2D6	Jade Falcon	Wolf	Ghost Bear	Smoke Jaguar
2	Hellhound	Hunchback IIC	Black Hawk A	Hunchback IIC
3	Ryoken Prime	Fenris C	Ryoken Prime	Grendel A
4	Fenris A	Phantom Prime	Fenris Prime	Ryoken B
5	Dragonfly A	Fenris D	Dragonfly A	Grendel Prime
6	Black Lanner C	Phantom C	Black Hawk Prime	Black Hawk C
7	Black Lanner Prime	Fenris B	Dragonfly Prime	Ryoken Prime
8	Ryoken B	Fenris Prime	Dragonfly B	Ryoken A
9	Black Hawk A	Ryoken Prime	Ryoken C	Shadow Cat Prime
10	Black Lanner A	Pouncer Prime	Dragonfly D	Grendel D
11	Black Lanner B	Black Hawk Prime	Dragonfly C	Shadow Cat A
12	Hunchback IIC	Pouncer A	Hunchback IIC	Fenris Prime

### Heavy 'Mechs

2D6	Jade Falcon	Wolf	Ghost Bear	Smoke Jaguar
2	Night Gyr D	Linebacker Prime	Grizzly	Cauldron-Born Prime
3	Thor B	Mad Cat D	Loki Prime	Vulture C
4	Loki A	Vulture Prime	Vulture A	Thor Prime
5	Night Gyr Prime	Mad Cat B	Thor A	Mad Cat Prime
6	Thor A	Loki Prime	Mad Cat Prime	Vulture B
7	Loki Prime	Mad Cat Prime	Vulture Prime	Vulture Prime
8	Thor Prime	Mad Cat A	Vulture C	Loki A
9	Thor D	Thor Prime	Thor Prime	Vulture A
10	Night Gyr A	Mad Cat C	Vulture B	Mad Cat C
11	Loki B	Vulture A	Mad Cat A	Thor D
12	Night Gyr C	Galahad	Loki B	Cauldron-Born B

### Assault 'Mechs

2D6	Jade Falcon	Wolf	Ghost Bear	Smoke Jaguar
2	Kraken	Naga Prime	Supernova	Man O' War C
3	Turkina B	Man O' War B	Man O' War Prime	Daishi B
4	Gladiator C	Masakari A	Gladiator B	Kingfisher C
5	Masakari Prime	Gladiator D	Kingfisher Prime	Masakari C
6	Turkina A	Man O' War C	Daishi Prime	Kingfisher Prime
7	Turkina Prime	Man O' War Prime	Gladiator Prime	Masakari Prime
8	Daishi Prime	Gladiator Prime	Masakari B	Daishi Prime
9	Masakari B	Man O' War A	Gladiator A	Masakari A
10	Turkina C	Daishi Prime	Masakari Prime	Daishi A
11	Masakari A	Masakari Prime	Gladiator D	Kingfisher D
12	Man O' War A	Supernova	Kodiak	Behemoth

# CREATING SCENARIOS

## RANDOM VEHICLE ASSIGNMENT TABLE: INNER SPHERE

2D6	Light Vehicle	Medium Vehicle	Heavy Vehicle	Assault Vehicle
2	Yellow Jacket Gunship	Regulator Hovertank	Zhukov Heavy Tank	Alacorn Mk VI Heavy Tank
3	Striker Light Tank	Goblin Medium Tank	Patton Tank	SturmFeur Heavy Tank
4	Harasser Missile Platform	Hetzer Wheeled Assault Gun	Po Heavy Tank	Schrek PPC Carrier
5	Hunter Light Support Tank	Drillson Heavy Hovertank	Manticore Heavy Tank	Partisan Heavy Tank
6	Saladin Assault Hovertank	Maxim Heavy Hover Transport	Pike Support Vehicle	Demolisher Heavy Tank
7	Saracen Medium Hovertank	Vedette Medium Tank	LRM Carrier	Ontos Heavy Tank
8	Scimitar Medium Hovertank	Maxim Heavy Hover Transport	SRM Carrier	Ontos Heavy Tank
9	Pegasus Scout Hovertank	Condor Heavy Hovertank	Bulldog Medium Tank	Schrek PPC Carrier
10	Scorpion Light Tank	Goblin Medium Tank	Von Luckner Heavy Tank	Partisan Heavy Tank
11	J. Edgar Light Hovertank	Drillson Heavy Hovertank	Rommel Tank	Behemoth Heavy Tank
12	Cavalry Attack Helicopter	Fulcrum Heavy Hovertank	Tokugawa Heavy Tank	Challenger X MBT

## RANDOM SKILLS TABLE (EXPANDED)

1D6 (Green)	1D6 (Regular)	1D6 (Veteran)	1D6 (Elite)	Piloting	Gunnery
0 or less	—	—	—	7	7
1	—	—	—	7	6
2-3	0 or less	—	—	6	5
4-5	1-2	0 or less	—	6	4
6-7	3-4	1-2	0 or less	5	4
8	5-6	3-4	1-2	4	3
—	7-8	5-6	3-4	3	2
—	—	7-8	5-6	2	1
—	—	—	7-8	1	0

### EXPERIENCE LEVEL AND SKILLS

After determining the 'Mech designs employed by each force, the players determine the experience levels (Green, Regular, Veteran or Elite) of their forces. If the players are using elements of specific units, they can consult the appropriate *Field Manual*. Alternatively, the players may simply set any experience levels they wish, or use the Random Experience Level Table. (Players can help ensure a balanced battle by setting the same level for both forces.)

After determining his forces' experience level, each player determines the Gunnery and Piloting Skills of his MechWarriors. If the players agree, they can simply assign all MechWarriors the standard starting skill levels (see p. 14). Alternatively, each player may use the Random Skills Table to randomly determine the skill levels of his MechWarriors. To do so, each player makes two 1D6 rolls for each MechWarrior and vehicle crew in his force. (Add 2 to each roll result for Clan MechWarriors; subtract 2 from the roll result for Clan vehicle crews.) The first die roll result determines the MechWarrior's Piloting Skill; the second, the MechWarrior's Gunnery Skill.

### RANDOM EXPERIENCE LEVEL TABLE

2D6 Roll	Experience Level
2-5	Green
6-9	Regular
10-11	Veteran
12	Elite

**Battle Values:** The Battle Value system, p. 139, allows players to simply assign the desired skill levels to their units by spending a specified number of points.

### FINISHING TOUCHES

If all players agree, they can fine-tune their units by shifting 'Mechs between lances and Stars after they have generated all their 'Mechs and skills for all their MechWarriors, though MechWarriors may not be removed from their assigned

'Mechs. Fine-tuning a force in this manner enables a player to group 'Mechs with similar movement capabilities in lances and arrange effective command, control and communication (C<sup>3</sup>) networks (see p. 124).

### Commanders

In some cases, players may wish to designate lance, company, battalion or regiment commanders within their forces. Usually, the MechWarrior with the highest skills and/or heaviest BattleMech in each unit is the unit's commander, but players may use any criteria when designating commanders. After selecting commanders, each player should identify command units as such on those units' record sheets.

## CONSTRUCTION

*BattleTech* players may want to design BattleMechs and vehicles to fit certain specifications or to serve specific purposes. This chapter provides rules for constructing such custom machines, including comprehensive Clan and Inner Sphere Weapons and Equipment Tables. Detailed descriptions of the weapons and equipment used in BattleMech and vehicle construction appear in the *Equipment* section, p. 122.

Machines designed with these rules are essentially "factory-built" models, as opposed to custom variants or retrofits. Rules for making custom modifications to 'Mechs and vehicles, including the mixing of Clan and Inner Sphere technology on a chassis, can be found in the *Scavenging and Repair* rules, page 82.

### BATTLEMECH CONSTRUCTION

The following system makes it possible for players to construct unique BattleMechs using any legal mix of speed, armor and weapons they desire. These designs can then be pitted against other custom and standard machines on the battlefield.

In order to design a BattleMech, a player will need a piece of scratch paper, a pen, the appropriate Weapons and Equipment Table, and a blank BattleMech Record Sheet.

During construction, you must keep track of two primary factors: tonnage and critical space. Each 'Mech has a limited amount of each available, so these factors will govern how much and what kind of equipment you can mount in your 'Mech.

#### Tonnage

BattleMechs weigh between 20 and 100 tons (increasing in increments of 5 tons). Within these limits, the player may choose any tonnage. Record the BattleMech tonnage at the top of the sheet of scratch paper. The total weight of the BattleMech's engine, weapons, armor and other components may not exceed or fall short of this amount. As you add components to the 'Mech, keep a running total of the tonnage remaining for your 'Mech.

#### Critical Space

Each record sheet provides a Critical Hit Table describing every part of the BattleMech's body. Certain sections of this table are already filled in, because certain components and equipment must be located in specific body locations. As he chooses the 'Mech's various design elements, the player assigns the BattleMech's additional heat sinks, jump jets and weapons to different parts of its body and places them in a slot for that location on the Critical Hit Table.

Remember that certain items take up more than one critical slot on the table. These items should be specially noted on the tables, because a critical hit to any one of these slots destroys the entire component or piece of equipment, and further hits to other slots assigned to the same item have no further effect (see sample record sheet, p. 114).

The Critical Space Table summarizes the number of open critical slots (critical slots not automatically assigned to specific equipment in every 'Mech, such as the engine, gyro, life support and sensors) in each location. You can refer to these numbers as you design your 'Mech to make sure you do not exceed the space limitations of each location.

**Arm Actuators:** To open up more slots, a player may choose to remove actuators from his design's arms. Hand actuators may be removed in this fashion, and lower arm actuators can be removed if the hand is also removed from that arm. BattleMechs lacking these actuators suffer penalties when making certain physical attacks, as explained in *Combat*, p. 39.

#### CRITICAL SPACE TABLE

Location	Open Critical Slots
Head	1
Center Torso	2
Right Torso	12
Left Torso	12
Right Arm	8*
Left Arm	8*
Right Leg	2
Left Leg	2

\* Additional space can be made in the arms by removing actuators. Each arm can have as many as 10 open critical slots. Also, four-legged (quad) 'Mechs (see p. 75) have only 2 slots open in these locations.

#### DESIGN THE CHASSIS

This stage creates the 'Mech's basic framework, or chassis. To start the construction process, the player must make certain basic choices about his 'Mech. These will determine what kind of 'Mech it is, and they will restrict the designer's access to certain equipment. The choices to be made are the 'Mech's technology

base and its tonnage. These choices will, in turn, determine the internal structure's mass. Finally, every 'Mech must have a cockpit, which is also added at this stage.

#### Determine Technology Base

BattleMechs can be constructed using one of two available technology bases, Inner Sphere or Clan. BattleMechs constructed using Clan technology tend to be faster and more powerful than their Inner Sphere counterparts. The player must also choose whether the BattleMech that he is designing is an OmniMech or a standard BattleMech. (See *Outfitting an OmniMech*, p. 120, for more information on OmniMechs.)

Based on the chosen technology base, the player must be sure to use the appropriate Weapons and Equipment Table for his BattleMech. Inner Sphere 'Mechs may only use Inner Sphere equipment, while Clan 'Mechs may only use Clan equipment.

## INTERNAL STRUCTURE TABLE

Total 'Mech Tonnage	Tons of Internal Structure						Maximum Armor Factor
	Standard Structure	Endo Steel	Center Torso Boxes	L/R Torso Boxes	Each Arm Boxes	Each Leg Boxes	
20	2.0	1.0	6	5	3	4	69
25	2.5	1.5	8	6	4	6	89
30	3.0	1.5	10	7	5	7	105
35	3.5	2.0	11	8	6	8	119
40	4.0	2.0	12	10	6	10	137
45	4.5	2.5	14	11	7	11	153
50	5.0	2.5	16	12	8	12	169
55	5.5	3.0	18	13	9	13	185
60	6.0	3.0	20	14	10	14	201
65	6.5	3.5	21	15	10	15	211
70	7.0	3.5	22	15	11	15	217
75	7.5	4.0	23	16	12	16	231
80	8.0	4.0	25	17	13	17	247
85	8.5	4.5	27	18	14	18	263
90	9.0	4.5	29	19	15	19	279
95	9.5	5.0	30	20	16	20	293
100	10.0	5.0	31	21	17	21	307

Blaine is designing a new BattleMech. He decides it will be a Medium city fighter with a variety of weapons and good armor protection. He decides his 'Mech will be an Inner Sphere design, and will not be an OmniMech. He also has a name in mind: the Wyvern.

### Choose Tonnage

BattleMechs weigh between 20 and 100 tons (measured in 5-ton increments). Within these limits, the player may choose any tonnage. Record the BattleMech tonnage at the top of the sheet of scratch paper. The total weight of the BattleMech's engine, weapons, armor and other components may not exceed or fall short of this amount.

*Medium BattleMechs weigh between 40 and 55 tons. Blaine chooses to make his Wyvern a 45-ton 'Mech.*

### Allocate Tonnage for Internal Structure

The internal structure takes up 10 percent of a BattleMech's total weight. The Internal Structure Table shows the number of tons of internal structure required by every BattleMech of a given weight, and the number and allocation of the BattleMech's internal structure boxes. The head's internal structure is not listed on the table, because all BattleMech heads take up 3 internal structure boxes.

Mark out any excess boxes on the Internal Structure Diagram of the record sheet to indicate the number of boxes that make up each hit location.

Players may also choose to build their 'Mechs using endo steel technology. If the 'Mech will use endo steel in its construc-

tion, reduce the internal structure weight requirement by half. For ease of reference, the weights of both standard and endo steel structures are listed on the Internal Structure Table. (See also *Endo Steel Internal Structure*, p. 127 in *Equipment*.)

**Criticals:** Note that players who choose endo steel technology for an Inner Sphere 'Mech must assign endo steel to 14 critical slots on the BattleMech's Critical Hit Table. Players who add endo steel to a Clan BattleMech must assign endo steel to 7 critical slots on the BattleMech's Critical Hit Table.

*The Internal Structure Table shows that a 45-ton 'Mech has 4.5 tons of internal structure. Because Blaine wants this design to have lots of weapons and armor, he decides to give the Wyvern endo steel internal structure, which reduces the weight of the internal structure to 2.5 tons. He has 42.5 tons left (45 - 2.5 = 42.5). He will need to allocate 14 critical slots to the endo steel, but he will wait until later before he decides exactly where those spaces will be.*

### Add Cockpit

Every BattleMech must have a cockpit, which contains the MechWarrior's control station, life-support system and electronic sensors. All BattleMech cockpits weigh 3 tons, regardless of the BattleMech's overall tonnage. Subtract 3 tons from the BattleMech's remaining tonnage.

*Every 'Mech must have a cockpit, and the Wyvern is no exception. Blaine has 39.5 tons left (42.5 - 3 = 39.5).*

## FUSION ENGINE TABLE

Engine Engine Rating	Std. Engine Tonnage	XL Tonnage
10	0.5	0.5
15	0.5	0.5
20	0.5	0.5
25	0.5	0.5
30	1.0	0.5
35	1.0	0.5
40	1.0	0.5
45	1.0	0.5
50	1.5	1.0
55	1.5	1.0
60	1.5	1.0
65	2.0	1.0
70	2.0	1.0
75	2.0	1.0
80	2.5	1.5
85	2.5	1.5
90	3.0	1.5
95	3.0	1.5
100	3.0	1.5
105	3.5	2.0
110	3.5	2.0
115	4.0	2.0
120	4.0	2.0
125	4.0	2.0
130	4.5	2.5
135	4.5	2.5
140	5.0	2.5
145	5.0	2.5
150	5.5	3.0
155	5.5	3.0
160	6.0	3.0
165	6.0	3.0
170	6.0	3.0
175	7.0	3.5
180	7.0	3.5
185	7.5	4.0
190	7.5	4.0
195	8.0	4.0
200	8.5	4.5
205	8.5	4.5
210	9.0	4.5
215	9.5	5.0
220	10.0	5.0
225	10.0	5.0
230	10.5	5.5
235	11.0	5.5
240	11.5	6.0
245	12.0	6.0
250	12.5	6.5
255	13.0	6.5
260	13.5	7.0
265	14.0	7.0
270	14.5	7.5

Engine Engine Rating	Std. Engine Tonnage	XL Tonnage
275	15.5	8.0
280	16.0	8.0
285	16.5	8.5
290	17.5	9.0
295	18.0	9.0
300	19.0	9.5
305	19.5	10.0
310	20.5	10.5
315	21.5	11.0
320	22.5	11.5
325	23.5	12.0
330	24.5	12.5
335	25.5	13.0
340	27.0	13.5
345	28.5	14.5
350	29.5	15.0
355	31.5	16.0
360	33.0	16.5
365	34.5	17.5
370	36.5	18.5
375	38.5	19.5
380	41.0	20.5
385	43.5	22.0
390	46.0	23.0
395	49.0	24.5
400	52.5	26.5

### ADD OTHER EQUIPMENT

After the 'Mech's framework is designed, the player must choose and add the remaining elements of the BattleMech. These elements include the engine, gyroscope, armor, jump jets and weapons and other equipment.

These additional elements need not be added in any particular order, because the design process often involves a bit of give-and-take as the 'Mech nears completion. For example, you may not know how many heat sinks you want to add until after you have chosen the 'Mech's weapons. Likewise, some players always assign armor first (usually applying the maximum amount the unit can carry), while others wait to see how much tonnage is left after adding weapons.

### Determine Engine Rating

Each BattleMech carries one fusion plant to power its movement and other systems. The relative output of this power plant is measured by its engine rating. A BattleMech's engine rating is determined by the 'Mech's weight and desired speed. Multiply the BattleMech's tonnage by the desired Walking MP. The result is the 'Mech's engine rating. Note that the 'Mech's Running MP can also be calculated at this time by multiplying the Walking MP by 1.5 and rounding up.

$$\begin{aligned} \text{Tonnage} \times \text{Desired Walking MP} &= \text{Engine Rating} \\ \text{Walking MP} \times 1.5 &= \text{Running MP} \end{aligned}$$

The Fusion Engine Table, p. 111, lists the tonnage taken up by engines of various ratings. Note that a player may select an Extralight (XL) version of an engine rather than the standard version. XL engines weigh half as much as their standard counterparts, rounded up to the nearest half ton. For ease of reference, the weights of both standard and XL engines are listed on the Fusion Engine Table. (See also *XL Engines*, p. 134 in *Equipment*.)

**Criticals:** If you choose an XL engine, you will need to assign extra critical slots for the engine in the right and left torso. An Inner Sphere XL engine fills 3 critical slots in both the right and left torso locations, while the Clan version fills only 2 critical slots in those locations.

*Because the Wyvern is intended to fight in the confines of an urban jungle, high speed is not a concern. Blaine decides to give the 'Mech a Walking MP rating of 4. This means the Wyvern has an engine rating of 180 ( $4 \times 45 = 180$ ). Looking at the Fusion Engine Table, a standard 180-rated engine weighs 7 tons. Subtracting the weight of the engine leaves Blaine with 32.5 tons ( $39.5 - 7 = 32.5$ ). The Running MP of the Wyvern is 6 ( $4 \times 1.5 = 6$ ).*

## Add Gyroscope

Every BattleMech must be equipped with a powerful gyroscope to keep it upright and able to move. The exact size of a BattleMech's gyroscope depends on its engine rating. Divide the BattleMech's engine rating by 100 (rounding up). The resulting number is the weight of the gyroscope in tons. Subtract this figure from the tonnage remaining.

*The Wyvern's engine rating of 180 means that it needs a 2-ton gyroscope ( $180 \div 100 = 1.8$ , rounded up to 2). This leaves Blaine with 30.5 tons ( $32.5 - 2 = 30.5$ ).*

## JUMP JET WEIGHT TABLE

Mech Tonnage	Jump Jet Weight
20-55	.5 tons/Jump MP
60-85	1 ton/Jump MP
90-100	2 tons/Jump MP

## Determine Jump Capability

BattleMechs may be equipped with jump jets in their legs and/or backs to allow jump movement. The weight of the jump jets depends on the weight of the BattleMech and the Jumping MP desired, as shown in the Jump Jet Weight Table.

Each jump jet gives the BattleMech one Jumping Movement Point, so that a BattleMech with four jump jets would have a Jumping MP of 4. A BattleMech cannot be constructed with Jumping MP greater than its Walking MP.

**Criticals:** Assign one critical slot in either a leg or torso location to each jump jet's exhaust port.

*In order to move easily through a landscape filled with buildings, the Wyvern will need jump jets. Looking at the Jump Jet Weight Table, Blaine sees that each Jump MP will cost him half a ton. He decides to give his 'Mech the maximum Jumping MP of 4, at a cost of 2 tons. This leaves him with 28.5 tons ( $30.5 - 2 = 28.5$ ). Each jump jet exhaust port requires a critical slot. Blaine places one in each leg, leaving one slot open in each leg, and places one each in the right and left torso, leaving 11 critical slots open in those locations.*

## Add Heat Sinks

Heat sinks dissipate heat produced by movement, weapons fire and other actions. Every BattleMech comes equipped with 10 heat sinks as part of the design that do not take up tonnage (but they may take up critical slots, see *Criticals*, below). However, most BattleMechs need more than 10 heat sinks to get rid of excess heat efficiently. Extra heat sinks can be acquired at the cost of 1 ton per heat sink.

Players may choose either double or standard heat sinks (see *Heat Sinks*, p. 128 in *Equipment*). A BattleMech may only carry one type of heat sink, either standard or double heat sinks, but not a mixture of both. If the player chooses to equip the 'Mech with double heat sinks, the 10 heat sinks built into the 'Mech's design are double sinks. If standard heat sinks are selected, the 10 heat sinks that come with the 'Mech are standard heat sinks.

**Criticals:** A number of heat sinks equal to the engine rating divided by 25 (round down) are assumed to be an integral part of the engine. These heat sinks are only destroyed if the engine is totally destroyed, and so cannot take critical hits. For example, if the player adds 5 heat sinks (for a total of 15) to a BattleMech carrying an engine rated at 210, 8 of these sinks ( $210 \div 25 = 8.4$ , rounded down to 8) are considered integral to the engine and do not have to be assigned to critical slots. The other 7 [ $10$  (original equipment) +  $5$  (extra) -  $8$  (unallocated)] must be assigned to critical slots. Each standard heat sink fills one critical slot. Clan double heat sinks fill two critical slots each, while Inner Sphere double heat sinks fill three slots each. Note that this allocation of critical slots applies only to those heat sinks that are not integral to the engine.

*The Wyvern is intended to have a good selection of weapons, but Blaine knows he will not be able to add very many on a Medium 'Mech. He figures adding two additional heat sinks should be sufficient for the 'Mech's needs, at a cost of 2 tons. Subtracting the weight of the heat sinks leaves Blaine with 26.5 tons ( $28.5 - 2 = 26.5$ ).*

*Next Blaine figures out the number of heat sinks that must be assigned to critical slots. The engine rating divided by 25 rounded down equals 7 ( $180 \div 25 = 7.2$ ). With 12 heat sinks total, he will need to assign 5 of them to critical slots ( $12 - 7 = 5$ ). Because the 'Mech needs to assign so many heat sinks to critical*

spaces, Blaine decides not to use double heat sinks since they might not fit. He places one heat sink in the open slot in the head and two heat sinks in each side torso location. This fills all open critical slots in the head and leaves 9 open in the right and left torso.

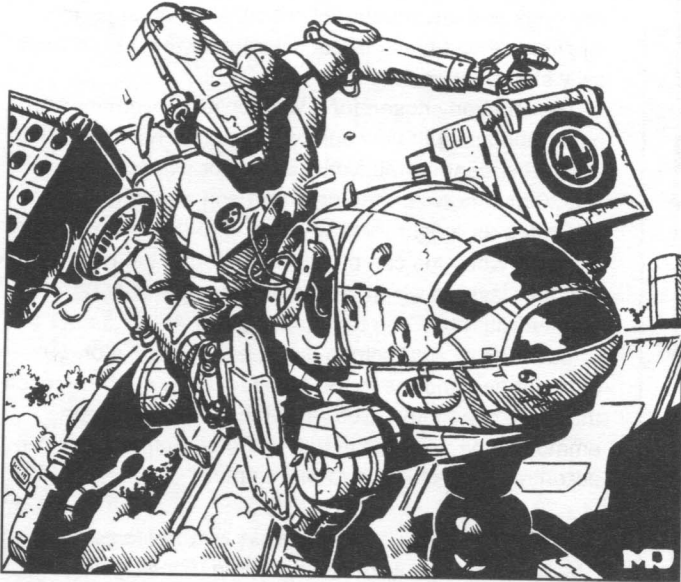

## Add Armor

Armor helps protect the BattleMech's internal structure and critical components. Armor can be standard or ferro-fibrous. For each ton of standard armor selected, the BattleMech has 16 Armor Points. Ferro-fibrous armor gives the 'Mech more Armor Points per ton (see *Ferro-Fibrous Armor*, p. 127 in *Equipment*).

Determine the total tonnage of armor the BattleMech will carry. Armor must be added in 1/2- or 1-ton increments. Multiply the tonnage of armor chosen by 16 to find the 'Mech's total Armor Points. If the 'Mech has ferro-fibrous armor, this total is further multiplied, by 1.12 for Inner Sphere 'Mechs or 1.2 for Clan 'Mechs, and rounded normally (up on .5) to find the total ferro-fibrous Armor Points.

Divide the total Armor Points carried by the BattleMech among the eleven different locations shown on the Armor Diagram. The player chooses the exact number of Armor Points used to protect a given area, but the number of Armor Points in a single location may not exceed twice the number of Internal Structure boxes in that location, regardless of whether the armor is standard or ferro-fibrous. For example, if a BattleMech has 10 Internal Structure boxes in its left arm, then the left arm can carry no more than 20 Armor Points. The only exception to this rule is that all BattleMechs may carry up to 9 Armor Points on their heads.

Note that the center, left and right torso locations mount both front and rear armor. The armor allocated to the front of a torso location cannot be used to protect the rear of that location, and vice versa. The total armor allocated to the front and rear of a torso location cannot be greater than twice the number of the location's Internal Structure boxes.

Use the Armor Diagram on the record sheet to indicate the number of Armor Points protecting each part of the BattleMech's body. Mark out any excess boxes in the same way as for the Internal Structure Diagram.

**Maximum Armor:** For ease of reference, the maximum total Armor Factor for each tonnage of 'Mech is shown on the Internal Structure Table (p. 110). Note that it is always permissible for a 'Mech to have the maximum possible armor, even if this requires leaving a few points of armor unallocated. For example, a 50-ton 'Mech can have a maximum armor factor of 169. In order to get this much standard armor, a 'Mech must have 11 tons of armor ( $11 \times 16 = 176$ ). The extra 7 points of armor that cannot be assigned are simply lost.

**Criticals:** Note that carrying ferro-fibrous armor requires the player to fill in critical slots on the BattleMech's Critical Hit Table. Inner Sphere ferro-fibrous fills 14 critical slots, while the Clan version fills in 7.

*Blaine wants his 'Mech to have as much armor as possible, but he's pretty sure there won't be enough critical slots open for ferro-fibrous. He chooses standard armor, so in order to get the maximum amount without wasting any points, he assigns 9.5 tons of armor to the Wyvern, giving it a total Armor Factor of 152 ( $9.5 \times 16 = 152$ ), just 1 point shy of the absolute maximum for a 45-ton 'Mech. This leaves him with 17 tons for weapons and equipment ( $26.5 - 9.5 = 17$ ).*

*Because it has nearly maximum armor, assigning it to locations will be easy. Each arm has 7 internal structure, so it can mount 14 points of armor. Each leg's internal structure is 11, so Blaine assigns 22 points of armor to the legs. The head gets the maximum 9 points of armor, and each side torso can mount 22 points of armor. Blaine puts 16 on the front and 6 on the rear. Since he is 1 point short of maximum, Blaine puts 27 points of armor on the center torso ( $14 \text{ internal} \times 2 = 28 - 1 = 27$ ), placing 7 in the rear and 20 on the front. Checking his math, he confirms that he has assigned all 152 Armor Points ( $14 + 14 + 22 + 22 + 9 + 22 + 22 + 27 = 152$ ).*

## Add Weapons, Ammunition and Other Equipment

Every weapon or piece of equipment placed on a BattleMech weighs a certain amount, as shown in the Tons column of the Weapons and Equipment Tables. Select the weapons and equipment that the new BattleMech will carry from the appropriate table based on the technology base, either Inner Sphere or Clan.

**Ammunition:** Add at least 1 ton (1/2 ton for machine guns) of ammunition for each class of missile launcher or ballistic weapon. By class, we mean each distinct type of launcher as well as the number of missiles in the salvo. For example, a 'Mech with an SRM-4, SRM-6, LRM-5 and LRM-20 would have to have at least 4 tons of ammunition, one for each launcher. On the other hand, a 'Mech with four SRM-2 launchers would only require 1 ton of ammo, because all four launchers are the same

## BATTLETECH® BATTLEMECH RECORD SHEET

### ARMOR DIAGRAM

#### Mech Data

Type: WVE-SM Wyvern      Tonnage: 45  
 Movement Points: 4      Technology Base: 3050  
 Walking: 4      Inner Sphere  
 Running: 6  
 Jumping: 4

#### Weapons Inventory

Type	Location	Heat	Damage	Mt.	Short	Med.	Long
1 LRM 10	CT	4	1	8	7	14	21
1 Large Laser	RA	8	8	-	5	10	15
2 Small Laser	RA	1	3	-	1	2	3
1 SRM 6	RT	4	2	-	3	6	9

#### Warrior Data

Name: \_\_\_\_\_  
 Gunnery Skill: \_\_\_\_\_ Piloting Skill: \_\_\_\_\_  
 Hits Taken: 

1	2	3	4	5	6
---	---	---	---	---	---

  
 Consciousness #: 

3	5	7	10	11	12
---	---	---	----	----	----

#### Heat Scale

30	Shutdown
29	
28	
27	
26	Ammo Explosion, avoid on 6+
25	-3 Movement Points
24	-4 Modifier to Fire
23	Ammo Explosion, avoid on 6+
22	Shutdown, avoid on 6+
21	-3 Modifier to Fire
20	-4 Movement Points
19	Ammo Explosion, avoid on 4+
18	Shutdown, avoid on 6+
17	-3 Modifier to Fire
16	-3 Movement Points
15	Shutdown, avoid on 4+
14	-2 Modifier to Fire
13	
12	
11	
10	-2 Movement Points
09	
08	-1 Modifier to Fire
07	
06	
05	
04	
03	-1 Movement Points
02	
01	
00	

### Critical Hit Table

Location	Equipment	Heat	Damage	Mt.	Short	Med.	Long
Left Arm	1. Shoulder						
	2. Upper Arm Actuator						
	3. Lower Arm Actuator						
	4. Hand Actuator						
	5. Endo Steel						
	6. Roll Again						
Right Arm	1. Shoulder						
	2. Upper Arm Actuator						
	3. Lower Arm Actuator						
	4. Hand Actuator						
	5. Large Laser						
	6. Small Laser						
Center Torso	1. Life Support						
	2. Sensors						
	3. Cockpit						
	4. Heat Sink						
	5. Sensors						
	6. Life Support						
Left Torso (Case)	1. Gyro						
	2. Engine						
	3. Engine						
	4. Gyro						
	5. Gyro						
	6. Gyro						
Right Torso (Case)	1. Gyro						
	2. Engine						
	3. Engine						
	4. Gyro						
	5. Gyro						
	6. Gyro						
Left Leg	1. Hip						
	2. Upper Leg Actuator						
	3. Lower Leg Actuator						
	4. Foot Actuator						
	5. Jump Jet						
	6. Endo Steel						
Right Leg	1. Hip						
	2. Upper Leg Actuator						
	3. Lower Leg Actuator						
	4. Foot Actuator						
	5. Jump Jet						
	6. Endo Steel						

Cost 3,470,885

BATTLETECH is a Registered Trademark of FASA Corporation. Copyright 1998. Permission to photocopy for personal use.

class, and therefore can draw ammo from the same bin. This required ammunition provides a varying number of shots, depending on the launcher or weapon. (Note that one-shot weapons can have no additional ammo).

**OmniMechs:** Players creating OmniMechs need not mount weapons at this stage. Any portion of their equipment can be mounted normally, known as "fixed" equipment. The remaining tonnage is allocated to weapons and equipment pods. At the start of each game, a player with an OmniMech then adds appropriate weapons and equipment up to this allocated tonnage and the open critical slots (see *Outfitting an OmniMech*, p. 120).

**Criticals:** The number of open critical slots remaining on the Critical Hits Table in a given location limits the number of weapons and other equipment that may be placed in that location. Many weapons take up more than one critical slot, as shown on the Weapons and Equipment Tables. For example, the center torso has only 2 slots left open on its Critical Hit Table, but a PPC takes up 3 spaces. Therefore, the player cannot place a PPC in a BattleMech's center torso.

Note that certain pieces of equipment must be assigned to specific locations on the BattleMech's Critical Hit Table. For

example, XL engine critical slots must be placed in the right and left torso locations.

The critical slots for AC/20-type weapons and artillery weapons (Arrow IV, Thumper and Sniper) can be split between two adjacent locations. Triple-strength myomer can be split among any number of locations. For all other weapons and equipment, all critical slots must be in a single location unless the description of the item specifically states otherwise.

The location chosen for a weapon will govern its firing arc. Weapons split between two locations have the firing arc of the most restrictive location. For example, an AC/20 split between the right arm and the right torso would fire as a right torso weapon, into the forward firing arc only. Weapons can be rear-mounted in the head, torso, or legs, in which case the weapon should be marked with an (R) on the record sheet.

Each ton of ammunition occupies 1 critical slot, but that slot need not be in the same location as the weapon that uses the ammo. Note that though machine gun ammo can be acquired in half-ton lots, a critical slot can accommodate a full ton of MG ammo.

*Blaine decides to start with the large weapons and work his way down. For long-range punch, he gives the Wyvern an LRM-10 launcher (5 tons) with 1 ton of ammunition, mounting the weapon in the center torso (filling it) and placing the ammo in the left torso, leaving 8 slots open there. A large laser is chosen as a strong main weapon with no ammo restrictions (5 tons), which is placed in the right arm for a wide field of fire, leaving 6 critical slots open there.*

*After choosing the main weapons for the Wyvern, Blaine sees that he has 6 tons left (17 - 5 - 1 - 5 = 6). He chooses an SRM-6 as a strong back-up weapon (3 tons) and gives it a ton of ammo. He places both in the right torso, leaving 6 critical slots open there. For added short-range firepower Blaine adds two small lasers in the right arm, weighing a half ton each. This leaves 4 open slots in the right arm, and still 1 ton unassigned (6 - 3 - 1 - 0.5 - 0.5 = 1). Since his 'Mech is based around its toughness, Blaine decides to fill out the design by adding cellular ammunition storage equipment (CASE) to both the right and left torsos, at a half ton per location. There are still 5 open slots in the right torso and 7 open in the left.*

*Pleased by his creation, Blaine suddenly realizes he almost forgot to assign the critical space for the endo steel internal structure, which he simply noted in the Design the Chassis step! Because this is an Inner Sphere 'Mech, it will fill 14 critical slots anywhere in the 'Mech. Blaine fills 1 slot in each leg, 4 in each side torso, and 2 in each arm, for a total of 14 (1 + 1 + 4 + 4 + 2 + 2 = 14). The WVE-5N Wyvern is complete!*

# CONSTRUCTION

## INNER SPHERE WEAPONS AND EQUIPMENT TABLE

Type	Heat	Damage	Minimum Range	Short Range	Medium Range	Long Range	Tons	Critical Slots	Ammo Per Ton
<i>Energy Weapons</i>									
ER Large Laser	12	8	—	1-7	8-14	15-19	5	2	—
ER Medium Laser	5	5	—	1-4	5-8	9-12	1	1	—
ER Small Laser	2	3	—	1-2	3-4	5	0.5	1	—
Flamer	3	2	—	1	2	3	1	1	—
Large Laser	8	8	—	1-5	6-10	11-15	5	2	—
Medium Laser	3	5	—	1-3	4-6	7-9	1	1	—
Small Laser	1	3	—	1	2	3	0.5	1	—
PPC	10	10	3	1-6	7-12	13-18	7	3	—
ER PPC	15	10	—	1-7	8-14	15-23	7	3	—
Pulse Laser (Large)	10	9	—	1-3	4-7	8-10	7	2	—
Pulse Laser (Medium)	4	6	—	1-2	3-4	5-6	2	1	—
Pulse Laser (Small)	2	3	—	1	2	3	1	1	—
<i>Ballistic Weapons</i>									
Anti-Missile System	1	*	—	—	—	—	0.5	1	12
Autocannon/2	1	2	4	1-8	9-16	17-24	6	1	45
Autocannon/5	1	5	3	1-6	7-12	13-18	8	4	20
Autocannon/10	3	10	—	1-5	6-10	11-15	12	7	10
Autocannon/20	7	20	—	1-3	4-6	7-9	14	10	5
Flamer (Vehicle)	3	2	—	1	2	3	0.5	1	20
Gauss Rifle	1	15	2	1-7	8-15	16-22	15	7	8
Light Gauss Rifle	1	8	3	1-8	9-17	18-25	12	5	16
LB 2-X AC	1	2	4	1-9	10-18	19-27	6	4	45
LB 5-X AC	1	5	3	1-7	8-14	15-21	8	5	20
LB 10-X AC	2	10	—	1-6	7-12	13-18	11	6	10
LB 20-X AC	6	20	—	1-4	5-8	9-12	14	11	5
Machine Gun	0	2	—	1	2	3	0.5	1	200
Ultra AC/2	1	2	3	1-8	9-17	18-25	7	3	45
Ultra AC/5	1	5	2	1-6	7-13	14-20	9	5	20
Ultra AC/10	4	10	—	1-6	7-12	13-18	13	7	10
Ultra AC/20	8	20	—	1-3	4-7	8-10	15	10	5
<i>Missile Weapons</i>									
LRM 5	2	1/missile	6	1-7	8-14	15-21	2	1	24
LRM 10	4	1/missile	6	1-7	8-14	15-21	5	2	12
LRM 15	5	1/missile	6	1-7	8-14	15-21	7	3	8
LRM 20	6	1/missile	6	1-7	8-14	15-21	10	5	6
MRM 10	4	1/missile	—	1-3	4-8	9-15	3	2	24
MRM 20	6	1/missile	—	1-3	4-8	9-15	7	3	12
MRM 30	10	1/missile	—	1-3	4-8	9-15	10	5	8
MRM 40	12	1/missile	—	1-3	4-8	9-15	12	7	6
Narc Missile Beacon	0	*	—	1-3	4-6	7-9	3	2	6
SRM 2	2	2/missile	—	1-3	4-6	7-9	1	1	50
SRM 4	3	2/missile	—	1-3	4-6	7-9	2	1	25
SRM 6	4	2/missile	—	1-3	4-6	7-9	3	2	15
Streak SRM 2	2	*	—	1-3	4-6	7-9	1.5	1	50
Streak SRM 4	3	*	—	1-3	4-6	7-9	3	1	25
Streak SRM 6	4	*	—	1-3	4-6	7-9	4.5	2	15

# CONSTRUCTION

Type	Heat	Damage	Minimum Range	Short Range	Medium Range	Long Range	Tons	Critical Slots	Ammo Per Ton
<i>Artillery Weapons*</i>						<i>Maximum</i>			
Arrow IV System	10	20/10*	—	—	—	5 Maps	15	15	5
Long Tom	20	20/10*	—	—	—	20 Maps	30	30	5
Sniper	10	10/5*	—	—	—	12 Maps	20	20	10
Thumper	6	5/2*	—	—	—	14 Maps	15	15	20
<i>Other Equipment*</i>									
Anti-Personnel Pod	0	*	—	—	—	—	0.5	1	—
Artemis IV FCS	—	—	—	—	—	—	1	1	—
Beagle Active Probe	—	—	—	—	—	4	1.5	2	—
CASE	—	—	—	—	—	—	0.5	1	—
C <sup>3</sup> Computer (Master)	—	—	—	—	—	—	5	5	—
C <sup>3</sup> Slave	—	—	—	—	—	—	1	1	—
Guardian ECM Suite	—	—	—	—	—	6	1.5	2	—
Hatchet	0	*	—	—	—	—	***	***	—
Double Heat Sink	-2	—	—	—	—	—	1	3	—
Heat Sink	-1	—	—	—	—	—	1	1	—
MASC	—	—	—	—	—	—	**	**	—
Sword	0	*	—	—	—	—	*	*	—
TAG	0	—	—	1-5	6-9	10-15	1	1	—
Triple-Strength Myomer	*	—	—	—	—	—	0	6	—

\* See special rules for this equipment.

\*\* 'Mech Tonnage ÷ 20

\*\*\* 'Mech Tonnage ÷ 15

## CLAN WEAPONS AND EQUIPMENT TABLE

Type	Heat	Damage	Minimum Range	Short Range	Medium Range	Long Range	Tons	Critical Slots	Ammo Per Ton
<i>Energy Weapons</i>									
ER Laser (Large)	12	10	—	1-8	9-15	16-25	4	1	—
ER Laser (Medium)	5	7	—	1-5	6-10	11-15	1	1	—
ER Laser (Small)	2	5	—	1-2	3-4	5-6	0.5	1	—
ER Laser (Micro)	1	2	—	1	2	3-4	0.25	1	—
Heavy Laser (Large)	18	16	—	1-5	6-10	11-15	4	3	—
Heavy Laser (Medium)	7	10	—	1-3	4-6	7-9	1	2	—
Heavy Laser (Small)	3	6	—	1	2	3	0.5	1	—
Flamer	3	2	—	1	2	3	0.5	1	—
ER PPC	15	15	—	1-7	8-14	15-23	6	2	—
Pulse Laser (Large)	10	10	—	1-6	7-14	15-20	6	2	—
Pulse Laser (Medium)	4	7	—	1-4	5-8	9-12	2	1	—
Pulse Laser (Small)	2	3	—	1-2	3-4	5-6	1	1	—
Pulse Laser (Micro)	1	3	—	1	2	3	0.5	1	—
<i>Ballistic Weapons</i>									
Anti-Missile System	1	*	—	—	—	—	0.5	1	24
Flamer (Vehicle)	3	2	—	1	2	3	0.5	1	20
Gauss Rifle	1	15	2	1-7	8-15	16-22	12	6	8
LB 2-X AC	1	2	4	1-10	11-20	21-30	5	3	45
LB 5-X AC	1	5	3	1-8	9-15	16-24	7	4	20
LB 10-X AC	2	10	—	1-6	7-12	13-18	10	5	10

# CONSTRUCTION

## CLAN WEAPONS AND EQUIPMENT TABLE (CONTINUED)

Type	Heat	Damage	Minimum Range	Short Range	Medium Range	Long Range	Tons	Critical Slots	Ammo per ton
LB 20-X AC	6	20	—	1-4	5-8	9-12	12	9	5
Heavy Machine Gun	0	3	—	1	2	—	0.5	1	100
Machine Gun	0	2	—	1	2	3	0.25	1	200
Light Machine Gun	0	1	—	1-2	3-4	5-6	0.25	1	200
Ultra AC/2	1	2	2	1-9	10-18	19-27	5	2	45
Ultra AC/5	1	5	—	1-7	8-14	15-21	7	3	20
Ultra AC/10	3	10	—	1-6	7-12	13-18	10	4	10
Ultra AC/20	7	20	—	1-4	5-8	9-12	12	8	5
<i>Missile Weapons</i>									
LRM 5	2	1/missile	—	1-7	8-14	15-21	1	1	24
LRM 10	4	1/missile	—	1-7	8-14	15-21	2.5	1	12
LRM 15	5	1/missile	—	1-7	8-14	15-21	3.5	2	8
LRM 20	6	1/missile	—	1-7	8-14	15-21	5	4	6
Narc Missile Beacon	0	*	—	1-4	5-8	9-12	2	1	6
SRM 2	2	2/missile	—	1-3	4-6	7-9	0.5	1	50
SRM 4	3	2/missile	—	1-3	4-6	7-9	1	1	25
SRM 6	4	2/missile	—	1-3	4-6	7-9	1.5	1	15
Streak SRM 2	2	*	—	1-4	5-8	9-12	1	1	50
Streak SRM 4	3	*	—	1-4	5-8	9-12	2	1	25
Streak SRM 6	4	*	—	1-4	5-8	9-12	3	2	15
<i>Artillery Weapons*</i>									
Arrow IV System	10	20/10*	—	—	—	6 Maps	12	12	5
Long Tom	20	20/10*	—	—	—	20 Maps	30	30	5
Sniper	10	10/5*	—	—	—	12 Maps	20	20	10
Thumper	6	5/2*	—	—	—	14 Maps	15	15	20
<i>Other Equipment *</i>									
Active Probe	—	—	—	—	—	5	1	1	—
Light Active Probe	—	—	—	—	—	3	0.5	1	—
Anti-Personnel Pod	0	*	—	—	—	—	0.5	1	—
Artemis IV FCS	—	—	—	—	—	—	1	1	—
CASE	—	—	—	—	—	—	0	0	—
Double Heat Sink	-2	—	—	—	—	—	1	2	—
Heat Sink	-1	—	—	—	—	—	1	1	—
ECM Suite	—	—	—	—	—	6	1	1	—
MASC	—	—	—	—	—	—	**	**	—
TAG	0	—	—	1-5	6-9	10-15	1	1	—
Light TAG	0	—	—	1-3	4-6	7-9	0.5	1	—
Targeting Computer	—	—	—	—	—	—	*	*	—

\* See special rules for this equipment.

\*\* 'Mech Tonnage ÷ 25

# CONSTRUCTION

## VEHICLE TABLE

### Ground Vehicles

Tracked  
 Maximum Tonnage 100  
 Suspension Factor 0  
 Terrain Restrictions No Heavy Woods or Water

### Wheeled

Maximum Tonnage 80  
 Suspension Factor 20  
 Terrain Restrictions No Rough, Rubble, Woods, or Water

### Hovercraft

Maximum Tonnage 50  
 Suspension Factor:  
*Vehicle Tons                      Suspension Factor*  
 01-10 40  
 11-20 85  
 21-30 130  
 31-40 175  
 41-50 235  
 Lift Equipment 10% of hovercraft tonnage  
 Minimum Engine Weight 20% of hovercraft tonnage  
 Terrain Restrictions No Woods

### Naval Vehicles

Hydrofoils  
 Maximum Tonnage 100  
 Suspension Factor:

(Continued in next column)

### Vehicle Tons

01-10 60  
 11-20 105  
 21-30 150  
 31-40 195  
 41-50 255  
 51-60 300  
 61-70 345  
 71-80 390  
 81-90 435  
 91-100 480

### Suspension Factor

Water hexes of Depth 1+ only  
 10% of hydrofoil tonnage

### Displacement Hulls and Submarines

Maximum Tonnage 300  
 Suspension Factor 30  
 Terrain Restrictions Water hexes of Depth 1+ only  
 Submarine Diving Equipment 10% of submarine tonnage

### VTOLs

Maximum Tonnage 30  
 Lift Factor:  
*Vehicle                      Lift*  
*Tons                          Factor*  
 01-10 50  
 11-20 95  
 21-30 140  
 Lift Equipment 10% of VTOL tonnage

## VEHICLE CONSTRUCTION

The following system makes it possible for players to construct unique vehicles and pit these designs against other custom and standard machines on the battlefield.

The vehicle design process is very similar to the BattleMech design process. Follow the 'Mech construction rules when building vehicles except as specifically noted below.

Unlike BattleMechs, vehicles do not have critical slots to fill, so they are not restricted in that way. However, vehicles do have a limit to the amount of equipment they can carry, as explained below.

### Vehicle Space Limits

Though the open construction of vehicles allows them to carry more equipment than BattleMechs, limits do exist. Because vehicles do not have critical slots like 'Mechs, they are limited only by the total number of items they can carry, regardless of their size. A vehicle can mount a base of 5 items of equipment. Because larger vehicles can carry more equipment, add 1 item to this base per 5 full tons of vehicle weight. For example, a 22-ton hovercraft can mount up to 9 items, while a 75-ton tank can mount as many as 20.

Each weapon and piece of special equipment counts as 1 item. For construction purposes, all ammunition carried for a particular class of launcher or weapon (LRM-10, AC/5, SRM-4, LRM-20, and so on) counts as 1 item, regardless of the number of tons carried. If the vehicle has a cargo hold or infantry bay, it counts as a single item, regardless of its size. Heat sinks, engines and other integral equipment are not considered "items" unless specifically designated as such in the item's rules.

### DESIGN THE CHASSIS

To start the construction process, the player must make certain basic choices about his vehicle. These will determine what kind of vehicle it is and will restrict the designer's access to certain equipment. The choices to be made are the vehicle's technology base, type and tonnage. These choices in turn will determine the internal structure's mass. Finally, every vehicle must have cockpit control components, and certain vehicle types require additional lift or dive equipment.

## Choose Vehicle Type

The most basic decision about a vehicle is its type, because every type of vehicle is different in several important ways. A vehicle can have only one type, chosen from the following seven: Tracked, Wheeled, Hovercraft, Hydrofoil, Displacement Hull, Submarine or VTOL. A vehicle's construction and movement are limited by its type as shown on the Vehicle Table.

## Determine Technology Base

Vehicles may be constructed using one of two available technology bases, Inner Sphere or Clan. Though they did not use combat vehicles in the invasion of the Inner Sphere, the Clans can and do construct them. The player must also choose whether the vehicle that he is designing is an OmniVehicle or a standard vehicle. (See *Outfitting an OmniMech*, page 120, for more information on OmniVehicles.)

## Choose Tonnage

Vehicle weight is limited by type, as shown in the Vehicle Table, p. 118. Players may choose any tonnage within these limits and are not limited to 5-ton increments. The total weight of the vehicle's engine, weapons, armor and other components may not exceed or fall short of this amount.

## Add Cockpit and Control Components

Every vehicle must have a cockpit, which combines the equipment necessary to control the craft in combat. These control components take up 5 percent of the vehicle's total tonnage (rounded up to the nearest half ton).

## Allocate Tonnage for Internal Structure

A vehicle's internal structure takes up 10 percent of its total weight (rounded up to the nearest half ton). Each of the vehicle's 5 damage locations (4 if it has no turret or rotor) receives 1 internal structure box for every 10 tons of the vehicle's total tonnage (rounded up). Note that vehicles may not use endo steel structure.

## Add Lift Equipment/Rotors/Diving Equipment

Hovercraft, hydrofoils, VTOLs and submarines all use special equipment to achieve their unique movement. This equipment weighs 10 percent of the vehicle's total tonnage (rounded up to the nearest half ton).

## ADD OTHER EQUIPMENT

After the player designs the framework of the vehicle, he chooses the other equipment the vehicle will carry. These elements include the engine, armor, and weapons and other equipment.

## Determine Engine Rating

Each vehicle carries one power plant to power its movement and other systems. A vehicle's engine rating is determined by its weight, desired speed and suspension or lift factor. Multiply the vehicle's tonnage by its desired Cruising MP,

then subtract the suspension/lift factor (see Suspension Factor or Lift Factor in the Vehicle Table) from this total. The result is the vehicle's engine rating.

$(\text{Tonnage} \times \text{Desired Cruising MP}) - \text{Suspension/Lift Factor} = \text{Engine Rating}$

For example, a player creates a 25-ton hovercraft with a Cruising MP of 10 ( $25 \times 10 = 250$ ). The suspension factor for a 25-ton hovercraft is 130. This hovercraft needs an engine with a rating of 120 ( $250 - 130 = 120$ ). (See Fusion Engine Table, p. 111).

Players may choose whether their vehicle will use a fusion or internal combustion engine. An internal combustion engine (ICE) weighs twice as much as an identically rated fusion engine, but ICE engines are cheaper and more readily available. Also, vehicles with fusion engines must add extra shielding and transmission equipment, increasing the weight of the engine by 50 percent (multiply engine weight by 1.5 and round up to the nearest half ton). A player may select an XL version of the fusion engine if he wishes (see *XL Engines*, p. 134 in *Equipment*), which cuts the total weight of the engine plus shielding in half (rounded up to the nearest half ton). Inner Sphere XL engines count as 2 items for the purpose of space limits. Clan XL engines count as 1 item. Internal combustion engines are not available in the XL variant.

## Add Armor

Armor helps protect the vehicle's internal structure. Armor can be standard or ferro-fibrous. For each ton of standard armor selected, the vehicle has 16 Armor Points. Ferro-fibrous armor gives the vehicle more Armor Points per ton (see *Ferro-Fibrous Armor*, p. 127 in *Equipment*).

Determine the total tonnage of armor the vehicle will carry. Armor must be added in 1/2- or 1-ton lots. Multiply the tonnage of armor chosen by 16 to find the vehicle's total Armor Points. If the vehicle has ferro-fibrous armor, this total is further multiplied, by 1.12 for Inner Sphere vehicles or 1.2 for Clan vehicles, and rounded normally (up on .5) to find the total ferro-fibrous armor.

Divide the total number of Armor Points carried by the vehicle among the 5 locations shown on the Vehicle Record Sheet (4 for vehicles without a turret or rotor).

**Maximum Armor:** The player chooses the exact number of Armor Points used to protect each location—the number of Armor boxes and Internal Structure boxes shown on the record sheet does not represent limitations on how much armor may be assigned to a location. However, a VTOL's rotor may carry no more than 2 points of armor.

## Add Weapons, Ammunition, Heat Sinks and Other Equipment

Weapons and other equipment are added to vehicles in the same way as to BattleMechs, including the minimum ammunition requirements and the note about OmniVehicles and pod tonnage. The main difference, as stated in *Vehicle Space*

Limits, p. 118, is that a vehicle may only carry a certain number of items based on its tonnage. Other differences are noted below.

**Heat Sinks:** Vehicles do not require heat sinks for their ballistic, missile or artillery weapons. Only energy weapons require heat sinks, as described below. Vehicles cannot mount double heat sinks.

**Energy Weapons:** Energy weapons mounted on vehicles may require extra equipment, depending on the type of engine installed. The number of heat sinks installed in a vehicle must be equal to the number of Heat Points that all mounted energy weapons can generate in 1 turn. Remember that all fusion plants are designed with 10 integral heat sinks built in at no cost in

tonnage. The player must add more heat sinks if the vehicle's weapons require more. Note that vehicles combining internal combustion engines and energy weapons do not come equipped with the standard 10 built-in heat sinks, and also require power amplifiers at a ratio of 1 ton per 10 tons of energy weapons (round up to the nearest 0.1 ton).

**Turrets:** Most vehicles will mount some or all of their weapons in turrets. Any number of weapons can be mounted in a turret. A vehicle may have only 1 turret, except VTOLs, which may not mount turrets. A turret weighs 10 percent of the tonnage of the mounted weapons (round up to the nearest half ton). If a weapon is not mounted in a turret, it will have a fixed arc of fire in the direction that it is mounted.

## OUTFITTING AN OMNIMECH

Unlike standard BattleMechs, OmniMechs are designed with modular weapon pods, allowing their configurations to be changed between battles to customize them quickly for a variety of roles. It is also possible to create OmniVehicles with the same ability. Unless stated otherwise below, the following rules apply to both OmniMechs and OmniVehicles.

Unless the scenario setup or tournament rules say otherwise, players may customize their OmniMechs to best suit the conditions of each battle by adding special equipment and weapons. Each OmniMech design indicates the machine's fixed features and specifies a number of tons available as pod space for additional gear. Certain types of equipment can be installed on any OmniMech, subject to weight and space limitations.

## USING ADD-ON PODS

When preparing an OmniMech for battle, use the descriptions of the base OmniMech design (containing only fixed components) to determine the available tonnage for add-on pods. The equipment in the add-on pods cannot exceed this tonnage.

Designate a location for each pod to be attached to the OmniMech. The locations selected must have sufficient critical slots available for the systems being added.

The location and contents of all add-on pods must be designated before the battle begins.

**Actuators:** Lower arm and hand actuators are themselves mounted as pods on OmniMechs, so they may be attached and detached freely between battles. They cannot be mounted on an arm that will carry any

# BATTLETECH

## GROUND VEHICLE RECORD SHEET

Unit Type: <b>VEPETTE MID TANK</b>			Driving Skill: <b>5</b>		
Movement Type: <b>TRACK</b>	Cruising MP: <b>5</b>	Flank MP: <b>8</b>	Gunnery Skill: <b>4</b>		
Tonnage: <b>50</b>			<b>Weapons and Ammo</b>		
Engine Rating: <b>250</b>	Tonnage: <b>25</b>	Fusion: <input checked="" type="checkbox"/>	AC/5 TURRET		
Control Tonnage: <b>2.5</b>	Lift Equipment: <b>0</b>	AMMO (AC/5) 20 BODY			
Power Amplifier: <b>0</b>	Heat Sinks: <b>0</b>	MACHINE GUN FRONT			
Internal Structure: <b>5.0</b>			AMMO (MG) 200 BODY		
Turret: <b>0.8</b>					
Armor tons: <b>6</b>	Armor points: <b>96</b>				
Front:	<b>20</b>				
Left/Right side:	<b>18 // 18</b>				
Rear:	<b>20</b>				
Turret:	<b>20</b>				

type of PPC, autocannon, or Gauss rifle. The player may choose whether to use actuators in conjunction with other arm-mounted weapons. If the player decides not to mount actuators, the appropriate arm actuator and hand actuator slots of the Arm Critical Hits Table are considered empty and may be used as extra critical slots for arm-mounted weapons. If an OmniMech's arm lacks a hand actuator, it cannot use that hand for any purpose (lifting, carrying, using clubs, and so on). OmniMechs without hand and/or arm actuators suffer the usual restrictions and benefits of 'Mechs created without those actuators.

**Battlefield Salvage:** OmniMechs are designed to be versatile, and as such they can accept pods from any other OmniMech, whether Inner Sphere or Clan. As long as the item being added came from an OmniMech and is undamaged, it can be added to any other OmniMech with no additional repair difficulty and no risk of unbalancing the 'Mech. This does not apply to new OmniMech designs, which must be created with a single technology base as usual. See *Scavenging and Repair*, page 82, for more information on customizing and using salvage.

**OmniVehicles:** Turrets must be designed to support a maximum tonnage. The weight of the turret remains constant regardless of the tonnage of the equipment mounted in the turret. For example, an OmniVehicle with a 2-ton turret can mount up to 20 tons of equipment in the turret.

## Weapons

Players can always install weapons, provided that sufficient critical slots and tonnage remain available. When mounting weapons, be sure to allow space for and include ammunition for

those that require it. Weapon pods for Clan OmniMechs automatically include the CASE ammo-protection feature (see *CASE*, p. 126 in *Equipment*) at no cost in space or weight. Inner Sphere OmniMechs must mount CASE normally.

## Heat Sinks

The fixed heat sinks for an OmniMech are added per the standard rules. This means some of the heat sinks must be integral to the engine, and others must be placed in critical slots. The fixed heat sinks may not be moved later.

Players may add additional heat sinks to an OmniMech if slots are available. Heat sinks may be mounted in pods attached to any portion of the OmniMech, provided sufficient critical slots are open in the chosen location. Additional heat sinks added as pods always take up critical slots, even if the 'Mech could have had more heat sinks integral to the engine than it used. For example, if an OmniMech with a 350-rated engine has 10 fixed heat sinks, none of these heat sinks need to be assigned to critical slots, because the engine can accommodate up to 14 heat sinks ( $350 \div 25 = 14$ ). If one of the configurations of this 'Mech adds five more heat sinks, all five must be assigned to critical slots, even though the engine could have held 4 more. Because they were not fixed but added later as pods, they all must be placed in critical slots.

Be sure to install compatible heat sinks; some OmniMech designs use standard heat sinks, but most use double heat sinks. No 'Mech may combine single and double heat sinks.

## Jump Jets

Players may add jump jets to any OmniMech, whether or not its standard configuration has jump jets. Jump jets may only be mounted in pods on the left and right legs, the left and right torsos, and the center torso, and these locations must have

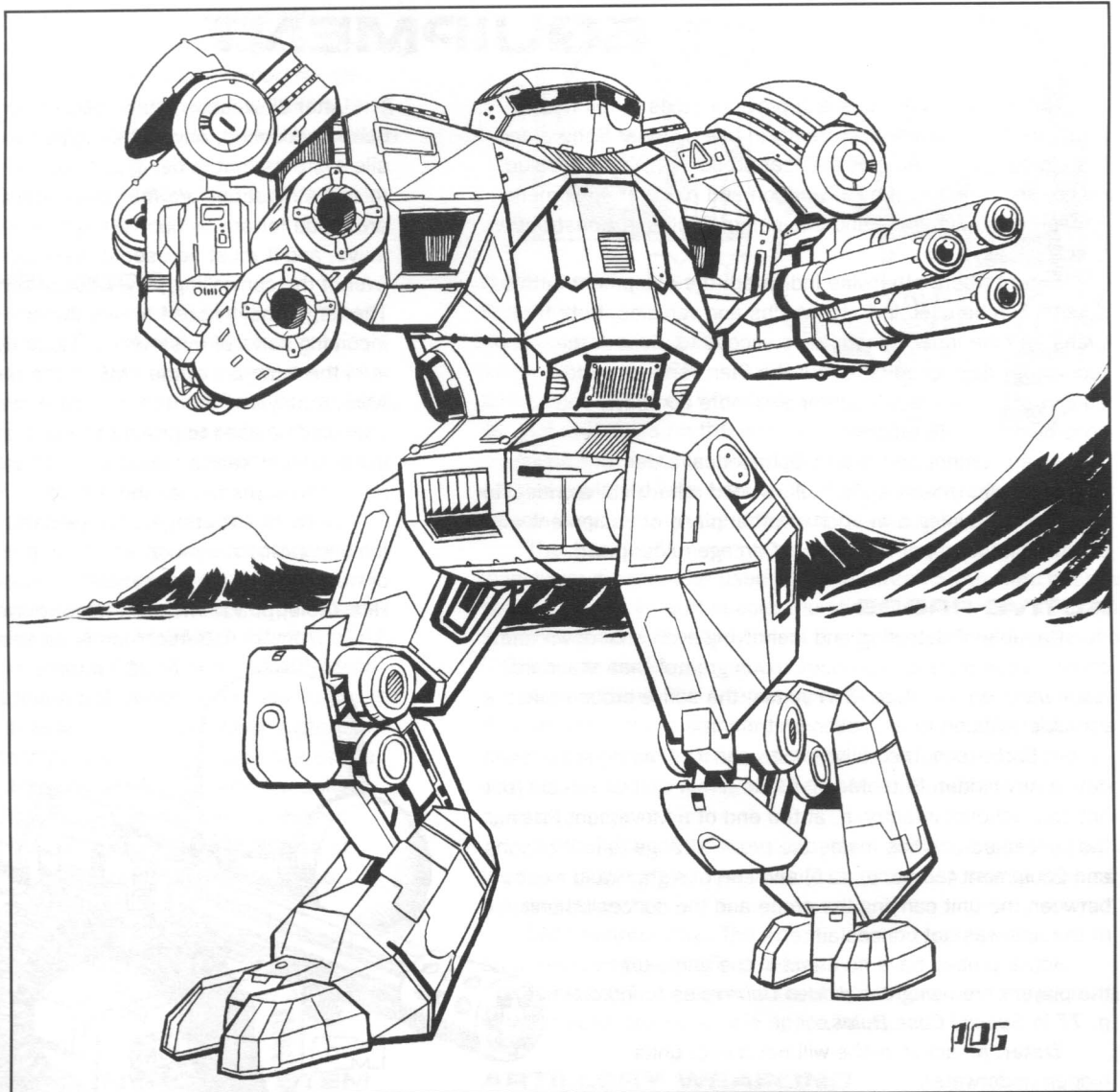

sufficient critical slots open. Use the *Determine Jump Capability* rules, p. 112, for determining the necessary tonnage of jets to give the OmniMech the desired jump capacity.

## Electronics

Probes, targeting gear, and other high-tech electronics may be mounted in OmniMech pods or individually elsewhere on the 'Mech, provided there are sufficient slots available in the chosen hit location to fit the gear.

## Other Equipment

OmniMech pods can accommodate any of the equipment described in *Equipment*, beginning on p. 122, including anti-missile systems, A-pods and so on, unless the rules for that equipment state otherwise. However, engines, endo steel, MASC, triple-strength myomer and armor cannot be added to an OmniMech using pod technology, for obvious reasons.

## EQUIPMENT

This section describes and provides rules for all known weapons and equipment currently in use by Inner Sphere and Clan forces. The statistics for heat produced, Damage Value, range, and tonnage of each weapon and piece of equipment appear in the Weapons and Equipment Tables in *Construction*, p. 115.

Except where otherwise indicated, the equipment in this section can be used in BattleMechs and vehicles. Both the Clans and the Inner Sphere have access to most of the technology discussed here, but the Clan versions of this equipment are generally lighter and more compact, and so considerably more efficient.

All equipment appears in alphabetical order.

**Criticals:** Unless specifically stated otherwise, a critical hit to a slot containing a weapon or other piece of equipment will disable that item per the *Critical Damage* rules, p. 35.

### ACTIVE PROBE

Capable of detecting and identifying even shut-down and camouflaged units at distances much greater than standard-issue electronic warfare (EW) suites, the active probe makes a valuable addition to any recon unit.

In *BattleTech*, the active probe and its Clan equivalent will detect any hidden BattleMech, battle armor unit or vehicle (but not conventional infantry) if, at the end of a Movement Phase, the concealed unit lies inside the probe's range (see Weapons and Equipment tables, p. 115) and line of sight would exist between the unit carrying the probe and the concealed unit (if the unit was not concealed).

Active probes have no effect in the game unless the players are using the *Hidden Units* rules found on p. 77 in *Special Case Rules*.

**Water:** An active probe will not detect units hidden underwater.

### Light Active Probe

The Clans also employ a light active probe, which is smaller than the standard probe but has a shorter range.

### ANTI-MISSILE SYSTEM

The anti-missile system (AMS) is a rapid-fire, point-defense machine gun capable of tracking, engaging, and destroying incoming missiles. While very effective, the system's primary drawback is its high ammunition consumption. Both Clan and Inner Sphere anti-missile systems suffer from this handicap, though the Clans use flechette ammunition, increasing the number of rounds that can be stored in an ammo bin.

When a salvo of missiles attacks any BattleMech or vehicle equipped with an anti-missile system, the AMS automatically engages the salvo. A salvo is defined as all of the missiles launched from a single rack. For example, the 15 missiles launched from an LRM-15 rack are considered a salvo, as are the 2 missiles launched from a Streak SRM-2 rack.

After all weapon attack declarations and torso twists have been announced, any unit equipped with one or more anti-missile systems that is being attacked by one or more salvos of missiles must declare the target of each AMS, before to-hit rolls are made for any weapons. Each AMS may target only one salvo, and it must be used if there are any incoming salvos, even if the controlling player doesn't want to use the system. The target may choose to aim the anti-missile system at any incoming salvo of missiles, provided the unit that fired the salvo is in the firing arc of the AMS. If the target has more than one AMS, it may aim them at the same or different salvos. The AMS may only be used to protect the unit carrying it; it may not be used against salvos aimed at other units or targets, even if they are in the same hex as the AMS.

Once all AMS targets are declared, the to-hit rolls for the missile salvos are made as usual. If the attack hits, the number of missiles that hit are generated as usual using the Missile Hits Table, p. 31. Then the target player rolls 1D6 if the

BattleMech is using an Inner Sphere system, or 2D6 if the anti-missile system is Clan-built. The result is the number of missiles shot down, and also the amount of ammunition used by

the AMS. If this result indicates that the system spent more ammunition than was actually available, the system is out of ammunition. As long as there was at least one shot available to fire, the number of missiles destroyed remains valid.

The attacking player subtracts the AMS result from the number of missiles that hit and then applies the damage using the usual hit location procedure. If the AMS result equaled or exceeded the number of missile hits, the attack is completely shot down and no damage is inflicted.

If the missile salvo targeted by the AMS misses, the AMS still goes off, generating heat and expending ammo just as if the attack had hit.

An anti-missile system may be "turned off" during the End Phase of any turn. While it is turned off, the system will not engage any incoming missiles. Anti-missile systems that have been turned off may only be turned back on again in subsequent End Phases.

**Special Weapons:** The anti-missile system cannot be used against Arrow IV Artillery, Thunder, Flare, or Swarm or Swarm-I missiles, but it can be used against Narc pods, MRMs,

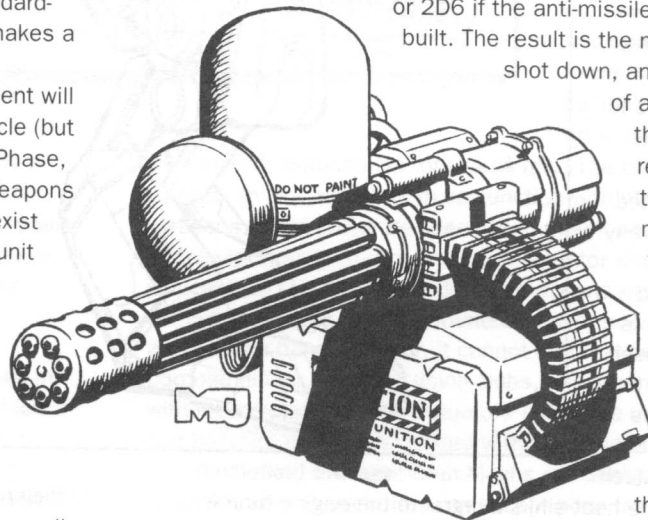

Flechette, Incendiary, Inferno, Semi-Guided, and Streak missiles. In the latter case, if the Streak to-hit roll fails, meaning the missiles fail to achieve lock-on (see *Streak Short-Range Missiles*, p. 129), the results of the anti-missile system's firing are disregarded; the weapon does not fire, uses no ammunition and does not create heat.

**Critical Hits:** Treat anti-missile system ammo as machine gun ammo for purposes of ammo explosions.

## ANTI-PERSONNEL PODS

Anti-Personnel pods (A-pods) consist of directional mines installed on the lower legs of a BattleMech—which is precisely where infantry must attack if they plan to plant explosives on the sensitive actuator mechanisms. When an A-pod is triggered, it blasts a cloud of shrapnel over an effective radius of roughly 15 meters, with a devastating effect against troops unfortunate enough to be in the open at the moment of the explosion.

Both Clan and Inner Sphere BattleMechs have access to A-pods. A-pods may only be mounted in the legs. Because A-pods are one-shot weapons, each can be used only once per game.

When infantry units make anti-Mech attacks or pointblank shots from hiding (see rules for *Anti-BattleMech Infantry*, p. 67, and *Hidden Units*, p. 77 in *Special Case Rules*), a BattleMech with an A-pod can defend itself by detonating the pod before the infantry player makes the to-hit roll. If the defender triggers an A-pod, any unarmored infantry platoon in the same hex as the BattleMech takes 1D6 – 1 points of damage before resolving its own attack. (This is an exception to the rule prohibiting weapons fire against units in the same hex.) Regardless of the damage caused, the A-pod is expended. A-pods do not affect battle armor.

**Criticals:** Unexpended A-pods that take a critical hit do not explode, but simply become inoperative. Expended A-pods can still be affected by a critical hit in the same way as empty ammo bins.

## ARTEMIS IV FIRE-CONTROL SYSTEM

The Artemis IV fire-control system improves the accuracy of standard missile launchers. Mounted in a dome near the launcher, the Artemis locks onto a target, illuminates it with an infrared beam and fires a spread of missiles. The system provides constant course-correction data to the missiles in flight using a tight-beam microwave communications link, which increases the number of missiles that hit the target.

Resolve any missile attack from an Artemis-equipped launcher per the standard rules. However, before consulting the Missile Hits Table, add 2 to the die roll result. This potentially increases the number of hits against the target.

Artemis units can be attached to any standard long- or short-range missile launcher. The system must be mounted in the same location on the BattleMech as the launcher it controls (though missile launchers mounted in the center torso may be controlled by an Artemis system mounted in the head). Each launcher requires its own Artemis system. If any type of missile system (i.e., LRM or SRM) aboard the BattleMech or vehicle is outfitted with the Artemis IV, all Artemis-compatible delivery

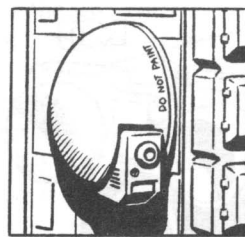

MQ

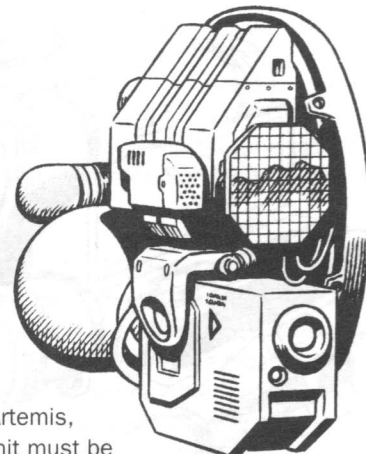

systems of that class

must be equipped in the same way. If any LRM

launcher is equipped with Artemis, all LRM launchers on the unit must be equipped with Artemis. If any SRM launchers are equipped with Artemis, all SRM launchers (but not Streak launchers) on the unit must be equipped with Artemis.

The Artemis IV may only be mounted on standard missile launchers; it cannot be used with the Streak SRM, Narc missile beacon, or any kind of special munitions unless those munitions specifically allow it in their rules. It may be used with single-shot (OS) missile packs.

**Ammunition:** The Artemis system uses special missiles that are identical to standard missiles for all game purposes except that they cost twice as much. If the launcher is loaded with normal ammo, it may still be used but functions as a normal launcher.

**Critical Hits:** If the Artemis system assigned to a specific launcher is destroyed, the missile launcher can still be fired as a normal launcher.

**LRM Indirect Fire:** The Artemis system has no effect on LRM missiles that are fired indirectly.

**Vehicles:** The Artemis system is not considered a separate item for purposes of vehicle space limits.

## ARTILLERY WEAPONS

Generally mounted only in vehicles, but sometimes in BattleMechs, these extremely large projectile weapons enable players to launch shells at targets several kilometers away. The artillery weapons in common use are the Long Tom, Sniper, and Thumper, and the Arrow IV Missile Artillery System.

For more on artillery weapons and rules for their use, see *Artillery*, p. 68 in *Special Case Rules*.

## Arrow IV Missile Artillery System

The Arrow IV is a missile system designed to deliver long-range salvos as a supplement to conventional artillery pieces such as the Long Tom, Thumper and Sniper. The main advantage of the Arrow IV is its relatively light weight compared to other artillery, but its munitions are very expensive.

The Arrow system uses two basic types of missiles. The more common and relatively less expensive is the standard area-saturation missile, which attacks an area rather than a specific target, inflicting massive explosive damage to any object within a 45-meter blast radius.

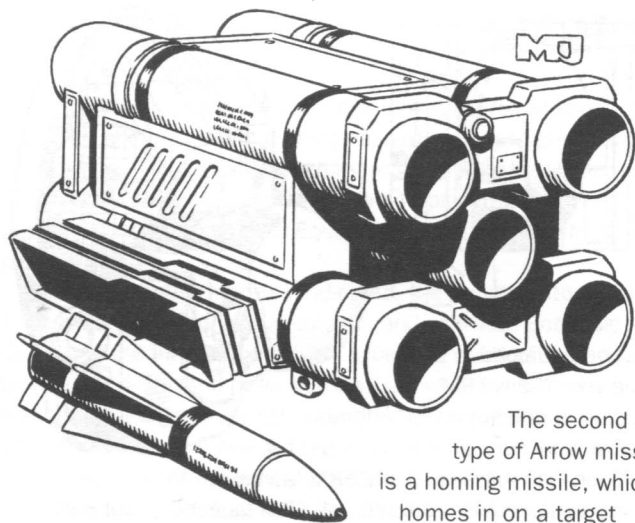

The second type of Arrow missile is a homing missile, which homes in on a target designated by a spotting

unit on the battlefield that carries target acquisition gear (TAG). The homing missile causes very little collateral damage. The Clan Arrow IV can also be used to create FASCAM minefields.

Complete rules for using the Arrow IV system can be found in the *Artillery* section, starting on page 68.

## AUTOCANNON

An autocannon is a rapid-firing, auto-loading weapon that fires high-speed streams of high-explosive, armor-piercing shells. Light autocannon range in caliber from 30 to 90mm, and heavy autocannon may be 80 to 120mm or larger.

Autocannon are also available in advanced LB-X and Ultra versions.

### LB-X Autocannon

An improvement on the common autocannon, the LB-X makes use of light, heat-dissipating alloys to reduce weight and heat buildup. These materials make the weapon more expensive than the standard autocannon, but its advantages outweigh the higher cost.

Note that the LB-X series of autocannon is not available in an Ultra configuration, and it cannot make use of that autocannon type's doubled firing rates.

**Cluster Munitions:** The LB-X autocannon can fire cluster munitions, which act like an anti-BattleMech shotgun in combat. When fired, the ammunition fragments into several smaller submunitions. This improves the attacker's chances of striking a critical location but disperses total damage by spreading hits over the target area rather than concentrating the damage on one location. Cluster munitions can be used only in LB-X autocannon, not in standard or Ultra autocannon types.

Before the start of play, the player should designate any LB-X ammunition as either standard or cluster munitions. Ammo must be designated in full-ton lots. When declaring an attack with an LB-X, the player must announce the type of ammo being used and mark it off his record sheet accordingly.

For LB-X attacks made with cluster munitions, apply a -1 modifier to the to-hit number at all ranges. Resolve successful

attacks with cluster rounds like a missile hit, with the player rolling 2D6 and consulting the column of the Missile Hits Table that corresponds to the size of his LB-X autocannon to see how many submunitions strike the target. Roll a separate location for each hit, each of which causes 1 point of damage.

When firing cluster munitions, LB-X autocannon cannot be used to make aimed shots, and they also lose the benefits of the firing unit's Clan targeting computer (if any).

### Ultra Autocannon

The advanced autocannon known as "Ultras" are capable of a higher sustained rate of fire than standard or LB-X autocannon.

A player firing an Ultra autocannon must specify whether it is firing at a normal or double rate of fire. If firing normally, all standard combat rules apply. If firing at a double rate, use the following special rules.

An Ultra autocannon firing at a double rate generates twice as much heat and uses 2 shots of ammunition instead of 1. If the standard to-hit roll is successful, the player rolls on the "2" column of the Missile Hits Table to determine how many shots struck the target. Roll separately for a hit location for each attack; each hit inflicts the full amount of damage possible for an autocannon of the size used. Both shots must be fired at the same target.

If a player is using the double rate of fire and rolls a result of 2 on his to-hit roll, the autocannon's arming circuitry fails, making the weapon useless until repaired after the battle. For repair purposes, the autocannon is considered to have suffered 1 critical hit.

**Targeting Computer:** If the firing unit is using a Clan targeting computer to aim at a specific hit location, and both shots hit, both shots hit the targeted location.

## C<sup>3</sup> COMPUTER

Only Inner Sphere units can use the Command/Control/Communications (C<sup>3</sup>) computer system. Intended for installation in command or reconnaissance 'Mechs or vehicles, the C<sup>3</sup> system is designed to help unit commanders coordinate activities on the lance and company levels.

The C<sup>3</sup> computer system links up to four units together in a communications network. The command 'Mech or vehicle must carry the "master" C<sup>3</sup> computer system, which takes up 5 tons and 5 critical slots. Each other 'Mech or vehicle linked to the network must carry a "slave" C<sup>3</sup> computer system, which takes up 1 ton and 1 critical slot. Each unit linked to a C<sup>3</sup> computer can use the targeting system of any other unit in the network. To make an attack using the C<sup>3</sup> computer system, calculate the to-hit number using the range to the target from the network's unit nearest the target with line of sight. Use the firing unit's modifiers for movement, terrain effects, minimum range, and so on. A weapon attack made using the C<sup>3</sup> system must conform to standard LOS restrictions and cannot fire beyond its maximum range, though a well-placed lancemate may allow the firing 'Mech to use his weapon's short-range to-hit number at long range.

# EQUIPMENT

The C<sup>3</sup> system itself has no maximum range, but only units actually on the map can benefit from the system, and the master unit must be on the map.

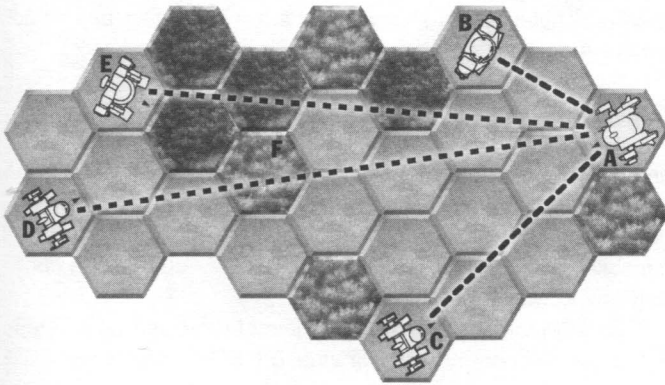

The BattleMech in Hex A is facing enemy 'Mechs in Hexes B, C, D, and E, who are connected to a C<sup>3</sup> network. The BattleMech in Hex B is the closest to the enemy, at a Range of 2. The 'Mech in Hex C can attack as though he were at a Range of 2, provided the weapons he fires have a maximum range of 4 or more. The 'Mech in Hex D can also fire as though at a Range of 2, but he must still add the terrain modifier for firing through the Light Woods in Hex F. The BattleMech in Hex E cannot attack the 'Mech in Hex A because no line of sight exists between the two units.

Prior to the start of play, designate which units are part of the network. Only three slave units can tie into a single C<sup>3</sup> master computer, so a typical network would be the four 'Mechs of a lance. However, the network can be extended by connecting the C<sup>3</sup> master computer in the command 'Mech of each lance in a company to a C<sup>3</sup> master computer carried by the company command 'Mech. This allows any 'Mech in the company to use the computer's coordinating effects. The complexity required to coordinate actions using this system limits any network to twelve 'Mechs, even when the network is extended by additional command vehicles. (In general practice, this means that each command computer network consists of three lances of four 'Mechs each, with a master computer and three slave computers assigned to each lance, and then two of the lance commanders slaved to the third lance commander (the company commander) who therefore has two master computers. The lance commanders do *not* require slave units to connect into this network, as the master computers they already carry can

handle the job.) Different networks cannot share coordinating abilities during a battle. For example, 'Mechs of Warren's Company could not use a 'Mech of Ching's Company as a target designator even if both companies had C<sup>3</sup> networks. Loss or destruction of a unit carrying a C<sup>3</sup> master computer, or a critical hit to the master computer itself, eliminates the portion of the network it controlled.

In the diagram below, each circle represents a unit and each box encloses a lance. Each "S" represents a C<sup>3</sup> slave. Each "M" represents a C<sup>3</sup> master. The arrows show the network links radiating out from the master units. Destruction of slave units has no effect on the overall network (the affected slave unit simply drops out of the network). However, destruction of a master unit will eliminate all the links pointing away from it.

Company-sized networks can be arranged in the two ways shown. The first represents the most common arrangement, with a single unit carrying two master computers and coordinating its own lance as well as the entire company. The second example shows a separate unit in the command lance carrying the computer that links the master units together in the company network. Though in theory a single unit can carry three or four master computers, the resulting increased vulnerability of the entire network makes this useless in practice.

## STANDARD CONFIGURATION

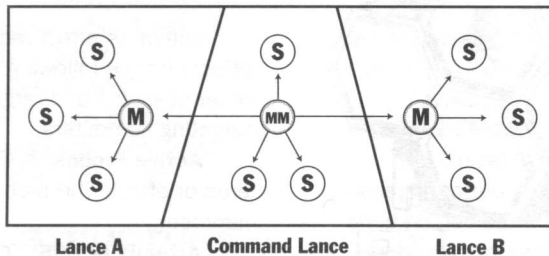

## ALTERNATE CONFIGURATION

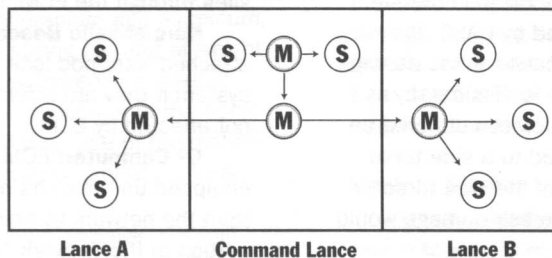

**TAG:** The C<sup>3</sup> master unit (but not the slave units) also duplicates the function of target acquisition gear (TAG; see p. 134) and can designate a target for Arrow IV homing missiles or semiguided LRMs.

**LRM Indirect Fire:** C<sup>3</sup>-equipped units spotting targets for or launching LRM indirect fire use those rules (see p. 80), and gain no benefit from the C<sup>3</sup> system.

## CARGO SPACE

During construction of any vehicle, a player may devote tonnage to cargo space. This tonnage is considered enclosed and protected by the armor of the unit. The unit may carry any cargo or infantry weighing up to this tonnage without penalty.

When the armor protecting the location occupied by the cargo is destroyed, the cargo itself is destroyed at a rate of 1 ton per point of damage to the internal structure of the location. If the vehicle is destroyed, all the cargo it was carrying is also destroyed (for exceptions see *Infantry Carriers*, p. 59).

Units can drop their cargoes. During the Movement Phase, the player may declare that his unit is dumping its cargo, then

spend 1 MP to do so. If the hauling unit is at ground level, the dropped cargo simply remains in the hex in which it was dropped. If the hauling unit is flying above ground level, the cargo takes normal falling damage and lands in the hex above which it was dropped.

**BattleMechs:** BattleMechs cannot allocate internal space to cargo, but they may carry unprotected cargo per the rules for cargo carriers, p. 72 in *Special Case Rules*.

## CELLULAR AMMUNITION STORAGE EQUIPMENT (CASE)

CASE is a damage-control technology that mitigates the effects of internal ammunition explosions. When ammo explodes in a location protected by CASE, the force of the explosion blows out through specially designed panels and armor, directing the main force of the explosion away from the BattleMech's vital components, such as the cockpit or the engine.

If ammo (or any other explosive component, such as a Gauss rifle) in a CASE-equipped location explodes, it damages the internal structure in that location; then the excess damage simply dissipates—the damage does not transfer to an additional internal structure location. Remember that the loss of all internal structure in a side torso location also blows off the corresponding arm, though the arm is not damaged by the explosion.

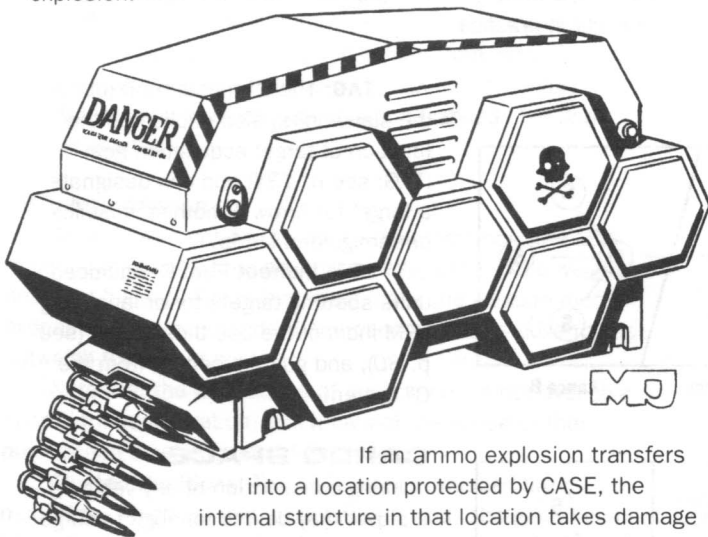

If an ammo explosion transfers into a location protected by CASE, the internal structure in that location takes damage as normal. All excess damage is dissipated, as above.

For example, if an Inner Sphere BattleMech suffered an arm ammo explosion and damage transferred to a side torso equipped with CASE, the internal structure of the side torso would suffer damage as normal, then the excess damage would harmlessly blow out the CASE panels.

An Inner Sphere CASE system requires 1 critical slot and weighs half a ton per location protected.

In Clan units, all locations containing explosive ammunition or equipment automatically have CASE, at no cost in tonnage or critical slots. Inner Sphere 'Mechs and vehicles can have CASE built in. Inner Sphere BattleMechs can only carry CASE in torso locations; Clan BattleMechs may carry CASE in any location.

**Criticals:** Critical hits on slots occupied by CASE have no effect and should be rerolled.

**Vehicles:** In vehicles, the CASE system blows out the rear armor in the event of Ammo/Power Plant critical hit; the vehicle itself is crippled, but the crew members, passengers and cargo survive the explosion.

## ECM SUITE

The Guardian ECM suite is a broad-spectrum jamming and electronic countermeasure device designed to reduce the effectiveness of enemy long-range scanning and surveillance equipment. The Clans also use an ECM suite with the same capabilities in a lighter and smaller package. A unit can mount only one ECM suite.

An ECM suite has an effect radius of 6 hexes that creates a "bubble" around the carrying unit. The ECM's disruptive abilities affect all enemy units inside this bubble, as well as any line of sight traced through the bubble. It has no effect on units friendly to the unit carrying the ECM.

*In the diagram below, the 'Mech in Hex A is equipped with an ECM Suite, which has an effect radius of 6 (shown as the shaded area). Any enemy unit in this area or enemy LOS traced through it is affected. Therefore, the 'Mech in Hex B is affected because it falls inside the radius. A shot from Hex C to Hex D would also be affected because the LOS passes through the radius. A shot from Hex C to Hex E would not be affected, however, because the LOS does not pass through the radius.*

Within its effect radius, an ECM suite has the following effects on the following systems. The ECM suite does not affect other scanning and targeting devices, such as TAG and Clan targeting computers.

**Active Probes:** Active probes cannot penetrate the ECM's area of effect. The probing unit would notice that it is being jammed.

**Artemis IV FCS:** ECM blocks the effects of the Artemis IV FCS. Artemis-equipped launchers may be fired as normal missiles through the ECM, but the Missile Hits Table bonus is lost.

**Narc Missile Beacon:** Missiles equipped to home in on an attached Narc pod lose the Missile Hits Table bonus for that system if they are affected by ECM. The Narc launcher itself is not affected by ECM.

**C<sup>3</sup> Computer:** ECM has the effect of "cutting off" any C<sup>3</sup>-equipped unit from its network. If a C<sup>3</sup> master unit is isolated from the network by being inside the ECM radius, the entire portion of the network "below" it is effectively shut off (all units subordinate to it on the diagram on p. 124). Only those C<sup>3</sup> units that can draw an LOS to the master unit that does not pass into or through the ECM radius can access the network. If the master unit that connects the lances of a company is inside the ECM effect radius, the link between the lances is lost, though each lance's network would function normally (unless the ECM also interfered with them individually).

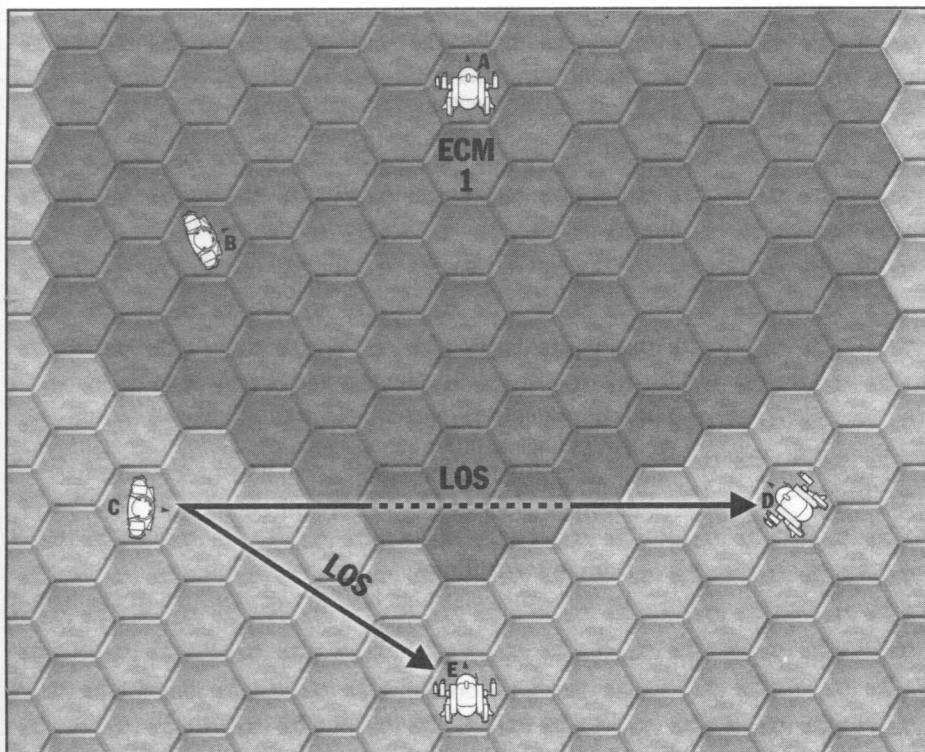

Using the illustration for the C<sup>3</sup> computer, p. 124, the situation would be quite different if the BattleMech in Hex A were equipped with an ECM suite. The 'Mechs in Hexes B and C would be cut off from the network because they are within 6 hexes of the unit. The 'Mech in Hex D is still connected to the network, but it cannot use firing data from the cut-off units or the 'Mech in Hex E, which has no LOS. Furthermore, if the C<sup>3</sup> command unit is carried by either of the 'Mechs in Hexes B or C, the entire network would collapse until they could destroy or move away from the ECM-equipped unit.

## ENDO STEEL INTERNAL STRUCTURE

Endo steel was designed especially for use in BattleMech skeletons. Using zero-G manufacturing techniques that uniformly mix high-density steel with lower-density titanium and aluminum, the process produces a metal twice as strong per unit of weight as standard skeleton materials, but at an increase in overall bulk. The Clans have refined endo steel production to the point of great efficiency, but the Successor States' use of the material is still severely hampered by the scarcity of orbital manufacturing facilities.

BattleMechs built with endo steel need allocate only half the standard weight to the internal structure (rounding up to the nearest half ton), but the bulk of the alloy takes up 7 critical slots in Clan 'Mechs and 14 in Inner Sphere BattleMechs. The player may allocate these slots wherever he sees fit, even filling up whole locations if desired, but the indicated number of slots must be filled by the endo steel.

**Criticals:** Critical hits against an endo steel critical slot have no effect and should be rerolled.

**Vehicles:** Vehicles may not use endo steel structure.

## FERRO-FIBROUS ARMOR

Ferro-fibrous armor is an improved version of ordinary BattleMech and vehicle armor that uses woven fibers of ferro-steel and ferro-titanium to greatly increase its tensile strength. However, like endo steel skeletons, ferro-fibrous armor is bulkier than standard armor plating of equivalent weight.

Units that use ferro-fibrous armor carry more Armor Points for the same weight. Calculate the normal number of Armor Points, then multiply this number by 1.12 (for Inner Sphere units) or by 1.2 (for Clan units), rounding to the nearest whole number (round .5 down). The result is the number of Armor Points of ferro-fibrous armor. To account for the bulk of the armor, place ferro-fibrous armor in 7 critical slots for Clan 'Mechs and 14 for Inner Sphere 'Mechs.

**Criticals:** Critical hits against slots filled by ferro-fibrous armor have no effect and should be re-rolled.

**Vehicles:** Vehicles may use ferro-fibrous armor, but it reduces the number of items they can mount according to the *Vehicle Space Limits* rule, p. 118. Inner Sphere ferro-fibrous armor reduces the number of items available by 2, while the Clan version counts as 1 item.

## FLAMERS

The typical flame thrower carried by 'Mechs taps into the heat generated by the fusion reactor to create a powerful but short-ranged burst of fire. These weapons are rarely mounted on 'Mechs due to their poor heat-to-damage ratio, but they can be useful incendiary weapons.

Under normal circumstances, a flamer does not cause heat damage to a target. However, if all players agree, they may choose (each time the unit fires) to add 2 to the target BattleMech's Heat Scale for that turn as a result of the flamer attack, rather than doing 2 points of damage.

### Vehicle Flamer

The so-called vehicle flamer uses ammunition supplied by fuel in tanks rather than tapping into the fusion reactor. As such, it is considered a ballistic rather than energy weapon. This means vehicles need not mount heat sinks to dissipate the heat generated by vehicle flamers, making them ideal weapons for use on internal combustion-powered units. Despite the weapon's name, BattleMechs may also mount this type of flamer, but they must accommodate the heat generated by firing the weapon using heat sinks in the usual way.

## GAUSS RIFLE

The Gauss rifle uses a series of magnets to propel a projectile through the rifle barrel toward a target. While it requires a great deal of power to operate, this weapon generates very little heat and can achieve a muzzle velocity twice that of any conventional weapon.

**Criticals:** Gauss rifle ammunition consists of a slug of nickel-ferrous metal. If a location containing Gauss ammunition takes a critical hit, the ammo does not explode, but the hit destroys the ammo-feed mechanism, rendering the rest of the ammunition in that slot useless. A critical hit on the Gauss rifle itself destroys the capacitors that power the weapon, causing a catastrophic discharge of the capacitor's stored energy, with results identical to an ammunition explosion. If a Gauss rifle takes a critical hit, treat the result as a 20-point ammunition explosion in the location containing the rifle.

**Heat:** Excess heat does not cause a Gauss rifle or its ammunition to explode.

### Light Gauss Rifle

The light Gauss rifle was developed by the Free Worlds League during its attempts to duplicate the Clan Gauss rifle's lightweight construction. The weapon itself massed the same as the Clan design, but the nickel-ferrous ammunition was only half the size of conventional Gauss-rifle ammunition. However, the weapon was able to fire these "light" shells faster and farther than conventional rounds, increasing the weapon's range and, though halving the weight of the shell, not (quite) halving the damage potential.

The light Gauss rifle follows the standard rules for Gauss rifles, except that the capacitor discharge following a critical hit on the weapon causes only 16 points of damage.

## HATCHET

Some Inner Sphere BattleMechs come equipped with hatchets. Like other weapons, hatchets account for part of a BattleMech's weight and take up one or more locations on the Arm section of the Critical Hit Table. To use the hatchet, a BattleMech must have a functioning hand actuator in the arm in which the hatchet is mounted.

A BattleMech uses a hatchet to make physical attacks per the standard club attack rules, but it can make this attack with

only one arm, rather than the two needed to swing a club. Though a BattleMech may mount two hatchets, one in each arm, it can only make one hatchet attack per turn. Weapons mounted on the arm not carrying the attacking hatchet may be fired in the turn's Weapon Attack Phase. Hatchets weigh 1 ton for each 15 tons, or fraction thereof, of the BattleMech's total weight. Hatchets take up 1 critical slot for each ton that they weigh.

Only Inner Sphere BattleMechs are known to mount hatchets; the Clans consider physical combat to be dishonorable.

## HEAT SINKS

Heat sinks are devices designed to protect an engine and other components from heat buildup by shedding a certain amount of engine- and weapons-generated heat. Standard heat sinks dissipate 1 point of heat per turn; double heat sinks dissipate 2 points of heat per turn.

### Double Heat Sinks

Because they dissipate heat at twice the rate of standard heat sinks, double heat sinks cool a BattleMech much more efficiently. Though they weigh the same as standard heat sinks, the double versions are considerably bulkier, taking up extra space aboard a BattleMech. The Clan version of the double heat sink takes up twice the room of standard sinks, while the Inner Sphere model is three times as bulky.

Single and double heat sinks cannot be mixed in any unit.

**Vehicles:** Vehicles cannot carry double heat sinks.

## LASER

Laser is an acronym for "Light Amplification by Stimulated Emission of Radiation." When used as a weapon, a laser damages its target by concentrating extreme heat on a small area. BattleMech lasers are designated as micro, small, medium and large.

Lasers are also available in extended-range (ER) versions. These types of lasers offer longer range, but at a considerably higher cost in heat.

### Heavy Lasers

After almost a century of technological stagnation, Clan scientists have finally achieved a breakthrough in laser weapon development, pioneered by Clan Star Adder. They dramatically increased the barrel and crystal size of standard lasers while improving heat efficiency and intensity. The result, the so-called heavy laser, has effective ranges equivalent to Inner Sphere lasers, but inflicts twice the damage of those antiquated weapons.

All that firepower comes at a price, however. The Star Adders achieved the increased beam intensity at the expense of all other considerations. Warriors who use the new lasers report that their cockpit monitors are plagued with static every time the weapons are fired. Apparently, poor shielding of the laser emitters—one of the many sacrifices made by the designers—allows interference with nearby electromagnetic fields.

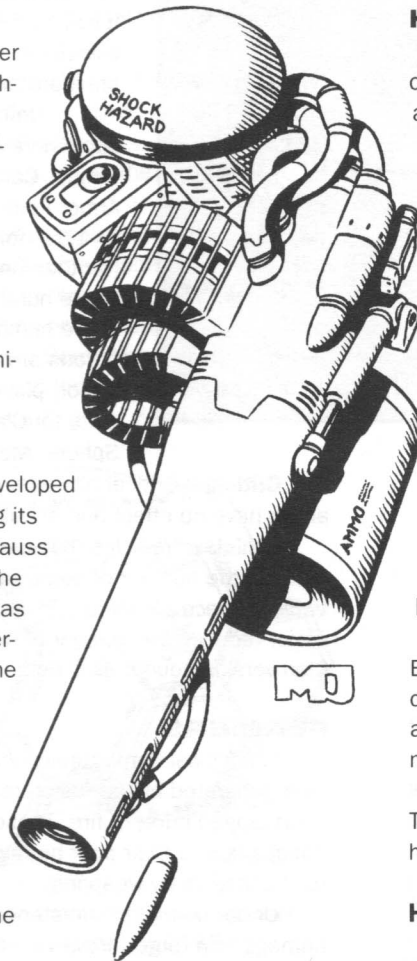

# EQUIPMENT

Heavy lasers are used in the same way as standard lasers, except add a +1 modifier to the base to-hit number for attacks made with these weapons to reflect the interference they cause in cockpit systems. This interference has no other game effect.

## Pulse Lasers

The pulse laser uses a rapid-cycling, high-energy pulse to generate multiple laser beams, creating an effect comparable to machine-gun fire. This design improves the hit probability of laser attacks and causes more damage per hit, though at a cost of increased heat and a somewhat shorter effective range.

Treat pulse lasers the same as standard lasers, but apply a -2 modifier to the base to-hit number.

## MACHINE GUN

Though rarely carried by BattleMechs, the high rate of fire produced by machine guns makes them excellent anti-infantry weapons.

## Heavy Machine Gun

The Clans have developed a higher-caliber machine gun that inflicts increased damage, but at a 33 percent reduction in effective range.

## Light Machine Gun

The light machine gun represents another advancement from the Clans. This weapon has twice the range of standard machine guns, but its lower-caliber shells inflict only half the damage.

## MISSILE LAUNCHERS

Missile launchers are devices used to deliver self-propelled and self-guided munitions to inflict damage on a target.

## Long-Range Missiles (LRM)

Long-range missile racks fire indirect salvos of high-explosive missiles at distant targets. Because of the way they are fired, LRMs suffer penalties when trying to hit targets near the firing unit. Clan versions of the LRM systems are very light and do not suffer from the minimum range problems that affect Inner Sphere LRMs.

## Medium-Range Missiles (MRMs)

MRMs evolved to fill the need for cheap, easily produced weapons that could be used effectively by the hordes of green warriors flooding the ranks of the Draconis Combine Mustered Soldiery (DCMS). Initially, many observers considered MRMs a giant step backward in weapons development. Originally dubbed "dead-fire missiles" or "dummy rockets," MRMs are unguided missile systems. Like machine guns and lasers, these missiles are aimed at a target "over iron sights." Though this configuration makes MRMs less accurate than guided missile systems, the lack of targeting systems and steering thrusters dramatically reduces the size of each missile. Consequently, a standard-sized MRM launcher holds far more missiles than a comparably sized LRM rack.

Resolve MRM attacks in the same way as LRM attacks, with the following exceptions. First, apply a +1 modifier to the base to-hit number of the MRM attack. Second, when determining missile hits for an MRM-30 or MRM-40 rack, roll twice on the standard Missile Hits Table, p. 31. For an MRM-30, roll on the "15 missiles" column twice and add the results together. For an MRM-40, roll twice on the "20 missiles" column and add the results. Determine hit location per standard LRM rules.

*Charlie fires a salvo from his MRM-40 at Bill's 'Mech and scores a hit. To determine damage, Charlie makes two 2D6 rolls and obtains results of 9 and 6. Checking the 20-missiles column on the Missile Hits Table, he finds that his launcher successfully hit with 16 and 12 missiles, for a total of 28 missiles.*

MRMs may not be fired indirectly using the LRM Indirect Fire special-case rule. While MRMs can be installed as one-shot (OS) launchers, they cannot be upgraded or combined with any other special equipment or enhancements such as Artemis IV fire-control systems, Thunder or Swarm missiles, or Narc missile beacons. Torpedo and inferno MRMs do not exist.

## Short-Range Missiles (SRM)

SRMs are direct-trajectory missiles with high-explosive or armor-piercing explosive warheads. They are accurate only at ranges of less than 300 meters but are more powerful than LRMs. Clan SRM systems are lighter and more compact than the Inner Sphere models, but otherwise function identically.

## Single-Shot Missile Launchers

Vehicles and BattleMechs sometimes carry a single-shot version of a standard missile launcher. Such a system is designated by "OS" (one-shot) following the missile nomenclature, such as LRM-20 (OS). Any type of missile weapon can be single-shot, including SRMs, MRMs, LRMs, Narc missile beacons and torpedoes.

The player does not purchase any ammunition for this launcher because it can be fired only once during the game. The single-shot missile launcher can be fitted to use special munitions, such as Swarm or Thunder LRM rounds, by increasing the base cost of the launcher by the multiple for the ammo type (see *Costs*, p. 136) rather than increasing the cost of the ammo (because ammo is not sold separately). All other performance characteristics are the same as for multi-shot launchers of the same type and ordnance.

Single-shot launchers weigh half a ton more than the standard missile launcher of the same type.

## Streak Short-Range Missiles

A Streak SRM missile contains a targeting device that prevents the missile from launching unless the missile has locked on to a target. Once locked on, the missile automatically hits its target.

A player attempting to lock a Streak missile on target must make a standard to-hit roll during the Weapon Attack Phase as if

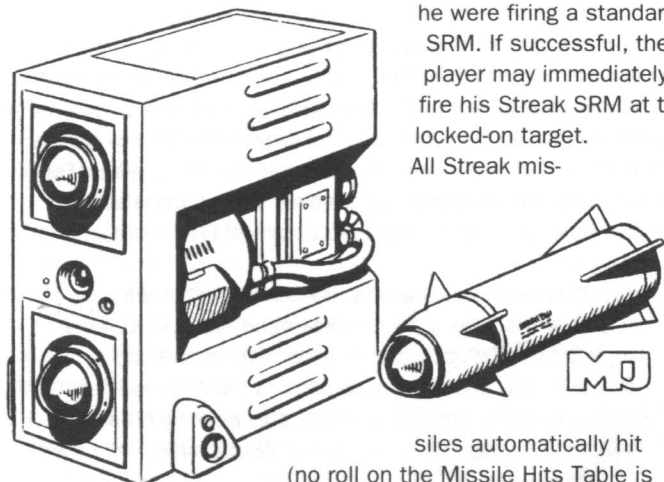

he were firing a standard SRM. If successful, the player may immediately fire his Streak SRM at the locked-on target. All Streak mis-

siles automatically hit (no roll on the Missile Hits Table is required), and the player rolls as normal to

determine the hit locations. If the roll fails, the player fails to achieve a lock and so does not fire the SRMs and does not build up any heat.

The player must roll for a targeting lock each turn, even if he achieved a lock on the target in the previous turn. The player must make a separate to-hit roll for each individual Streak system being fired.

## Torpedoes

Torpedoes are maritime versions of regular short- and long-range missiles. Torpedo stats are the same as the stats of their land-based counterparts. However, torpedoes may only be fired by a unit in a Water hex of Depth 1 or greater, against a target in a Water hex of Depth 1 or greater, and LOS must be traced through Water hexes of Depth 1 or greater. Units equipped with torpedo racks may not use normal missile ammo, and missile racks may not use torpedo ammunition. Likewise, torpedo racks may not use any type of special munitions.

For more on underwater combat, see *Underwater Operations*, p. 88 in *Special Case Rules*.

## MISSILE MUNITIONS

Long-range and short-range missile launchers can be loaded with several types of special munitions to obtain a variety of effects. The munitions types listed below can only be used in standard SRM or LRM launchers, unless otherwise noted in the rules for each item. They do not require special launchers to use them. Weapons that require special launchers are listed as their own weapon system elsewhere in this section (such as Streak SRMs), and those systems may not make use of these munitions.

Note that no launcher may combine more than one special munition or other special property (Streak, Artemis, and so on) unless specifically allowed in the rules for that item.

Special munitions must be assigned in full-ton lots and clearly marked on the record sheet of the carrying unit. The type of special munition to be used must be announced during weapon attack declaration. If no announcement is made, it is assumed normal munitions are being fired.

**Infantry:** Unless specifically stated otherwise, no special munitions may be carried by missile-equipped conventional infantry or battle armor.

## Flare LRMs

LRM-delivered flares help diminish the disadvantages of nighttime combat on part of a battlefield (see p. 80). The flare rounds are fired at a hex rather than a unit. Apply all standard to-hit modifiers, including the terrain in the target hex and the standard -4 modifier for shooting at an immobile target. A missed shot scatters the flares like artillery (see p. 68).

Suspended by a series of parachutes, the flares illuminate the hex struck and all hexes within a 3-hex range of the target hex. Targets in this illuminated area may be engaged without applying the usual +2 modifier for night combat. The illumination begins in the turn following the launch and lasts for a number of turns equal to the size of the LRM launcher divided by 5. A flight fired from an LRM-5 lasts 1 turn, a flight from an LRM-10 lasts 2 turns, and so on.

## Fragmentation Missiles

Designed to scatter large amounts of shrapnel over a wide area, fragmentation rounds are purpose-designed anti-infantry weapons. The storm of shrapnel released when one of these shells bursts can easily wipe out any unarmored troops within 15 meters of the blast. These rounds have little effect on armored targets like BattleMechs or armored vehicles.

Against all infantry targets except battle-armored troops, double the amount of damage inflicted by fragmentation missiles (before applying any modifiers). Against other targets, reduce the damage to 0.

Fragmentation missiles are available for standard SRM and LRM launchers.

## Incendiary LRMs

Players can use incendiary missiles to start fires in any suitable terrain. Rather than the usual 9+ for determining fires (p. 74), the Target Number to start fires is 5+. Incendiary rounds otherwise operate like normal LRMs.

Unlike most types of special munitions, a ton of ammunition can combine the incendiary characteristic and one other, such as semiguided or Swarm; in this case, treat the launcher as one size smaller when calculating the number of missiles that strike a target on the Missile Hits Table on p. 31. For example, roll for an LRM-20 as if it were an LRM-15. LRM-5 launchers cannot combine ammo types as their damage would be reduced to 0. Also, certain types of special munitions obviously cannot be incendiary, such as Thunder, or flare.

The chemicals used in incendiary rounds are volatile and prone to explode if exposed to high heat. To simulate this, make additional rolls to check for ammo explosions per standard *Inferno* rules, p. 131. If the incendiary rounds cook off, the entire magazine explodes. In such a case, treat the incendiary rounds as normal LRM munitions.

# EQUIPMENT

## Infernos

Infernos are special-purpose SRMs designed to affect the heat level of enemy BattleMechs. Instead of impacting on a target, an inferno round explodes in midair, dispersing a highly flammable fluid over the target area. Infernos may be used against BattleMechs and vehicles, but they may not be used directly against any sort of infantry. Infernos may be used to start fires in hexes.

All players must agree on the use of infernos in a scenario or game before play begins. Infernos must be used in conjunction with the rules for fire found on p. 74 of *Special Case Rules*.

Any unit with a standard SRM launcher, and SRM-equipped infantry (but not battle armor) can carry inferno munitions. To make an attack using inferno missiles, make a standard to-hit roll. If the attack fails, the target hex is set on fire (see below),

but it has no other effect.

The heat level of a BattleMech hit by an

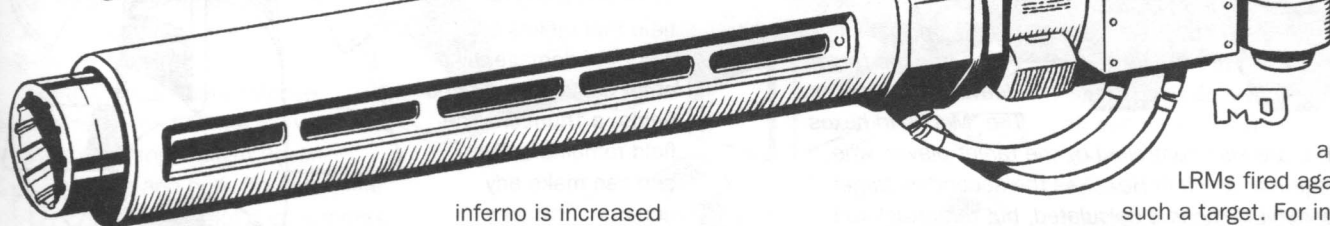
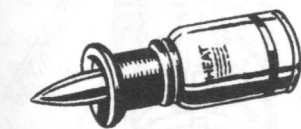

inferno is increased by 6 points during the Heat Phase.

Because the fluid sticks to the BattleMech's armor, this effect lasts for 3 turns, for a total heat buildup of 18 points.

Vehicles hit by an inferno attack must roll 2D6 in the Heat Phase of each of the 3 turns during which the fluid is burning. On a result of 8 or higher, the vehicle remains operational; any lower result means the vehicle is destroyed.

The hex that the target occupies is on fire whether or not the attack hit the target, and regardless of the terrain type. Rough, Water and Clear hexes are considered on fire for the rest of that turn and 3 more turns. Woods and Building hexes are on fire and burn normally.

Additional inferno missiles hitting the same BattleMech or target hex only prolong the effect of the first hit. Thus, if two infernos hit a BattleMech, the target would suffer a heat buildup of +6 for 6 turns rather than 3.

BattleMechs that take a hit from an inferno missile may stop the heat buildup by moving into water of Depth 2+ (or by going prone in Depth 1 water). Doing so rinses the flaming gel from the BattleMech and stops the heat build-up. However, the surface of the Water hex catches on fire and will remain on fire for the rest of that turn and 3 more turns.

**Buildings:** A unit occupying a Building hex hit by one or more infernos is affected normally by the infernos. The building is set on fire, but does not absorb any of the effect of the infernos.

**Infantry:** An SRM infantry platoon that hits its target does so with a number of inferno missiles equal to its normal damage divided by 2 (round fractions down).

**Heat:** BattleMechs that carry infernos must make an additional set of Heat Scale Avoid rolls to determine whether or not the inferno ammo explodes per the Inferno Ammo Explosion Table. The inferno Avoid rolls at 19, 23 and 28 must be made in addition to the normal Avoid rolls required at these heat levels. If inferno ammo explodes, it adds 30 points of heat to the 'Mech, along with the standard damage from an SRM 2 explosion.

## Semiguidded LRMs

Only Inner Sphere units can use Semiguidded LRMs. Semiguidded LRMs use recent advances in target designation to home in on a target successfully designated by a TAG system (see p.134). Normal modifiers for target movement do not

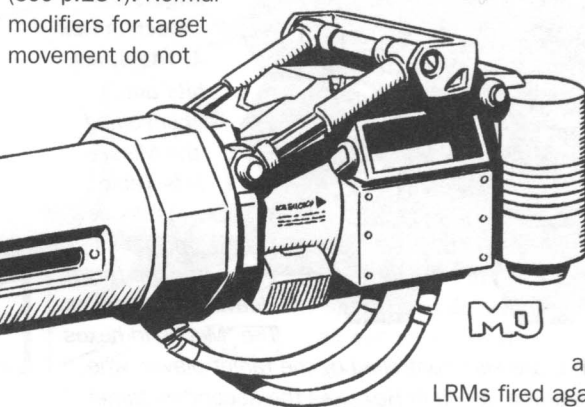

apply to LRMs fired against such a target. For indirect

LRM attacks, normal penalties for indirect fire and spotter movement do not apply. All other standard modifiers apply as usual, including penalties for the attacker's movement and for intervening terrain (if applicable).

## INFERNO AMMO EXPLOSION TABLE

Heat Level	Avoid Number
10	4+
14	6+
19	8+
23	10+
28	12

## Swarm LRMs

Swarm LRMs are missiles that deploy multiple guided submunitions that are aimed at a primary target and also attack nearby units.

Fire and resolve damage for Swarm LRMs in the same way as for normal

missiles, except that any Swarm missiles that miss their target attack any unit, friendly or enemy, in the same hex or any hex adjacent to the target. Calculate a modified to-hit number for the new target based on the same modifiers as the original attack, except for the target movement and the terrain in the hex the target occupies, which are replaced by the modifiers for the new target. The firing unit need not have a valid line of sight to the secondary target. If two or more possible secondary targets are adjacent to the original target, the player controlling the original target chooses which one is attacked. If units from both sides lie equally close to the original target, choose a target randomly.

## EQUIPMENT

When determining the number of missiles that hit a secondary target, compare the number of remaining missiles to the Missile Hit Table and use the column for the same or fewer missiles.

If missiles remain after the secondary target is hit, a new secondary target is chosen as though the secondary target was the original target. Repeat the process until all missiles have hit something or no more targets remain. However, any given unit can only be targeted once by a given Swarm salvo.

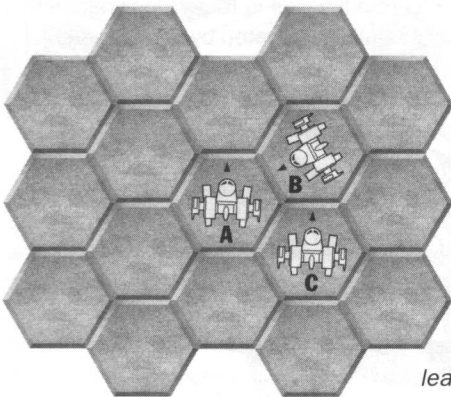

A Swarm LRM-20 salvo targets the 'Mech in Hex A. The attack hits and, consulting the Missile Hits Table, results in 9 missiles hitting the target, leaving 11 missiles. The 'Mechs in hexes

B and C are also controlled by the target player, who chooses the 'Mech in Hex C as the secondary target. A new to-hit number is calculated, but the attack roll misses. The 11 missiles could now target the 'Mech in Hex A or B, except that the missiles have already targeted the 'Mech in Hex A, so they must target the 'Mech in Hex B. This time, the to-hit roll is successful. Rolling on the 10 column of the Missile Hits table (the next smallest column under 11), 6 missiles hit the target. There are 5 missiles left ( $20 - 9 - 6 = 5$ ), which would continue on if there were any valid targets adjacent to the 'Mech in Hex B. Because both of the adjacent 'Mechs have already been a target of that salvo, the attack ends.

### Swarm-I LRMs

Like conventional swarm rounds, the improved Swarm-I deploys multiple smaller rounds that strike a primary target and any nearby units. Normal swarm rules, p. 131, apply, with the following exception. Swarm-I LRMs incorporate an IFF (Identification: Friend or Foe) detector system to reduce the chance of missiles targeting friendly units. To simulate this, add a +2 modifier to any friendly unit targeted by Swarm-I missiles, making the missiles less likely to hit that target. BattleMech units with critically damaged sensors—and therefore damaged IFF systems—do not receive this modifier.

**ECM:** Swarm-I LRMs function like conventional Swarm missiles while within range of an active enemy ECM suite.

### Thunder LRMs

Thunder LRMs deliver a spread of submunitions to the target hex, creating a minefield in that hex. A Clan Arrow IV launch-

er can deliver FASCAM (Field Artillery Scatterable Mines) munitions (see *Artillery*, p. 68).

Thunder LRMs attack hexes, rather than units. Modify the to-hit roll for these attacks by intervening terrain and the attacking unit's movement and condition only, never by the movement or condition of units in the target hex or for firing at an immobile target. If the attack misses the target hex, it scatters per the artillery rules, p. 68 of *Special Case Rules*. The hex hit by a Thunder LRM attack is considered mined by a conventional minefield from that point on. The Damage Value varies according to the size of the LRM launcher. An LRM-15 will lay a field that does 15 damage, while an LRM-5 lays a field that inflicts 5 points of damage. Like other conventional minefields, a Thunder minefield remains active and can make any number of attacks throughout the game, unless cleared (see *Clearing Minefields*, p. 81 in *Special Case Rules*).

A unit that occupies a hex during the same round that hex is targeted with a Thunder LRM is not subject to a mine attack upon leaving the hex. Because the unit's pilot or crew can easily see where the missile scatters its mines, the unit may safely exit the hex.

A Thunder LRM cannot deliver a command-detonated or vibrabomb field.

Add together the damage of multiple Thunder minefields in the same hex, but the total Damage Value in a hex cannot be greater than 20 (except for Clan Arrow IV FASCAM, which delivers a 30-point minefield).

### MYOMER ACCELERATOR SIGNAL CIRCUITRY (MASC)

MASC allows a BattleMech to put on a short burst of speed, at some risk to its fragile leg actuators. It works by boosting the signals to the myomer leg musculature, causing those muscles to contract and relax at a quicker rate than is usually possible. This increases speed, but the stress to the actuators and myomer can cause a catastrophic failure, especially after prolonged MASC use. Note that MASC only affects leg musculature.

Any BattleMech with MASC can activate the system as it declares which movement mode it will use. The player declares that he is using the MASC system and rolls 2D6. On a result of

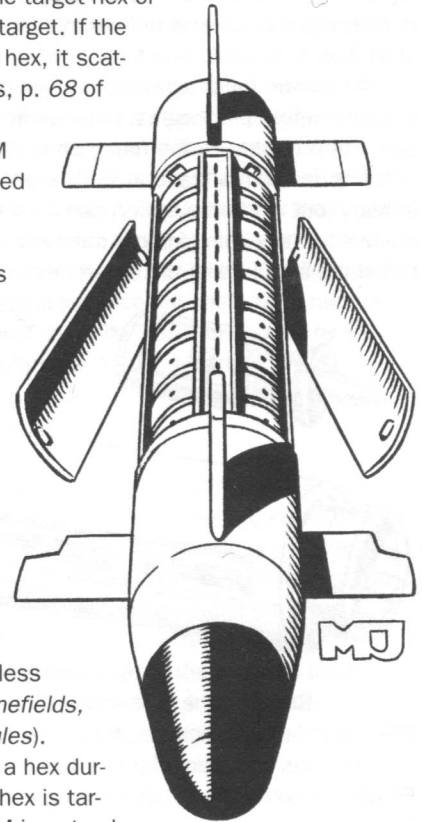

## EQUIPMENT

3 or higher, the BattleMech can run that turn at a speed equal to double its standard Walking MP. On a result of 2, the leg actuators freeze up for the rest of the game, the effects of which are identical to the 'Mech taking a critical hit to both hip actuators. Note that the 'Mech is not considered an immobile target.

The player must roll 2D6 every turn the 'Mech is using MASC to determine whether or not the system freezes up. On the second consecutive turn of MASC use, a result of 4 or less immobilizes the BattleMech. A result of 6 or less freezes the actuators on the third consecutive turn, 10 or less on the fourth, and the legs automatically fail on the fifth turn of MASC use.

For each turn the system is not used, reduce the target number at which the muscles will freeze by one interval, but never below 3. For example, a player using MASC for three consecutive turns needs a result of 7 or higher on the third turn to stay mobile. After an intervening turn of not using the system, the player would need a 5 or higher to avoid freezing up. Two turns without using MASC then reduces the threshold number to the original 3.

Both Clan and Inner Sphere BattleMechs can use MASC, with the Clans gaining a slight advantage in weight and bulk. To determine tonnage and critical slot requirements for MASC, divide an Inner Sphere 'Mech's tonnage by 20 and a Clan 'Mech's tonnage by 25. Round all fractions to the nearest whole number, rounding .5 up. The result is the amount of 'Mech tonnage that must be allocated for MASC and the number of critical slots it takes up, with a minimum of 1 ton and 1 critical slot.

MASC is incompatible with triple-strength myomer.

### NARC MISSILE BEACON

The Narc missile beacon is a heavily modified missile launcher that fires special missiles, called pods, made up of powerful homing beacons mounted behind a magnetic head. If the missile hits its target, the pod broadcasts a homing signal for any friendly missile systems equipped to receive Narc transmissions. Like the Artemis IV system, Narc pods potentially increase the number of missiles that hit a target. The Narc system is superior to the Artemis in that the signal lock cannot be broken once established, because the beacon is attached to the target and cannot be destroyed.

Players may fire 1 Narc pod per launcher each turn. If the attack hits, the pod is attached to the target unit. In all following combat phases, any unit attacking with Narc-equipped missiles adds +2 to the result of the roll on the Missile Hits Table. This modifier remains in effect for the targeted BattleMech for the duration of the battle. Multiple Narc pods attached to a target have no additional effect. Other Narc beacons in the target hex do not confuse Narc-guided missiles.

The Narc system can be used to aid both standard SRM and LRM missile attacks. It does not affect attacks made with special munitions or launchers. Missiles capable of homing in on a beacon cost twice as much as standard missiles because they carry special guidance links.

**Criticals:** Exploding Narc ammo causes 2 points of damage per pod.

**Buildings:** Narc pods cannot be fired into or inside buildings.

**ECM:** Narc-guided missiles function like conventional missiles while within range of an active enemy ECM suite; they do not receive the +2 modifier when rolling on the Missile Hits Table.

### Narc Explosive Pods

These special munitions were created to give units equipped with Narc launchers more flexibility in using these specialized delivery systems, as well as letting them surprise opponents with unexpected firepower. The explosive pod replaces the homing beacon in the standard Narc pod with a powerful shaped charge. The charge detonates immediately after the pod attaches itself to the target, damaging the armor underneath.

Roll the hit location for an explosive pod per standard rules. Explosive Narc pods inflict 4 points of damage rather than attaching to the target, and thus do not act as beacons for Narc-guided missiles.

**Criticals:** If an ammo bin containing explosive pods takes a critical hit, the explosive pods detonate; each pod causes 4 points of damage to the 'Mech carrying them.

### PARTICLE PROJECTOR CANNON (PPC)

A PPC consists of a magnetic accelerator firing high-energy proton or ion bolts that cause damage through both impact and high temperature. PPCs are among the most effective weapons available to BattleMechs.

PPCs also come in extended-range (ER) versions, which fire at a longer range but produce considerably higher heat.

### SWORD

The BattleMech sword is a Draconis Combine version of the standard BattleMech hatchet. Most MechWarriors consider the sword less effective in combat than the heavier hatchet, but the large katana blade better fits the samurai ideal of the Combine warrior. The sword's lighter weight makes its attacks somewhat more accurate than those made with hatchets.

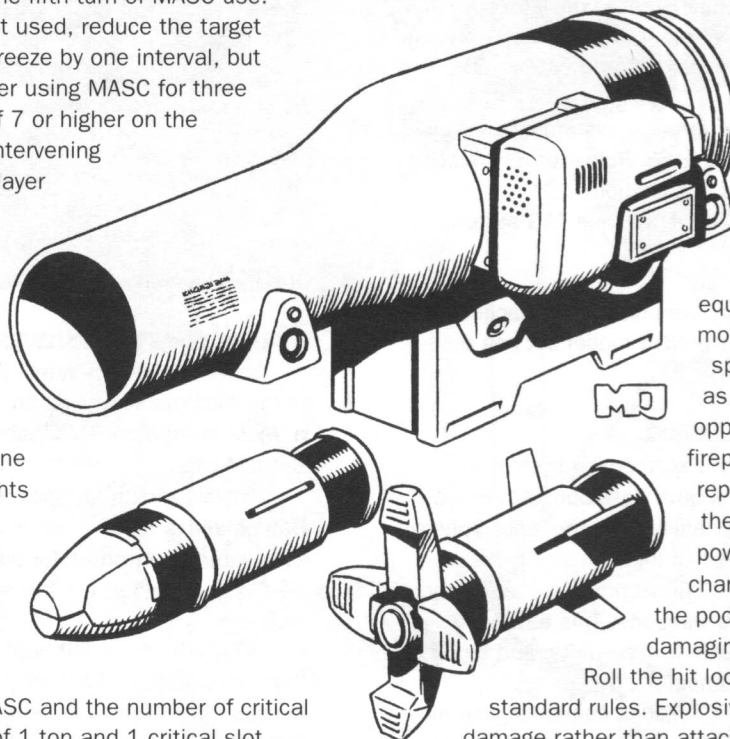

## EQUIPMENT

The sword follows standard rules for hatchets, per p. 128, with the following exceptions. First, a sword's weight is equal to the tonnage of the BattleMech carrying it divided by 20, rounded up to the nearest half ton. Swords occupy 1 critical slot for every 15 tons (or fraction thereof) the carrying BattleMech weighs. Second, the Base To-Hit Number for a sword attack is 3. Finally, to determine the damage caused by a sword attack, divide the attacking BattleMech's tonnage by 10 (round up) and add 1.

### TARGET ACQUISITION GEAR (TAG)

A spotter uses target acquisition gear to designate a target for an attack by a homing missile fired from an Arrow IV Missile Artillery System or semi-guided missiles fired from an LRM launcher.

Complete rules for using the Arrow IV system can be found in the *Artillery* section, starting on p. 68. Rules for *Semiguidded LRMs* can be found on p. 131 of this section.

Note that a given unit can mount only one TAG system.

### Light TAG

The Clans also employ a light version of target acquisition gear, which is smaller than the standard model but has a shorter effective range.

### TARGETING COMPUTER

In addition to the various special targeting systems developed for missiles, the Clans have developed advanced targeting systems, unmatched by anything in the Inner Sphere, that can enhance the performance of the following types of direct-fire weapons: lasers, PPCs, Gauss rifles, and autocannon. It has no effect on other types of weapons. This advanced targeting computer is only available to Clan units, and a unit may only mount one targeting computer.

To make an attack using the targeting computer, use all standard rules for weapons of that type, but modify the to-hit number for any attack using the unit's lasers, PPCs, Gauss rifles, and autocannon by -1.

The player may use the targeting computer to attempt to attack a specific hit location. Not all weapons linked to the targeting computer need make an aimed shot, but all weapons used for this type of attack must fire at the same location, which must be visible to the firing unit. For example, an attack on the right side of the target cannot be directed against the left arm, left leg or left torso. Add a +3 modifier to the to-hit number for all weapons used in the attack. (This modifier replaces the -1 modifier applied to standard attacks using this technology.) The head of a 'Mech may never be targeted in this manner. Note that this type of attack is not the same as an *Aimed Shot*, p. 33. If a targeting computer-aimed attack misses the desired hit location, it misses entirely.

The size and weight of an advanced targeting computer depends on the amount of direct-fire weaponry on the carrying unit. For every 5 tons or fraction thereof of lasers, PPCs, Gauss rifles and autocannons (not counting ammo) carried by the unit, the targeting computer requires 1 ton and 1 critical slot.

**LB-X Autocannon:** When firing cluster munitions, LB-X autocannons lose the benefits of the firing unit's Clan targeting computer.

**Ultra Autocannon:** If the firing unit is using a Clan targeting computer to aim at a specific hit location and both shots hit, both shots hit the targeted location.

### TSM MOVEMENT MODIFIERS

Heat Level	MP Modifier
0-4	+0
5-8	-1
9	+1
10-14	-1
15-19	-2
20-24	-3
25+	-4

### TRIPLE-STRENGTH MYOMER

Inner Sphere scientists have developed a special type of myomer "muscle" that becomes exceedingly strong when a 'Mech overheats. This technology is not available to Clan BattleMechs.

Triple-strength myomer provides a benefit only when a BattleMech is running hot. If a BattleMech is equipped with triple-strength myomer, for each turn that it ends with a heat level of 9 or higher, the following effects take place the next turn.

- Ignore the -1 MP heat effect at 5 on the Heat Scale (but apply all other heat modifiers to movement). In addition, increase the 'Mech's Walking MP by 1 and recalculate its Running MP accordingly. Triple-strength myomer does not affect Jumping MP. The Walking MP modifiers at the various heat levels are summarized on the TSM Movement Modifiers Table.

- Double the damage for punch, kick, club, and hatchet/sword attacks.

- Double the 'Mech's lifting ability (see *BattleMech Lifting Capabilities*, p. 72).

Triple-strength myomer cannot be combined with MASC and takes up 6 critical slots anywhere on the BattleMech.

**Criticals:** Critical hits against slots containing triple-strength myomer have no effect and are rerolled.

### XL ENGINES

Advances in fusion power-plant shielding have allowed engineers to retrofit standard engines with new and lighter shielding materials, greatly reducing overall engine weight, but at the cost of compactness. The Clan version of the XL engine is much less bulky than those developed so far in the Inner Sphere.

Players may designate any fusion plant as being built with XL technology. Halve the normal engine weight (rounding up to the halfton), and allocate additional engine critical slots to both the right and left torsos. Inner Sphere XL engines fill 3 critical

## EQUIPMENT



slots in each side torso, while the Clan version fills only 2 critical slots in each side torso.

**Criticals:** Note that any 3 engine critical hits destroy a BattleMech regardless of whether the critical slots are in the side or center torso.

**Vehicles:** Vehicles may use XL engines, but it reduces the number of items they can mount according to the *Vehicle Space Limits* rule, p. 118. An Inner Sphere XL engine reduces the number of items available by 2, while the Clan version counts as 1 item.

## COSTS



Players who need to buy new equipment, repair damaged units, or replace destroyed infantry must have the resources available to do so. The *Costs* section assigns a price in C-bills to all parts of a BattleMech or vehicle and replacement costs for various infantry types. (See also descriptions of individual weapons and equipment in *Equipment*, beginning on p. 122). If desired, players can "purchase" their forces using C-bills. For more information on unit purchases and maintenance, see the *BattleTech Field Manual: Mercenaries*.

### CLAN EQUIPMENT

Note that Clan equipment is not for sale through normal channels. The Clans manufacture their own equipment and distribute it to their units without the need for a monetary exchange. Therefore, prices of Clan items are included here for comparison only. If purchased, Clan equipment and units would only be found on the black market, and then certainly at a significant markup over the costs provided on this list.

### BATTLEMECH COSTS

The cost in C-bills for a custom-designed BattleMech is the sum of the cost of all components according to the formulas listed below, multiplied by the Final BattleMech Cost Multiplier (listed at the bottom of the BattleMech Costs Table). When formulas refer to tonnage, use that of the BattleMech, except for gyros and armor. For those two components, use the individual component weight. As shown on the table below, the Structural Cost of a BattleMech includes everything but its weapons, equipment and OmniMech conversion cost.

### BATTLEMECH COSTS TABLE

Structural Cost	Formula or Cost (in C-bills)
Cockpit	200,000
Life Support	50,000
Sensors	Tonnage x 2,000
Musculature	
Standard	Tonnage x 2,000
Triple-Strength	Tonnage x 16,000
Internal Structure	
Skeleton	
Standard	Tonnage x 400
Endo Steel	Tonnage x 1,600
Arm Actuators	
Upper	Tonnage x 100
Lower	Tonnage x 50
Hand	Tonnage x 80
Leg Actuators	
Upper	Tonnage x 150
Lower	Tonnage x 80
Foot	Tonnage x 120
Engine	
Standard	$(5,000 \times \text{Rating} \times \text{Tonnage}) \div 75$
XL	$(20,000 \times \text{Rating} \times \text{Tonnage}) \div 75$
Gyro	300,000 per ton of gyro
Jump Jets	Tonnage x (Number of Jets) <sup>2</sup> x 200
Heat Sinks	
Standard	2,000 per each over 10
Double	6,000 each (including 10 that come with engine)
Armor	
Standard	10,000 x tons of armor
Ferro-Fibrous	20,000 x tons of armor

### Other Costs

Weapons and Equipment	See Weapon and Equipment Prices
OmniMech	
Conversion Cost	$(\text{Weapons and Equipment Cost} + \text{Structural Cost}) \times .25$

**Final BattleMech Cost Multiplier:**  $(\text{Structural Cost} + \text{Weapons and Equipment Cost} + \text{OmniMech Cost}) \times [1 + (\text{Tonnage} \div 100)]$

## VEHICLE COSTS TABLE

Structural Costs	Formula or Cost (in C-bills)
Engine	
Standard Fusion	$(5,000 \times \text{Rating} \times \text{Tons}) \div 75$
XL	$(20,000 \times \text{Rating} \times \text{Tons}) \div 75$
ICE	$(1,250 \times \text{Rating} \times \text{Tons}) \div 75$
Control Components	$10,000 \times \text{Control Tonnage}$
Internal Structure	$10,000 \times \text{IS Tonnage}$
Heat Sinks (Standard)	2,000 each over 10, if fusion engine 2,000 each if ICE engine
Armor	
Standard	$10,000 \times \text{Tons of Armor}$
Ferro-Fibrous	$20,000 \times \text{Tons of Armor}$
Power Amplifiers	$20,000 \times \text{Amplifier Tonnage}$
Turret	$5,000 \times \text{Turret Tonnage}$
Lift/Dive Equipment (Hovercraft, Hydrofoils, Submarines)	$20,000 \times \text{Equipment Tonnage}$
Rotors (VTOLs)	$40,000 \times \text{Rotor Tonnage}$
Weapons and Equipment	See Weapons and Equipment Prices
<b>Cost Multipliers</b>	
Tracked	$1 + (\text{Tons} \div 100)$
Wheeled	$1 + (\text{Tons} \div 200)$
Hover	$1 + (\text{Tons} \div 50)$
VTOL	$1 + (\text{Tons} \div 30)$
Displacement Hull	$1 + (\text{Tons} \div 200)$
Hydrofoil	$1 + (\text{Tons} \div 75)$
Submarine	$1 + (\text{Tons} \div 50)$

## VEHICLE COSTS

To determine the cost of a custom-designed vehicle, add the cost of all components together according to the formulas listed below. When formulas refer to tonnage, use that of the component itself, except for the engines and the final cost multiplier, which use the vehicle's total tonnage. Multiply the total Structural Cost by the Cost Multiplier to find the vehicle's final cost.

## INFANTRY COSTS TABLE

Type	Cost (in C-bills)
<i>Standard Infantry</i>	
Foot Platoon	
Rifle	600,000
Machine Gun/Flamer	800,000
Portable Lasers	1,200,000
SRM	1,400,000
Motorized Platoon	
Rifle	960,000
Machine Gun/Flamer	1,280,000
Portable Lasers	1,920,000
SRM	2,240,000
Jump Platoon	
Rifle	1,200,000
Machine Gun/Flamer	1,600,000
Portable Lasers	2,400,000
SRM	2,800,000
Anti-Mech Training	5 x normal cost
<i>Clan Battle Armor: 5 troopers per Point</i>	
Standard Battle Armor Point	3,500,000
Gnome Battle Armor Point	5,250,000
Salamander Battle Armor Point	3,325,000
<i>Inner Sphere Battle Armor: 4 troopers per squad</i>	
Standard Battle Armor Squad	2,400,000
Infiltrator Stealth Battle Armor Squad	1,800,000
Sloth Assault Battle Armor Squad	1,800,000
Gray Death Light Scout Armor Squad	1,650,000
Longinus Battle Armor Squad	2,550,000
Achileus Light Battle Armor Squad	1,920,000
Kage Light Battle Armor Squad	1,850,000
Kanazuchi Assault Battle Armor Squad	3,300,000

## INFANTRY COSTS

Consult the Infantry Costs Table for the C-bill cost of an infantry platoon or a Point of battle armor.

# COSTS

## WEAPON AND EQUIPMENT PRICES

Type	Cost (unloaded)	Ammo Cost (per ton)	Type	Cost (unloaded)	Ammo Cost (per ton)
<i>Energy Weapons</i>			LRM 15	175,000	30,000
ER Laser (Large)	200,000	—	LRM 20	250,000	30,000
ER Laser (Medium)	80,000	—	MRM 10	50,000	5,000
ER Laser (Small)	11,250	—	MRM 20	125,000	5,000
ER Laser (Micro)	10,000	—	MRM 30	225,000	5,000
Flamer	7,500	—	MRM 40	350,000	5,000
Heavy Laser (Large)	250,000	—	Single-Shot Launchers	Half normal	—
Heavy Laser (Medium)	100,000	—	SRM 2	10,000	27,000
Heavy Laser (Small)	20,000	—	SRM 4	60,000	27,000
Laser (Large)	100,000	—	SRM 6	80,000	27,000
Laser (Medium)	40,000	—	Streak SRM 2	15,000	54,000
Laser (Small)	11,250	—	Streak SRM 4	90,000	54,000
PPC	200,000	—	Streak SRM 6	120,000	54,000
ER PPC	300,000	—	<i>Missile Munitions</i>		
Pulse Laser (Large)	175,000	—	Flare LRM	—	normal
Pulse Laser (Medium)	60,000	—	Fragmentation LRM/SRM	—	2 x normal
Pulse Laser (Small)	16,000	—	Incendiary LRM	—	1.5 x normal
Pulse Laser (Micro)	12,500	—	Inferno SRM	—	13,500
<i>Ballistic Weapons</i>			Semiguidded LRM	—	3 x normal
AC/2	75,000	1,000	Swarm LRM	—	2 x normal
AC/5	125,000	4,500	Swarm-I LRM	—	3 x normal
AC/10	200,000	6,000	Thunder LRM	—	2 x normal
AC/20	300,000	10,000	<i>Artillery</i>		
Flamer (Vehicle)	7,500	1,000	Arrow IV System		
Gauss Rifle	300,000	20,000	Standard	450,000	10,000
Light Gauss Rifle	275,000	20,000	Homing	—	15,000
LB 2-X			Long Tom	450,000	10,000
Standard	150,000	2,000	Sniper	300,000	6,000
Cluster	—	3,300	Thumper	187,500	4,500
LB 5-X			<i>Miscellaneous Equipment</i>		
Standard	250,000	9,000	Active Probe	200,000	—
Cluster	—	15,000	Light Active Probe	150,000	—
LB 10-X			Anti-Missile System	100,000	2,000
Standard	400,000	12,000	Anti-Personnel Pod	1,500	—
Cluster	—	20,000	Artemis IV FCS	100,000	2 x normal
LB 20-X			CASE	50,000	—
Standard	600,000	20,000	C <sup>3</sup> Master Unit	1,500,000	—
Cluster	—	34,000	C <sup>3</sup> Slave Unit	250,000	—
Heavy Machine Gun	7,500	1,000	ECM Suite	200,000	—
Machine Gun	5,000	1,000	Hatchet (per ton)	5,000	—
Light Machine Gun	5,000	500	MASC	Engine Rating x MASC Tonnage x 1,000	—
Ultra AC/2	120,000	1,000	Narc Missile Beacon	100,000	6,000
Ultra AC/5	200,000	9,000	Explosive Pods	—	1,500
Ultra AC/10	320,000	12,000	Narc-Capable Missiles	—	2 x normal
Ultra AC/20	480,000	20,000	Sword (per ton)	10,000	—
<i>Missile Launchers</i>			TAG	50,000	—
LRM 5	30,000	30,000	Light TAG	40,000	—
LRM 10	100,000	30,000	Targeting Computer (per ton)	10,000	—

## BATTLE VALUE SYSTEM



The Battle Value (BV) system provides a numerical rating—a battle value—that represents the damage capabilities and potential for survival of every *BattleTech* field unit: BattleMechs, vehicles, infantry and structures. With the Battle Value system, evenly matched battles can be created by simply assembling two opposing forces with the same total BV ratings.

The exact BV of any BattleMech, vehicle, infantry unit or structure—even scratch-built, customized and other nonstandard units—can be calculated with the formulas presented in this section. Be forewarned, however, that some of the formulas may seem overly complex, perhaps even arcane. (Unfortunately, the variety of military hardware and units available to *BattleTech* commanders cannot be accurately reflected with a simple, easy-to-use system.) A list of calculated Battle Values for all previously published BattleMechs and vehicles can be found in *Maximum Tech*.

Only equipment that affects a unit's capacity for damaging an opponent or for surviving a battle is included in these calculations: if a piece of equipment does not directly affect either of those elements, it does not figure into the Battle Value of a unit.

The capabilities of battlefield units are not the only factors that will affect the overall effectiveness of a fighting force, of course. Most notably, the terrain and size of a battlefield can have a significant impact on the effectiveness of a fighting group. For example, a 'Mech group with many long-range weapons will not be able to use those weapons to full advantage when fighting a battle that takes place on a single map-sheet. If the Battle Values of both sides are equal, but one side outnumbers the other side, the smaller force will be at a disadvantage. And most important, the skill and experience of the controlling player will always be a major factor in the effectiveness of a *BattleTech* force. Quantifying these factors in any meaningful way is virtually impossible, however, and so they are not represented in the BV system.

### CALCULATING BATTLEMECH BV

Calculating a BattleMech's BV rating involves three main steps. First, calculate the 'Mech's Defensive Battle Rating. Second, calculate the Offensive Battle Rating. Then add the Defensive and Offensive Battle Ratings to find the final BV. In all cases, retain fractions until reaching the final BV, then round to the nearest whole number. As you read each step, refer to p. 145 for an example of calculating the BV for a *Goshawk*.

The BV ratings for weapons and equipment are listed in the Inner Sphere and Clan Weapons and Equipment Battle Value Tables at the end of this section, beginning on p. 142.

#### STEP 1: CALCULATE DEFENSIVE BATTLE RATING

First, **ADD** the following figures:

**Total Armor Factor x 2**

**Total Internal Structure Points x 1.5**

(Total Internal Structure Points x 0.75 if 'Mech has an XL engine)

(Total Internal Structure Points x 1.125 if 'Mech has a Clan XL engine)

**Total 'Mech Tonnage**

**Total BV of all Defensive Equipment**

(Specifically, defensive equipment includes antimissile systems [including ammo], antipersonnel pods and ECM suites. All other weapons and equipment are considered offensive equipment.)

Then **SUBTRACT** the following figures. (Explosive ammo is any ammunition that may explode within a 'Mech. For this purpose, consider a Gauss rifle the equivalent of a ton of explosive ammo. These subtractions cannot drop the running total below 1.)

# BATTLE VALUE SYSTEM

## DEFENSIVE MOVEMENT FACTORS

Target Movement Modifier	Defensive Movement Factor
+0	1.0
+1	1.1
+2	1.2
+3	1.3
+4	1.4
+5	1.5

## SPEED FACTOR TABLE

Result of Speed Factor Calculation	Speed Factor
2	0.65
3	0.77
4	0.88
5	1.00
6	1.12
7	1.24
8	1.37
9	1.50
10	1.63
11	1.76
12	1.89
13	2.02
14	2.16
15	2.30
16	2.44
17	2.58
18	2.72
19	2.86
20	3.00
21	3.15
22	3.29
23	3.44
24	3.59
25	3.74

**20 points per ton of explosive ammo** in Center Torso, Legs or Head (Clan 'Mechs)

**20 points per ton of explosive ammo** in any location (Inner Sphere 'Mechs with XL engines)

**20 points per ton of explosive ammo** in Center Torso, Legs or Head or not protected by CASE in its location

**20 points per ton of explosive ammo** in Arm not protected by CASE in its location or next location inward on Damage Transfer Diagram

### (Maximum potential Heat Points – Heat Sink Capacity) x 5

Maximum potential Heat Points is the number of Heat Points generated if a 'Mech fires all of its weapons and moves in the most heat-intensive manner possible—Running or Jumping at its maximum capacity—during a single turn. When calculating maximum potential Heat Points, double Heat Points generated by Ultra autocannon, reduce by half Heat Points generated by Streak SRMs, and ignore Heat Points generated by rear-firing weapons.

Heat Sink Capacity denotes the maximum number of Heat Points a 'Mech's heat sinks can dissipate in a single turn. If a 'Mech's Heat Sink Capacity exceeds its maximum potential Heat Points, disregard this factor when calculating the Defensive Battle Rating.

**Rear-Mounted Weapons:** If the total BV of rear-mounted weapons is higher than the total BV of other firing arcs, consider the rear arc to be the Front and vice versa for purposes of calculating BVs.

Next, **MULTIPLY** the current value by the 'Mech's Defensive Movement Factor. A 'Mech's Defensive Movement Factor is based on the unit's highest potential Target Movement Modifier (including bonuses for jump capability and enhanced-movement capability from MASC or Triple-Strength Myomer), as shown on the Defensive Movement Factors table. The final result is the BattleMech's Defensive Battle Rating.

## STEP 2: CALCULATE OFFENSIVE BATTLE RATING

Calculating the Offensive Battle Rating is more complicated.

### Calculate Base Weapon Battle Rating

Add the BV ratings of all remaining weapons, ammunition, and equipment. Add only half the BV of rear-mounted weapons (though all ammo is worth its full BV).

Also include the BV of any targeting computer in the 'Mech.

(The BV ratings of targeting computers, C<sup>3</sup> computers and C<sup>3</sup> slaves are calculated as a percentage of the total BV ratings of all weapons linked to them. When performing these calculations, reduce by half the BV ratings of rear-mounted weapons linked to these items. See the Weapon and Equipment tables, p. 143, for more information.)

**Rear-Mounted Weapons:** If the total BV of rear-mounted weapons is higher than the total BV of other arcs, consider the rear arc to be the Front and vice versa for purposes of calculating BVs.

### Adjust the Base Weapon Battle Rating for the 'Mech's Heat Efficiency

If the 'Mech's maximum potential Heat Points exceed the 'Mech's Heat Sink Capacity, the Base Weapon Battle Rating must be adjusted. (See *Step 1: Calculate Defensive Battle Rating* for definitions of maximum potential Heat Points and Heat Sink Capacity). In effect, weapons that can-

# BATTLE VALUE SYSTEM

not be fired if the BattleMech overheats are worth half their value.

Use the following formula to adjust the Base Weapon Battle Rating:

(Total Heat Sinks X Base Weapon Battle Rating)

+ Maximum Heat Points = X

(Base Weapon Battle Rating - X) ÷ 2 = Y

X + Y = Modified Weapon Battle Rating

## Multiply the Modified Weapon Battle Rating by the 'Mech's Speed Factor

A 'Mech's Speed Factor reflects its ability to maneuver on the battlefield. To find the Speed Factor of a 'Mech, add together its Running MP and Jumping MP. Add 1 to this sum if the 'Mech has MASC or triple-strength myomer. Then consult the Speed Factor Table. Multiply the Modified Weapon Battle Rating by the Speed Factor to find the 'Mech's Offensive Battle Rating.

To calculate Speed Factors for movement not shown on the table, use the following formula:

Running MP + Jumping MP

+ 1 if the unit has MASC or triple-strength myomer

- 5 (the result may be negative if the unit is very slow)

Divide this total by 10, then add 1.

Finally, raise the total to the 1.2 power. Round this off to two decimal places.

## STEP 3: CALCULATE FINAL BV

The BV of a 'Mech is calculated by adding the 'Mech's Defensive and Offensive Battle Ratings. Round off the remaining fraction to the nearest whole number.

This formula yields the Battle Value of a BattleMech piloted by a MechWarrior with the standard Gunnery and Piloting Skill levels of Gunnery 4 and Piloting 5. If the unit is piloted by a MechWarrior with higher or lower skill levels, multiply the BV by the appropriate skill level multiplier (see *Skill/Experience Level Multipliers*, p. 144).

## CALCULATING CONVENTIONAL VEHICLE BV

The procedure for calculating a vehicle's BV is very similar to the procedure for calculating the BV of BattleMechs. The Defensive and Offensive Battle Ratings of the vehicle are determined, then combined to produce the final BV. In all cases, retain fractions until reaching the final BV, then round to the nearest whole number.

The BV ratings for weapons and equipment are listed in the Inner Sphere and Clan Weapons and Equipment BV tables at the end of this section, beginning on p. 143.

## STEP 1: CALCULATE DEFENSIVE BATTLE RATING

First, **ADD** the following figures:

### Total Armor Factor

### Internal Structure ÷ 2.

(Include the internal structure points of any turret or rotor.)

### Total BV of all Defensive Equipment

(Defensive equipment includes antimissile systems [including ammo] and ECM suites. All other weapons and equipment are considered offensive equipment.)

Next, **MULTIPLY** the current value by the appropriate Vehicle Type Modifier from the Vehicle Type Modifiers Table. A vehicle's Vehicle Type Modifier represents its terrain restrictions and vulnerability to critical damage. Surface vessels, hydrofoils, and submarines are considered Naval-type vessels for this purpose.

## VEHICLE TYPE MODIFIERS TABLE

Vehicle Type	Modifier
Tracked	0.8
Wheeled	0.7
Hover	0.6
Naval	0.5
VTOL	0.4

Now **MULTIPLY** the figure by the appropriate Defensive Movement Factor. A vehicle's Defensive Movement Factor is based on the unit's highest potential Target Movement Modifier (including bonuses for VTOL movement capability), as shown on the Defensive Movement Factors Table on p. 140. The final result is the vehicle's Defensive Battle Rating.

## STEP 2: CALCULATE OFFENSIVE BATTLE RATING

A vehicle's Offensive Battle Rating is calculated by determining the vehicle's Base Weapon Battle Rating, then multiplying the rating by the vehicle's Speed Factor.

### Calculate Base Weapon Battle Rating

First, add the BV ratings of all remaining weapons, ammunition and equipment. Add only half the BV of rear-mounted weapons (though all ammo is worth its full BV).

Also include the BV of any targeting computer in the vehicle.

(The BV ratings of targeting computers, C<sup>3</sup> computers and C<sup>3</sup> slaves are calculated as a percentage of the total BV ratings of all weapons linked to them. When performing these calculations, reduce by half the BV ratings of rear-mounted weapons linked to these items. See the Weapons and Equipment tables, p. 143, for more information.)

# BATTLE VALUE SYSTEM

**Rear-Mounted Weapons:** If the total BV of rear-mounted weapons is higher than the total BV of other arcs, consider the rear arc to be the Front and vice versa for purposes of calculating BVs.

## Multiply the Base Weapon Rating by the vehicle's Speed Factor

Multiply the vehicle's Base Weapon Rating and Speed Factor to determine its Offensive BR.

Calculate a vehicle's Speed Factor in the following manner:

Flanking MP + VTOL MP

See the Speed Factor Table on p. 140 for pre-calculated Speed Factors.

## STEP 3: CALCULATE FINAL BV

Add the Defensive and Offensive Battle Ratings and round off the resulting sum to the nearest whole number. The result is the vehicle BV.

This formula yields the BV of a vehicle controlled by a vehicle crew with the standard Gunnery and Piloting Skill levels of Gunnery 4 and Piloting 5. If the unit is piloted by a crew with higher or lower skill levels, multiply the BV by the appropriate skill level multiplier (see *Skill/Experience Level Multipliers*, p. 144).

## INFANTRY

The BV on the Infantry Battle Values table were calculated with formulas similar to those used for determining BattleMech and vehicle BV. All BVs in the table assume a standard Clan Point of 5 troopers or an Inner Sphere battle-armor squad of 4 troopers. Adjust the BV proportionally for units of nonstandard size. For example, an anti-Mech trained Clan battle-armor Point equipped with flamers has a BV of 245—that means each of the 5 troopers in the Point has a BV of 49. If the Point contained only 3 troopers, its BV would be 147 (49 x 3).

## WEAPON AND EQUIPMENT BATTLE VALUES

The following tables list the BV for Level 1 and 2 Inner Sphere and Clan weapons and equipment. Each weapon's BV is based on the potential damage and accuracy of that weapon at all ranges. Weapons that inflict heavy damage over a long range have a higher BV than weapons that inflict similar damage over shorter ranges or weapons that inflict less damage within similar ranges.

Some weapon Battle Values also reflect other factors. For example, any weapon that can inflict 12 or more Damage Points in a single location receives a boost to its BV. (Such weapons are known as "head-choppers" because they can destroy a BattleMech head with a single hit.)

BV for single-shot (OS) versions of missile launchers are listed as the second BV figure for the launcher, after the slash (/).

## INFANTRY BATTLE VALUES

Infantry Type	BV	BV (Anti-Mech Trained)
Clan Battle Armor Point (Standard)		
Flamer	—	245
Machine Gun	—	234
Small Laser	—	279
Gnome Battle Armor Point	360	—
Salamander Battle Armor Point	—	247
Inner Sphere Battle Armor Squad (Standard)		
Flamer	—	150
Machine Gun	—	141
Small Laser	—	177
SRM	—	132
Kage Light Battle Armor Squad		
Flamer	—	79
Machine Gun	—	77
Small Laser	—	88
TAG	—	63
Kanazuchi Assault Battle Armor Squad	251	—
Longinus Battle Armor Squad		
Flamer	—	168
Machine Gun	—	159
Small Laser	—	195
Achilles Light Battle Armor Squad		
Flamer	—	88
Machine Gun	—	86
Small Laser	—	95
Gray Death Light Scout Armor Squad		
Rifle/Flamer	—	63
Machine Gun	—	65
Laser/SRM	—	74
Infiltrator Battle Armor Squad	60	—
Sloth Battle Armor Squad	109	—
Foot Infantry Platoon		
Flamer	28	41
Laser	37	60
LRM	56	56
Machine Gun	31	47
Rifle	23	32
SRM	60	60
Jump Infantry Platoon		
Flamer	32	51
Laser	41	71
LRM	87	87
Machine Gun	37	62
Rifle	29	46
SRM	71	71
Motorized Infantry		
Flamer	35	54
Laser	42	70
LRM	75	75
Machine Gun	39	63
Rifle	28	42
SRM	70	70

# BATTLE VALUE SYSTEM

## INNER SPHERE WEAPONS AND EQUIPMENT BV

Item	Item BV	Ammo BV (per ton)
<i>Energy Weapons</i>		
ER Laser (Large)	163	—
ER Laser (Medium)	62	—
ER Laser (Small)	17	—
Flamer	6	—
Laser (Large)	124	—
Laser (Medium)	46	—
Laser (Small)	9	—
PPC	176	—
ER PPC	229	—
Pulse Laser (Large)	119	—
Pulse Laser (Medium)	48	—
Pulse Laser (Small)	12	—
<i>Ballistic Weapons</i>		
AC/2	37	5
AC/5	70	9
AC/10	124	15
AC/20	178	20
Flamer (Vehicle)	5	1
Gauss Rifle	321	37
Light Gauss Rifle	159	20
LB 2-X AC	42	5
LB 5-X AC	83	10
LB 10-X AC	148	19
LB 20-X AC	237	27
Machine Gun	5	1
Ultra AC/2	56	7
Ultra AC/5	113	14
Ultra AC/10	253	29
Ultra AC/20	282	32
<i>Missile Weapons</i>		
LRM 5	45/9	6
LRM 10	90/18	11
LRM 15	136/27	17
LRM 20	181/36	23
MRM 10	56/11	7
MRM 20	112/22	14
MRM 30	168/34	21
MRM 40	224/45	28
SRM 2	21/4	3
SRM 4	39/8	5
SRM 6	59/12	7
Streak SRM 2	30/6	4
Streak SRM 4	59/12	7
Streak SRM 6	89/18	11
<i>Artillery Weapons</i>		
Arrow IV System	171 <sup>A</sup>	11
Long Tom	171	11
Sniper	86	5
Thumper	40	3

Item	Item BV	Ammo BV (per ton)
<i>Other Equipment</i>		
Anti-Missile System	32	11
Anti-Personnel Pod	1	—
Artemis IV FCS	B	—
Beagle Active Probe	10	—
CASE	C	—
C <sup>3</sup> Computer (Master)	D	—
C <sup>3</sup> Slave	D	—
Guardian ECM Suite	61	—
Hatchet	(Damage x 1.5)	—
MASC	C	—
Narc Missile Beacon	30/6	0
Sword	(Damage x 1.725)	—
TAG	A	—
Triple-Strength Myomer	C	—

### NOTES

<sup>A</sup> **Arrow IV System/TAG:** Add 200 points to the final BV of any battlefield unit that meets the following conditions: the unit is equipped with an Arrow IV system and homing missiles and the unit—or the unit's fighting group—has one or more units with TAG; or the unit is equipped with TAG and the unit—or the unit's fighting group—has one or more Arrow IV systems with homing missiles.

<sup>B</sup> **Artemis IV FCS:** Increase by 20 percent the BV of any missile launcher equipped with Artemis IV. This increase does not apply to the launcher's ammunition.

<sup>C</sup> **CASE/MASC/Triple-Strength Myomer:** Though these items are used when calculating the Defensive Battle Rating, they have no individual BV.

<sup>D</sup> **C<sup>3</sup> Computers/Slaves:** C<sup>3</sup> Computers and Slaves only have BV if the unit's fighting group has a complete C<sup>3</sup> network (at least one C<sup>3</sup> Master and one Slave; see p. 124 for details). In this case, increase the final BV of each battlefield unit in the network by an amount equal to 35 percent of the total BV of all its weapons. Do not include the BV of ammo, defensive equipment or artillery weapons in this calculation. Also, use half the BV ratings of rear-mounted weapons when calculating the total. Round the final result to the nearest whole number.

## CLAN WEAPONS AND EQUIPMENT BV

Item	Item BV	Ammo BV (per ton)
<i>Energy Weapons</i>		
ER Laser (Large)	249	—
ER Laser (Medium)	108	—
ER Laser (Small)	31	—
ER Laser (Micro)	7	—
Flamer	6	—
Heavy Laser (Large)	243	—
Heavy Laser (Medium)	76	—
Heavy Laser (Small)	15	—
ER PPC	412	—
Pulse Laser (Large)	265	—
Pulse Laser (Medium)	111	—
Pulse Laser (Small)	24	—
Pulse Laser (Micro)	12	—

# BATTLE VALUE SYSTEM

## BV SKILL MULTIPLIERS

Gunnery Skill	Piloting Skill							
	0	1	2	3	4	5	6	7
0	2.05	2.00	1.95	1.90	1.85	1.80	1.75	1.70
1	1.85	1.80	1.75	1.70	1.65	1.60	1.55	1.50
2	1.65	1.60	1.55	1.50	1.45	1.40	1.35	1.30
3	1.45	1.40	1.35	1.30	1.25	1.20	1.15	1.10
4	1.25	1.20	1.15	1.10	1.05	<b>1.00</b>	0.95	0.90
5	1.15	1.10	1.05	1.00	0.95	0.90	0.85	0.80
6	1.05	1.00	0.95	0.90	0.85	0.80	0.75	0.70
7	0.95	0.90	0.85	0.80	0.75	0.70	0.65	0.60

Item	Item BV	Ammo BV (per ton)
------	---------	-------------------

### Ballistic Weapons

Flamer (Vehicle)	5	1
Gauss Rifle	321	33
Heavy Machine Gun	6	1
Machine Gun	5	1
Light Machine Gun	5	1
LB 2-X AC	47	6
LB 5-X AC	93	12
LB 10-X AC	148	19
LB 20-X AC	237	33
Ultra AC/2	62	8
Ultra AC/5	123	15
Ultra AC/10	211	26
Ultra AC/20	337	35

### Missile Weapons

LRM 5	55/11	7
LRM 10	109/22	14
LRM 15	164/33	21
LRM 20	220/44	27
SRM 2	21/4	3
SRM 4	39/8	5
SRM 6	59/12	7
Streak SRM 2	40/8	5
Streak SRM 4	79/16	10
Streak SRM 6	119/24	15

### Artillery Weapons

Arrow IV System	171 <sup>A</sup>	11
Long Tom	171	11
Sniper	86	5
Thumper	40	3

### Other Equipment

Active Probe	12	—
Light Active Probe	7	—
Anti-Missile System	63	21
Anti-Personnel Pod	1	—
Artemis IV FCS	<sup>B</sup>	—
CASE	<sup>C</sup>	—
ECM Suite	61	—
MASC	<sup>C</sup>	—

Item	Item BV	Ammo BV (per ton)
------	---------	-------------------

Narc Missile Beacon	30/6	0
TAG	<sup>A</sup>	—
Light TAG	<sup>A</sup>	—
Targeting Computer	<sup>D</sup>	—

### NOTES

<sup>A</sup> **Arrow IV System/TAG/Light TAG:** Add 200 points to the final BV of any battlefield unit that meets the following conditions: the unit is equipped with an Arrow IV system and homing missiles and the unit—or the unit's fighting group—has one or more units with TAG; or the unit is equipped with TAG and the unit—or the unit's fighting group—has one or more Arrow IV systems with homing missiles.

<sup>B</sup> **Artemis IV:** Increase by 20 percent the BV of any missile launcher equipped with Artemis IV. This increase does not apply to the launcher's ammunition.

<sup>C</sup> **CASE/MASC:** Though these items are used when calculating the Defensive Battle Rating, they have no individual BV.

<sup>D</sup> **Targeting Computer:** The BV of a Targeting Computer equals 20 percent of the total BV of all weapons linked to the computer. Do not include the BV of ammo when calculating the sum, and use half the BV ratings of rear-mounted weapons.

## SKILL/EXPERIENCE LEVEL MULTIPLIERS

The BV calculations and BV in the provided tables represent the BV of battlefield units piloted by units with skill levels of Gunnery 4 and Piloting 5. If the unit has higher or lower skill levels, adjust the final BV of the unit. Find the multiplier that corresponds to the unit's skill levels on the BV Skill Multipliers Table. (Note that infantry units have no Piloting Skill; simply use the 5 column of the table.) Then multiply the unit BV by the multiplier.

Apply the skill multiplier only after all other appropriate modifiers have been applied to the unit's BV.

# BATTLE VALUE SYSTEM

## CALCULATING THE BATTLE VALUE OF A GOSHAWK

### Calculating the Defensive Battle Rating

Total Armor Factor x 2:  $173 \times 2 = 346$   
 Total Internal Structure Points x 1.125:  $91 \times 1.125 = 102.375$   
 Total 'Mech Tonnage:  $55$   
 Total BV of all Defensive Equipment:  $0$

**503.375**

20 points per ton of explosive ammo in Center Torso,  
 Head or Legs:  $0$

(Maximum potential Heat Points - Heat Sink Capacity) x 5:  
 $(30 - 22) \times 5 = 40$

**40**

**503.375**

**-40**

**463.375**

At a full jump, the Goshawk presents a Target Movement  
 Modifier of +3. That gives the 'Mech a *Defensive Movement*  
*Factor of 1.3.*

**463.375**

**x 1.3**

**Defensive Battle Rating = 602.3875**



### 3.) Multiply the Modified Weapon Battle Rating by the 'Mech's Speed Factor

#### Calculate Speed Factor

Running MP + Jumping MP:  $9 + 6 = 15$   
 + 1 if the unit has MASC or Triple-Strength Myomer:  $+ 0$

**15**

**Speed Factor = 2.30**

Modified Weapon Battle Rating x Speed Factor = Offensive  
 Battle Rating:  $713.3533334$   
 $\times 2.30$

**1,640.72667**

**Offensive Battle Rating = 1,640.72667**

### Calculating the Final Battle Value

Defensive Battle Rating + Offensive Battle Rating = BV:  
 $602.3875 + 1,640.72667 = 2,243.100167$

**Goshawk BV = 2,243**

### Calculating the Offensive Battle Rating

#### 1.) Calculate Base Weapon Battle Rating

Large Pulse Laser:  $265$   
 Three Medium Pulse Lasers:  $333$

**598**

Targeting Computer for lasers:  $(598 \times 0.2) = 119.6$

Four Machine Guns:  $20$

with 1/2 ton of ammo:  $0.5$

Two Streak SRM-2s:  $80$

with 1 ton of ammo:  $5$

**Base Weapon Battle Rating = 823.1**

#### 2.) Adjust the Base Weapon Battle Rating for the 'Mech's Heat Efficiency

(Total Heat Sinks x Base Weapon Battle Rating) ÷ Maximum  
 Heat Points = X:  $(22 \times 823.1) \div 30 = 603.6066667$

(Base Weapon Battle Rating - X) 2 = Y:  
 $(823.1 - 603.6066667) \div 2 = 109.7466667$

X + Y = Modified Weapon Battle Rating:  
 $603.6066667 + 109.7466667 = 713.3533334$

**Modified Weapon Battle Rating = 713.3533334**

## RULES CHANGES

Though the text of the *BattleTech Master Rules* has been extensively reformatted and clarified, it contains the same rules as the previous edition, the *BattleTech Compendium: The Rules of Warfare (BTC:RoW)*. Some rules changes were made, however, based on continuing player feedback and testing. In all cases, the goal was to improve game play without making existing sources (such as record sheets and Technical Readouts) obsolete.

For the convenience of existing *BattleTech* players, all significant rule changes are summarized below. [The developer's reasons, in brief, for making each change are included in brackets.]

**Note:** The descriptions below are only general summaries of the rule changes. Players are urged to turn to the appropriate sections and read the entire rule in its proper context.

### PLAYING THE GAME

#### Reaction Phase

The Reaction Phase has been eliminated. Torso and turret twists are now declared at the same time as weapon attack declaration (p. 13). [Very few players actually used the Reaction Phase, and when they did, it considerably bogged down game play.]

#### MechWarriors

The rules for Skill Improvement have been changed to be fairer and simpler to adjudicate (p. 14). [Another rule seldom used, mainly because players could not agree on which 'Mech should score a "kill." And when they could, too often the lucky guy who sneaked in and scored the kill got the points, instead of the guy who did most of the damage.]

### MOVEMENT

#### Skidding

Units that skid now skid in a straight line based on their momentum rather than moving forward 1 hex on their new path before beginning the skid. The distance of the skid has been reduced by half. A unit in the path of a skidding unit that has not yet moved in the turn can attempt to get out of the way (p. 21). [The way skids were resolved has always confused players, primarily because it does not match physics. In addition, skidding used to be a "cheap" way to Charge an enemy before he moved, an action that was normally impossible.]

### WEAPON ATTACKS

#### Multiple Targets Modifier

Multiple targets no longer all need to be in the forward arc. Those inside the forward arc receive a +1 modifier, while those outside the forward arc receive a +2 modifier (p. 30). [The prohibition against firing at targets in front of you and behind you in the same phase made rear-mounted weapons virtually useless.]

#### Aimed Shots

Aimed shots against the head now strike it on a 2D6 roll of 6, 7, or 8, just like other aimed shots, rather than 8+ (p. 33). [This change was made for consistency. The odds remain virtually the same, but now all Aimed Shots work the same way.]

#### BattleMech Critical Hits

Critical hits inflicted against a location that was just destroyed do transfer (p. 35). [This rule makes sense and should have been part of the game before this. This change also helps streamline the damage resolution process.]

Leg destruction reduces Walking MP to 1 and the unit cannot run. [This is another clarification.]

#### BattleMech Critical Hit Effects

An ammunition critical hit only explodes the ammo carried in the slot hit, not all the ammunition in the location (p. 36). [This clarification came from the definition of the terms *location* and *slot*.]

An Arm Blown Off critical hit does not destroy the equipment mounted in the arm, but rather knocks it free of the 'Mech (p. 36). [Another rule that should have existed before this, based on the clarification of the term *destroyed*.]

A life support critical hit causes the pilot to take damage if the 'Mech is submerged or in a vacuum (p. 37). [This just makes sense, based on what life support does for the 'Mech. It also makes a life support critical hit a more serious effect, whereas before it had very little meaning for game play.]

### PHYSICAL ATTACKS

#### Pushing

A push attack may only be made against a target directly in front of the attacker's feet (p. 40). [This precludes the need for any sort of free facing changes or sidestep movement after the push.]

#### Kicking

The to-hit numbers and damage for a kicking attack are now modified for damaged actuators in the same way as a punching attack is modified (p. 40). [This rule just makes sense, based on the rationale for punch modifiers.]

#### Charging

A BattleMech cannot make a charging attack against a prone BattleMech, though a vehicle can (p. 41). [This change is based on the way a charging attack is executed. A charge just doesn't seem logical between two 'Mechs in such different physical positions. Also, a kick is a safer bet for a 'Mech attack against a prone 'Mech.]

# RULES CHANGES

## Death From Above

The to-hit number is modified for the relative Piloting Skills of the attacker and target in the same way as for a charging attack (p. 42). [This change is one that many players requested; it also makes sense based on the charging attack rules].

Every unit no longer has LOS to a 'Mech executing a death from above attack. For the purposes of LOS, the attacking 'Mech is treated as though it is standing in the air 1 level higher than the target hex (pp. 42-43). [Another player request, based on the "reality" of the situation. Hey, things are already hard enough on a 'Mech doing a DFA.]

## HEAT

### Recording Heat Buildup

Though it has no additional effects, a 'Mech's heat level can now rise above 30 (p. 46). [This change is to discourage mega-overheating "strategies." Many were the home-brew designs that would pack on as many ER PPCs as possible, with virtually no heat sinks. The idea is that you fire everything, shut down for one turn, and then you're back in business. Now, if you build up 100 heat, you have to get rid of 71 of it before you can start up again.]

## BUILDINGS

### Damage to Units Inside

A building now absorbs damage from each attack that hits a unit inside it, rather than per attacker (pp. 51-52). [This rule was confusing and unclear as to what portion of the damage was absorbed and from what attacker.]

### Collapse

Each hex of a multihex building or bridge can support total tonnage equal to its current CF (p. 52). [It just makes sense. Very large buildings and bridges were too fragile under the previous rules.]

## VEHICLES

### Naval Movement

Unlike other units, naval units can move at Flank speed while on the surface of Water hexes (p. 56). [This is really a clarification.]

### VTOL Combat

The normal Attacker Movement Modifiers are applied to VTOL units, rather than the +3 modifier for jumping. Attacks against VTOLs that expend movement are modified as though the target was jumping (p. 57). [Another player request. VTOLs are so vulnerable to damage, the extra penalty to their to-hit numbers made them almost useless except as spotters.]

## INFANTRY

### Combat

Infantry units now have Gunnery Skill levels like all other units and make attacks in the same way (p. 60). [A change made for consistency; this helps facilitate varying skill levels among infantry units.]

### Infantry Carriers

Battle armor weights have been increased to 1 ton per trooper (p. 59). [This change is in line with the fictional description of battle armor.]

### Inner Sphere Power Suits

The Infiltrator battle armor is no longer limited to four shots (p. 66). [This change was made to bring the Infiltrator more in line with other infantry units.]

## SPECIAL CASE RULES

### Anti-BattleMech Infantry

A BattleMech being swarmed may intentionally drop prone to shake off the infantry, but this requires a successful Piloting Skill Roll. If the BattleMech goes prone, it takes damage as from an accidental fall (p. 67). [This one just made sense. Swarm attacks are nasty enough, and it seemed silly that a 'Mech could not choose to drop prone if it was swarmed.]

### Artillery

What constitutes onboard and off-board has been defined, and the target number for onboard attacks is now based on the attacker's Gunnery Skill (p. 68). [This is basically a clarification.]

### Basements

A collapsed basement creates a sinkhole under the building of the appropriate depth. Vehicles trapped in basements must follow the standard LOS procedures, and can move out of a 1-level deep basement per normal movement rules (p. 53). [This is a clarification made for ease of play.]

### Clearing Woods

After a successful to-hit roll, a wooded hex is only converted on a 2D6 roll equal to or less than the damage inflicted by the attack (p. 72). [Woods hexes were simply too easy to clear.]

### Dumping Ammunition

Ammunition is dumped per critical slot, not per location (p. 73). [The clarification of terminology for *location* and *slot* resulted in this change.]

### Fire

Missed shots against targets in Woods hexes can set accidental fires, but no longer have a chance to clear the woods (p. 74). [This straightens out the discrepancy between weapon types that can start fires and weapon types that can clear woods, and simplifies the accidental fire procedure.]

# RULES CHANGES

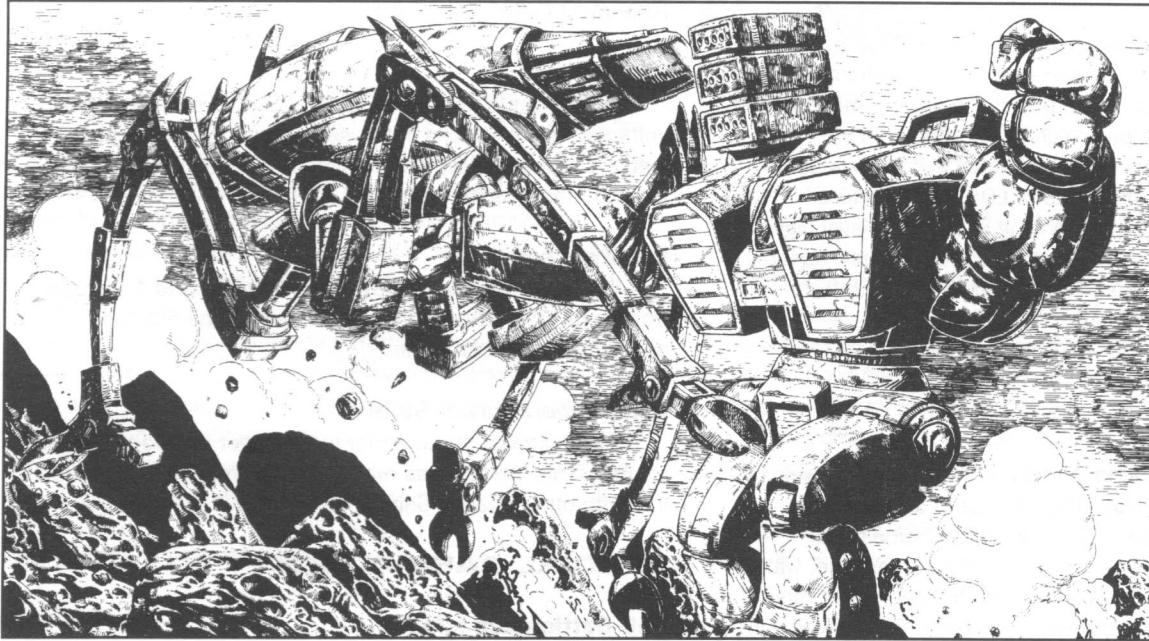

Smoke is now two levels high (p. 75). [Now smoke actually affects game play.]

## Four-Legged BattleMechs

The rules for quads have been amended to better reflect their unique stature (p. 75). [Quads have always suffered due to their lack of internal space. By adding a few more restrictions and bonuses to their special abilities, they are now more distinct from two-leggers, and hopefully more interesting to play.]

## Hostile Environments

Skidding on ice now works the same way as other types of skidding (p. 78). [This is another change made for consistency and ease of play.]

## Scavenging and Repair

The Scavenging and Repair rules have been thoroughly upgraded and expanded (p. 82). [Another frequent player request. We "borrowed" these rules from the well-received repair rules in *Maximum Tech*.]

## CONSTRUCTION

### BattleMechs

BattleMechs lighter than 20 tons can no longer be constructed (p. 109). [FASA has never published a 'Mech under 20 tons and the rules as written don't really work for units that light. Players commonly use these rules to exploit the charging rules by creating excessively fast, light 'Mechs.]

The Inner Sphere now has access to OmniMech technology (p. 120). [This change is in line with developments in the fiction.]

## Vehicles

### Modular

OmniVehicles can now be created (p. 120). [This change is in line with developments in the fiction.]

## EQUIPMENT

An assortment of new Level 2 equipment has been added to this chapter from recent products, including the *Field Manuals* and *Maximum Tech*. These new items are not considered rules changes. Only those items that were in the *BTC:RoW*

and have changed significantly are discussed below.

## Anti-Missile System

The rules for resolving anti-missile fire have been altered to make them a bit more useful and a bit simpler to use (p. 122). [This item has been a long-time source of confusion and consternation among many players.]

## Anti-Personnel Pods

These items are now available to the Inner Sphere (p. 123). [It was only a matter of time before this simple system was adopted by the Inner Sphere.]

## Infernos

Infernos may now be carried in any size SRM launcher, but they may not be used in Streak launchers (p. 131). [The fact that infernos could only be loaded in 2-packs never made much sense. Now they are treated like all other special munitions, which also restricts them from Streak launchers.]

## Myomer Acceleration Signal Circuitry

The use of MASC is announced at the start of the unit's movement, rather than the start of the Movement Phase (p. 132). [If used the way it was originally written, the utility of the item is greatly reduced. Besides, most players appear to use it according to the revision we present in this book, rather than the way the rule has been presented in the past.]

## BATTLE VALUE SYSTEM

The Battle Value Skill Multipliers Table (p. 144) from *Maximum Tech* has been modified. [This change is a response to continued playtesting and player feedback.]

## INDEX

- A**
- Achilles armor, 65-66
  - Aimed shots, 31, 33, 48, 146
  - Ammunition, 113-14, 119-20
    - critical hits and, 36
    - dumping, 73, 147
    - expenditure, 27
    - explosions, 15
    - heat effects on, 48
    - missile, 130-32
  - Anti-BattleMech infantry, 61, 67-68, 147
  - Anti-missile system, 122-23, 148
  - Anti-personnel pods, 123, 148
  - Armor
    - addition, 113
    - diagram, 9, 10
    - repair, 83
    - vehicle, 119
  - Arms reversal, 81-82
  - Arrow IV missile artillery system, 71-72, 123-24
  - Artemis IV fire-control system, 123
  - Artillery, 68, 70-72
    - flak, 75
    - miniatures rules, 96
    - modifiers table, 70
    - onboard fire, 71
    - smoke rounds, 71
    - table, 71
    - weapons, 123-24
  - Attacker movement modifier, 29
  - Attacks
    - declaration of, 25
    - location after, 42
    - modifiers table, 32
    - miniatures rules, 96
  - Autocannon, 124
- B**
- Backward movement, 17, 19
  - Basements, 53
    - table, 52
  - Base to-hit number, 43
  - Battle armor, 59-61
    - Clan variants, 61-63
    - infantry, 9
  - BattleMechs, 7-8
    - assigning, 103, 105-8
    - battle value calculations for, 139-41
    - construction of, 109-11
    - costs, 136
    - critical hits to, 35-38, 146
    - critical space for, 109
    - data sheet for, 9
    - destruction of, 38
    - lifting capabilities of, 72
    - punch location table for, 39
    - record sheets for, 9-10
    - shutdown effects on, 47-48
  - Battle value, 108
    - BattleMech calculations, 139-41
    - infantry, 142
    - skill/experience level multipliers, 144
    - vehicle calculations, 141-42
    - weapons and equipment, 142-44
- Bidding**, 103
- Bridges**, 12
  - maximum capacity of, 21
  - miniatures rules for, 92
  - movement and, 21
- Buildings**, 12
  - artillery damage to, 71
  - basements table for, 52
  - collapse of, 52-53
  - combat and, 25, 51-53
  - construction factor for, 49-50
  - default value, 49
  - entering, 50-51
  - fire and, 74, 131
  - gun emplacement in, 53
  - hit location for, 33
  - intervening, 26
  - levels, 51
  - modifiers table for, 50
  - movement effects by, 50-51
  - movement modifiers table for, 50
  - stacking and, 20
  - types of, 49-50
- C**
- C<sup>3</sup> computer, 124-25
  - Cargo carriers, 72
  - Cargo space, 125-26
  - CASE (cellular ammunition storage equipment), 126
  - Charge attacks, 41-42
  - Clans
    - BattleMech assignment table for, 107
    - force composition for, 103
    - weapons and equipment for, 116-17, 143-44
  - Clearing woods, 147
  - Clear terrain, 11
  - Club attacks, 40
  - Cluster munitions, 124
  - ComStar, force composition, 103
  - Consciousness rolls, 16
  - Construction
    - of BattleMechs, 109-11
    - critical space, 109, 112-14
    - customizing, 87
    - of four-legged BattleMechs, 75
    - of vehicles, 118-20
  - Costs
    - BattleMech, 136
    - infantry, 137
    - replacement table, 83
    - vehicle, 137
    - weapons and equipment, 138
  - Counters, 12
  - Cover, partial, 26, 30, 95
  - Crashing, VTOL, 55
  - Crew survival, 38
  - Critical damage, 19, 35-38, 40-41
  - Critical hits
    - anti-missile system, 123
    - Artemis, 123
    - BattleMech, 35-38
    - CASE, 126
    - endo steel, 127
  - ferro-fibrous armor, 127
  - Gauss rifle, 128
  - Narc missile beacon, 133
  - naval table, 57
    - table, definition of, 10
    - triple-strength myomer, 134
    - vehicles table, 56
    - VTOL, 58
    - XL engine, 135
  - Customization, 87-88
- D**
- Damage
    - recording, 33-34
    - resolution, 34
    - transference, 34-36
  - Death from above, 71
  - Default skill levels, 14-15
  - Dice, 12
  - Domino effect, 20, 45
  - Dropping to ground, 20
  - Dropping troops, 72-73
- E**
- ECM suite, 126-27
  - Ejection, 73-74
    - modifiers table, 73
  - Elevation, 11
    - change, 17
    - change, backward movement, 17
    - combat and, 25
    - miniatures rules, 94
    - target and physical attack, 44
  - Endo steel, 110, 127
  - Energy weapons, 120
  - Engine
    - critical hit, 36
    - rating, 111-12, 119
    - replacement of, 83
  - Experience level, 108
  - Explosive components, 38
- F**
- Facing, 17-18
    - change, 19
    - after a fall table, 24
  - Falling, 15, 22, 24, 42, 44
    - accidental from displacement, 45
    - BattleMech damage from, 24
    - MechWarrior damage from, 24
    - miniatures rules for, 94
    - swarming and, 68
    - weapon attack phase and, 43
  - Ferro-fibrous armor, 127
  - Fire, 12
    - accidental, 74
    - effects of, 74-75
    - intentional, 74
    - spreading, 75
    - swarming and, 68
  - Firing arc, 27-28
    - miniatures rules, 95
    - rotating, 28
  - Firing when down, 77
  - Flak, 75

# INDEX

- Flamers, 127  
Foot infantry, 9  
Four-legged BattleMechs, 75, 77  
Fusion engine table, 111
- G**  
Game, ending, 97  
Gravity, high/low, 78-79  
Ground vehicles, 8, 21  
Gun emplacement, 53  
Gunnery skill rating, 15  
Gyroscope critical hit, 37
- H**  
Hatchets, 40, 128  
Heat  
  and damage modifiers, 30-31  
  effects of, 47-48  
  and four-legged BattleMechs, 77  
  and Gauss rifle, 128  
  and infernos, 131  
  and jumping, 19  
  phase, 14  
  points, 46-47  
  points table, 47  
  recording build-up, 47  
  and movement, 19-20  
Heat Scale, 10, 15  
Heat sink, 47, 112-13, 128  
Heavy lasers, 128-29  
Heavy woods, 11  
  intervening, 26  
  weapon firing and, 30  
Hexsides, 17  
Hidden units, 67, 77-78  
Hills  
  charge attacks, 41  
  intervening, 26  
  miniatures rules for, 91  
Hit location, 31  
  and attack direction, 31, 33  
  and combat within building, 52  
  critical hits, 35  
  determining, 33  
Hit location, table, 33  
  four-legged BattleMechs, 77  
  ground vehicles, 56  
  naval combat, 57  
  swarm, 68  
  VTOL, 58  
Hostile environments, 78-80  
Hovercraft, 8, 56  
Hull breach, 83  
Hull integrity, 79-80, 89  
Hydrofoils, 8
- I**  
Ice, 78  
Immobile target, 16, 31  
Indirect fire, 71  
Infantry, 59-66  
  accidental falls and, 45  
  anti-BattleMech, 44, 67-68  
  attacker movement and, 29  
  battle armor, 60-61  
  building levels and, 51  
  carriers, 59  
  combat, 60-63  
  costs, 137  
  damage table, 60  
  destruction of, 38  
  elevation change, 17  
  hit location, 33  
  Inner Sphere suits, 63-66  
  inside buildings, 51-52  
  mounting and dismounting, 59  
  movement, 17, 18, 59-60  
  multiple targets and, 30  
  munitions, 130  
  range modifier table, 60  
  record sheet, 10  
  stacking, 20, 94  
  units, 9  
  units table, 59  
Infernos, 131, 148  
Inner Sphere  
  background on, 5  
  battle armor, 63-66, 147  
  BattleMech assignment tables, 105-6  
  weapons and equipment, 115-16  
  weapons and equipment  
    battle value, 143  
Internal structure, 119
- J-K**  
Jumping, 19  
  capability, 112  
  heat effects on, 47  
  heat points for, 46  
  ice and, 78  
  infantry, 9  
  leg hit and, 37  
Jump jets, 121  
Kick attacks, 40-41, 146
- L**  
Lasers, 128-29  
LB-X autocannon, 124, 134  
Leg  
  attacks, 67  
  critical hit, 36-37  
  damage, four-legged BattleMechs, 77  
  destruction, 34  
  hits, 35  
  -mounted weapons, 28  
Light woods, 11  
  intervening, 26  
  weapon firing and, 30  
Line of sight, 25-27  
  miniatures rules, 94-95  
  underwater, 88, 89  
Location, damage, 10  
Long-range missile, 129  
  Artemis, 123  
  C<sup>3</sup> computer, 125  
  hit location, 33  
  indirect fire, 80  
Longinus armor, 65  
Lower arm actuator, 31
- M**  
Machine gun, 129  
Mapsheets, 10-12  
MASC (myomer accelerator  
  signal circuitry), 132-33, 143  
MechWarrior, 146  
  consciousness table, 16  
  damage, 15  
  heat effects on, 48  
  survival, 38  
Medium-range missile, 33, 129  
Minefields  
  clearing, 81  
  command-detonated, 80-81  
  conventional, 80  
  vibrabomb, 81  
Miniatures rules  
  conversions, 92-96  
  preparing, 90-91  
  terrain preparation, 91-92  
Minimum range modifier, 29  
Missile  
  hits, 31  
  launchers, 129-30  
  munitions, 130-32  
Movement, 13  
  actions, 19-20  
  basics, 17  
  buildings effects on, 50-51  
  cost table, 18  
  direction, 17  
  facing, 17-18  
  heat effects on, 47  
  miniatures and, 93-94  
  minimum, 20  
  modes, 18-19  
  pavement, 20-22  
  piloting skill rolls, 22-24  
  stacking, 20  
  underwater, 88  
  vehicles, 54-56  
Multiple targets modifier, 30
- N-O**  
Narc missile beacon, 133  
Naval combat, 56  
  critical hits table, 57  
  hit location table, 57  
Naval movement, 56  
Naval vessels, 8-9  
Night combat, 81  
Obstructions, 94  
Off-board, 70  
OmniMechs, 7-8, 114, 120-21  
OmniVehicles, 120
- P**  
Partial cover, 26, 30  
Particle projector cannon, 133  
Pavement, 11, 20-22  
Physical attack, 14, 39-44  
  multiple targets, 30  
  piloting skill rolls, 22  
Piloting skill rolls, 15-16, 22-24, 77  
Probe, active, 122  
Prone BattleMechs, 28  
  attack by and against, 44  
  attacking, 31  
  firing when down, 31  
  movement, 17  
  reversing arms, 82

# INDEX

swarming and, 68  
Pulse lasers, 129  
Punch attack, 39, 44  
Push attacks, 40

## R

Range, 29, 95  
Repair, 85  
    diagnosis and, 82-83  
    extra time for, 87  
    master table, 86  
    partial, 85, 87  
    replacement parts, 83-84  
    rush jobs, 87  
    technician and, 82  
Roads, 11, 20-21  
    miniatures rules, 92  
    VTOLs and, 55  
Rough terrain, 11  
Rubble, 12  
Rules changes, 146-48  
Running, 19

## S

Salvage, 37, 120  
Scale, 92-93  
Scavenging, 84-85  
Scenarios  
    general rules, 97-98  
    mapsheet selection, 100-102  
    movement and retreat, 97  
    number of players, 97  
    set-up, 97  
    unit generation, 102-8  
Searchlights, 81  
Shell flight table, 70  
Short-range missile, 33, 129  
Shoulder actuators, 40  
Sideslipping, VTOL, 55  
Sinkholes, 11  
Skidding, 21-22  
Skill improvement, 15  
Skill level multipliers, 144  
Skills table, 15, 108  
Skills, warriors, 14-15  
Slot, definition of, 10  
Smoke, 12, 75  
    miniatures rules, 92  
    rounds, 71  
Special case rules, 67-89  
Stacking, 20, 43  
    anti-BattleMech infantry, 67  
    building levels and, 51  
    infantry, 59  
    miniatures rules, 94  
Standing still, 18  
Standing up, 20  
Streak short-range missiles, 129-30  
Submarines, 9  
    movement, 56  
    stacking, 20  
Surface naval vessels, 8  
Swamp, 79, 92  
Swarm attacks, 67-68  
    hit location table, 68  
    long-range missiles, 131-32  
Sword, 40, 133-34

## T

TAG (target acquisition gear), 125, 134, 143  
Targeting computer, 124, 134  
Target movement modifier, 29-30  
Technician  
    exclusivity of, 82  
    experience table, 82  
    types, 82  
Technology base, 119  
Temperatures, extreme, 78  
Terrain, 10-12  
    conversion table, 72  
    gridded, 92  
    ice-covered, 78  
    improved positions in, 80  
    intervening, 25-26  
    mapsheet tables, 101  
    miniatures rules, 91-92  
    modifiers, 30  
    movement in, 17  
    partial cover by, 26  
Thrashing attacks, prone, 44  
To-hit modifiers, 32  
To-hit roll, 31  
Torpedoes, 89, 130  
Torso  
    critical hit, 36, 37  
    destruction, 34  
    hits, 35-36  
    twist, 25, 77  
Tracked vehicles, 8  
Triple-strength myomer, 134  
Turret rotation, 25, 77  
Turrets, 53, 120

## U

Ultra autocannon, 124, 134  
Underwater operations  
    attacks, 27, 89  
    line of sight, 88, 89  
    movement, 88  
    range table, 89  
    weapon 88-89  
Units, 7  
    destruction of, 38  
    displacement, 44-45  
    generation of, 102-8  
    intervening, 26  
    unequal number of, 14

## V

Vacuum, 79-80  
Vehicles, 54-58  
    accidental falls and, 45  
    basement fall by, 53  
    building levels and, 51  
    CASE, 126  
    charge attacks, 41  
    construction, 118-20  
    costs, 137  
    critical hits, 35, 56  
    damage to, 43  
    destruction of, 38  
    elevation change, 17  
    flamer, 127  
    heat and, 46  
    heat sinks, 128

hit location, 33  
hit location table, 56  
movement, 18, 54-56  
naval movement, 147  
piloting skill rolls, 22  
record sheet, 10  
recording damage, 33  
skidding, 21  
space limits, 118  
turret rotation, 25, 28  
unit displacement, 45  
VTOL combat, 147  
water hexes and, 27  
XL engine, 135  
Vibrabomb, 81  
VTOL (Vertical take-off and landing), 8, 20  
    artillery damage, 71  
    attacks against, 58  
    combat, 147  
    crashing, 55  
    critical hits, 58  
    engine damage, 57  
    explosions, 55, 58  
    hit location table, 58  
    movement, 54-55  
    rotor destruction, 57  
    sideslipping, 55

## W-X

Walking, 18-19  
Warrior  
    data, 10  
    MechWarrior damage, 15  
    skill improvement, 15  
    skills, 14-15  
Water  
    artillery damage, 71  
    combat and, 25  
    heat and, 47  
    hexes, 11, 27  
    intervening, 26  
    miniatures rules, 91-92  
    movement in, 17, 19  
    swarming and, 68  
    weapon firing and, 30  
Weapon attack, 13-14  
    ammunition expenditure, 27  
    firing arcs, 27-28  
    heat effects on, 47  
    piloting skill rolls, 22  
    underwater, 88-89  
Weapon firing  
    base-to-hit number, 28  
    modified to-hit number, 29  
    to-hit modifier, 29-31  
Weapons, 113-14, 119-20  
    Clan, 116-17  
    costs, 138  
    critical hit, 38  
    Inner Sphere, 115-16  
Wheeled vehicles, 8  
Woods, 11  
    clearing, 72  
    combat and, 25  
XL engine, 134-35

# BATTLETECH®

## BATTLEMECH RECORD SHEET

### ARMOR DIAGRAM

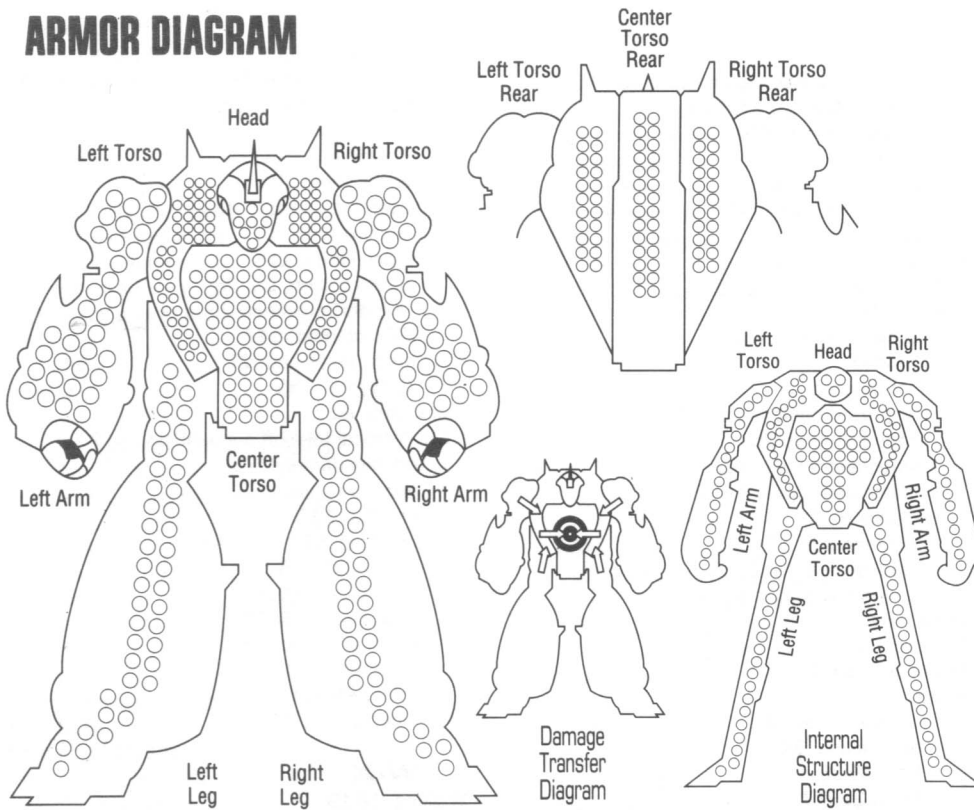

### Mech Data

Type: \_\_\_\_\_ Tonnage: \_\_\_\_\_  
 Movement Points: \_\_\_\_\_ Technology Base: \_\_\_\_\_  
 Walking: \_\_\_\_\_  Clan  
 Running: \_\_\_\_\_  Inner Sphere  
 Jumping: \_\_\_\_\_  Inner Sphere

### Weapons Inventory

Type	Location	Heat	Damage	Min.	Short	Med.	Long

Total Heat Sinks: \_\_\_\_ ( \_\_\_\_ )

Single  Double  
 Operational  Disabled

### Warrior Data

Name: \_\_\_\_\_  
 Gunnery Skill: \_\_\_\_\_ Piloting Skill: \_\_\_\_\_  
 Hits Taken: 

1	2	3	4	5	6
---	---	---	---	---	---

  
 Consciousness #: 

3	5	7	10	11	Dead
---	---	---	----	----	------

### Heat Scale

Heat Overflow	Effect
30	Shutdown
29	
28	Ammo Explosion, avoid on 8+
27	
26	Shutdown, avoid on 10+
25	-5 Movement Points
24	+4 Modifier to Fire
23	Ammo Explosion, avoid on 6+
22	Shutdown, avoid on 8+
21	
20	-4 Movement Points
19	Ammo Explosion, avoid on 4+
18	Shutdown, avoid on 6+
17	+3 Modifier to Fire
16	
15	-3 Movement Points
14	Shutdown, avoid on 4+
13	+2 Modifier to fire
12	
11	
10	-2 Movement Points
09	
08	+1 Modifier to Fire
07	
06	
05	-1 Movement Points
04	
03	
02	
01	
00	

### Critical Hit Table

- Left Arm**
- Shoulder
  - Upper Arm Actuator
  - Lower Arm Actuator
  - Hand Actuator
  - \_\_\_\_\_
  - \_\_\_\_\_
- 1-3**
- \_\_\_\_\_
  - \_\_\_\_\_
  - \_\_\_\_\_
  - \_\_\_\_\_
  - \_\_\_\_\_
  - \_\_\_\_\_
- 4-6**
- Left Torso**
- \_\_\_\_\_
  - \_\_\_\_\_
  - \_\_\_\_\_
  - \_\_\_\_\_
  - \_\_\_\_\_
  - \_\_\_\_\_
- 1-3**
- \_\_\_\_\_
  - \_\_\_\_\_
  - \_\_\_\_\_
  - \_\_\_\_\_
  - \_\_\_\_\_
  - \_\_\_\_\_
- 4-6**
- Left Leg**
- Hip
  - Upper Leg Actuator
  - Lower Leg Actuator
  - Foot Actuator
  - \_\_\_\_\_
  - \_\_\_\_\_

- Head**
- Life Support
  - Sensors
  - Cockpit
  - \_\_\_\_\_
  - Sensors
  - Life Support
- Center Torso**
- Engine
  - Engine
  - Engine
  - Gyro
  - Gyro
  - Gyro
- 1-3**
- Gyro
  - Engine
  - Engine
  - Engine
  - \_\_\_\_\_
  - \_\_\_\_\_
- 4-6**

- Right Arm**
- Shoulder
  - Upper Arm Actuator
  - Lower Arm Actuator
  - Hand Actuator
  - \_\_\_\_\_
  - \_\_\_\_\_
- 1-3**
- \_\_\_\_\_
  - \_\_\_\_\_
  - \_\_\_\_\_
  - \_\_\_\_\_
  - \_\_\_\_\_
  - \_\_\_\_\_
- 4-6**
- Right Torso**
- \_\_\_\_\_
  - \_\_\_\_\_
  - \_\_\_\_\_
  - \_\_\_\_\_
  - \_\_\_\_\_
  - \_\_\_\_\_
- 1-3**
- \_\_\_\_\_
  - \_\_\_\_\_
  - \_\_\_\_\_
  - \_\_\_\_\_
  - \_\_\_\_\_
  - \_\_\_\_\_
- 4-6**
- Right Leg**
- Hip
  - Upper Leg Actuator
  - Lower Leg Actuator
  - Foot Actuator
  - \_\_\_\_\_
  - \_\_\_\_\_

**Engine Hits** ○ ○ ○  
**Gyro Hits** ○ ○ ○  
**Sensor Hits** ○ ○ ○  
**Life Support** ○

Battle Value \_\_\_\_\_  
 Cost \_\_\_\_\_

# BATTLETECH®

## BATTLEMECH RECORD SHEET

### ARMOR DIAGRAM

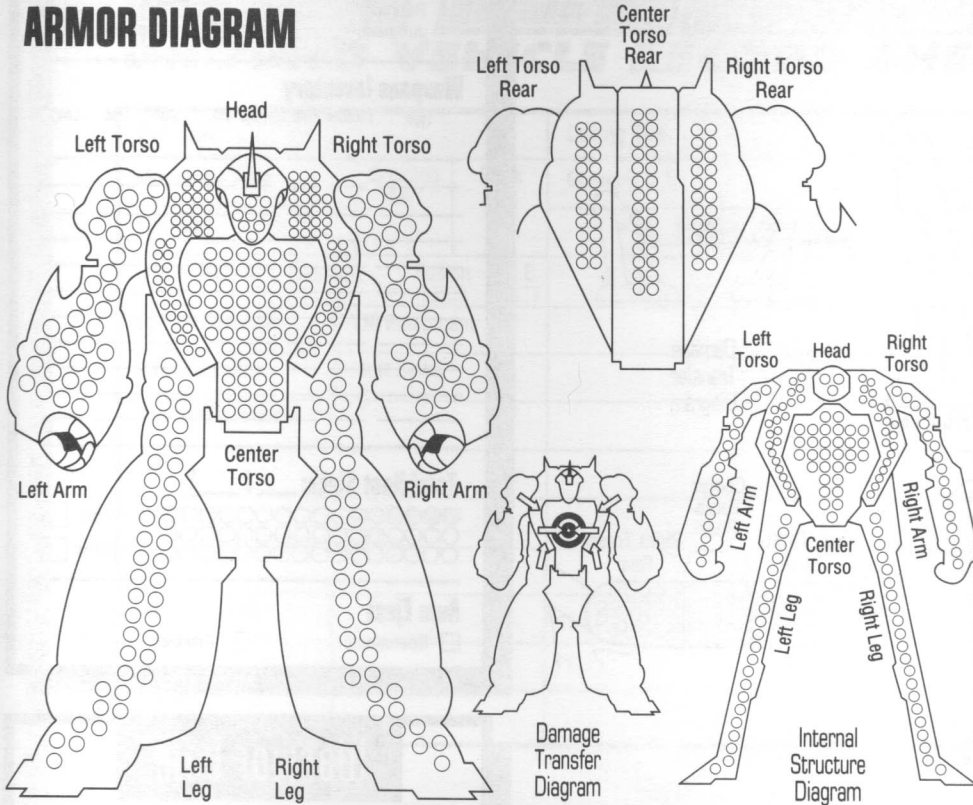

### Mech Data

Type: \_\_\_\_\_ Tonnage: \_\_\_\_\_  
 Movement Points: \_\_\_\_\_ Technology Base: \_\_\_\_\_  
 Walking: \_\_\_\_\_  Clan  
 Running: \_\_\_\_\_  Inner Sphere  
 Jumping: \_\_\_\_\_  Inner Sphere

### Weapons Inventory

Type	Location	Heat	Damage	Min.	Short	Med.	Long

Total Heat Sinks: \_\_\_\_ ( \_\_\_\_ )

Single  Double  
 Operational  Disabled

### Auto Eject

Operational  Disabled

### Warrior Data

Name: \_\_\_\_\_  
 Gunnery Skill: \_\_\_\_\_ Piloting Skill: \_\_\_\_\_  
 Hits Taken: 

1	2	3	4	5	6
---	---	---	---	---	---

  
 Consciousness #: 

3	5	7	10	11	Dead
---	---	---	----	----	------

### Critical Hit Table

#### Left Arm

- Shoulder
  - Upper Arm Actuator
  - Lower Arm Actuator
  - Hand Actuator
  - \_\_\_\_\_
  - \_\_\_\_\_
- 1-3 \_\_\_\_\_
- 4-6 \_\_\_\_\_

#### Head

- Life Support
- Sensors
- Cockpit
- \_\_\_\_\_
- Sensors
- Life Support

#### Right Arm

- Shoulder
  - Upper Arm Actuator
  - Lower Arm Actuator
  - Hand Actuator
  - \_\_\_\_\_
  - \_\_\_\_\_
- 1-3 \_\_\_\_\_
- 4-6 \_\_\_\_\_

#### Left Torso

- \_\_\_\_\_
  - \_\_\_\_\_
  - \_\_\_\_\_
  - \_\_\_\_\_
  - \_\_\_\_\_
  - \_\_\_\_\_
- 1-3 \_\_\_\_\_
- 4-6 \_\_\_\_\_

#### Center Torso

- Engine
  - Engine
  - Engine
  - Gyro
  - Gyro
  - Gyro
- 1-3 \_\_\_\_\_
- Gyro
  - Engine
  - Engine
  - Engine
  - \_\_\_\_\_
  - \_\_\_\_\_
- 4-6 \_\_\_\_\_

#### Right Torso

- \_\_\_\_\_
  - \_\_\_\_\_
  - \_\_\_\_\_
  - \_\_\_\_\_
  - \_\_\_\_\_
  - \_\_\_\_\_
- 1-3 \_\_\_\_\_
- 4-6 \_\_\_\_\_

#### Left Leg

- Hip
- Upper Leg Actuator
- Lower Leg Actuator
- Foot Actuator
- \_\_\_\_\_
- \_\_\_\_\_

**Engine Hits** ○ ○ ○  
**Gyro Hits** ○ ○ ○  
**Sensor Hits** ○ ○ ○  
**Life Support** ○

Battle Value \_\_\_\_\_  
 Cost \_\_\_\_\_

#### Right Leg

- Hip
- Upper Leg Actuator
- Lower Leg Actuator
- Foot Actuator
- \_\_\_\_\_
- \_\_\_\_\_

### Heat Scale

Heat Overflow

30	Shutdown
29	
28	Ammo Explosion, avoid on 8+
27	
26	Shutdown, avoid on 10+
25	-5 Movement Points
24	+4 Modifier to Fire
23	Ammo Explosion, avoid on 6+
22	Shutdown, avoid on 8+
21	
20	-4 Movement Points
19	Ammo Explosion, avoid on 4+
18	Shutdown, avoid on 6+
17	+3 Modifier to Fire
16	
15	-3 Movement Points
14	Shutdown, avoid on 4+
13	+2 Modifier to fire
12	
11	
10	-2 Movement Points
09	
08	+1 Modifier to Fire
07	
06	
05	-1 Movement Points
04	
03	
02	
01	
00	



# BATTLETECH®

## GROUND VEHICLE RECORD SHEET

Unit Type:			Driving Skill:		
Movement Type:	Cruising MP:	Flank MP:	Gunnery Skill:		
Tonnage:			<b>Weapons and Ammo</b>		
Engine Rating:	Tonnage:	Fusion I.C.E.			
Control Tonnage:	Lift Equipment:				
Power Amplifier:	Heat Sinks:				
Internal Structure:					
Turret:					
Armor tons:	Armor points:				
Front:					
Left/Right side:	/				
Rear:					
Turret:					

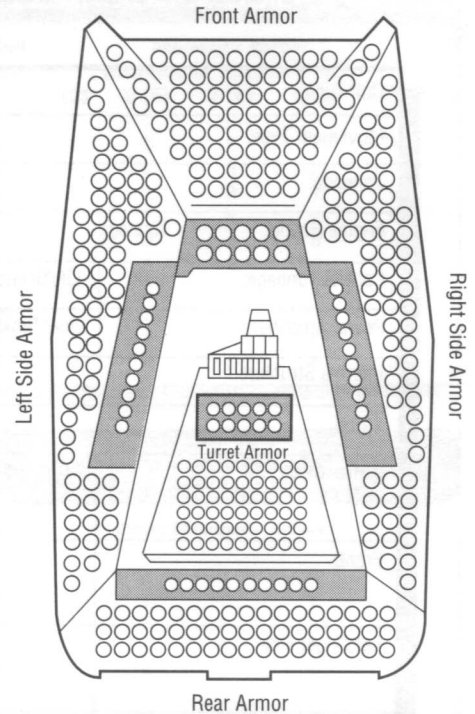

# BATTLETECH®

## V.T.O.L. RECORD SHEET

Unit Type:			Driving Skill:		
Movement Type: VTOL	Cruising MP:	Flanking MP:	Gunnery Skill:		
Tonnage:			<b>Weapons and Ammo</b>	Turn	Elev.
Engine Rating:	Tonnage:	Fusion I.C.E.		1	
Control Tonnage:	Lift Equipment:		2		
Power Amplifier:	Heat Sinks:		3		
Internal Structure:			4		
			5		
Armor tons:	Armor points:		6		
Front:			7		
Left/Right side:	/		8		
Rear:			9		
Rotor:			10		

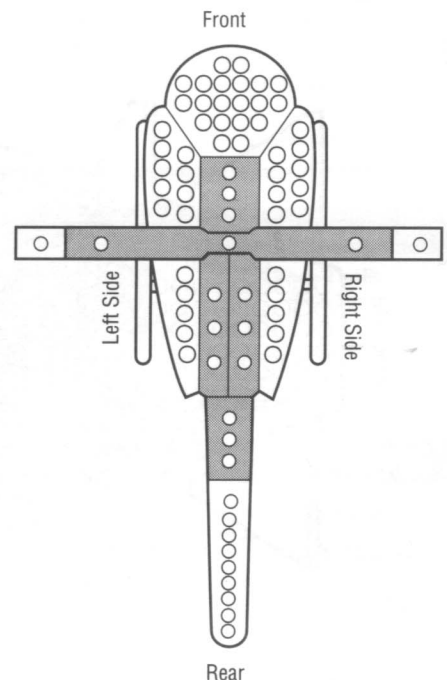

# BATTLETECH®

## NAVAL RECORD SHEET

Unit Type:				Driving Skill:		
Movement Type:		Cruising MP:	Flanking MP:	Gunnery Skill:		
Tonnage:				<b>Weapons and Ammo</b>		Turn
Engine Rating:	Tonnage:	Fusion	I.C.E.			<b>1</b>
Control Tonnage:		Lift/Diving Equipment:				<b>2</b>
Power Amplifier:		Heat Sinks:				<b>3</b>
Internal Structure:						<b>4</b>
Turret:						<b>5</b>
Armor tons:		Armor points:				<b>6</b>
						<b>7</b>
Front:						<b>8</b>
						<b>9</b>
Left/Right side:						<b>10</b>
						<b>11</b>
Rear:						<b>12</b>
						<b>13</b>
Turret:						<b>14</b>
						<b>14</b>

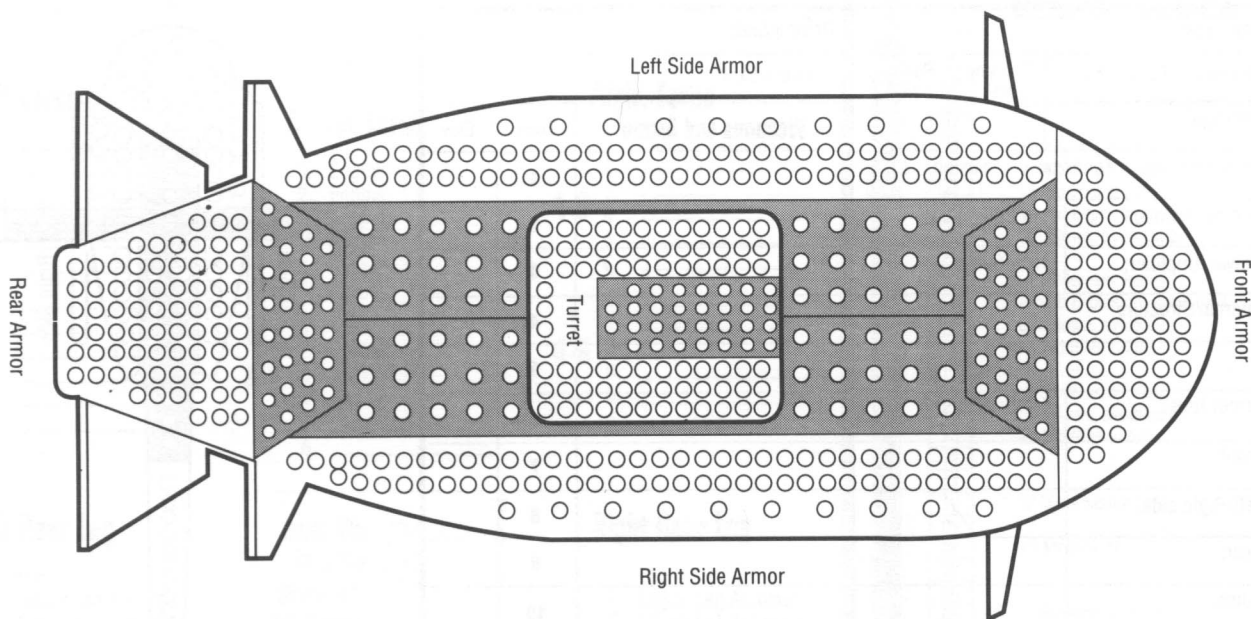

# BATTLETECH® BATTLE ARMOR RECORD FORM

STAR NUMBER \_\_\_\_\_

STAR NUMBER \_\_\_\_\_

**POINT NUMBER** 1  
**TYPE**

1	15	14	13	12	11	10	09	08	07	06	05	04	03	02	01	00
2	15	14	13	12	11	10	09	08	07	06	05	04	03	02	01	00
3	15	14	13	12	11	10	09	08	07	06	05	04	03	02	01	00
4	15	14	13	12	11	10	09	08	07	06	05	04	03	02	01	00
5	15	14	13	12	11	10	09	08	07	06	05	04	03	02	01	00

WEAPON TYPE A \_\_\_\_\_  
WEAPON TYPE B \_\_\_\_\_  
 SALVO 1  SALVO 2

**POINT NUMBER** 1  
**TYPE**

1	15	14	13	12	11	10	09	08	07	06	05	04	03	02	01	00
2	15	14	13	12	11	10	09	08	07	06	05	04	03	02	01	00
3	15	14	13	12	11	10	09	08	07	06	05	04	03	02	01	00
4	15	14	13	12	11	10	09	08	07	06	05	04	03	02	01	00
5	15	14	13	12	11	10	09	08	07	06	05	04	03	02	01	00

WEAPON TYPE A \_\_\_\_\_  
WEAPON TYPE B \_\_\_\_\_  
 SALVO 1  SALVO 2

## BATTLE ARMOR MISSILES TABLE

Die Roll (2D6)	Members Active (Number of Missiles Fired)				
	(2)	2 (4)	3 (6)	4 (8)	5 (10)
2	1	1	2	2	3
3	1	2	2	3	3
4	1	2	3	3	4
5	1	2	3	4	6
6	1	2	4	4	6
7	1	3	4	5	6
8	2	3	4	5	6
9	2	3	5	6	8
10	2	3	5	7	8
11	2	4	6	8	10
12	2	4	6	8	10

**POINT NUMBER** 2  
**TYPE**

1	15	14	13	12	11	10	09	08	07	06	05	04	03	02	01	00
2	15	14	13	12	11	10	09	08	07	06	05	04	03	02	01	00
3	15	14	13	12	11	10	09	08	07	06	05	04	03	02	01	00
4	15	14	13	12	11	10	09	08	07	06	05	04	03	02	01	00
5	15	14	13	12	11	10	09	08	07	06	05	04	03	02	01	00

WEAPON TYPE A \_\_\_\_\_  
WEAPON TYPE B \_\_\_\_\_  
 SALVO 1  SALVO 2

**POINT NUMBER** 2  
**TYPE**

1	15	14	13	12	11	10	09	08	07	06	05	04	03	02	01	00
2	15	14	13	12	11	10	09	08	07	06	05	04	03	02	01	00
3	15	14	13	12	11	10	09	08	07	06	05	04	03	02	01	00
4	15	14	13	12	11	10	09	08	07	06	05	04	03	02	01	00
5	15	14	13	12	11	10	09	08	07	06	05	04	03	02	01	00

WEAPON TYPE A \_\_\_\_\_  
WEAPON TYPE B \_\_\_\_\_  
 SALVO 1  SALVO 2

## BATTLE ARMOR ATTACK TABLE

Die Roll (2D6)	Point Members Active				
	1	2	3	4	5
2	1	1	1	1	1
3	1	1	1	2	2
4	1	1	2	2	2
5	1	1	2	2	3
6	1	1	2	2	3
7	1	2	2	3	3
8	1	2	2	3	4
9	1	2	3	3	4
10	1	2	3	4	4
11	1	2	3	4	5
12	1	2	3	4	5

**POINT NUMBER** 3  
**TYPE**

1	15	14	13	12	11	10	09	08	07	06	05	04	03	02	01	00
2	15	14	13	12	11	10	09	08	07	06	05	04	03	02	01	00
3	15	14	13	12	11	10	09	08	07	06	05	04	03	02	01	00
4	15	14	13	12	11	10	09	08	07	06	05	04	03	02	01	00
5	15	14	13	12	11	10	09	08	07	06	05	04	03	02	01	00

WEAPON TYPE A \_\_\_\_\_  
WEAPON TYPE B \_\_\_\_\_  
 SALVO 1  SALVO 2

**POINT NUMBER** 3  
**TYPE**

1	15	14	13	12	11	10	09	08	07	06	05	04	03	02	01	00
2	15	14	13	12	11	10	09	08	07	06	05	04	03	02	01	00
3	15	14	13	12	11	10	09	08	07	06	05	04	03	02	01	00
4	15	14	13	12	11	10	09	08	07	06	05	04	03	02	01	00
5	15	14	13	12	11	10	09	08	07	06	05	04	03	02	01	00

WEAPON TYPE A \_\_\_\_\_  
WEAPON TYPE B \_\_\_\_\_  
 SALVO 1  SALVO 2

## LEG ATTACKS TABLE

Battle Armored Troopers Active	Base To-Hit Number
4-5	4
3	7
2	10
1	12
—	No attack possible

**POINT NUMBER** 4  
**TYPE**

1	15	14	13	12	11	10	09	08	07	06	05	04	03	02	01	00
2	15	14	13	12	11	10	09	08	07	06	05	04	03	02	01	00
3	15	14	13	12	11	10	09	08	07	06	05	04	03	02	01	00
4	15	14	13	12	11	10	09	08	07	06	05	04	03	02	01	00
5	15	14	13	12	11	10	09	08	07	06	05	04	03	02	01	00

WEAPON TYPE A \_\_\_\_\_  
WEAPON TYPE B \_\_\_\_\_  
 SALVO 1  SALVO 2

**POINT NUMBER** 4  
**TYPE**

1	15	14	13	12	11	10	09	08	07	06	05	04	03	02	01	00
2	15	14	13	12	11	10	09	08	07	06	05	04	03	02	01	00
3	15	14	13	12	11	10	09	08	07	06	05	04	03	02	01	00
4	15	14	13	12	11	10	09	08	07	06	05	04	03	02	01	00
5	15	14	13	12	11	10	09	08	07	06	05	04	03	02	01	00

WEAPON TYPE A \_\_\_\_\_  
WEAPON TYPE B \_\_\_\_\_  
 SALVO 1  SALVO 2

## SWARM ATTACKS TABLE

Battle Armored Troopers Active	Base To-Hit Number
4-5	7
1-3	10
—	No attack possible

**POINT NUMBER** 5  
**TYPE**

1	15	14	13	12	11	10	09	08	07	06	05	04	03	02	01	00
2	15	14	13	12	11	10	09	08	07	06	05	04	03	02	01	00
3	15	14	13	12	11	10	09	08	07	06	05	04	03	02	01	00
4	15	14	13	12	11	10	09	08	07	06	05	04	03	02	01	00
5	15	14	13	12	11	10	09	08	07	06	05	04	03	02	01	00

WEAPON TYPE A \_\_\_\_\_  
WEAPON TYPE B \_\_\_\_\_  
 SALVO 1  SALVO 2

**POINT NUMBER** 5  
**TYPE**

1	15	14	13	12	11	10	09	08	07	06	05	04	03	02	01	00
2	15	14	13	12	11	10	09	08	07	06	05	04	03	02	01	00
3	15	14	13	12	11	10	09	08	07	06	05	04	03	02	01	00
4	15	14	13	12	11	10	09	08	07	06	05	04	03	02	01	00
5	15	14	13	12	11	10	09	08	07	06	05	04	03	02	01	00

WEAPON TYPE A \_\_\_\_\_  
WEAPON TYPE B \_\_\_\_\_  
 SALVO 1  SALVO 2

## SWARM HIT LOCATION TABLE

Die Roll (2D6)	Location	Die Roll (2D6)	Location
2	Head	7	Front Center Torso
3	Rear Center Torso	8	Left Arm
4	Rear Right Torso	9	Front Left Torso
5	Front Right Torso	10	Rear Left Torso
6	Right Arm	11	Rear Center Torso
		12	Head

# BATTLETECH®

## INFANTRY RECORD SHEET

Clan Platoons Start Here ▼

▼ Inner Sphere Jump Platoons Start Here

	28	27	26	25	24	23	22	21	20	19	18	17	16	15	14	13	12	11	10	9	8	7	6	5	4	3	2	1
Rifle Platoon	7	7	7	7	6	6	6	6	5	5	5	5	4	4	4	4	3	3	3	3	2	2	2	2	1	1	1	1
Machine Gun or Flamer Platoon	10	9	9	8	8	8	7	7	7	6	6	6	5	5	5	4	4	4	3	3	3	2	2	2	1	1	1	1
Laser or SRM Platoon	14	14	13	13	12	12	11	11	10	10	9	9	8	8	7	7	6	6	5	5	4	4	3	3	2	2	1	1

Clan Platoons Start Here ▼

▼ Inner Sphere Jump Platoons Start Here

	28	27	26	25	24	23	22	21	20	19	18	17	16	15	14	13	12	11	10	9	8	7	6	5	4	3	2	1
Rifle Platoon	7	7	7	7	6	6	6	6	5	5	5	5	4	4	4	4	3	3	3	3	2	2	2	2	1	1	1	1
Machine Gun or Flamer Platoon	10	9	9	8	8	8	7	7	7	6	6	6	5	5	5	4	4	4	3	3	3	2	2	2	1	1	1	1
Laser or SRM Platoon	14	14	13	13	12	12	11	11	10	10	9	9	8	8	7	7	6	6	5	5	4	4	3	3	2	2	1	1

Clan Platoons Start Here ▼

▼ Inner Sphere Jump Platoons Start Here

	28	27	26	25	24	23	22	21	20	19	18	17	16	15	14	13	12	11	10	9	8	7	6	5	4	3	2	1
Rifle Platoon	7	7	7	7	6	6	6	6	5	5	5	5	4	4	4	4	3	3	3	3	2	2	2	2	1	1	1	1
Machine Gun or Flamer Platoon	10	9	9	8	8	8	7	7	7	6	6	6	5	5	5	4	4	4	3	3	3	2	2	2	1	1	1	1
Laser or SRM Platoon	14	14	13	13	12	12	11	11	10	10	9	9	8	8	7	7	6	6	5	5	4	4	3	3	2	2	1	1

Clan Platoons Start Here ▼

▼ Inner Sphere Jump Platoons Start Here

	28	27	26	25	24	23	22	21	20	19	18	17	16	15	14	13	12	11	10	9	8	7	6	5	4	3	2	1
Rifle Platoon	7	7	7	7	6	6	6	6	5	5	5	5	4	4	4	4	3	3	3	3	2	2	2	2	1	1	1	1
Machine Gun or Flamer Platoon	10	9	9	8	8	8	7	7	7	6	6	6	5	5	5	4	4	4	3	3	3	2	2	2	1	1	1	1
Laser or SRM Platoon	14	14	13	13	12	12	11	11	10	10	9	9	8	8	7	7	6	6	5	5	4	4	3	3	2	2	1	1

Clan Platoons Start Here ▼

▼ Inner Sphere Jump Platoons Start Here

	28	27	26	25	24	23	22	21	20	19	18	17	16	15	14	13	12	11	10	9	8	7	6	5	4	3	2	1
Rifle Platoon	7	7	7	7	6	6	6	6	5	5	5	5	4	4	4	4	3	3	3	3	2	2	2	2	1	1	1	1
Machine Gun or Flamer Platoon	10	9	9	8	8	8	7	7	7	6	6	6	5	5	5	4	4	4	3	3	3	2	2	2	1	1	1	1
Laser or SRM Platoon	14	14	13	13	12	12	11	11	10	10	9	9	8	8	7	7	6	6	5	5	4	4	3	3	2	2	1	1

### LEG ATTACKS TABLE

Men in Platoon	Base To-Hit Number
28-22	4
21-16	7
15-10	10
9-5	12
4-1	No attack possible

### SWARM ATTACKS TABLE

Men in Platoon	Base To-Hit Number
28-22	7
21-16	10
15-1	No attack possible

### SWARM HIT LOCATION TABLE

Die Roll (2D6)	Location
2	Head
3	Rear Center Torso
4	Rear Right Torso
5	Front Right Torso
6	Right Arm
7	Front Center Torso
8	Left Arm
9	Front Left Torso
10	Rear Left Torso
11	Rear Center Torso
12	Head

### INFANTRY RANGE MODIFIER TABLE

Weapon Type	To-Hit Modifier (Range in Hexes)						
	0	1	2	3	4	5	6
Rifle	-2	0	+2	—	—	—	—
MG	-2	0	+2	+4	—	—	—
Flamer	-1	0	+2	—	—	—	—
Laser	-2	0	+2	+4	—	—	—
SRM	-1	0	0	+2	+2	+4	+4

## PILOTING SKILL ROLL TABLE

BattleMech's Situation	Modifier
<b>Damage to BattleMech</b>	
BattleMech takes 20+ Damage Points in one phase	+1
BattleMech reactor shuts down	+3 <sup>1</sup>
Leg/foot actuator destroyed	+1
Hip actuator destroyed	+2
Gyro hit	+3
Gyro destroyed	Automatic Fall
Leg destroyed	Automatic Fall
<b>Physical Attacks on BattleMech</b>	
BattleMech was kicked	0
BattleMech was pushed	0
BattleMech was successfully charged/death from above attack	+2
<b>Unit's Actions</b>	
BattleMech missed kick	0
BattleMech makes a successful charging attack	+2
BattleMech made death from above attack	+4 <sup>2</sup>
BattleMech entering Depth 1 Water hex	-1
BattleMech entering Depth 2 Water hex	0
BattleMech entering Depth 3+ Water hex	+1
BattleMech attempting to stand	0
BattleMech entering Rubble hex	0
Running unit moves after facing change while on pavement	See Skidding Movement, below
Flanking VTOL moves after facing change	See <i>Sideslipping</i> , p. 55
BattleMech jumping with damaged gyro or leg/foot/hip actuators	per Preexisting Damage, below
BattleMech jumping with destroyed leg	per Preexisting Damage, below
BattleMech running with damaged hip or gyro	per Preexisting Damage, below
<b>Special Case</b>	
MechWarrior trying to avoid damage when his BattleMech is falling	+1/level fallen
<b>Preexisting Damage</b>	
Per leg/foot actuator previously destroyed	+1
Per hip actuator previously destroyed	+2
Gyro previously hit	+3
Leg previously destroyed	+5 <sup>4</sup>

### Skidding Movement

Hexes Moved in Turn	Modifier
0-2	-1
3-4	0
5-7	+1
8-10	+2
11+	+4

### Building Movement<sup>3</sup>

Unit entering/leaving Light Building hex	0
Unit entering/leaving Medium Building hex	+1
Unit entering/leaving Heavy Building hex	+2
Unit entering/leaving Hardened Building hex	+5
<b>Hexes Moved in Turn</b>	
1-2	0
3-4	+1
5-6	+2
7-9	+3
10+	+4

<sup>1</sup>Only during the turn that the reactor shuts down. If the MechWarrior must make a Piloting Skill Roll for a Mech with a shut-down reactor, the BattleMech automatically falls.

<sup>2</sup>Automatic fall if death from above attack is unsuccessful.

<sup>3</sup>To avoid damage only. Does not result in a fall if Piloting Skill Roll fails. See *Buildings*, p. 49. Add an additional modifier of 1 if unit is charging or being charged (in addition to the +2 modifier normally required in that situation).

<sup>4</sup>Do not add modifiers for other damaged actuators in the leg.

## DETERMINING CRITICAL HITS TABLE

Die Roll (2D6)	Effect
2-7	No Critical Hit
8-9	Roll 1 Critical Hit Location
10-11	Roll 2 Critical Hit Locations
12	Head/Limb Blown Off/Roll 3 Critical Hit Locations*

\* Roll 3 critical hit locations if the attack strikes the torso.

## MISSILE HITS TABLE

Die Roll (2D6)	Number of Missiles Fired									
	2	3	4	5	6	9	10	12	15	20
2	1	1	1	1	2	3	3	4	5	6
3	1	1	2	2	2	3	3	4	5	6
4	1	1	2	2	3	4	4	5	6	9
5	1	2	2	3	3	5	6	8	9	12
6	1	2	2	3	4	5	6	8	9	12
7	1	2	3	3	4	5	6	8	9	12
8	2	2	3	3	4	5	6	8	9	12
9	2	2	3	4	5	7	8	10	12	16
10	2	3	3	4	5	7	8	10	12	16
11	2	3	4	5	6	9	10	12	15	20
12	2	3	4	5	6	9	10	12	15	20

## MOVEMENT COST TABLE

Terrain Type/Activity	MP Cost Per Hex	Prohibited Units
Clear	1	Naval
Paved/Road/Bridge	1 <sup>3</sup>	Naval
Rough	2	Wheeled, Naval
Light Woods	2	Wheeled, Hover, Naval
Heavy Woods	3	Ground, Naval
Water		
Depth 0	1	Naval
Depth 1	2 <sup>1</sup>	Infantry, Ground <sup>4</sup>
Depth 2+	4 <sup>1</sup>	Infantry, Ground <sup>4</sup>
Elevation Change (up or down)		
1 level	+1 ('Mechs, VTOL, Subs)	—
2 levels	+2 (Infantry, Ground)	—
3+ levels	+2 ('Mechs, VTOL, Subs)	Infantry, Ground
Rubble	2 <sup>1</sup>	'Mechs, Infantry, Ground
Light Building	2 <sup>2</sup>	Wheeled, Naval
Medium Building	3 <sup>2</sup>	Naval
Heavy Building	4 <sup>2</sup>	Naval
Hardened Building	5 <sup>2</sup>	Naval
Movement Actions		
Facing Change	1/hexside <sup>5</sup>	—
Dropping to the Ground	1	—
Standing Up	2/attempt	—

<sup>1</sup>Piloting Skill Roll required to prevent falling.

<sup>2</sup>Piloting Skill Roll required to prevent damage; infantry pay only 1 MP to enter or leave any building.

<sup>3</sup>If traveling along road; otherwise cost of underlying terrain.

<sup>4</sup>Hovercraft may enter all Water hexes.

<sup>5</sup>No cost for infantry.

## BATTLEMECH KICK LOCATION TABLE

Die Roll Result	Left Side	Front/Rear	Right Side
1-3	Left Leg	Right Leg	Right Leg
4-6	Left Leg	Left Leg	Right Leg

## FACING AFTER A FALL TABLE

Die Roll (1D6)	New Facing	Hit Location
1	Same Direction	Front
2	1 Hexside Right	Right Side
3	2 Hexsides Right	Right Side
4	Opposite Direction	Rear
5	2 Hexsides Left	Left Side
6	1 Hexside Left	Left Side

## BATTLEMECH PUNCH LOCATION TABLE

D6 Roll Result	Left Side	Front/Rear	Right Side
1	Left Torso	Left Arm	Right Torso
2	Left Torso	Left Torso	Right Torso
3	Center Torso	Center Torso	Center Torso
4	Left Arm	Right Torso	Right Arm
5	Left Arm	Right Arm	Right Arm
6	Head	Head	Head

## BATTLEMECH HIT LOCATION TABLE

Die Roll (2D6)	Left Side	Front/Rear	Right Side
2*	L. Torso (critical)	C. Torso (critical)	R. Torso (critical)
3	Left Leg	Right Arm	Right Leg
4	Left Arm	Right Arm	Right Arm
5	Left Arm	Right Leg	Right Arm
6	Left Leg	Right Torso	Right Leg
7	Left Torso	C. Torso	Right Torso
8	C. Torso	Left Torso	C. Torso
9	Right Torso	Left Leg	Left Torso
10	Right Arm	Left Arm	Left Arm
11	Right Leg	Left Arm	Left Leg
12	Head	Head	Head

\* A result of 2 may inflict a critical hit. Apply damage to the armor in that section in the normal manner, but the attacking player also rolls once on the Determining Critical Hits Table, p. 35.

## ATTACK MODIFIERS TABLE

### All Attacks: Weapons and Physical

Attacker	Modifier
<b>Movement*</b>	
Stationary	None
Walked	+1
Ran	+2
Jumped	+3
Prone	+2
<b>Terrain</b>	
Light Woods	+1 per intervening hex; +1 if target in Light Woods
Heavy Woods	+2 per intervening hex; +2 if target in Heavy Woods
<b>Water**</b>	
Depth 1	-1 to hit a BattleMech in Water hex; Partial Cover also applies +1 to hit for BattleMech firing from Water hex BattleMechs cannot fire into or out of Depth 2+ water +3 (use BattleMech Punch Location Table)
Depth 2	
Partial Cover	
<b>Target</b>	
Prone	-2 from adjacent hex; +1 from all others
Immobile	-4
Skidding	+2
<b>Movement</b>	
Moved 0-2 hexes	0
Moved 3-4 hexes	+1
Moved 5-6 hexes	+2
Moved 7-9 hexes	+3
Moved 10+ hexes	+4
Jumped	+1 additional
Is battle armor unit	+1
Is stuck in Swamp hex	-2

### Weapon Attacks Only

#### Attacker

BattleMech Damage	
Sensor Hit	+2
Shoulder Hit	+4 for weapons in arm, disregard other damaged actuators in arm
Upper or Lower Arm Actuator (each)	+1 for weapons in arm

#### Heat

0-7	None
8-12	+1
13-16	+2
17-23	+3
24+	+4

#### Making indirect LRM attack

#### Range and Terrain

<b>Range</b>	
Short	None
Medium	+2
Long	+4
Minimum Range	+1 at minimum range, additional +1 per hex less than minimum range

Attacker and target on different levels  
of same building (concealment)

+3

#### Target

Secondary target in forward arc

Secondary target in side or rear arc

+2

### Physical Attacks Only

#### Attacker

BattleMech Damage	
Shoulder Hit	No punching or hatchet/sword attack with arm; no clubbing attacks; +2 to pushing attack (each) half damage for punching attack with arm; +2 to clubbing attacks
Upper or Lower Arm Actuator Hit (each)	+2 to punching and hatchet/sword attack with arm; half damage for punching attack with arm; +2 to clubbing attacks
Hand Actuator Hit	+1 to punching attack with arm; no clubbing attacks; no hatchet/sword attacks with arm
Hip Actuator Hit	No kicking attacks
Upper or Lower Leg Actuator Hit (each)	+2 and half damage to kicking attack with leg
Foot Actuator Hit	+1 to kicking attack with leg

#### Target

Infantry

+3 to kicking and death from above attacks

#### Other Modifiers

Charging attack

Death from Above attack

\* Does not apply to infantry units.

\*\* See *Underwater Operations*, p. 88 for exceptions.

## GROUND VEHICLE HIT LOCATION TABLE

Die Roll (2D6)	Front/Rear	Side
2*	Armor (critical)	Armor (critical)
3	Armor <sup>1</sup>	Armor <sup>1</sup>
4	Armor <sup>2</sup>	Armor <sup>2</sup>
5	Armor <sup>3</sup>	Armor <sup>2</sup>
6	Armor	Armor
7	Armor	Armor
8	Armor	Armor
9	Armor	Armor <sup>3</sup>
10	Turret Armor	Turret Armor
11	Turret Armor <sup>4</sup>	Turret Armor <sup>4</sup>
12*	Turret Armor (critical)	Armor (critical)

**Note:** If there is no turret, then all turret hits become normal armor hits.

<sup>1</sup> A track, axle, or lift fan has been destroyed; the unit cannot move for the rest of the game. If a hovercraft suffers this hit while over Depth 1 or deeper water, it sinks and is destroyed.

<sup>2</sup> A drive, wheel, or air-skirt has been damaged; -1 Cruising MP for the rest of the game.

<sup>3</sup> If the vehicle is a hovercraft, an air-skirt has been damaged; -1 Cruising MP for the rest of the game. If not a hovercraft, no additional effect.

<sup>4</sup> The turret locks in its current position and cannot be moved for the rest of the game; it can only fire out of its current arc. If there is no turret, no additional effect.

\* A result of 2 or 12 may inflict a critical hit. Apply damage to the armor in that section in the normal manner, but the attacking player also rolls once on the *Determining Critical Hits Table*, p. 35.

## GROUND VEHICLE CRITICAL HITS TABLE

Die Roll (1D6)	Result
1	Crew Stunned (No actions for the rest of this turn and 2 more turns)
2	Main Weapon Jams (No fire from largest system for 1 turn)
3	Engine Hit (No movement for rest of game; if a hovercraft suffers this hit while over Depth 1 or deeper water, it sinks and is destroyed.)
4	Crew Killed (Vehicle out of game)
5	Fuel Tank Hit (Vehicle explodes)
6	Ammo/Power Plant Hit (Vehicle explodes)

## HEAT POINT TABLE

Activity	Heat Points
Walking	+1 per turn
Running	+2 per turn
Jumping	+1 per hex (minimum of 3 per turn)
Attempting to Stand	+1 per attempt
Weapons Fire	Per Weapons and Equipment Tables, p. 115
Heat Sink	-1 per operational heat sink -2 per operational double heat sink -1 additional per heat sink under water (maximum 6 points) -2 additional per double heat sink underwater (maximum 6 points)
First Engine Hit	+5 per turn
Second Engine Hit	+10 (total) per turn
Fire	
Walking through	+2 per hex
Standing in	+5 per turn

## BUILDING MODIFIERS TABLE

Building Type	Original CF	Piloting MP Cost*	Skill Modifier
Light	1-15	2	0
Medium	16-40	3	+1
Heavy	41-90	4	+2
Hardened	91-150	5	+5

\* Infantry pay only 1 MP to enter a Building hex, regardless of type.

## INFERNO AMMO EXPLOSION TABLE

Heat Level	Avoid Number
10	4+
14	6+
19	8+
23	10+
28	12

**FASA**  
CORPORATION

# THE FUTURE OF WARFARE IS HERE!

Welcome to the 31st century, a time of endless wars that rage across the known universe. These epic conflicts are won and lost by BattleMechs®, 30-foot-tall, humanoid titans of metal bristling with high-intensity lasers, rapid-fire autocannon and dozens of other lethal weapons; enough firepower to level entire city blocks. Your elite force of MechWarriors® drives these juggernauts into battle, blasting at your opponent's 'Mechs® in a deadly game of kill or be killed. Will they become instant legends, or forgotten casualties? Only your skill and luck will determine their fate.

Drawing on years of experience, this book combines the best of the BattleTech board game into a unified whole. BattleTech Master Rules is entirely restructured and streamlined; it is the same game, but like you've never seen it before. This book includes the complete game rules, a quick-and-easy scenario creation system, the Battle Value point system for evaluating 'Mechs and balancing forces, and revised and expanded miniatures rules.

**FASA**  
CORPORATION

# BATTLETECH®

BattleTech®, 'Mech®, BattleMech® and MechWarrior® are Registered Trademarks of FASA Corporation. BattleTech Master Rules™ is a Trademark of FASA Corporation. Copyright © 1998 FASA Corporation. All Rights Reserved. Printed in the USA.



ISBN# 1-55560-352-1 \$20.00